



US00D923513S

(12) **United States Design Patent**
Howe et al.

(10) **Patent No.:** **US D923,513 S**
(45) **Date of Patent:** **** Jun. 29, 2021**

- (54) **TRACKED VEHICLE** 3,017,942 A * 1/1962 Gamaunt B62D 55/0963
180/9.1
- (71) Applicant: **Howe and Howe Technologies, Inc.,** 3,545,837 A * 12/1970 Chapman F41G 1/3935
Waterboro, ME (US) 359/430
- (72) Inventors: **Michael Howe**, Limerick, ME (US); 4,433,634 A * 2/1984 Coast B60F 3/0061
Forrest Joel Tripp, Saco, ME (US); 180/9.1
Zachary E. Sawyer, Falmouth, ME 5,723,807 A * 3/1998 Kuhn, II F41H 5/013
(US); **Anthony Victor Castro**, Cape 89/36.02
Elizabeth, ME (US); **Michael J.** 8,474,554 B2 * 7/2013 Howe B62D 55/26
Zagorianakos, Gorham, ME (US) 180/9.62

(Continued)

(73) Assignee: **Howe & Howe Inc.**, Waterboro, ME (US)

(**) Term: **15 Years**

(21) Appl. No.: **29/709,303**

(22) Filed: **Oct. 13, 2019**

(51) **LOC (13) Cl.** **12-13**

(52) **U.S. Cl.**
USPC **D12/12**

(58) **Field of Classification Search**
USPC D12/1, 3, 12, 14-16, 51, 82, 85-88;
D21/433, 434, 504-505, 533, 539, 548,
D21/550-552, 557, 559, 763; 89/36.08,
89/36.13, 36.14, 37.03, 37.13, 40.03,
89/41.02, 41.12, 41.18, 45, 46;
296/181.1; D15/199
CPC B62D 55/00; B62D 55/14; B60K 17/00;
B60R 2021/132; B60Y 2200/124; B60Y
2200/20; B60Y 2200/24; B60Y 2200/25;
B60Y 2200/254; B60Y 2200/42; B60Y
2200/40; F41H 7/00; F41A 23/24; F41A
23/34

See application file for complete search history.

(56) **References Cited**

U.S. PATENT DOCUMENTS

- 2,859,068 A * 11/1958 Larsson B62D 55/30
305/134
- 2,860,715 A * 11/1958 Bouffort B62D 55/116
180/9.1

OTHER PUBLICATIONS

Ripsaw Luxury Super Tank, www.ripsawtank.com [online]. Published on or before Jul. 8, 2020, [retrieved on Jul. 8, 2020]. Retrieved from the Internet: <URL:http://www.ripsawtank.com/> (Year: 2020).*

Primary Examiner — Christian P. McLean

Assistant Examiner — Adam C Mager

(74) *Attorney, Agent, or Firm* — BainwoodHuang

(57) **CLAIM**

The ornamental design of for a tracked vehicle, as shown and described.

DESCRIPTION

FIG. 1 is a rear-corner, upper perspective view of a tracked vehicle showing our new design.
FIG. 2 is a side plan view thereof.
FIG. 3 is a rear plan view thereof.
FIG. 4 is a rear-corner view thereof.
FIG. 5 is a rear-corner lower perspective view thereof; and, FIG. 6 is a rear-corner upper perspective view thereof.
The broken lines represent portions of the tracked vehicle that form no part of the claimed design.

1 Claim, 4 Drawing Sheets

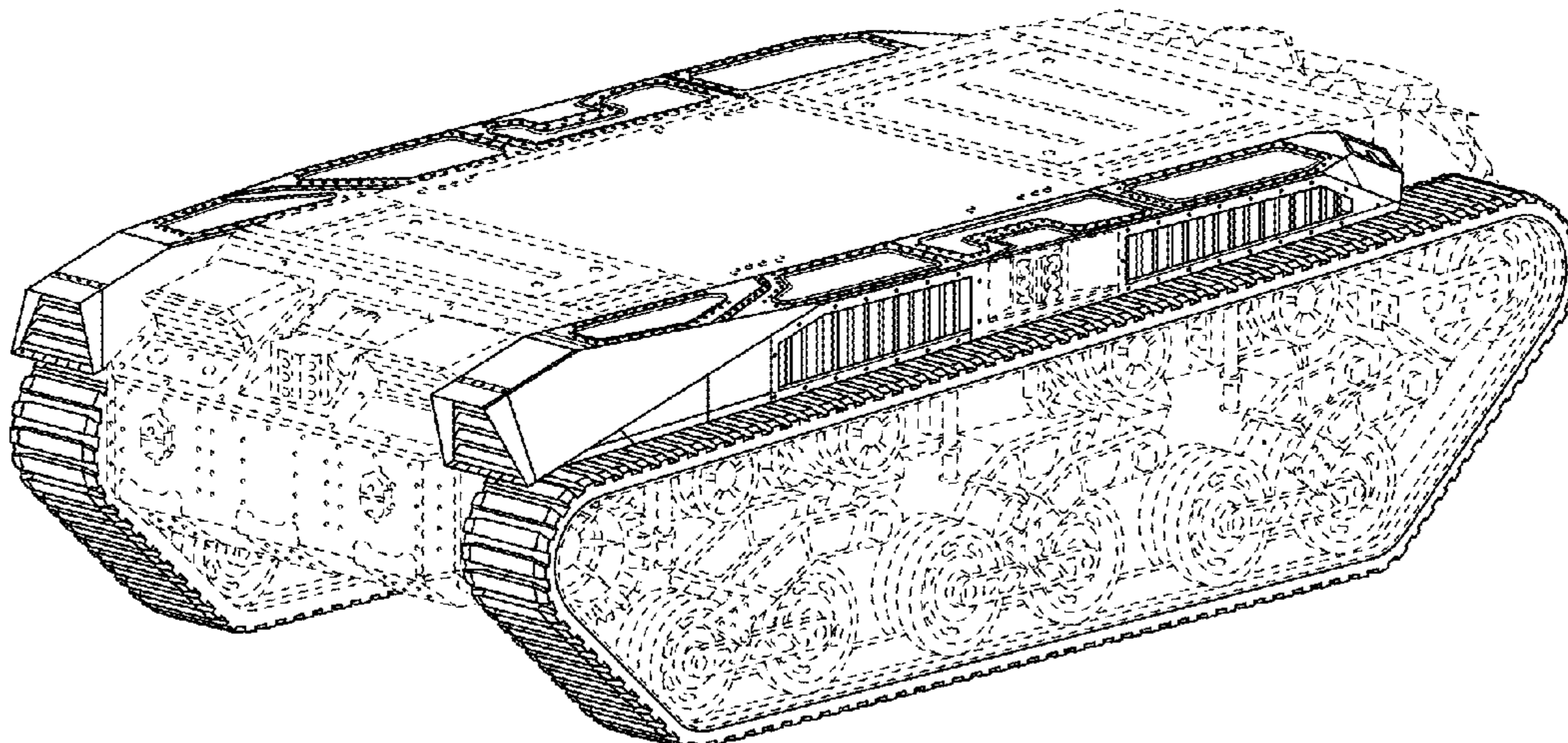

(56)

References Cited

U.S. PATENT DOCUMENTS

8,905,164	B1 *	12/2014	Capouellez	F41H 5/013 180/9.1
9,586,451	B2 *	3/2017	Baus	B60F 3/003
10,293,648	B2 *	5/2019	Coast	B60F 3/0038
10,392,059	B2 *	8/2019	Davis	B62D 55/108
2019/0315413	A1 *	10/2019	Howe	B62D 55/14

* cited by examiner

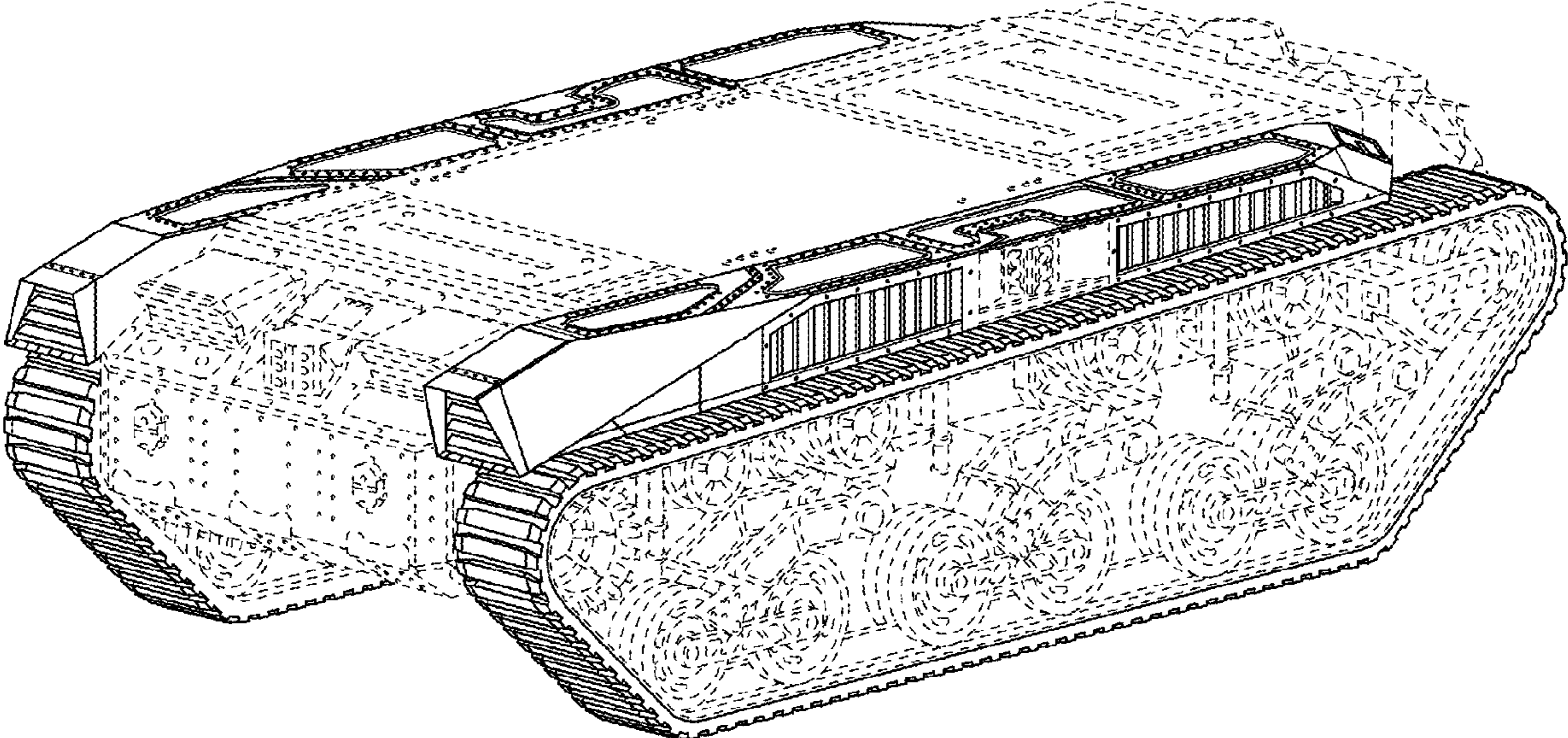

FIG. 1

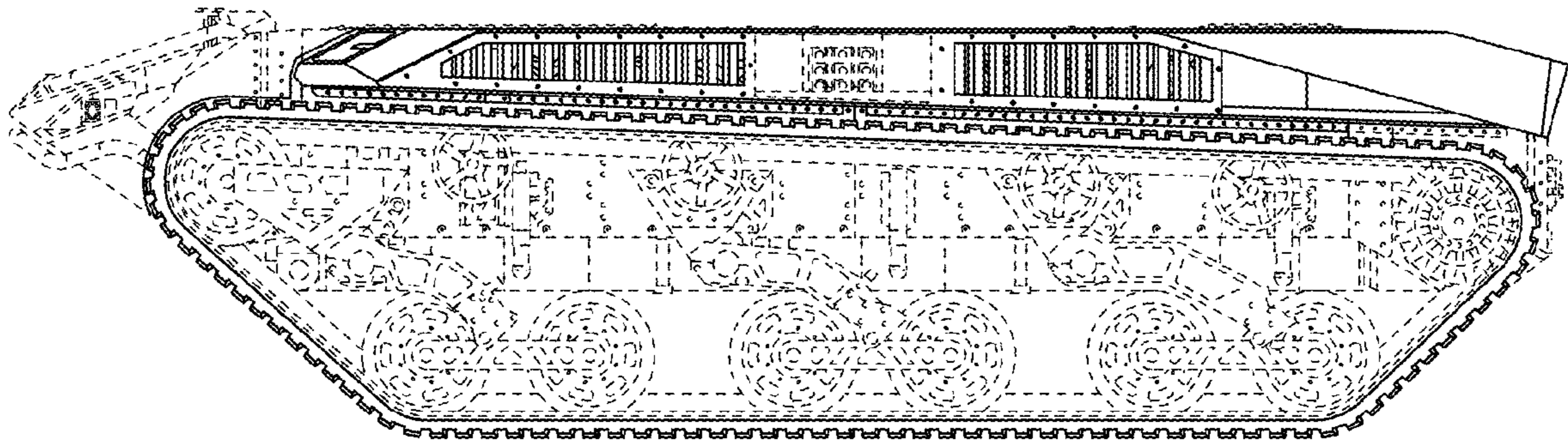

FIG. 2

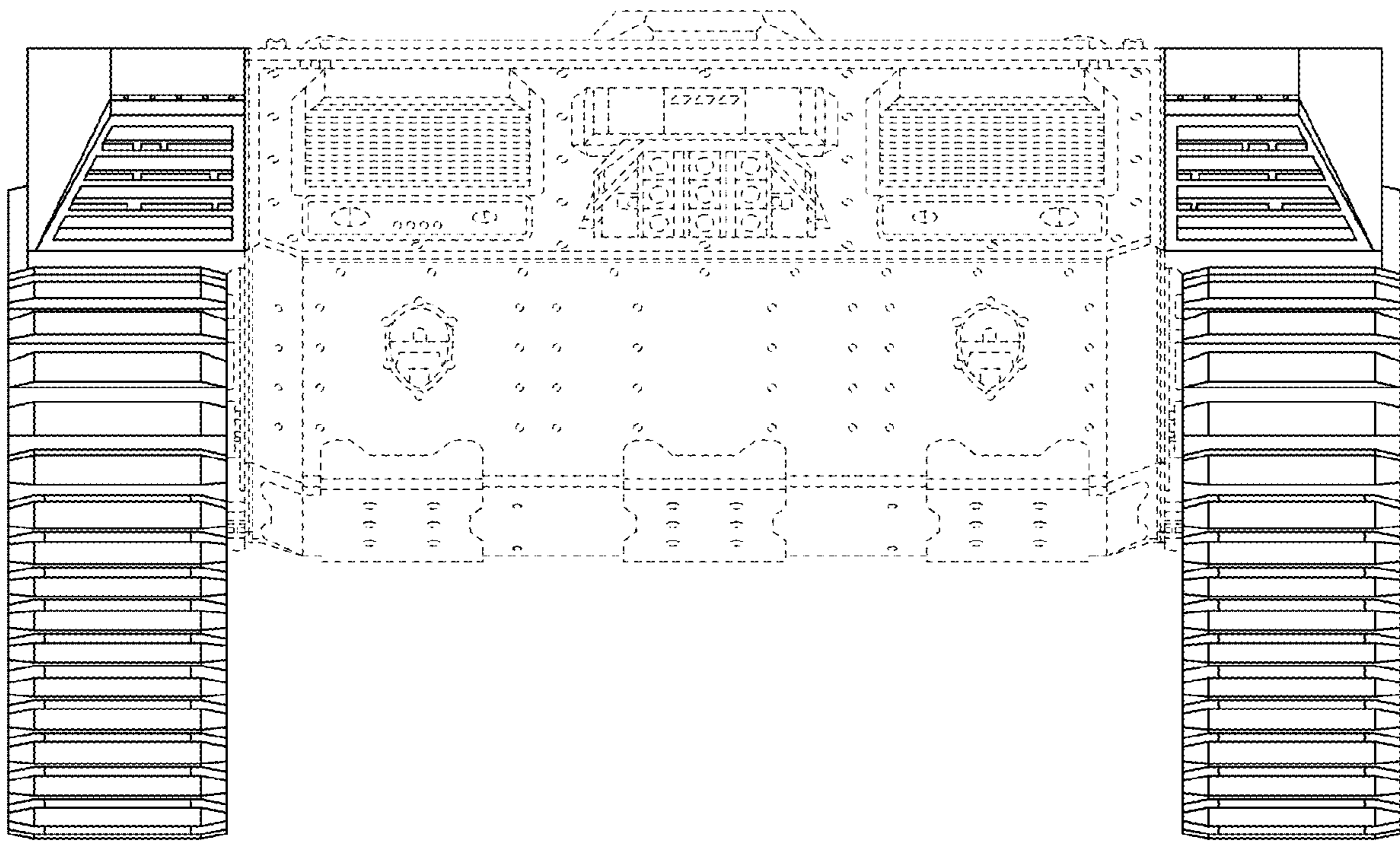

FIG. 3

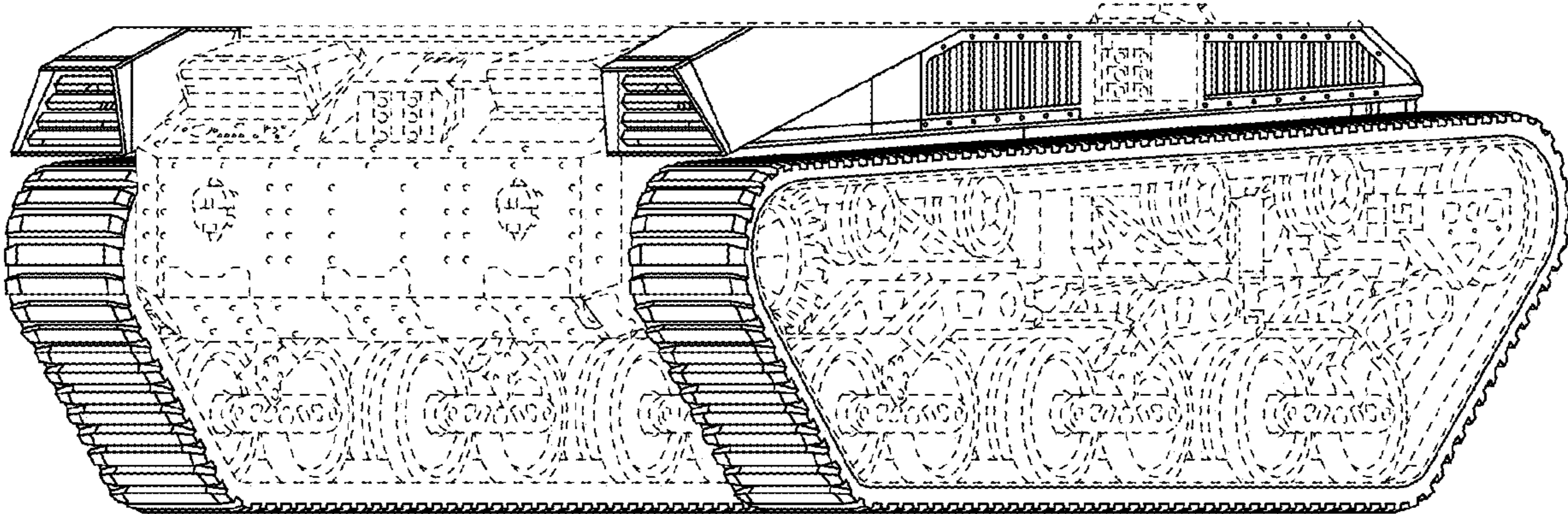

FIG. 4

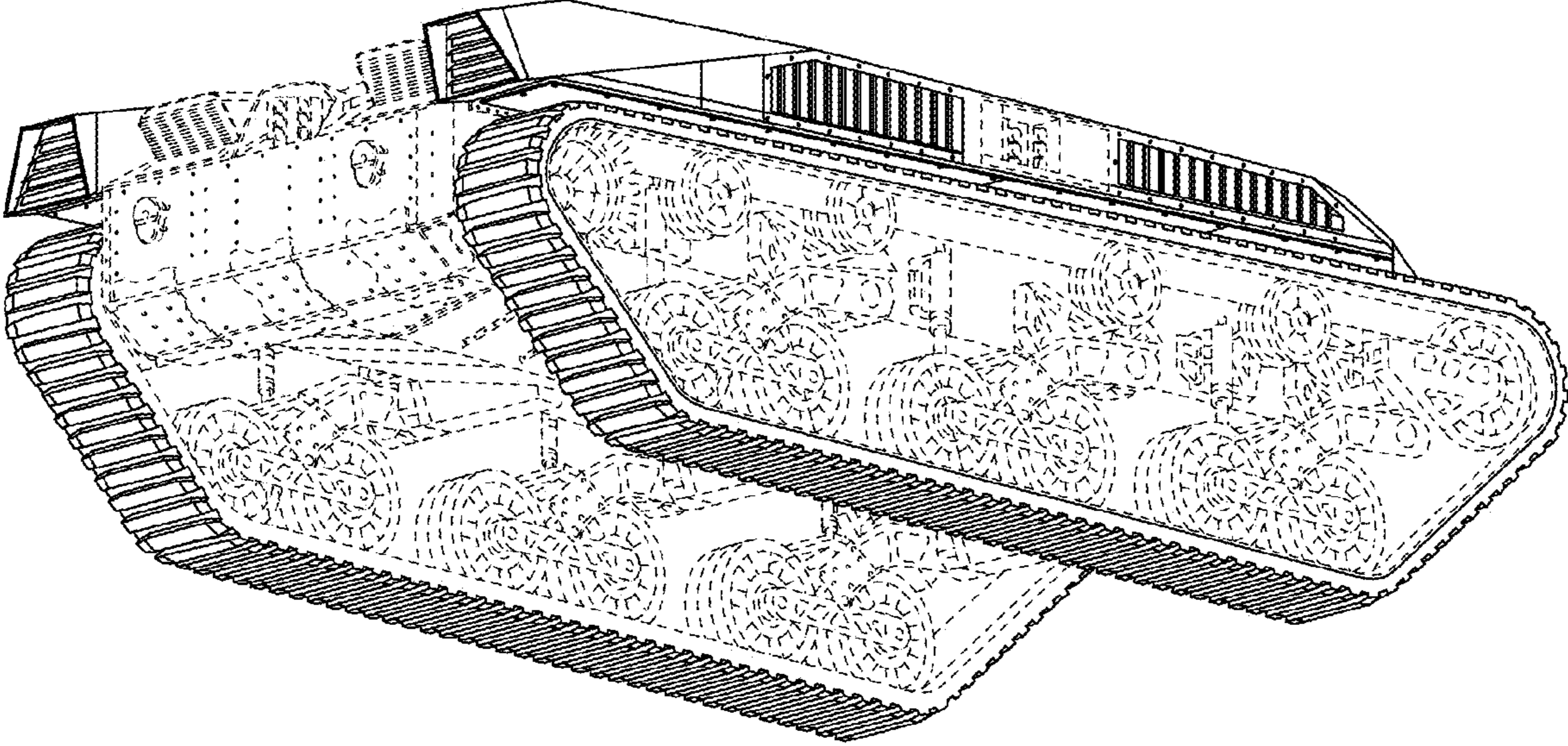

FIG. 5

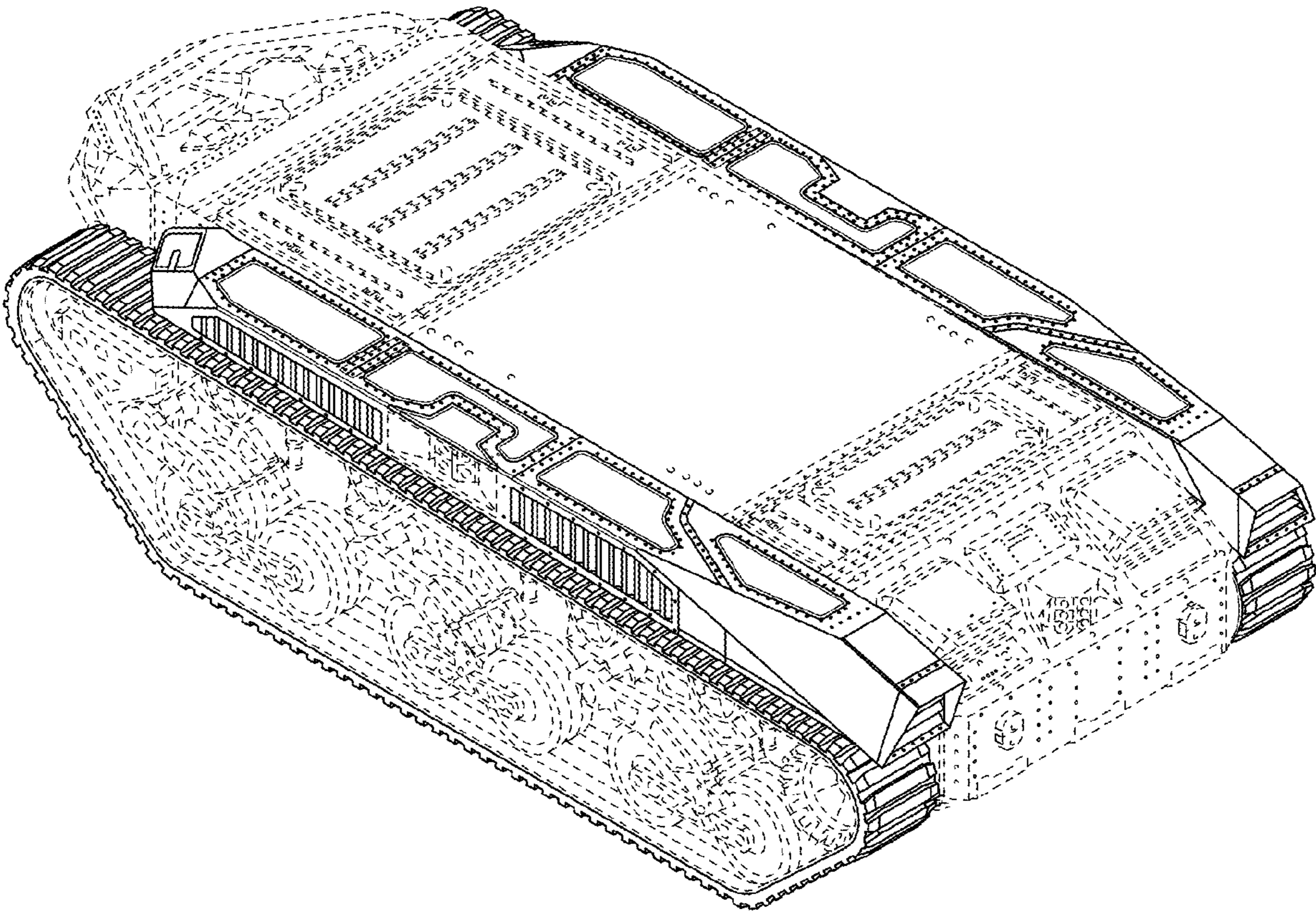

FIG. 6