



US00D923326S

(12) **United States Design Patent** (10) **Patent No.:** **US D923,326 S**
Yan (45) **Date of Patent:** **** Jun. 29, 2021**

(54) **VENTILATED TWO-SIDED PET CARRIER BACKPACK**

(71) Applicant: **Nelson Yan**, Los Angeles, CA (US)

(72) Inventor: **Nelson Yan**, Los Angeles, CA (US)

(**) Term: **15 Years**

(21) Appl. No.: **29/671,315**

(22) Filed: **Nov. 26, 2018**

(51) **LOC (13) Cl.** **03-01**

(52) **U.S. Cl.**
USPC **D3/217**

(58) **Field of Classification Search**
USPC D3/215, 216, 217, 231, 315, 900, 222,
D3/272, 273, 294, 903, 289
CPC A45F 3/02; A45F 3/04
See application file for complete search history.

(56) **References Cited**

U.S. PATENT DOCUMENTS

6,286,461	B1	9/2001	Martz	
D487,189	S	3/2004	Ukitsu	
6,899,057	B1	5/2005	Chrisco et al.	
D523,995	S	6/2006	Knittle	
D575,461	S *	8/2008	Cannon	D3/273
D662,263	S	6/2012	Chau et al.	
8,413,808	B1	4/2013	Tong	
D685,952	S	7/2013	Dixon	
D717,502	S	11/2014	Dixon	
D724,792	S	3/2015	Renforth et al.	
D734,032	S	7/2015	Robinson et al.	
D734,942	S *	7/2015	Robinson	D3/217
9,392,766	B1	7/2016	Elden	
D804,738	S	12/2017	Nourollah	
D818,204	S	5/2018	Renforth	
D856,602	S	8/2019	Lu	
D856,662	S	8/2019	Breines	
D869,099	S	12/2019	Lu	
D872,945	S	1/2020	Lu	

D883,658	S *	5/2020	Lu	D3/217
D883,659	S *	5/2020	Lu	D3/217
D885,043	S *	5/2020	Lu	D3/217
2002/0139820	A1	10/2002	Godshaw et al.	
2008/0216760	A1	9/2008	Cannon et al.	
2010/0000472	A1	1/2010	Siklosi	
2010/0108730	A1	5/2010	Sabbah	
2011/0005467	A1	1/2011	Siklosi	
2012/0186533	A1	7/2012	Lu	
2014/0166704	A1	6/2014	Perera	
2016/0192614	A1	7/2016	Hawk et al.	

(Continued)

OTHER PUBLICATIONS

Amazon, "PetAmi Deluxe Pet Carrier Backpack for Small Cats and Dogs, Puppies . . . ", First review posted Mar. 16, 2018. (<https://www.amazon.com/dp/B07B66PWS7/>) (Year: 2018).*

(Continued)

Primary Examiner — April Rivas

(74) *Attorney, Agent, or Firm* — Cislo & Thomas, LLP

(57) **CLAIM**

The ornamental design for a ventilated two-sided pet carrier backpack, as shown and described.

DESCRIPTION

FIG. 1 is front perspective view of the ventilated two-sided pet carrier backpack, showing my new design; FIG. 2 is a rear perspective view thereof; FIG. 3 is a front elevation view thereof; FIG. 4 is a rear elevation view thereof; FIG. 5 is a left side elevation view thereof; FIG. 6 is a right side elevation view thereof; FIG. 7 is a top plan view thereof; and, FIG. 8 is a bottom plan view thereof. The broken lines are for environmental purposes only and form no part the claimed design.

1 Claim, 8 Drawing Sheets

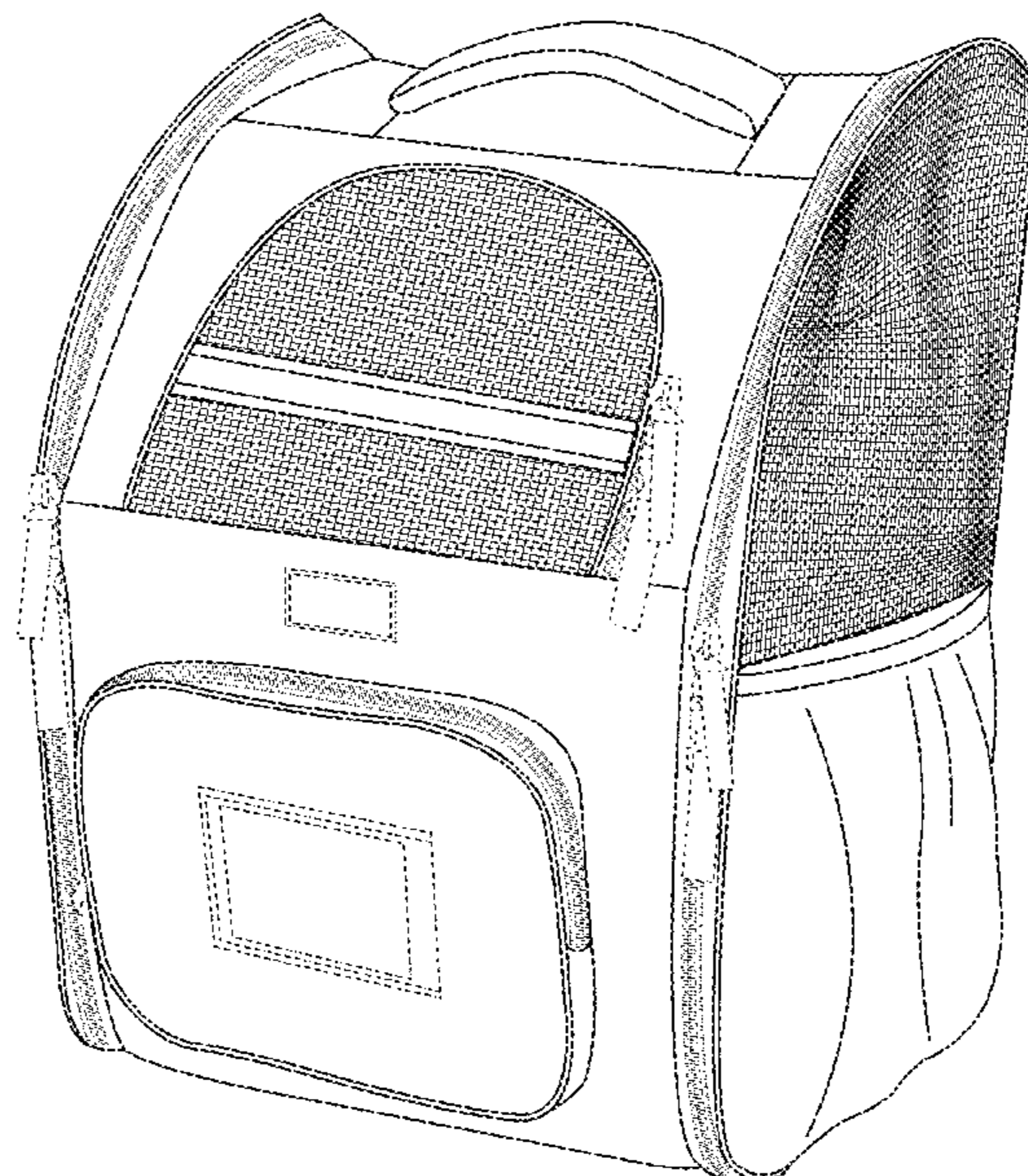

(56)

References Cited

U.S. PATENT DOCUMENTS

2017/0112267 A1 4/2017 Wu
2019/0133073 A1* 5/2019 Lu A45C 11/00

OTHER PUBLICATIONS

Amazon.com _ PetAmi Premium Airline Approved Soft-Sided Pet Travel Carrier _ Ventilated, Comfortable Design with Safety Features _ Ideal for Small to Medium Sized Cats, Dogs, and Pets (Large, Heather Gray) _ Pet Supplies (<https://www.amazon.com/PetAmi-Approved-Soft-Sided-Ventilated-Comfortable/dp/B07D3J5ZVQ>); 10 pages.

Amazon.com _ Prodigen Pet Carrier Airline Approved Pet Carrier Dog Carriers for Small Dogs, Cat Carriers for Medium Cats Small Cats, Small Pet Carrier Small Dog Carrier Airline Approved Cat Pet Travel Carrier-Gray _ Pet Supplies(https://www.amazon.com/Prodigen-Carrier-Airline-Approved-Travel/dp/B07GB62JD4/ref=sr_1_2?dchild=1&keywords=prodigen+pet+carrier&qid=1588...); 9 pages.

Amazon.com _ PetAmi Pet Carrier Backpack for Small Cats, Dogs, Puppies _ Airline Approved _ Ventilated, 4 Way Entry, Safety and Soft Cushion Back Support _ Collapsible for Travel, Hiking, Outdoor (Turquoise) _ Pet Supplies (https://www.amazon.com/PetAmi-Ventilated-Structured-Collapsible-Turquoise/dp/B07P9ZQ18V/ref=pd_sbs_199_8?encoding=UTF8&pd_rd_i=B07P9ZQ18V&pd_rd_r=df2c3b05-2926-43fb-9b01); 10 pages.

Outmax Dog Backpack Carrier with Mesh for Small Dog Cat Puppies, Cat Bag for Pets Under 18 Pounds (Dark Grey)_ Amazon.in _ Pet Supplies(<https://www.amazon.in/Outmax-Backpack-Carrier-Puppies-Pounds/dp/B07ZCSKZDK>); 3 pages.

* cited by examiner



Fig. 1

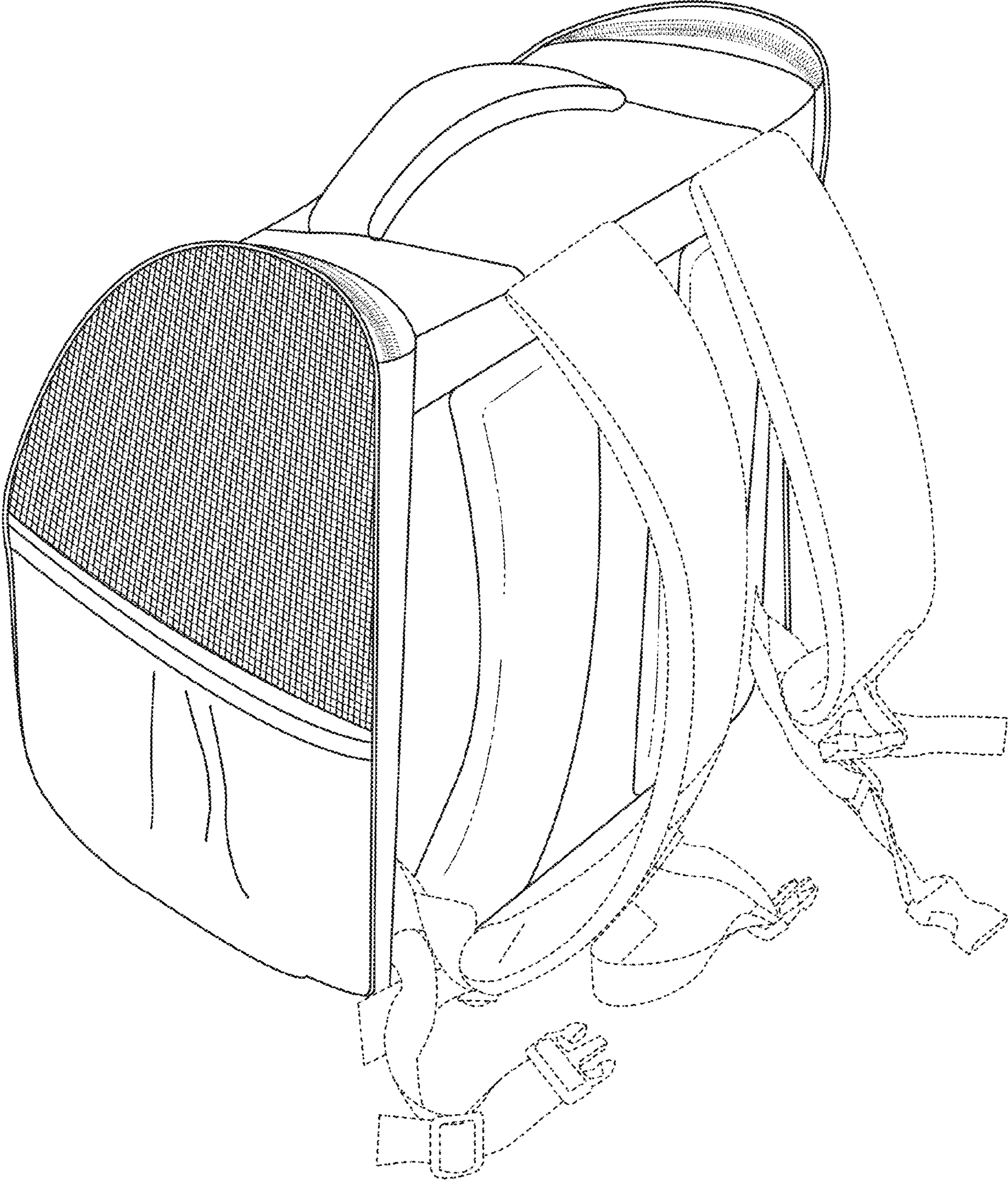

Fig. 2

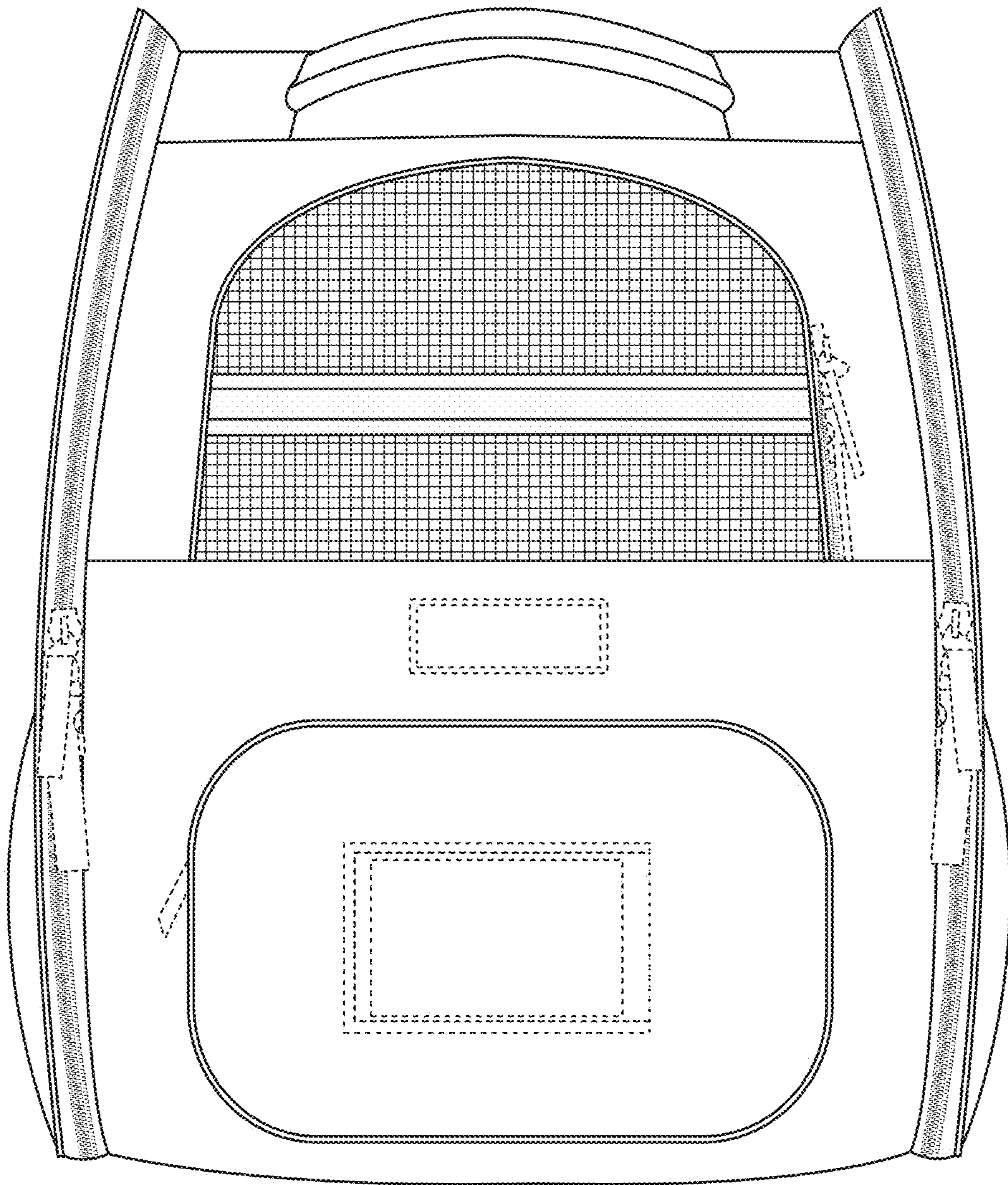

Fig. 3

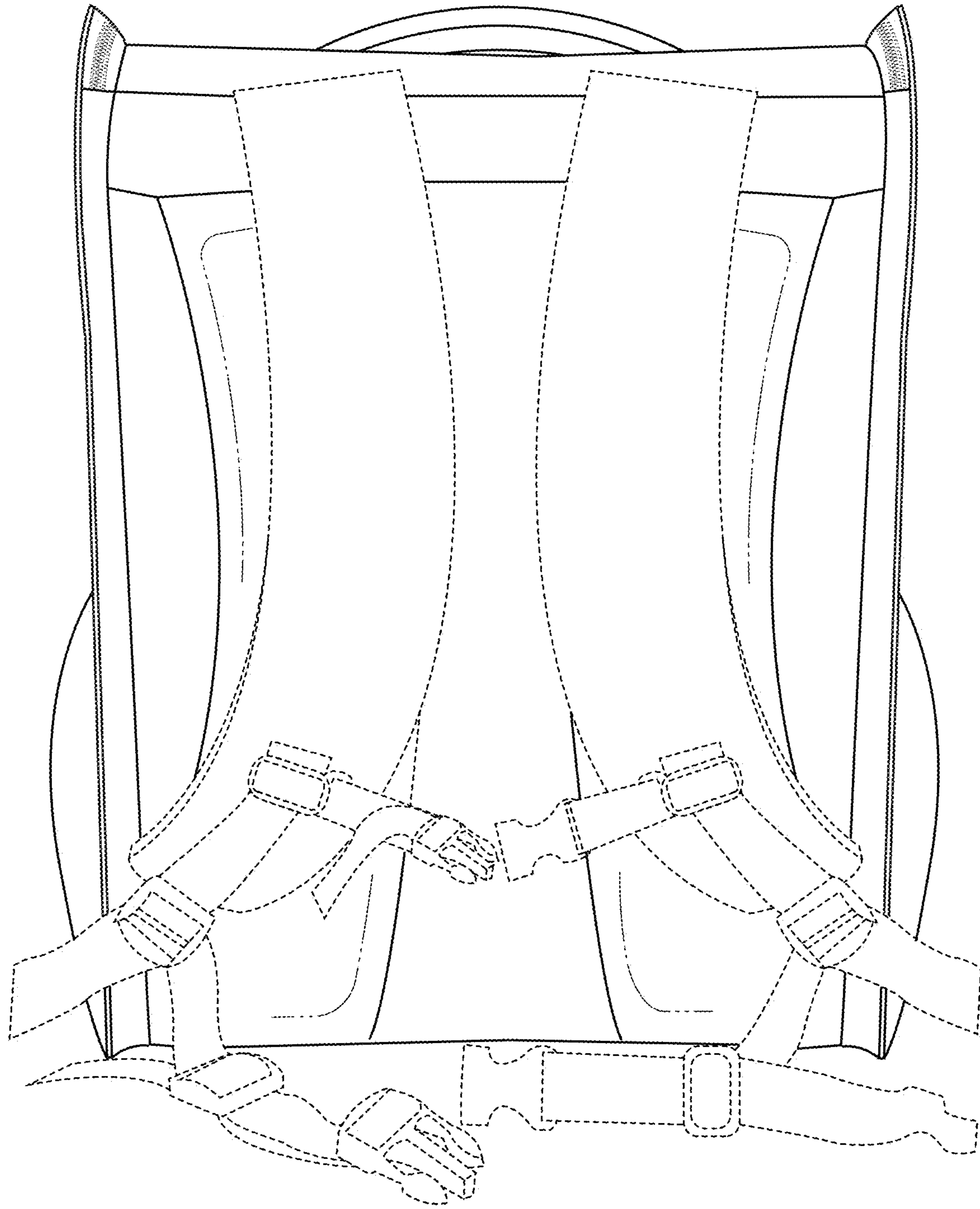

Fig. 4

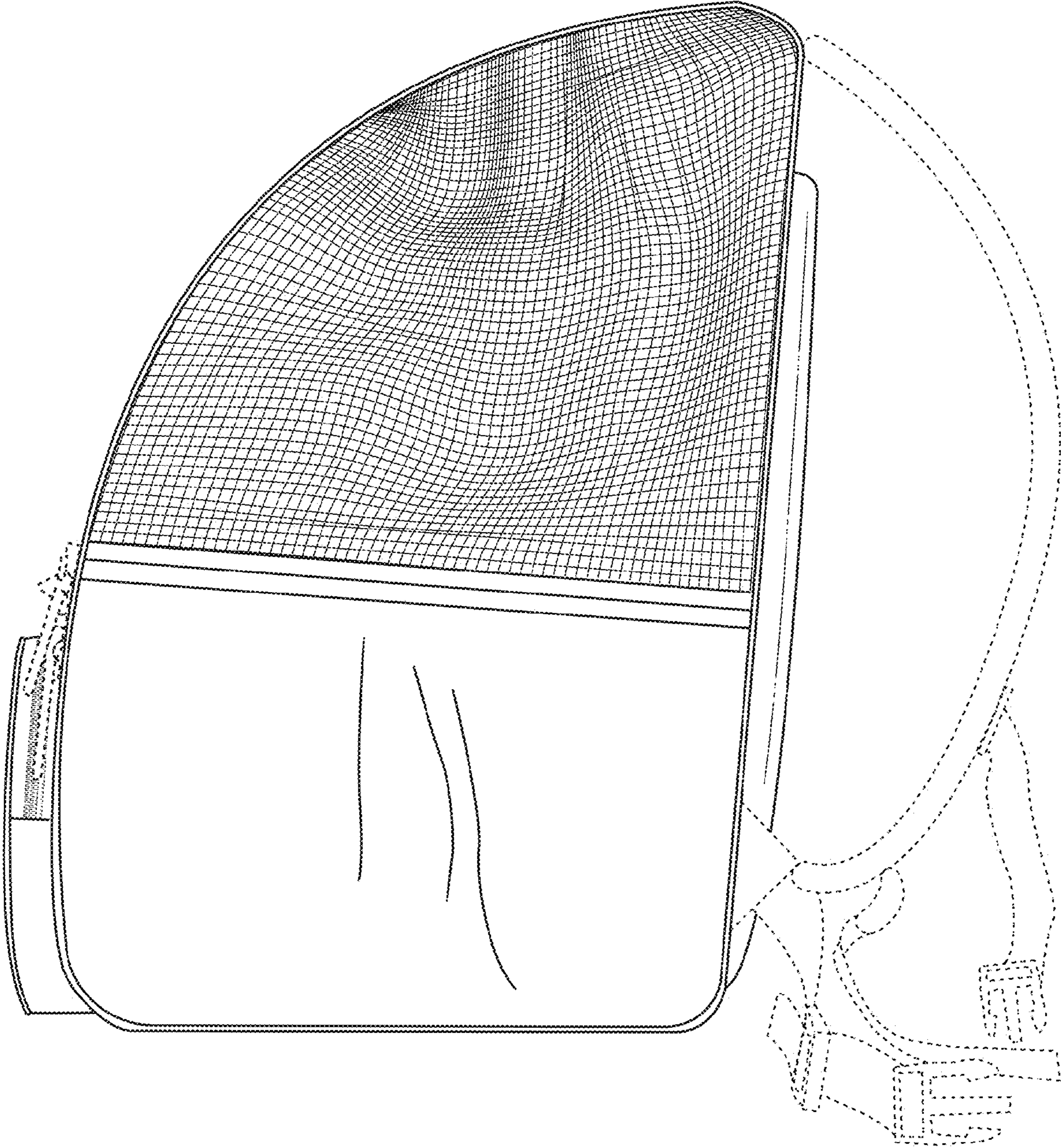

Fig. 5

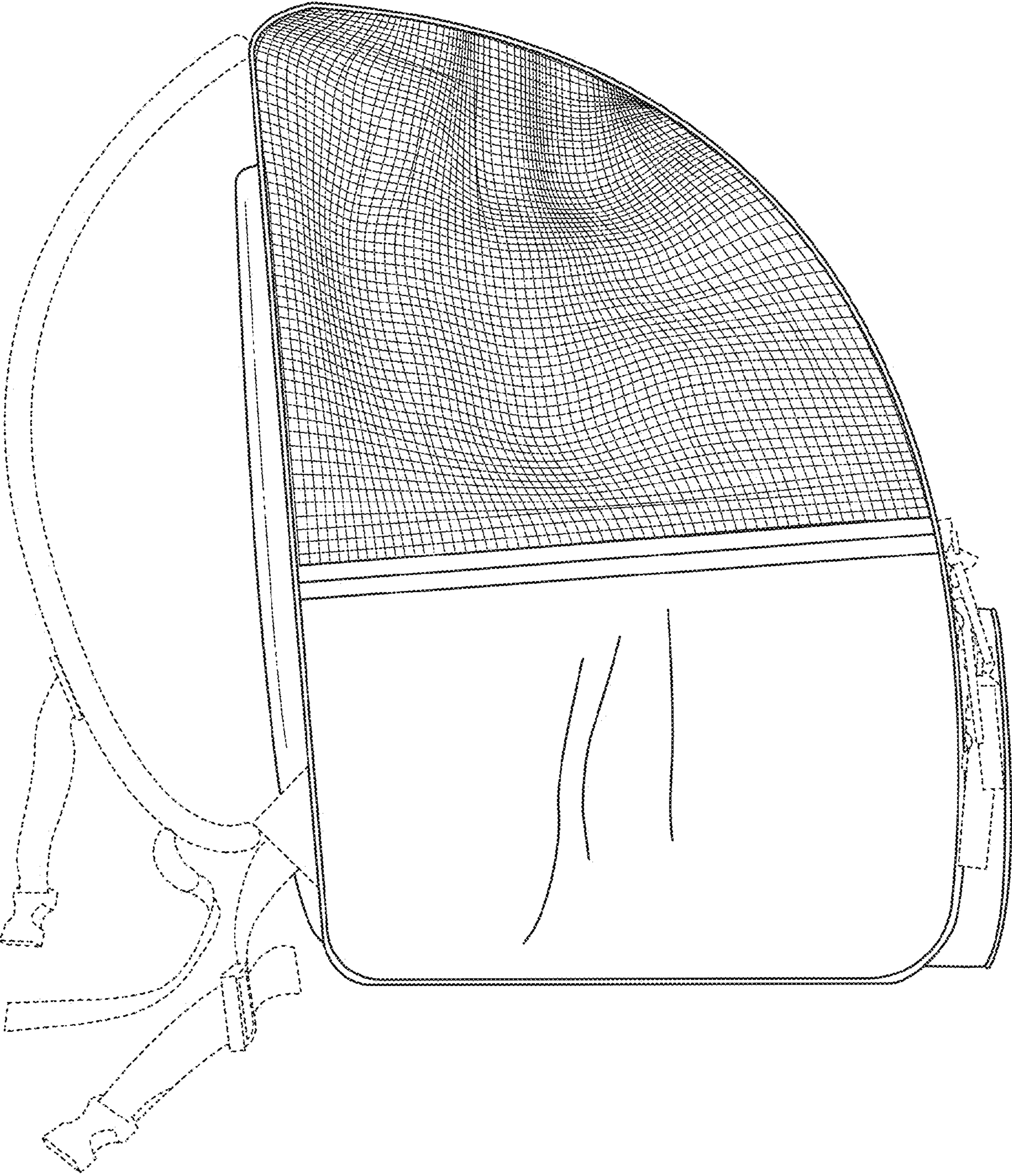

Fig. 6

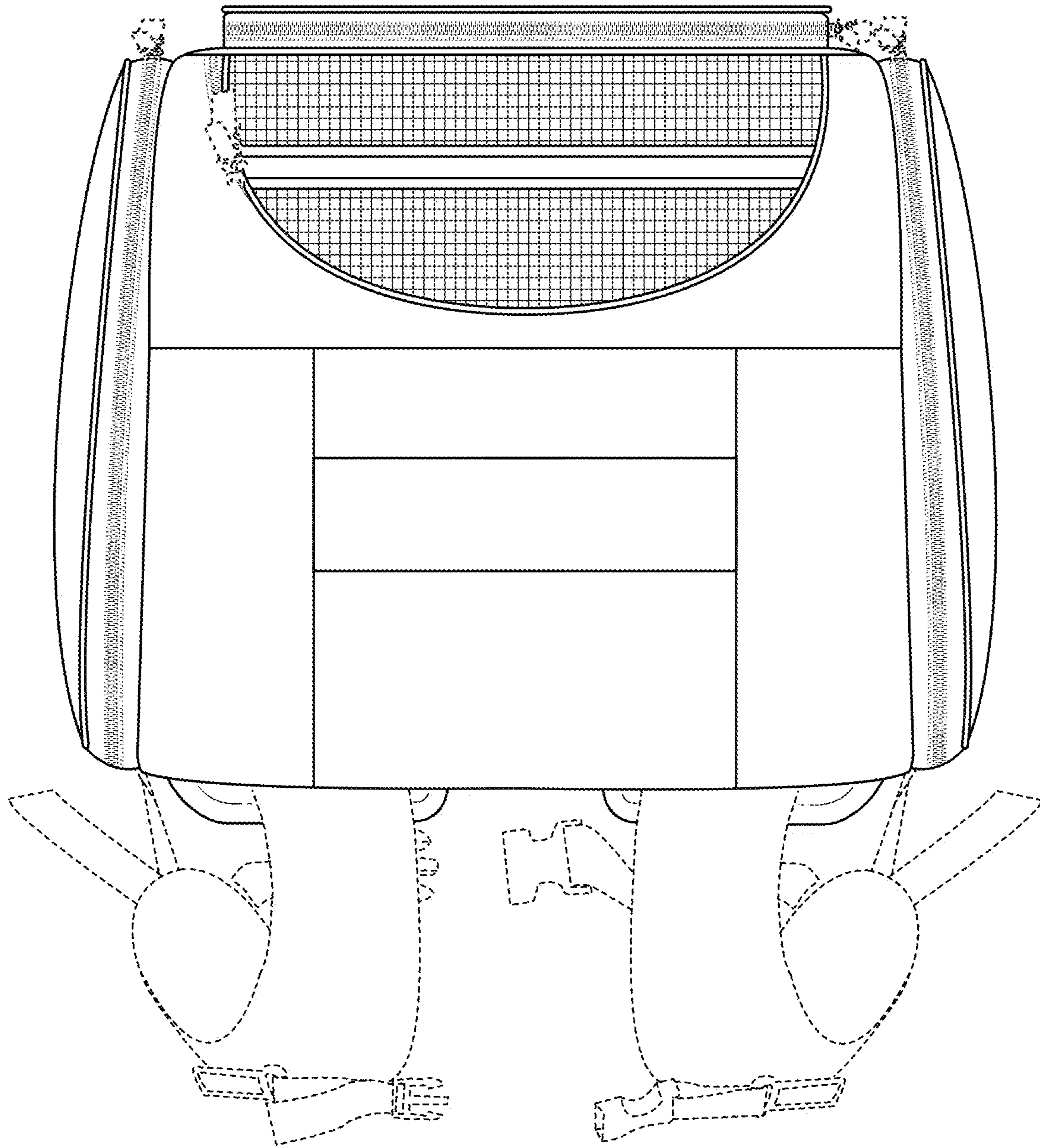

Fig. 7

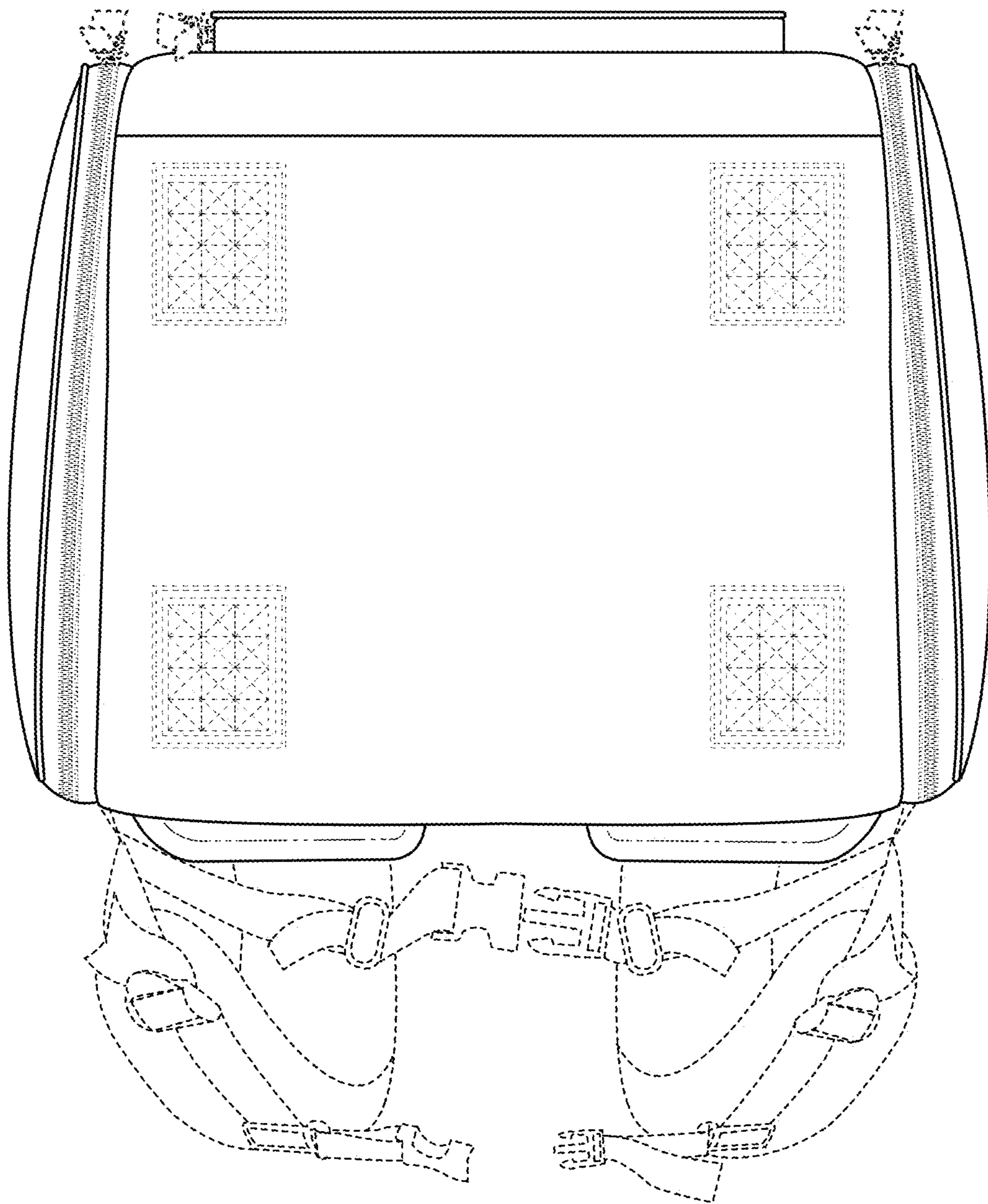

Fig. 8