



US00D923321S

(12) **United States Design Patent**
Milne

(10) **Patent No.:** **US D923,321 S**
(45) **Date of Patent:** **** Jun. 29, 2021**

- (54) **BOOT WEIGHT**
- (71) Applicant: **TADANYC, LLC**, New York, NY (US)
- (72) Inventor: **Tara Milne**, New York, NY (US)
- (73) Assignee: **TADANYC, LLC.**, New York, NY (US)
- (**) Term: **15 Years**

| | | | | | |
|-----------|------|---------|----------|-------|-------------|
| 6,769,807 | B2 * | 8/2004 | Bayard | | A45C 13/004 |
| | | | | | 150/106 |
| 7,108,425 | B2 * | 9/2006 | Temkin | | A45C 13/002 |
| | | | | | 150/106 |
| 8,251,113 | B2 * | 8/2012 | Baxter | | A45C 1/024 |
| | | | | | 150/104 |
| D730,038 | S * | 5/2015 | Ghahari | | D2/979 |
| 9,226,557 | B2 * | 1/2016 | Sullivan | | A45C 3/06 |
| 9,265,315 | B1 * | 2/2016 | Frid | | A45C 1/02 |
| D809,773 | S * | 2/2018 | Hollaus | | D2/979 |
| D869,839 | S * | 12/2019 | Hollaus | | D2/979 |

- (21) Appl. No.: **29/686,807**
- (22) Filed: **Apr. 8, 2019**
- (51) **LOC (13) Cl.** **07-99**
- (52) **U.S. Cl.**
USPC **D2/979**
- (58) **Field of Classification Search**
USPC D2/896, 897, 898, 909, 910, 911, 912,
D2/946, 961, 970, 742, 743, 980, 981,
D2/983, 979; 12/114.2, 114.6, 114.8,
12/115.2, 115.6, 115.8, 116.6, 117.4, 123,
12/123.5, 124, 128 R; 36/43, 44, 83, 88,
36/93; 223/112, 113, 118, 120
CPC A43B 1/0036; A43B 21/00; A43B 21/06;
A43B 9/14; A43B 1/0045; A43B 13/10;
A43B 23/06; A43B 23/07; A43B 5/12;
A43B 23/081; A43B 7/147; A43B 19/00;
A43D 3/1491; A43D 3/1433
See application file for complete search history.

(56) **References Cited**

U.S. PATENT DOCUMENTS

| | | | | | |
|-----------|------|--------|--------|-------|-------------|
| D158,356 | S * | 5/1950 | Conney | | D9/455 |
| 3,200,427 | A * | 8/1965 | Daley | | A43D 3/1408 |
| | | | | | 12/128 R |
| D389,649 | S * | 1/1998 | Miller | | D3/318 |
| 6,179,025 | B1 * | 1/2001 | Sutton | | A45C 3/08 |
| | | | | | 150/105 |

OTHER PUBLICATIONS

Flower Girl Basket posted by Twenty Eight 12 posted review date Sep. 21, 2016, © Etsy, [online], [site visited Sep. 24, 2020]. Available from Internet, <https://www.etsy.com/listing/292319069/flower-girl-basket-sequin-with-satin> (Year: 2016).*

(Continued)

Primary Examiner — Cynthia Ramirez

Assistant Examiner — Laura H Yu

(74) *Attorney, Agent, or Firm* — Dennemeyer & Associates, LLC

(57) **CLAIM**

I claim the ornamental design for a boot weight, as shown and described.

DESCRIPTION

FIG. 1 is a perspective view of the boot weight; FIG. 2 is a front side elevational view of the boot weight; FIG. 3 is a rear side elevational view of the boot weight; FIG. 4 is a right side elevational view of the boot weight; FIG. 5 is a left side elevational view of the boot weight; FIG. 6 is a top plan view of the boot weight; and, FIG. 7 is a bottom plan view of the boot weight. The dashed lines in the figures represent stitching and form part of the claimed design.

1 Claim, 5 Drawing Sheets

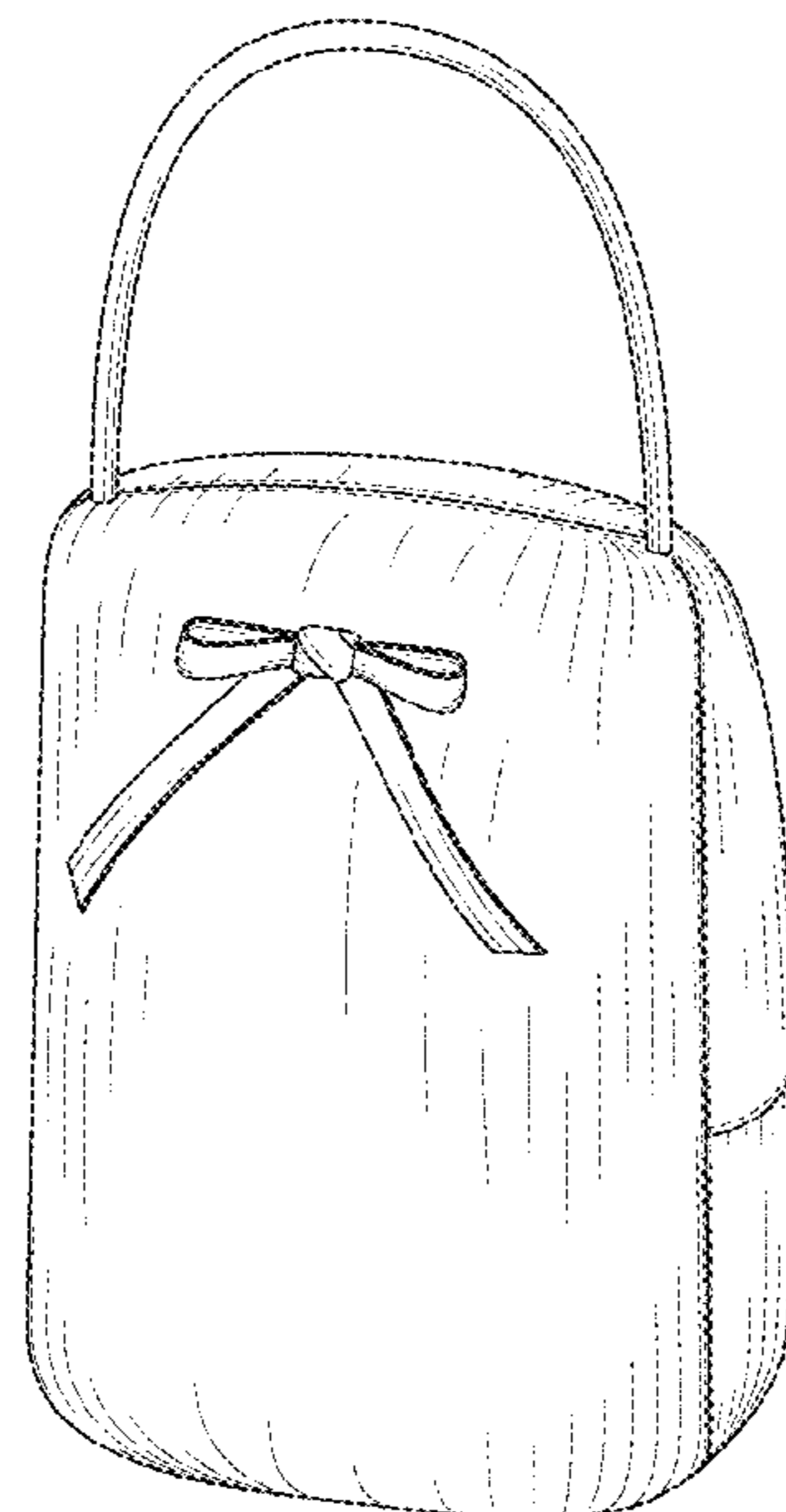

(56)

References Cited

OTHER PUBLICATIONS

Luxury Boot Stuffers posted by Fabriniq2 posted review date
Mar. 26, 2018, © Etsy, [online], [site visited Sep. 24, 2020].
Available from Internet, [https://www.etsy.com/listing/577640523/
luxury-boot-stuffers-free-shipping](https://www.etsy.com/listing/577640523/luxury-boot-stuffers-free-shipping) (Year: 2018).*

* cited by examiner

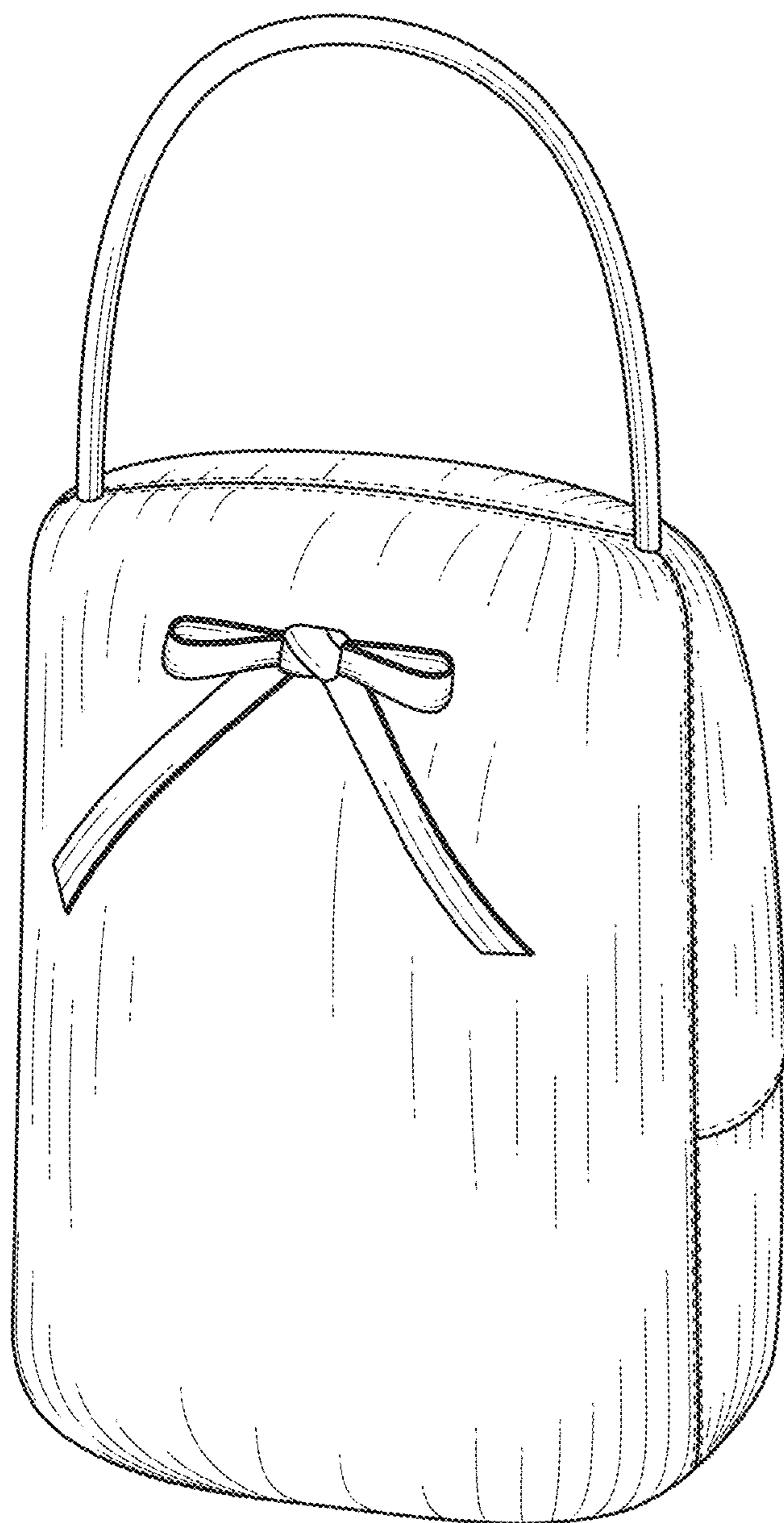

FIG. 1

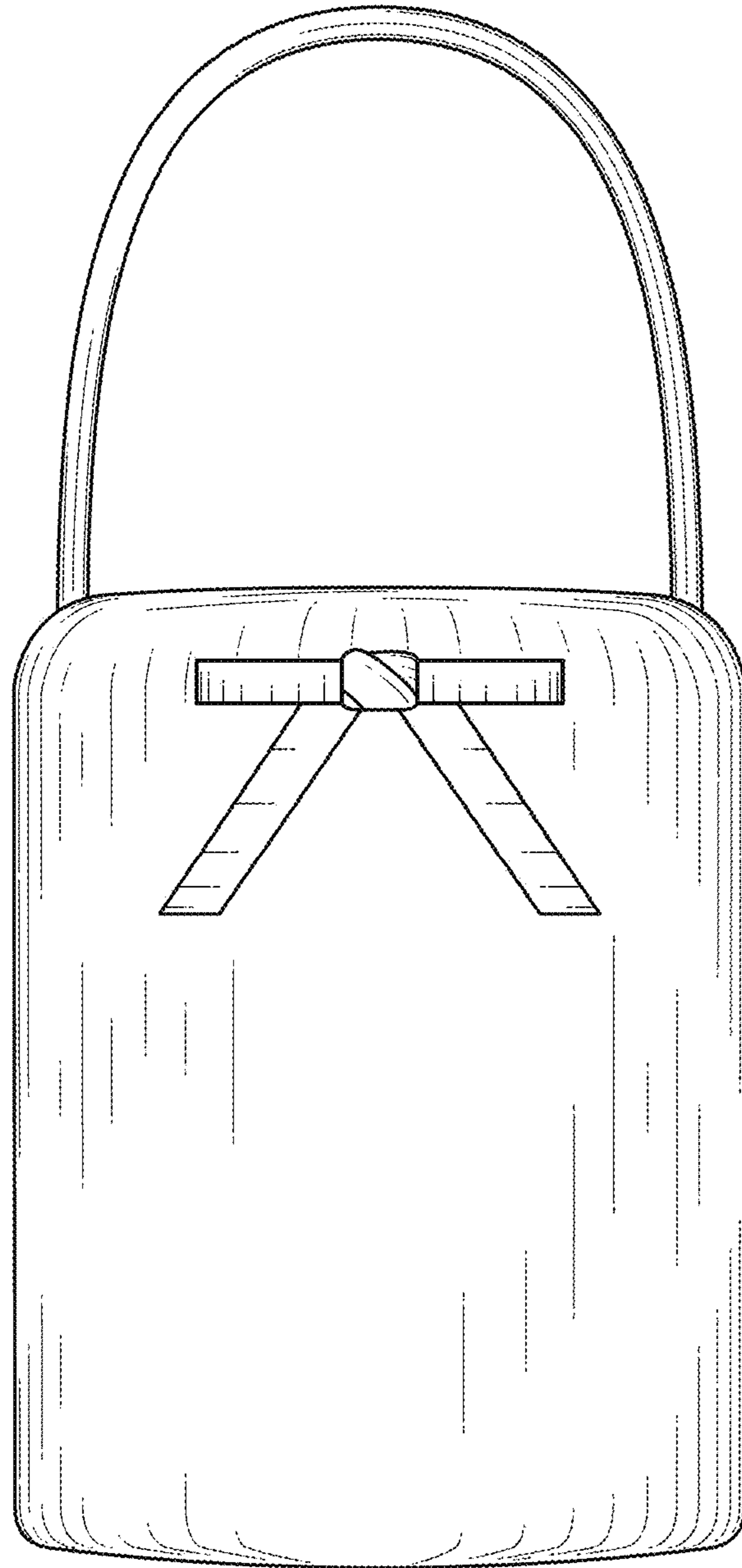

FIG. 2

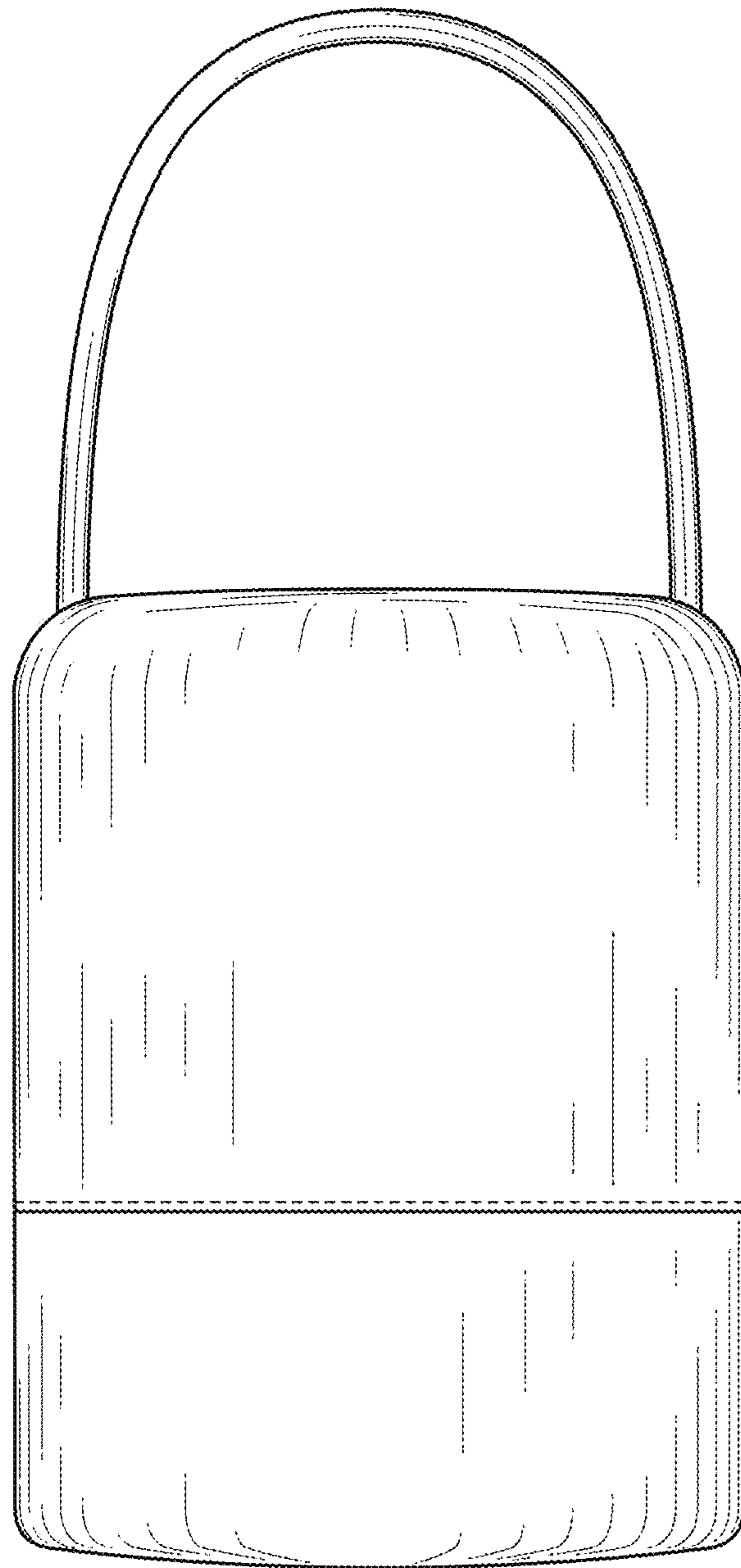

FIG. 3

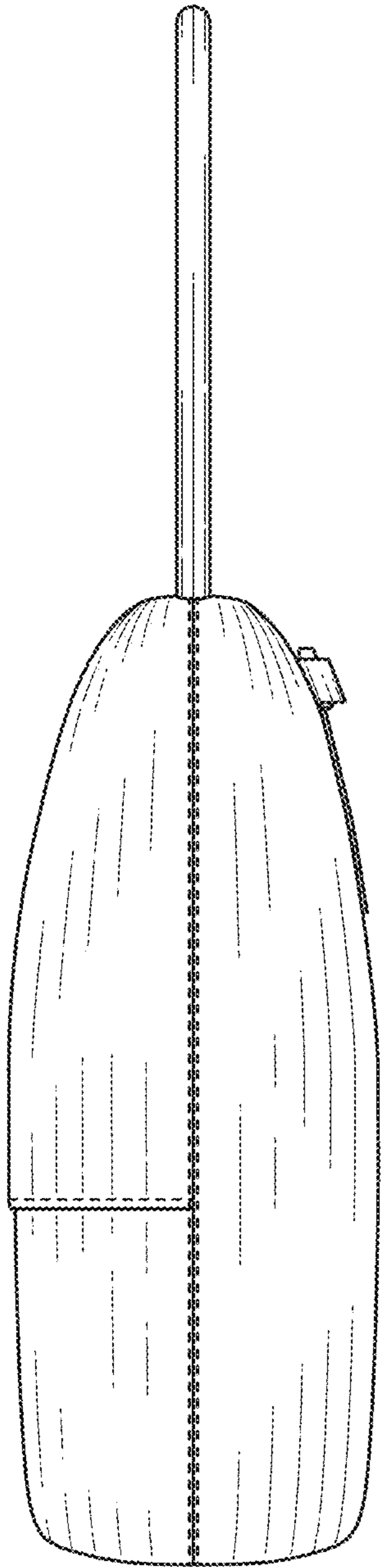

FIG. 4

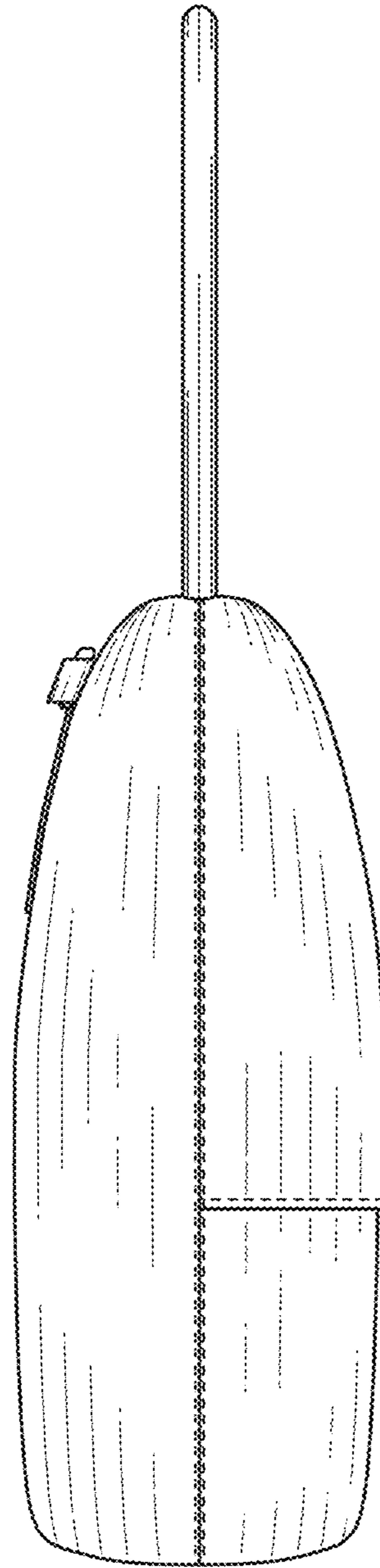

FIG. 5

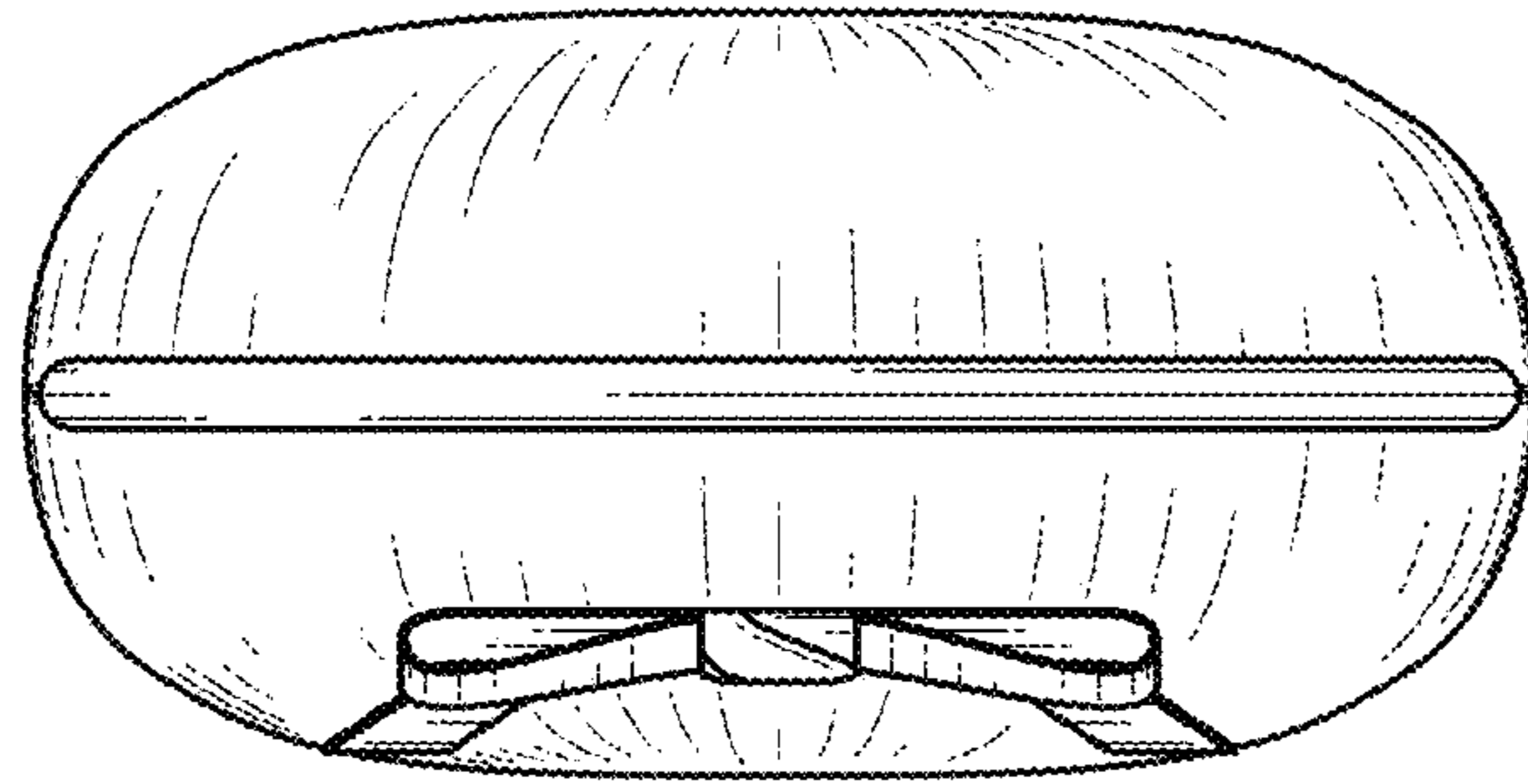

FIG. 6

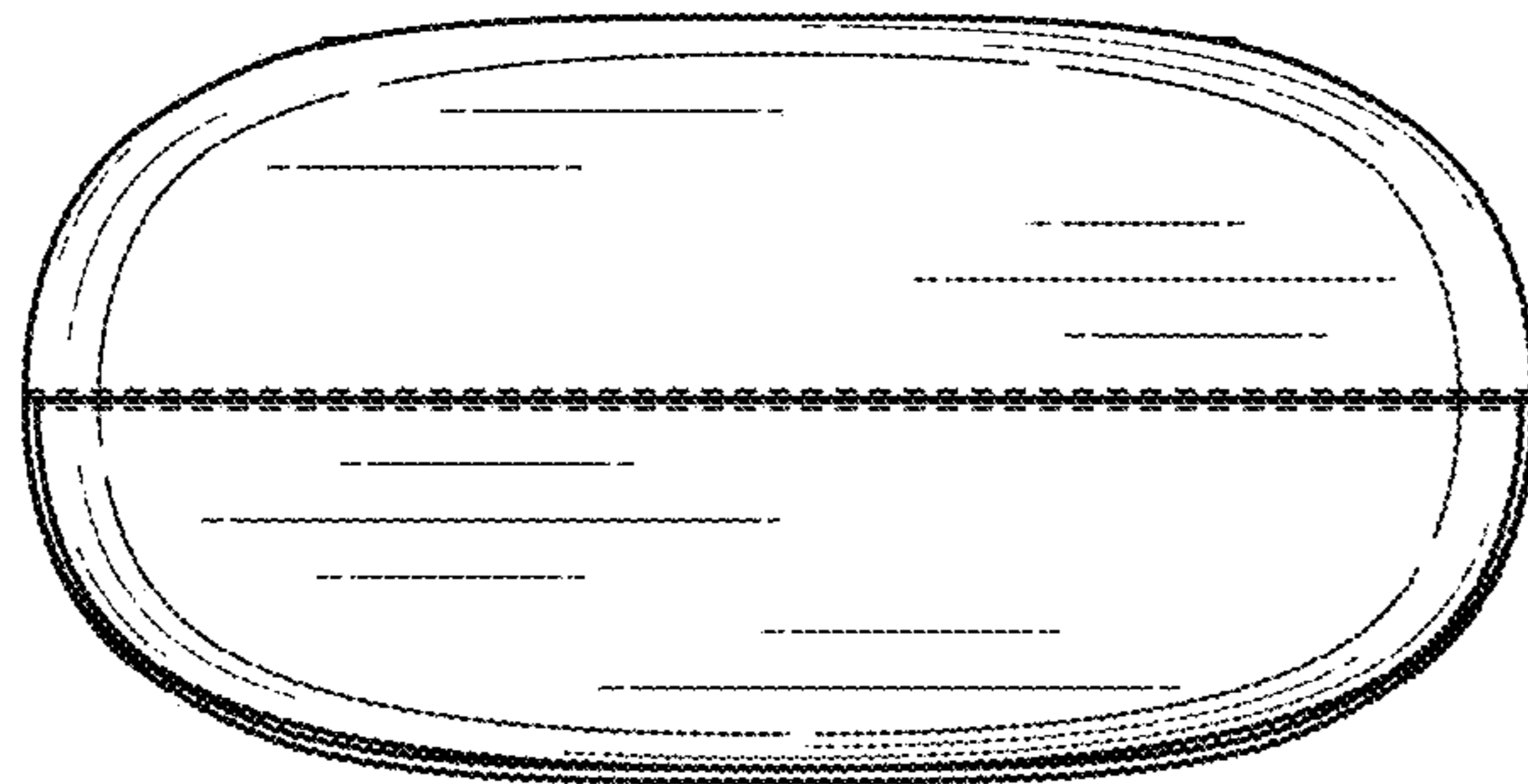

FIG. 7