



US00D923209S

(12) **United States Design Patent** (10) **Patent No.:** **US D923,209 S**  
**Zidarevich et al.** (45) **Date of Patent:** **\*\* Jun. 22, 2021**

(54) **JARRED CANDLE**

(71) Applicant: **TARGET BRANDS, INC.**,  
Minneapolis, MN (US)

(72) Inventors: **Carla Zidarevich**, Minneapolis, MN  
(US); **Stacy Lee Abel**, Champlin, MN  
(US)

(73) Assignee: **TARGET BRANDS, INC.**,  
Minneapolis, MN (US)

(\*\*) Term: **15 Years**

(21) Appl. No.: **29/681,754**

(22) Filed: **Feb. 27, 2019**

(51) **LOC (13) Cl.** ..... **26-01**

(52) **U.S. Cl.**  
USPC ..... **D26/22**

(58) **Field of Classification Search**  
USPC ..... D1/106, 107, 108, 109, 114, 115;  
D26/1-17, 19-24, 28-38, 40, 41, 43-45,  
(Continued)

(56) **References Cited**

**U.S. PATENT DOCUMENTS**

D18,685 S \* 10/1888 Atterbury ..... D9/635  
D194,944 S \* 4/1963 Frazier, Jr. .... D26/11  
(Continued)

**OTHER PUBLICATIONS**

Shop Your Way, "14oz Lidded Glass Jar Candle", first available Feb. 22, 2019. (<https://www.shopyourway.com/14oz-lidded-glass-jar-candle-lemon-zest-berry-fruit-collection-opalhouse-yellow/726547191>) (Year: 2019).\*

(Continued)

*Primary Examiner* — April Rivas  
*Assistant Examiner* — Justin A Johnson

(74) *Attorney, Agent, or Firm* — JoAnn M. Seaton;  
Griffiths & Seaton PLLC

(57) **CLAIM**

The ornamental design for a jarred candle, as shown and described.

**DESCRIPTION**

FIG. 1 is a top and front perspective view of a jarred candle, showing an embodiment of our new design;  
FIG. 2 is a front view thereof, the rear view being a mirror image of the front view;  
FIG. 3 is a right side view thereof, the left side view being a mirror image of the right side view;  
FIG. 4 is a top view thereof; and  
FIG. 5 is a bottom view thereof.  
FIG. 6 is a top and front perspective view of a jarred candle, showing an embodiment of our new design;  
FIG. 7 is a front view thereof, the rear view being a mirror image of the front view;  
FIG. 8 is a right side view thereof, the left side view being a mirror image of the right side view;  
FIG. 9 is a top view thereof; and  
FIG. 10 is a bottom view thereof.  
FIG. 11 is a top and front perspective view of a jarred candle, showing an embodiment of our new design;  
FIG. 12 is a front view thereof, the rear view being a mirror image of the front view;  
FIG. 13 is a right side view thereof, the left side view being a mirror image of the right side view;  
FIG. 14 is a top view thereof; and  
FIG. 15 is a bottom view thereof.  
FIG. 16 is a top and front perspective view of a jarred candle, showing an embodiment of our new design;  
FIG. 17 is a front view thereof, the rear view being a mirror image of the front view;  
FIG. 18 is a right side view thereof, the left side view being a mirror image of the right side view;  
FIG. 19 is a top view thereof; and  
FIG. 20 is a bottom view thereof.

In the drawings, the broken lines depict unclaimed subject matter only and form no part of the claimed design. The features shown in long dash-short dash bolded broken lines

(Continued)

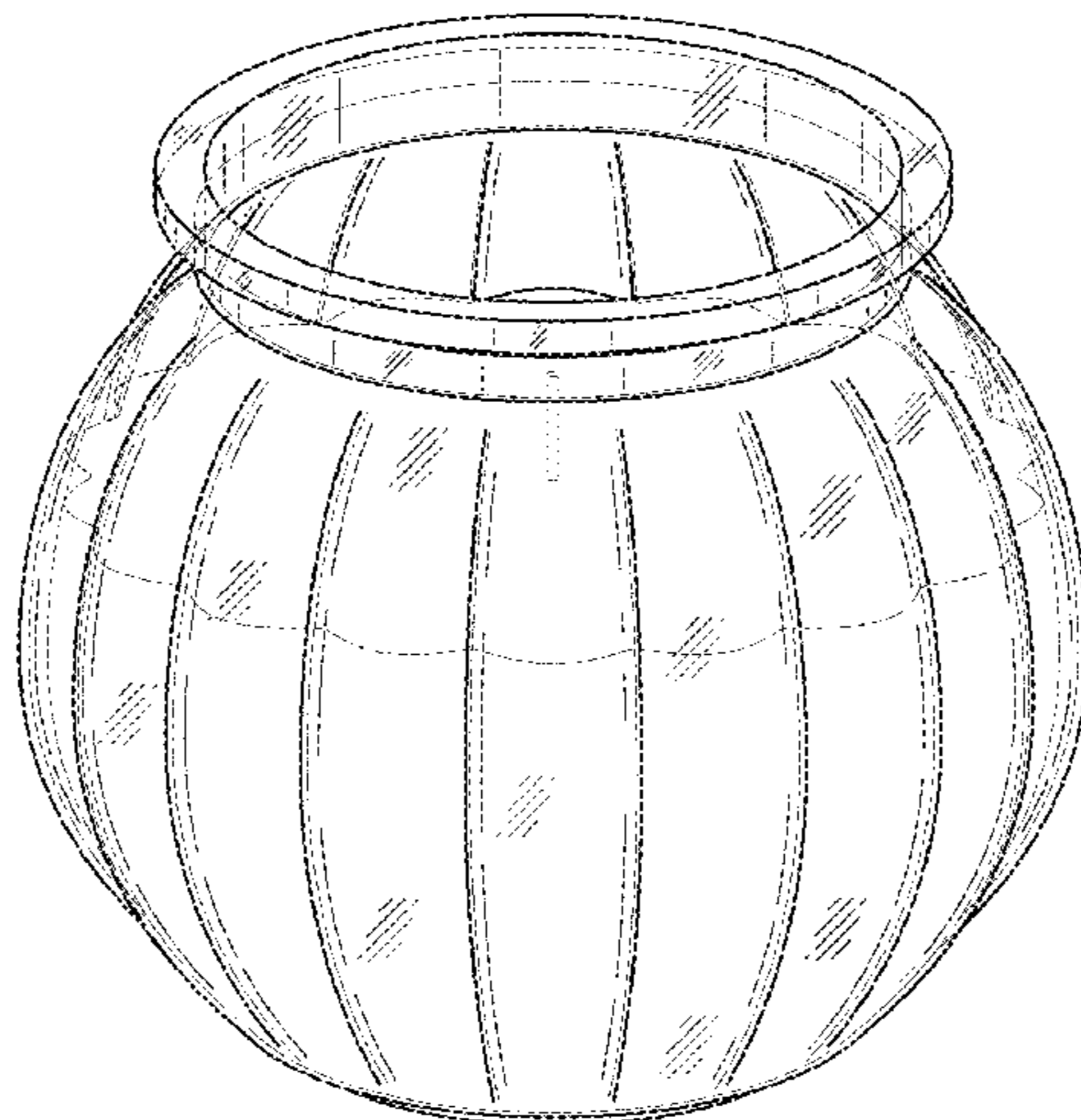

indicate the bounds of the claimed design and otherwise form no part of the claimed design.

**1 Claim, 20 Drawing Sheets**

**(58) Field of Classification Search**

USPC ..... D26/51, 55, 72, 74; D9/516, 517, 519, D9/549, 556, 557, 558, 574  
 CPC ..... F21H 1/00; F21H 1/02; F21H 1/04; F21H 5/00; F21H 7/00; F21L 2/00; F21L 19/00; F21L 19/003; F21L 19/006; F21S 2/00; F21S 2/005; F21S 6/00; F21S 6/001; F21S 9/00; F21S 9/02; F21S 43/00; F21V 15/00; F21V 35/00; F21V 35/003; F21V 35/006; F21V 37/0095; F21W 2103/00; F21W 2103/20; F21W 2121/00; F21W 2121/002; F21W 2121/04; H01K 5/00

See application file for complete search history.

**(56) References Cited**

U.S. PATENT DOCUMENTS

4,931,014	A *	6/1990	Scott .....	F21S 10/00 362/161
D397,460	S *	8/1998	Chambers .....	D11/143
D422,720	S *	4/2000	Hardy .....	D26/11
D463,046	S *	9/2002	Kumar .....	D26/11
D468,847	S *	1/2003	Lee .....	C11C 5/008 D26/9
D475,445	S *	6/2003	Kumar .....	F21S 10/00 D23/366
D572,145	S *	7/2008	Knapp .....	F21S 10/04 D9/548

D767,800	S *	9/2016	Moyal .....	D26/6
2008/0318177	A1 *	12/2008	Requejo .....	C11C 5/008 431/291
2010/0015561	A1 *	1/2010	McGuigan .....	F23D 3/16 431/291
2015/0176789	A1 *	6/2015	Garcia .....	F21S 10/04 362/157

OTHER PUBLICATIONS

At Home, “Maple Berry 7oz Pumpkin Shape Glass Candle”, first available Oct. 2020. (<https://www.athome.com/maple-berry-7oz-pumpkin-shape-glass-candle/124312310.html>) (Year: 2020).\*

Made-in-China, “330ml Halloween Gift Colored Glass Candle Holder”, first accessed Mar. 5, 2021. (<https://m.made-in-china.com/product/330ml-Halloween-Gift-Colored-Glass-Candle-Holder-with-Engraved-Pumpkin-741226455.html>) (Year: 2021).\*

Go For Green, “Olympia Pumpkin Jar Candle Clear”, first accessed Mar. 5, 2021. (<https://www.goforgreenuk.com/olympia-pumpkin-jar-candle-clear---case-12---cs750>) (Year: 2021).\*

“China 200ml Pumpkin Shape Glass Candle Jar Candle Holder”, printed from <https://xuzhouglass.en.made-in-china.com/product/dSlmHDzbXlkA/China-200ml-Pumpkin-Shape-Glass-Candle-Jar-Candle-Holder.html>, publicly available at least as early as Feb. 21, 2019 (10 pages).

“China 330ml Halloween Gift Colored Glass Candle Holder with Engraved Pumpkin”, printed from <https://xuzhouglass.en.made-in-china.com/product/ivfmUWYrsDkM/China-330ml-Halloween-Gift-Colored-Glass-Candle-Holder-with-Engraved-Pumpkin.html>, publicly available at least as early as Feb. 21, 2019 (9 pages).

“LEDMOMO Hanging Candle Holders”, printed from [www.amazon.com/LEDMOMO-Hanging-Holders-Tealight-Decoration/dp/B07FR8Y19T](http://www.amazon.com/LEDMOMO-Hanging-Holders-Tealight-Decoration/dp/B07FR8Y19T), publicly available at least as early as Feb. 21, 2019 (6 pages).

\* cited by examiner

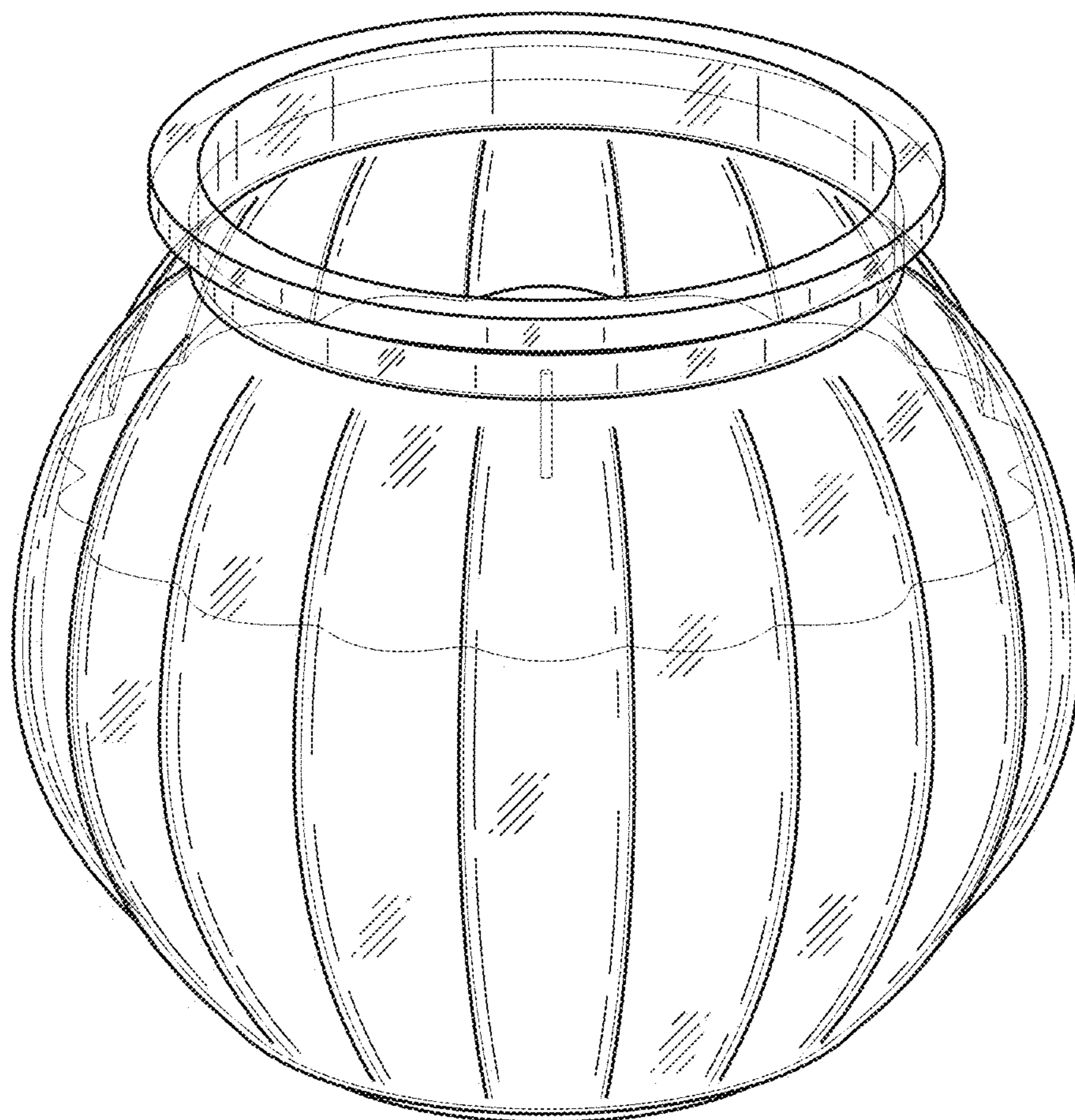

**FIG. 1**

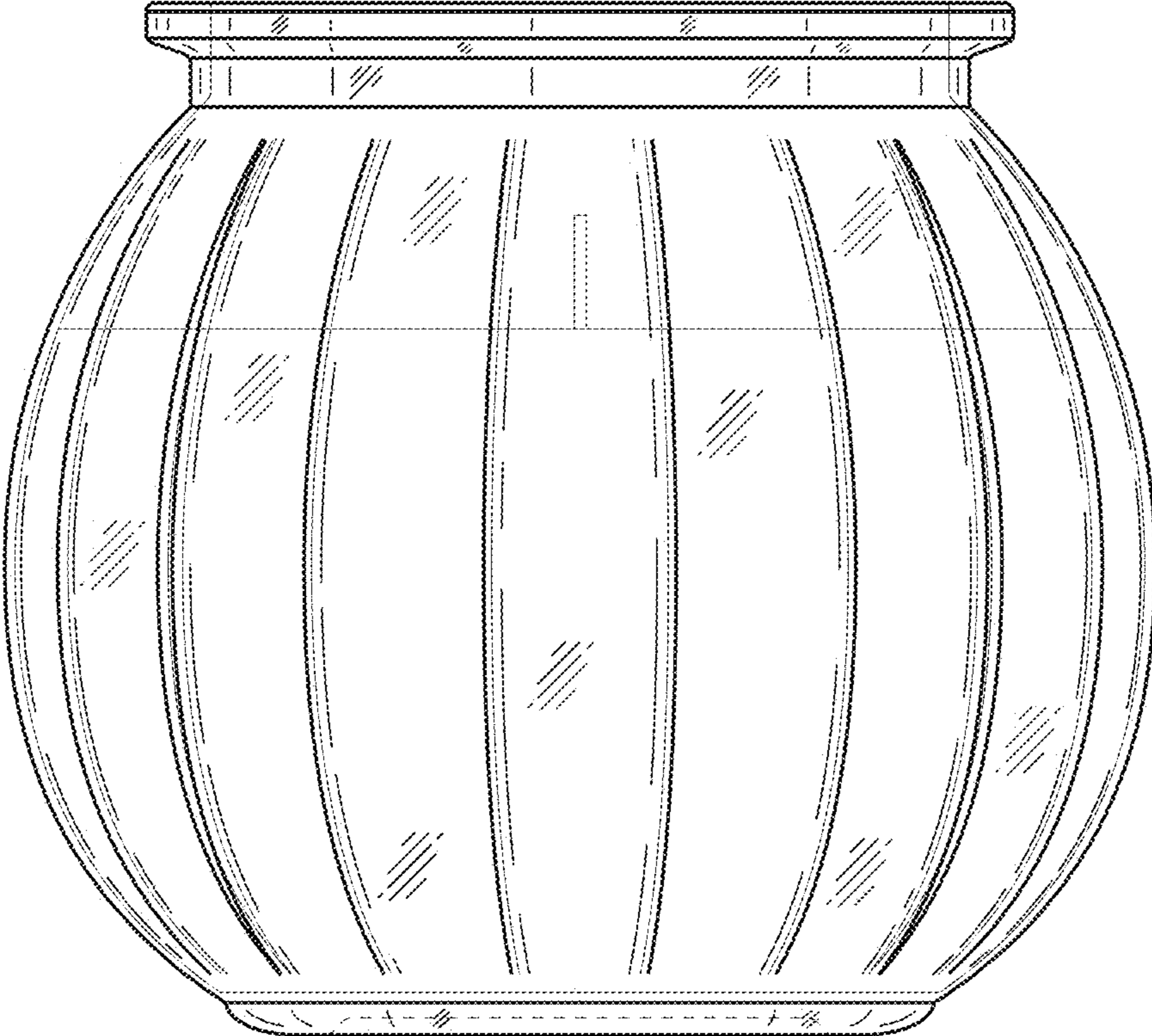
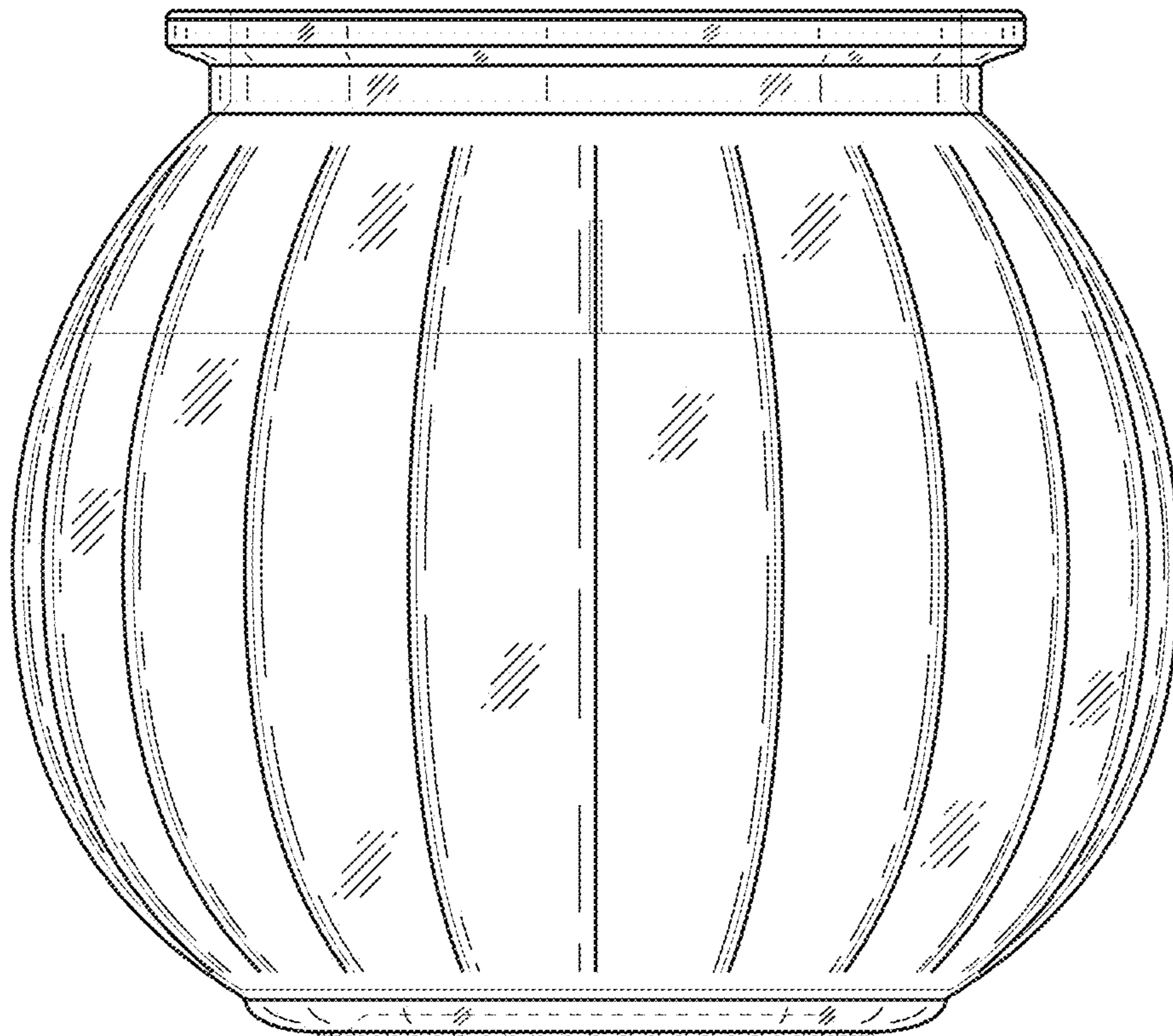

FIG. 2



**FIG. 3**

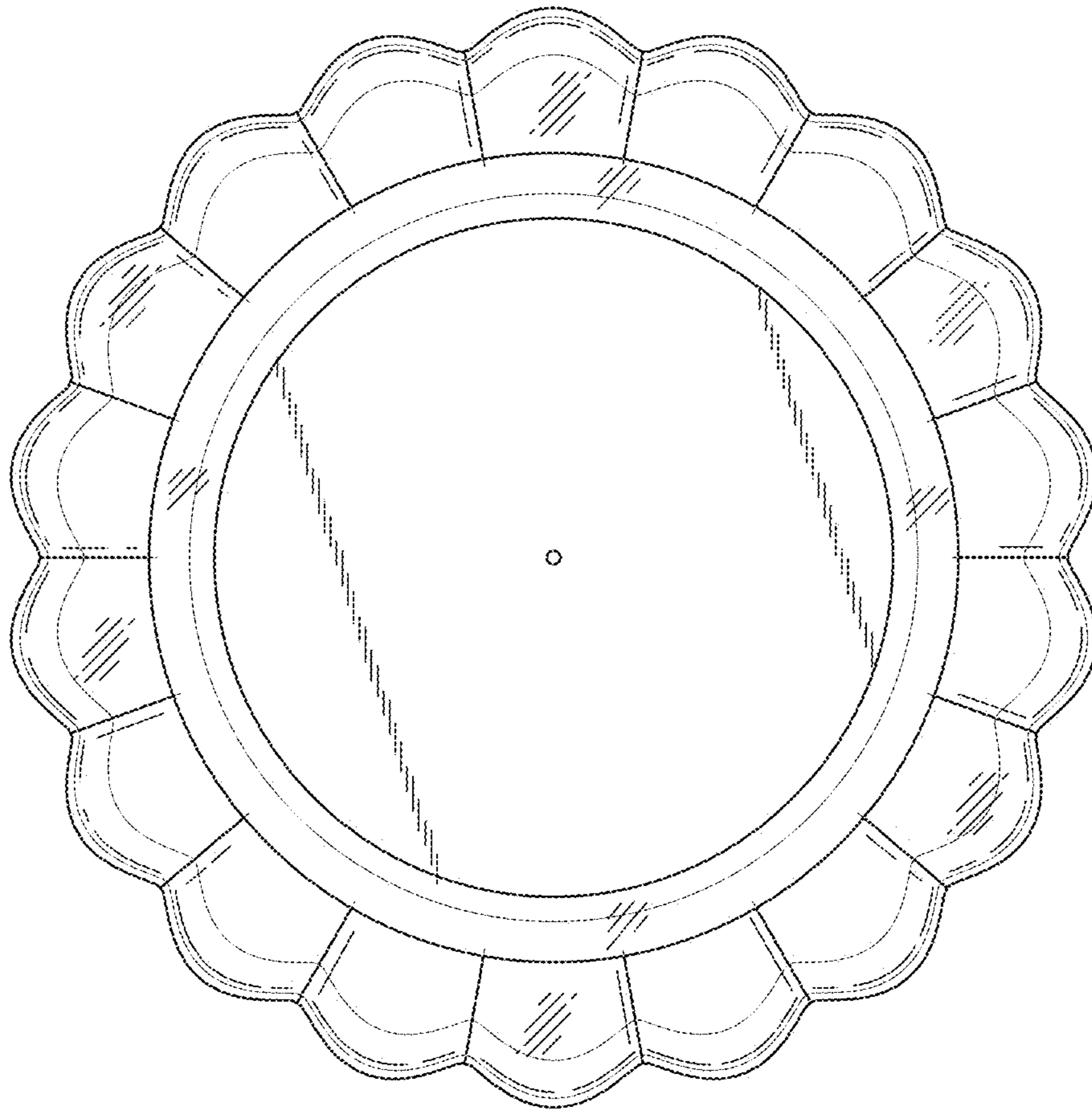

FIG. 4

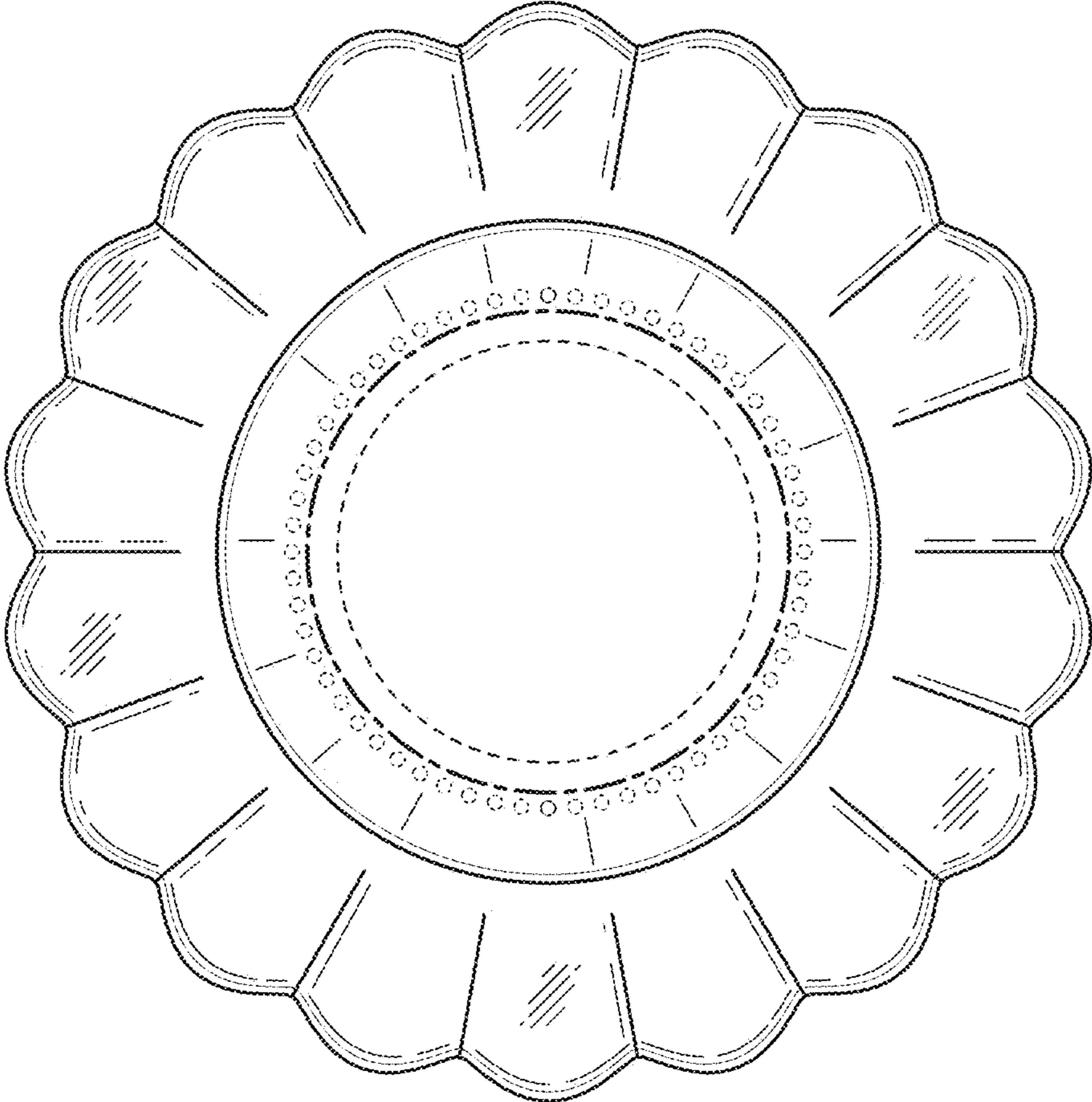
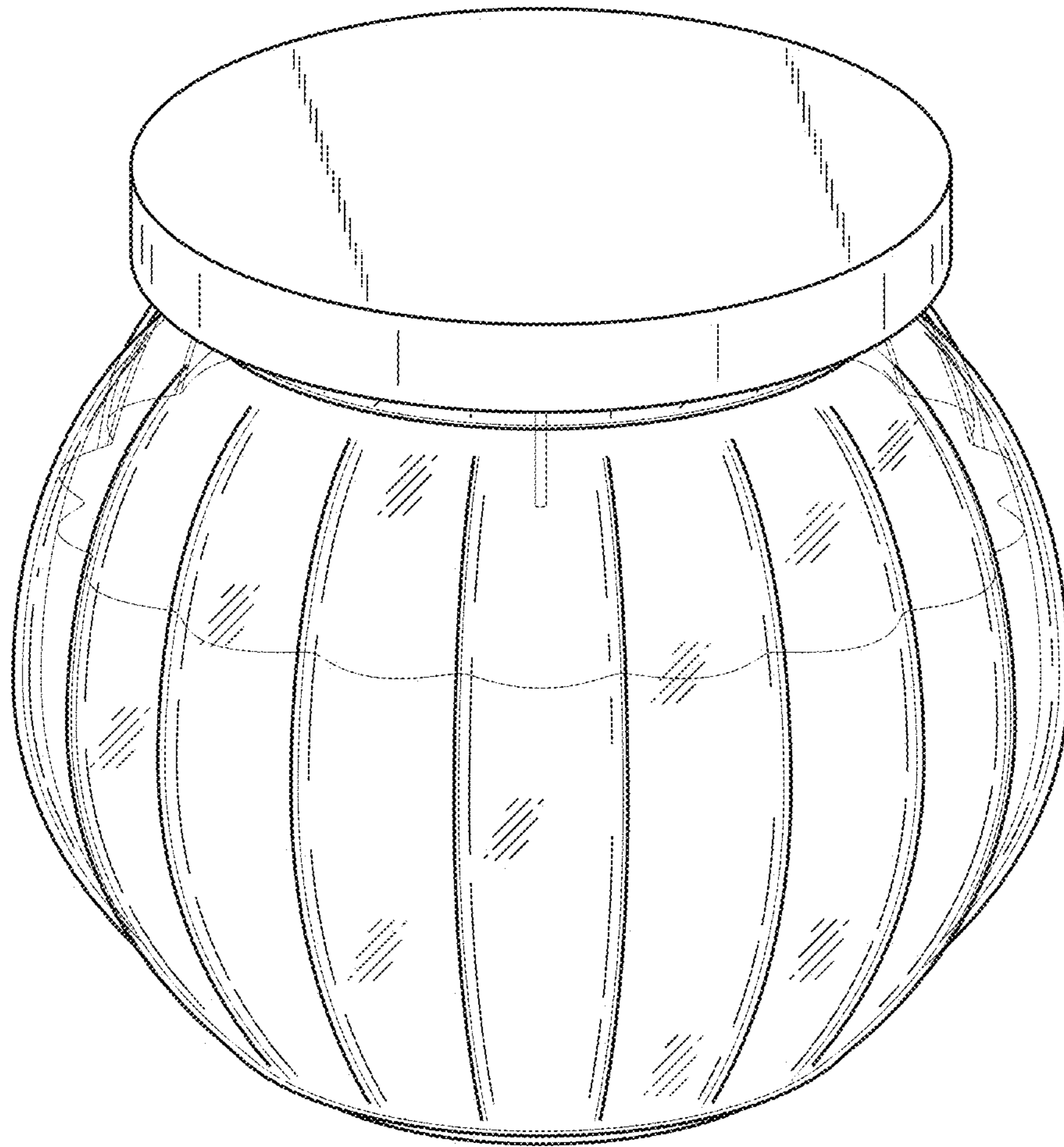
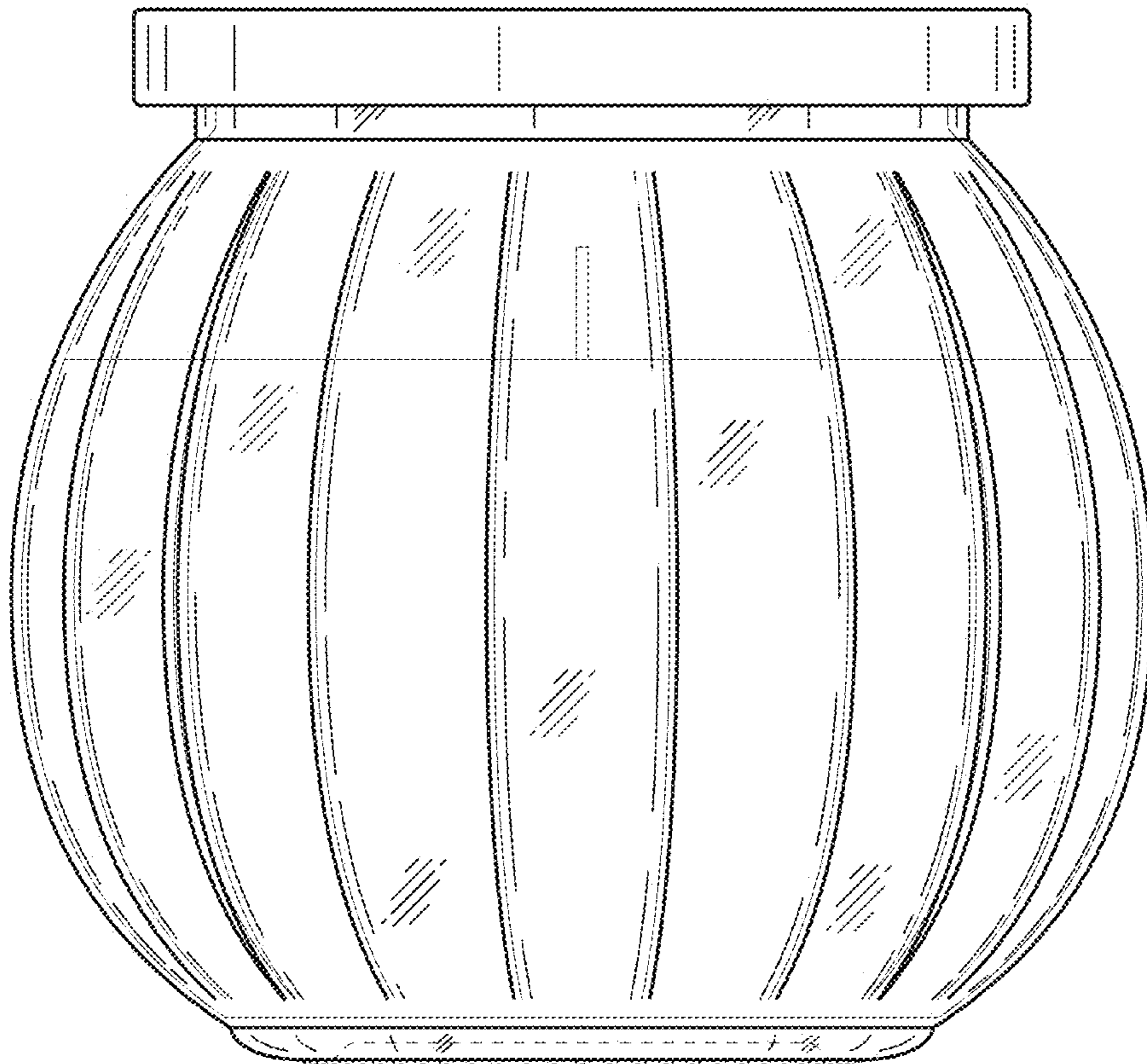

FIG. 5



**FIG. 6**





**FIG. 7**

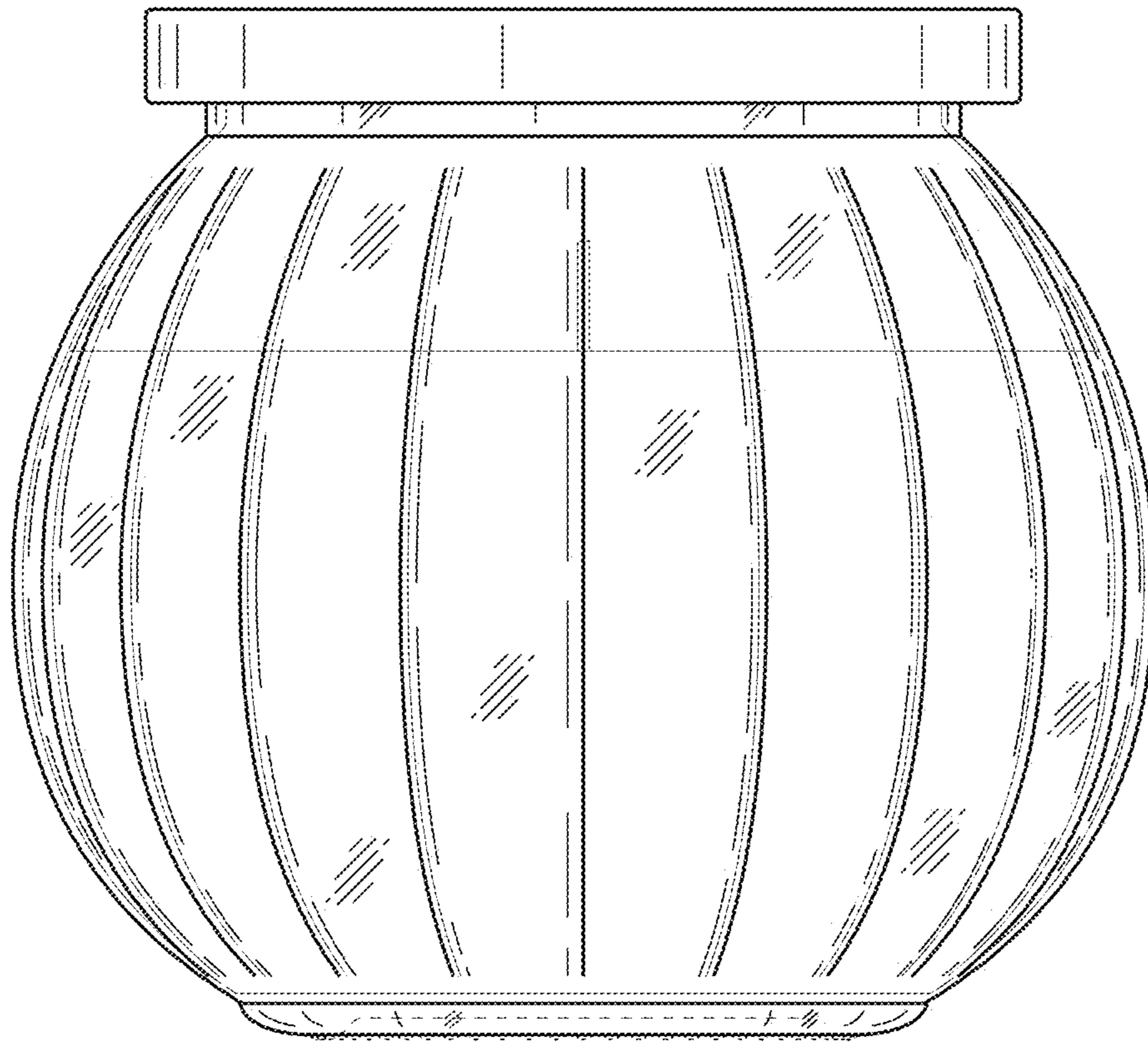
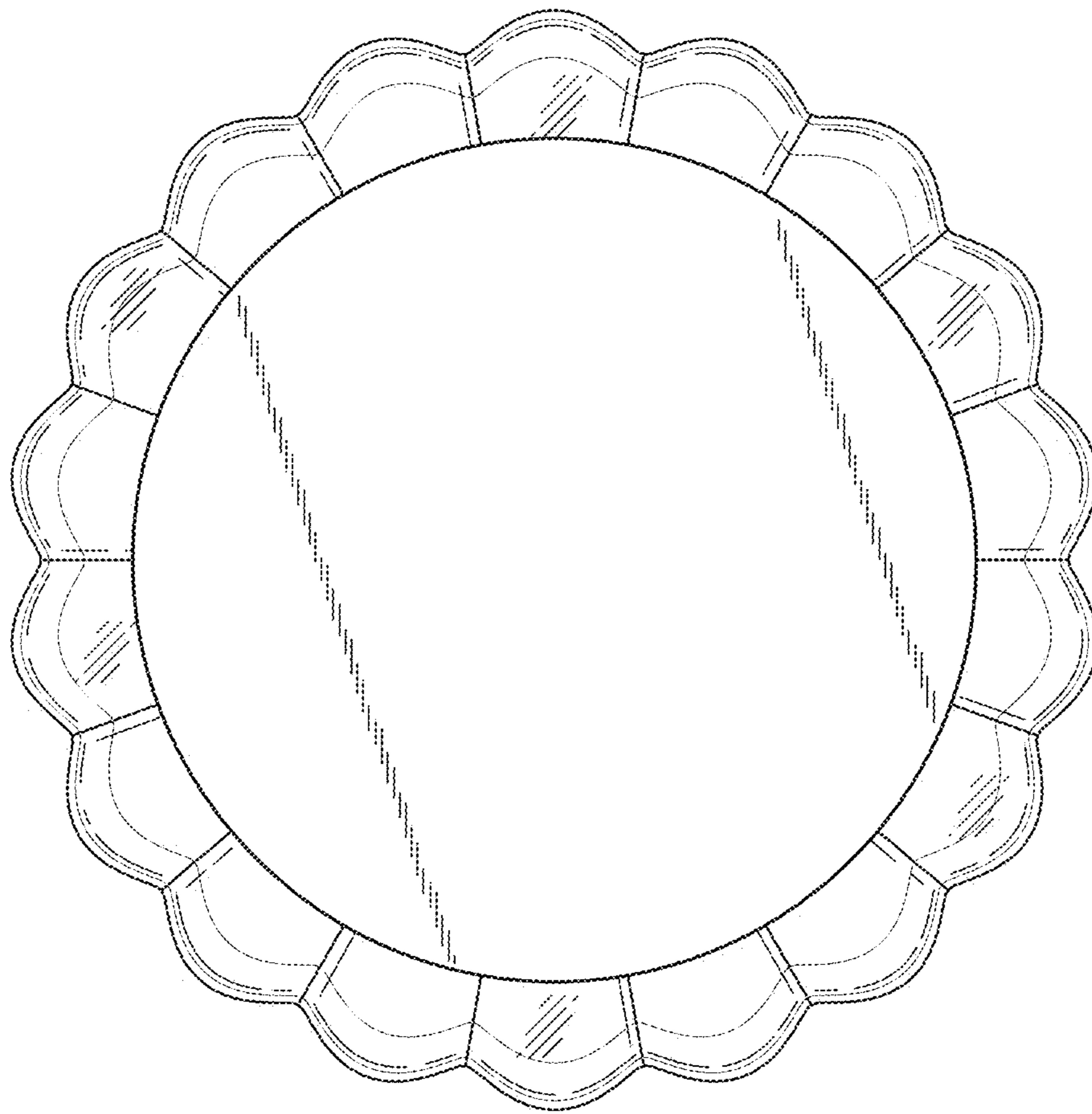
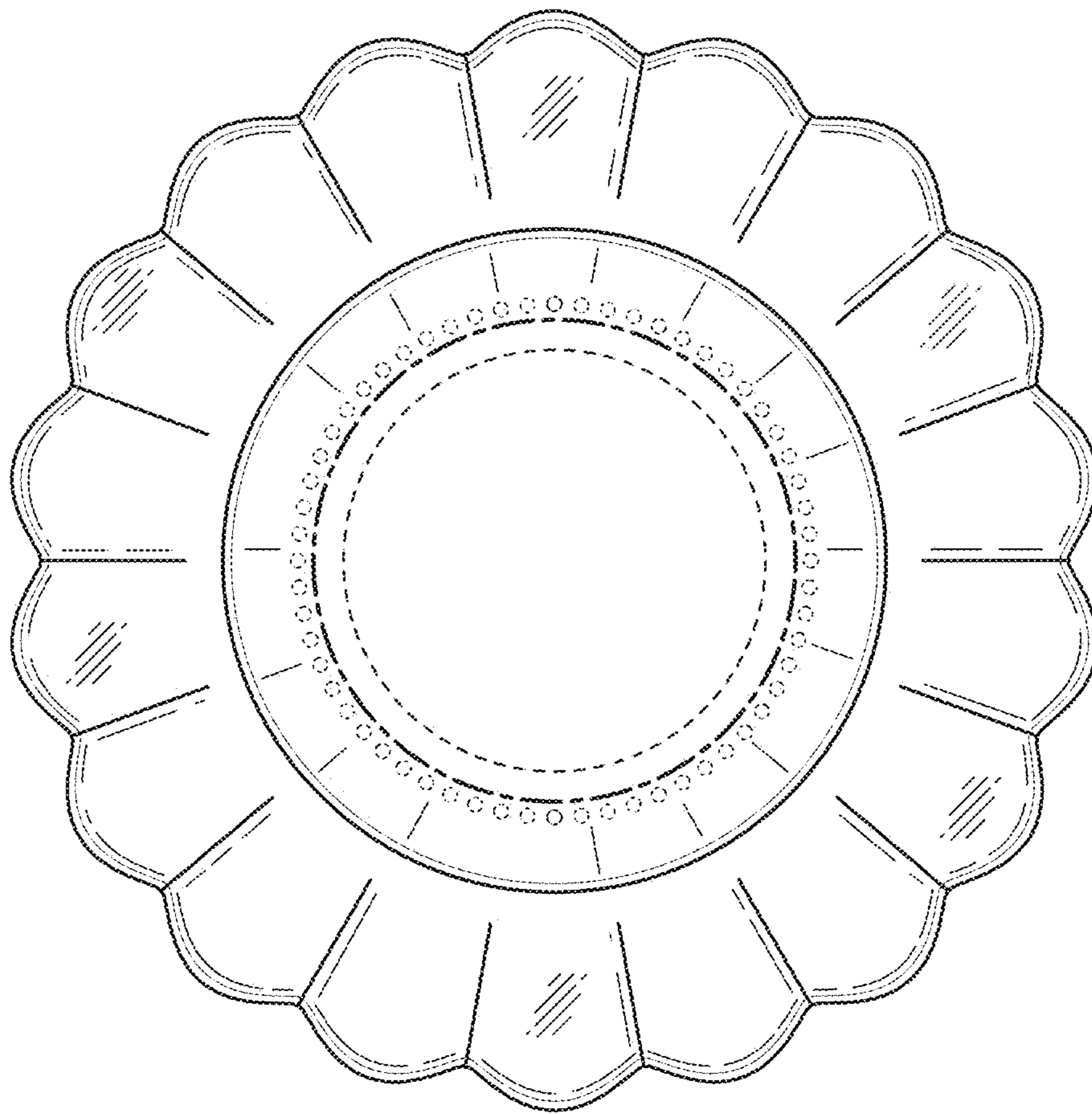

FIG. 8



**FIG. 9**



**FIG. 10**

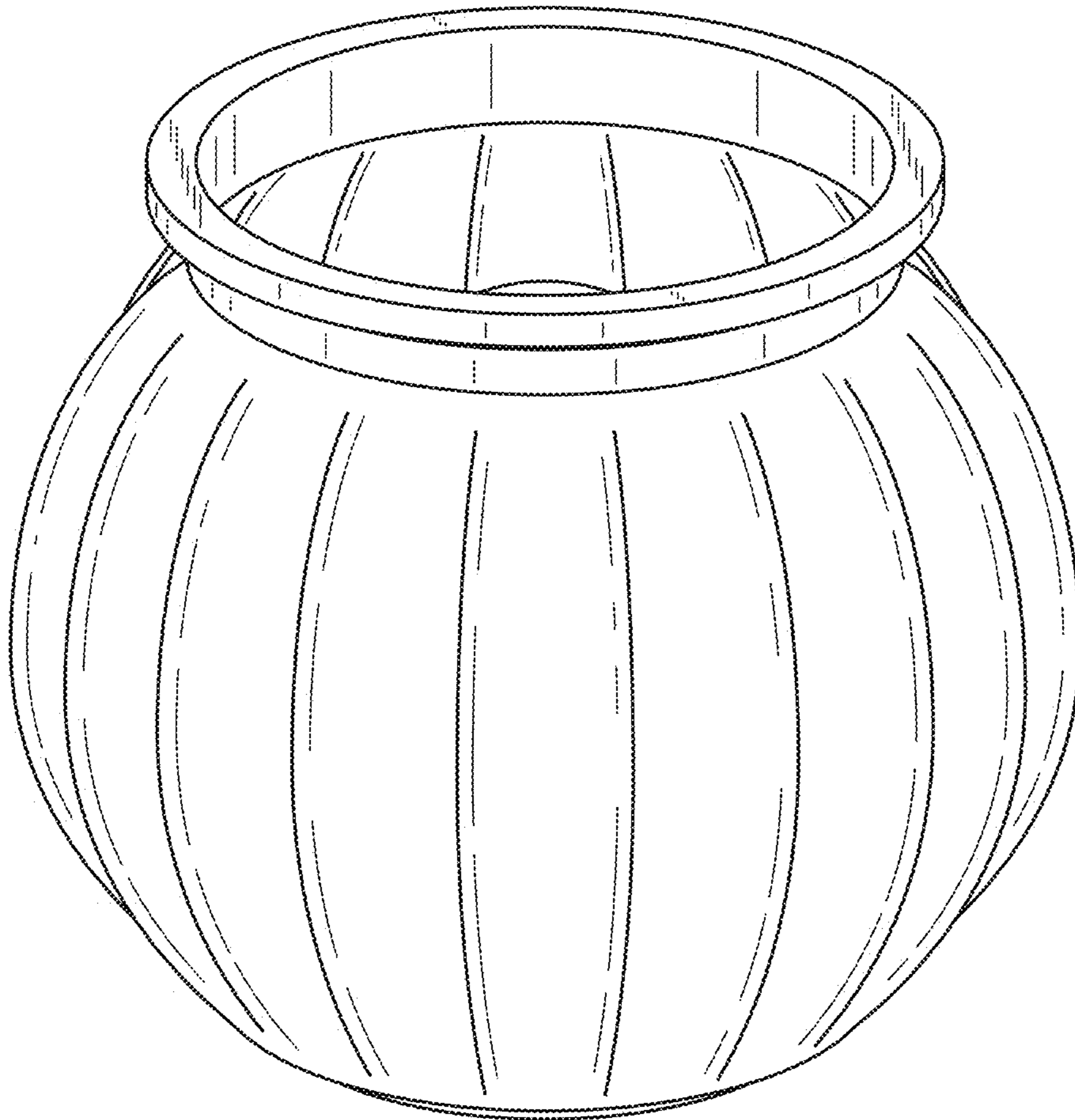

**FIG. 11**

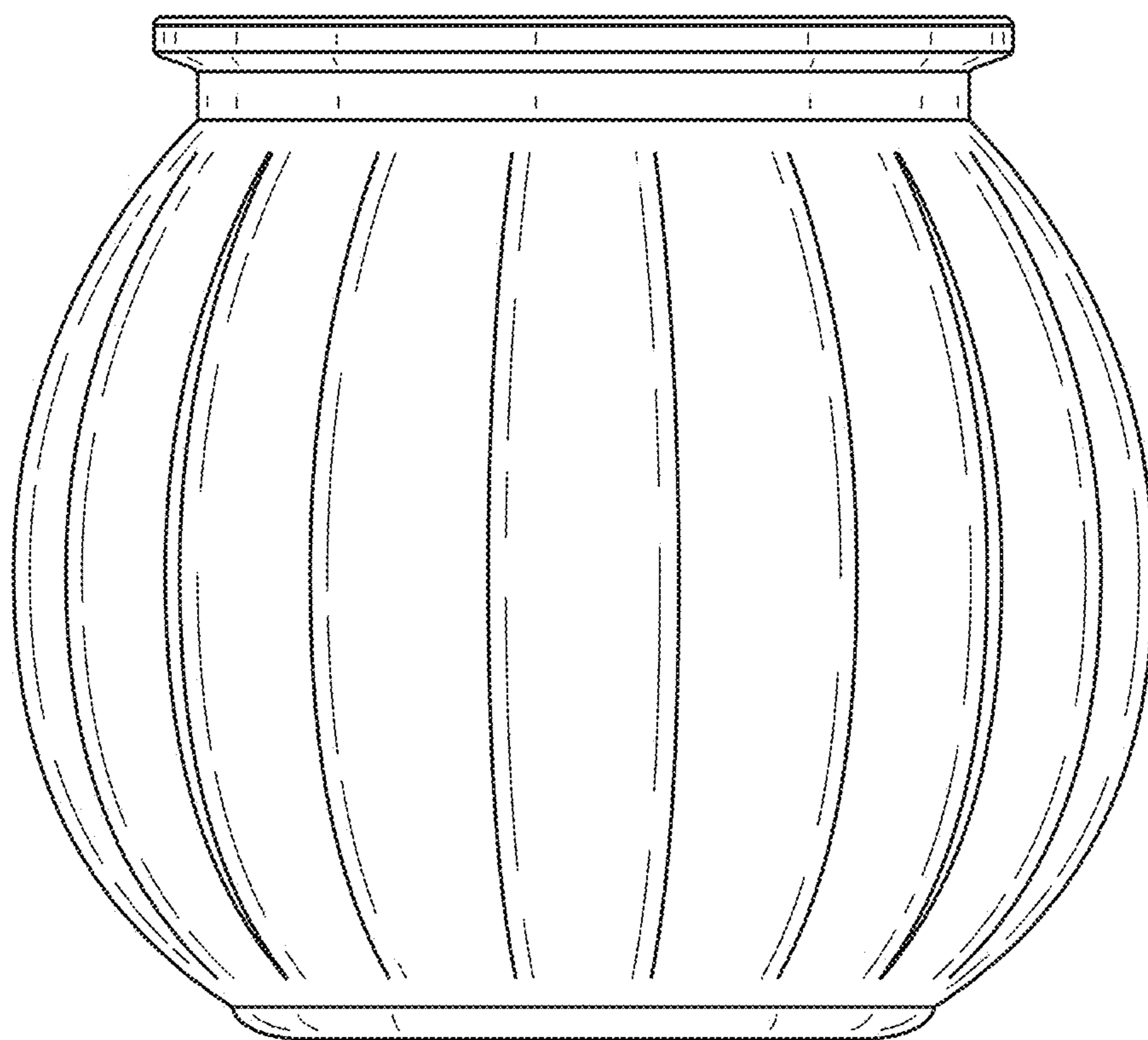

**FIG. 12**

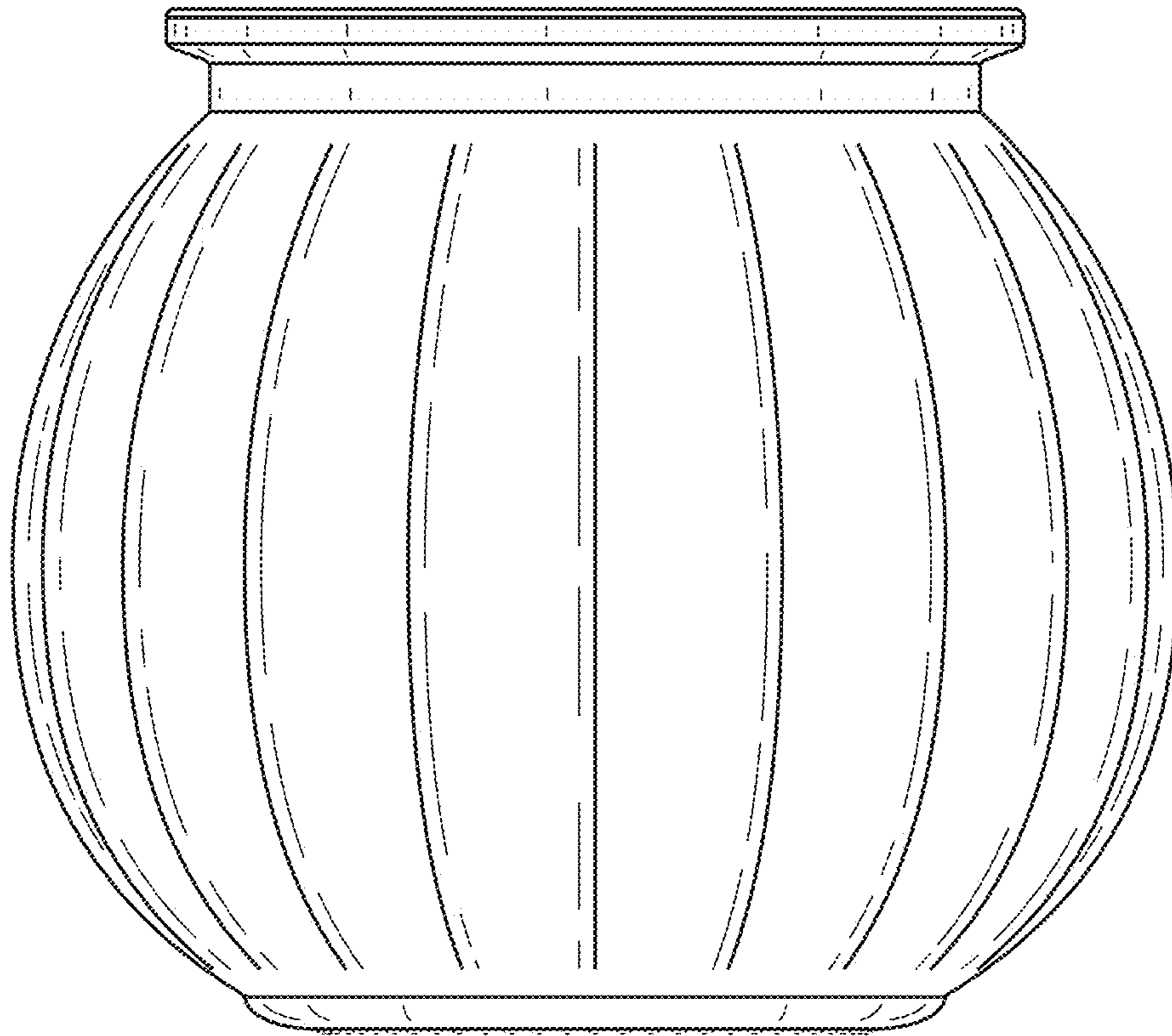

**FIG. 13**

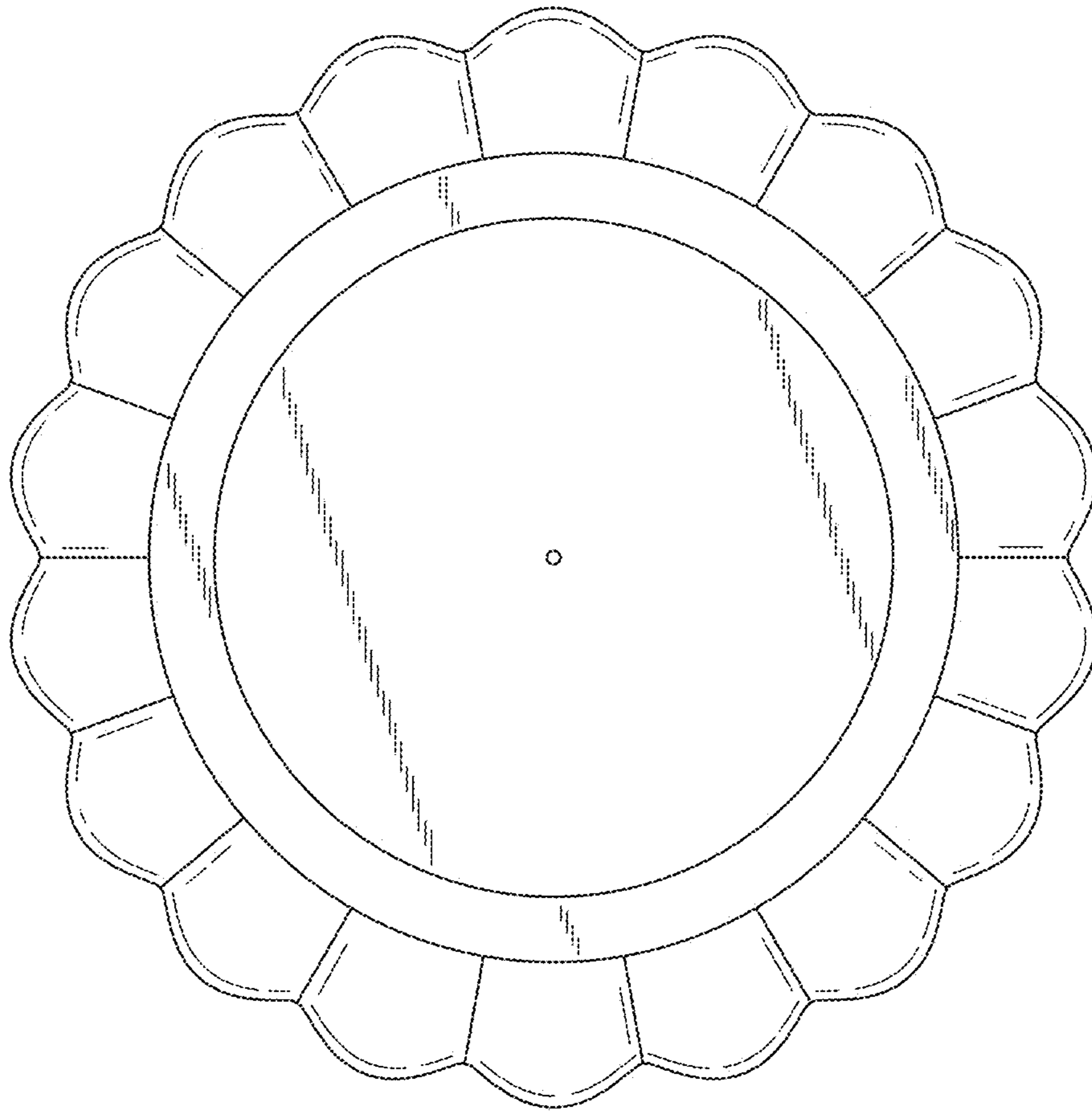

**FIG. 14**



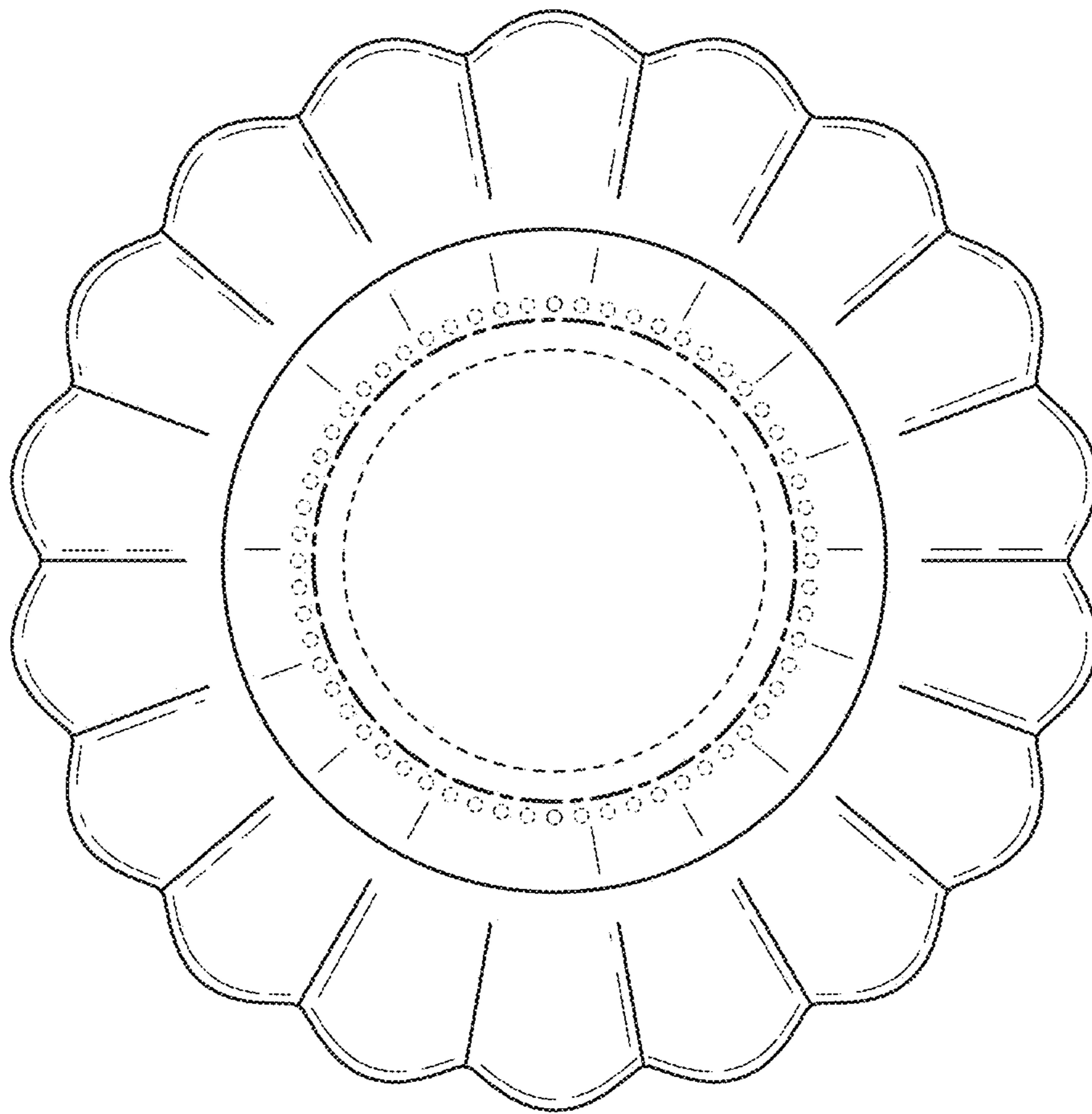
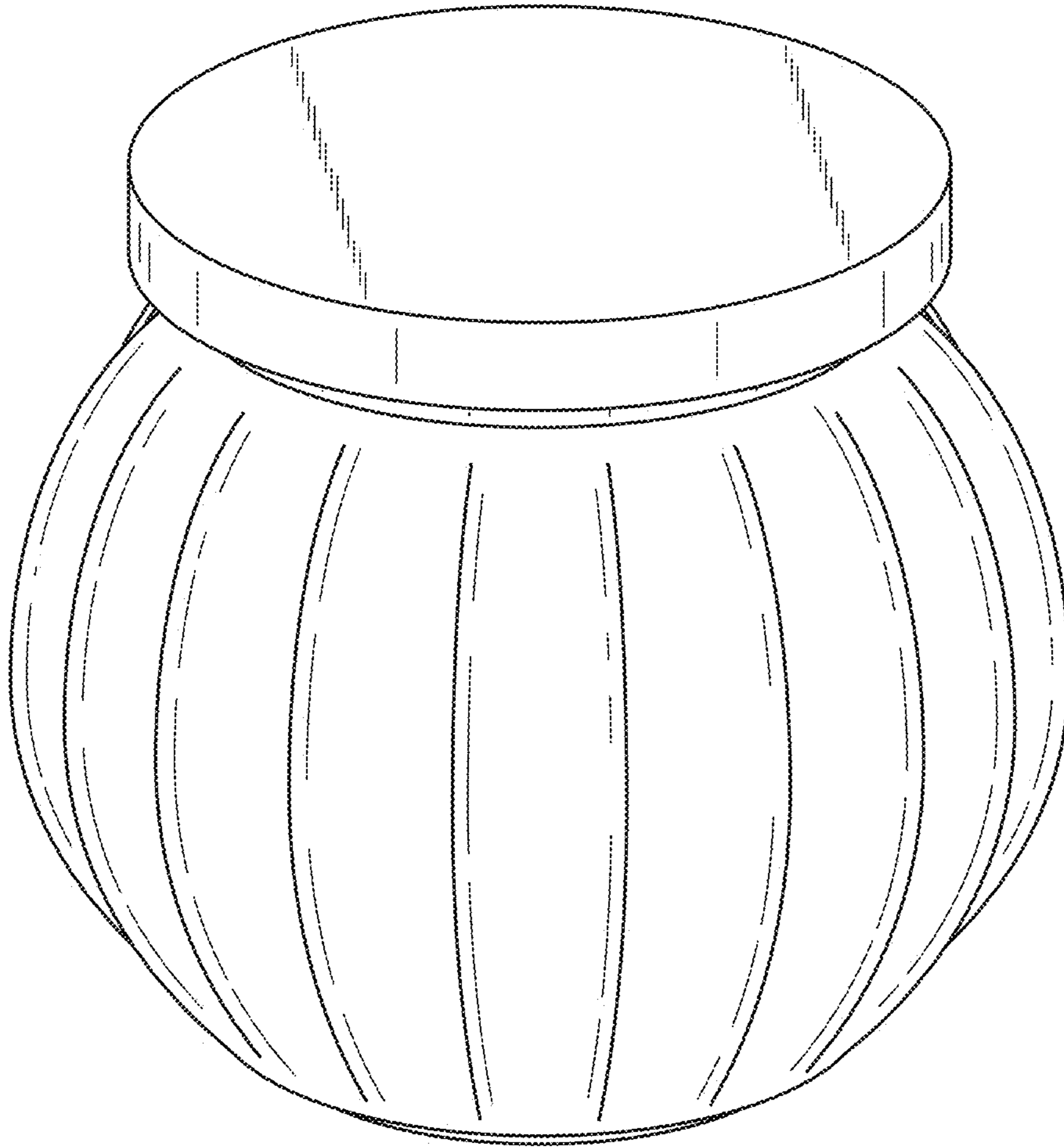
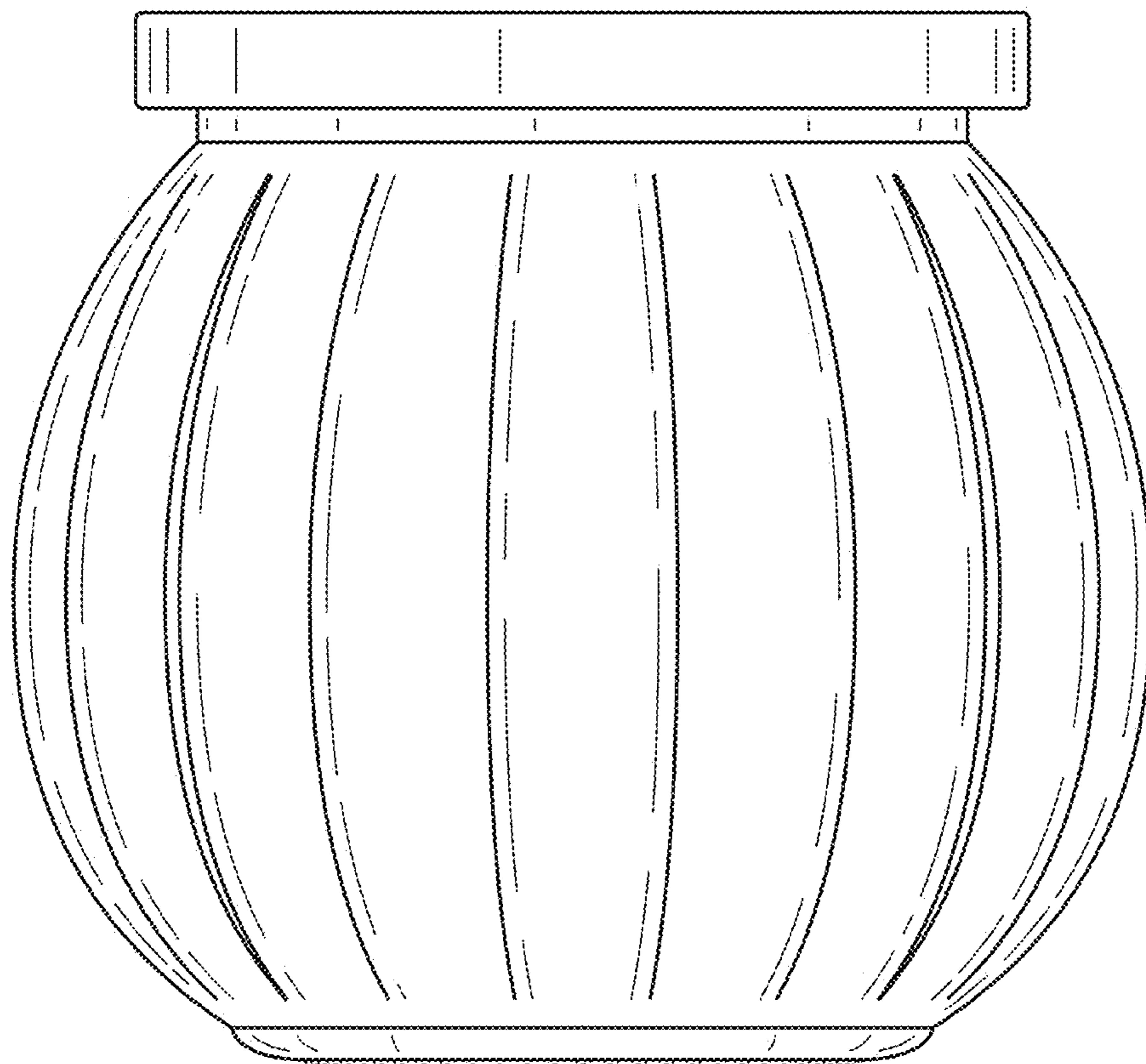

FIG. 15



**FIG. 16**



**FIG. 17**

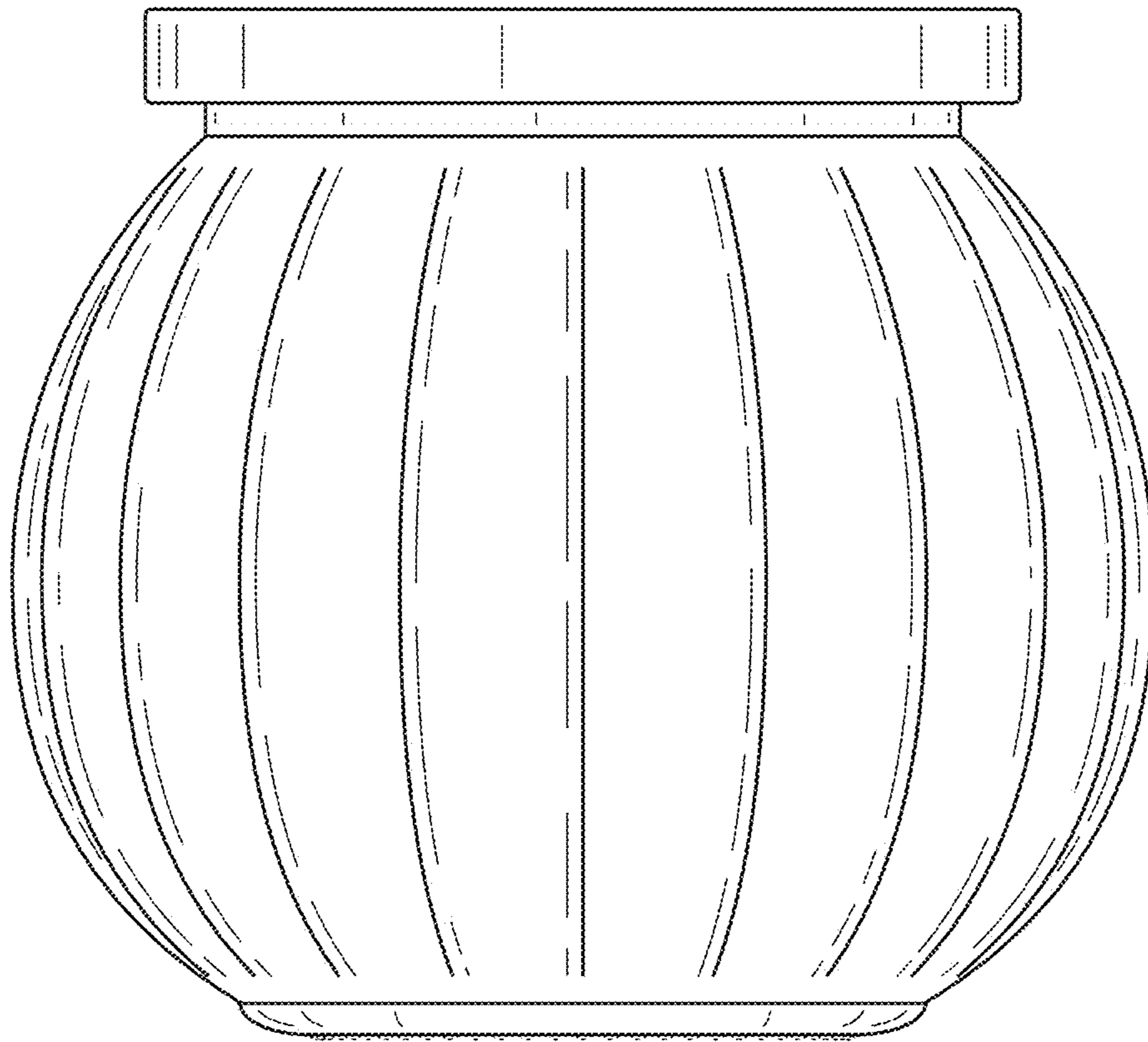

**FIG. 18**

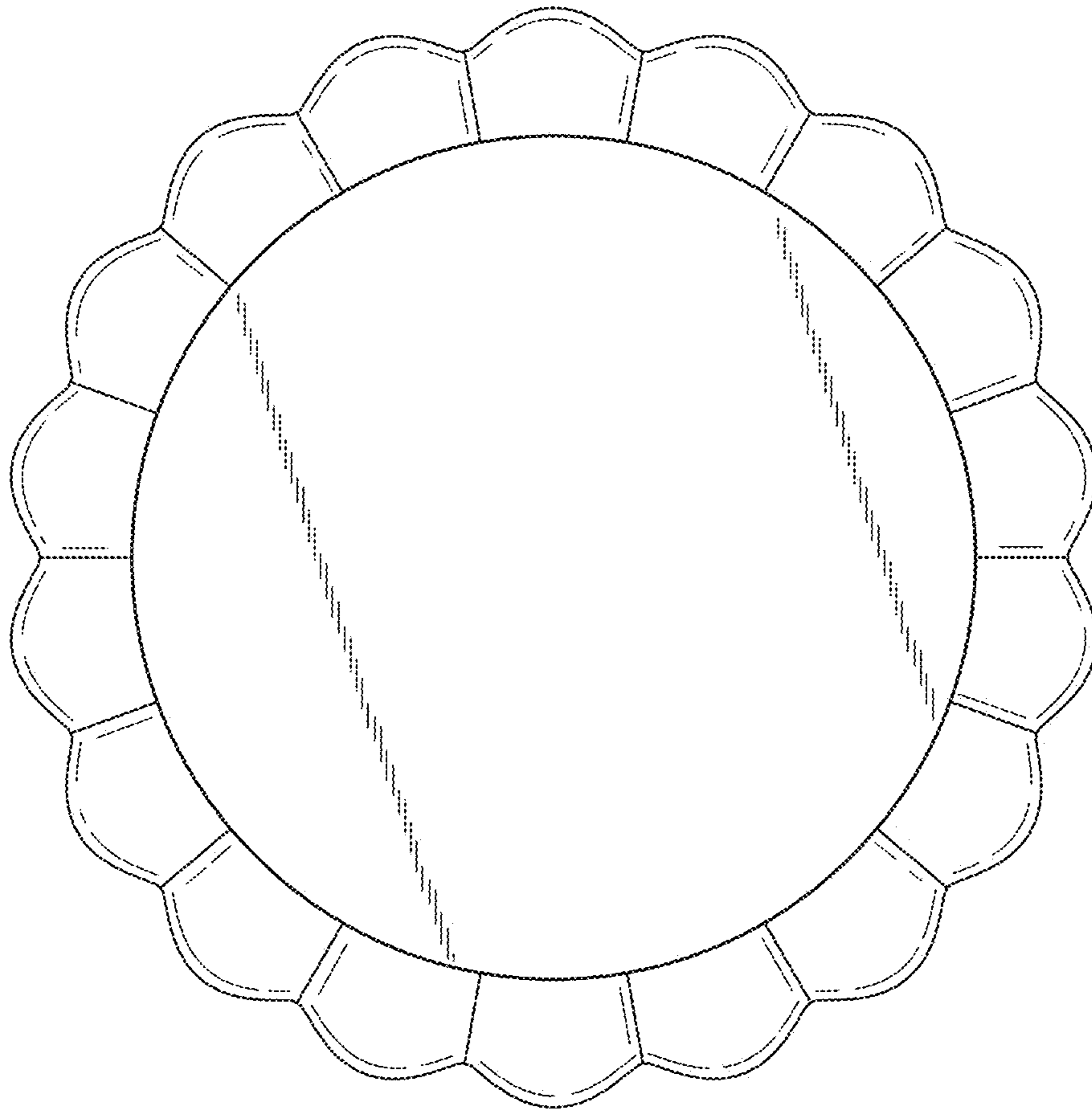

**FIG. 19**

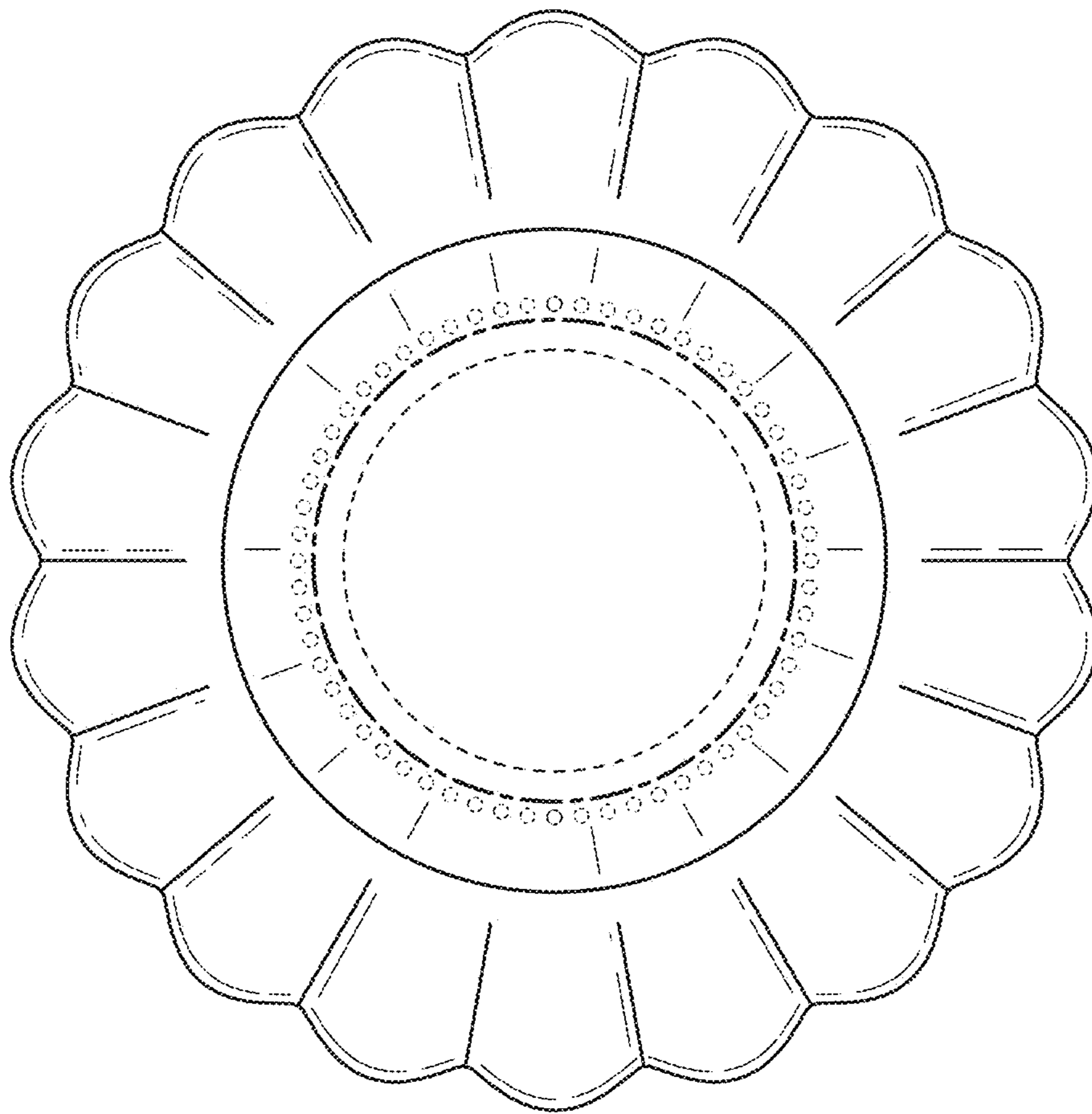

**FIG. 20**