



US00D923105S

(12) **United States Design Patent**
Peng et al.

(10) **Patent No.:** **US D923,105 S**
(45) **Date of Patent:** **** Jun. 22, 2021**

(54) **HANDLEBAR FOR SCOOTER**
(71) Applicant: **NINEBOT (BEIJING) TECH. CO., LTD**, Beijing (CN)
(72) Inventors: **Bo Peng**, Beijing (CN); **Xing Liu**, Beijing (CN); **Jinbo Shao**, Beijing (CN); **Lei Liu**, Beijing (CN)
(73) Assignee: **Ninebot (Beijing) Tech Co., Ltd**, Beijing (CN)

D705,873 S * 5/2014 Grout D21/423
D785,716 S * 5/2017 Herlitz D21/423
D804,581 S * 12/2017 Schindele D21/423
D832,930 S * 11/2018 Shen D21/423
D835,206 S * 12/2018 Lin D21/423
D846,031 S * 4/2019 Droge D21/423
D860,917 S * 9/2019 Tan D21/423
D866,674 S * 11/2019 Li D21/423
D872,191 S * 1/2020 Lee D21/423

(Continued)

Primary Examiner — George D. Kirschbaum
Assistant Examiner — Joseph J Kukella
(74) *Attorney, Agent, or Firm* — Margaret Polson; Polson Intellectual Property Law, PC

(**) Term: **15 Years**

(21) Appl. No.: **35/508,905**

(22) Filed: **Jan. 6, 2020**

(80) **Hague Agreement Data**

Int. Filing Date: **Jan. 6, 2020**
Int. Reg. No.: **DM/206518**
Int. Reg. Date: **Jan. 6, 2020**
Int. Reg. Pub. Date: **Mar. 27, 2020**

(30) **Foreign Application Priority Data**

Jul. 31, 2019 (CN) 201930413732.7

(51) **LOC (13) Cl.** **12-11**

(52) **U.S. Cl.**
USPC **D21/423**

(58) **Field of Classification Search**
USPC D12/85, 107, 109, 110, 111, 112, 113;
D21/423
CPC B62D 51/00; B62D 51/001; B62D 51/02;
B62D 61/06; B62D 61/065; B62D 61/08;
B62K 11/00; B62K 11/007
See application file for complete search history.

(56) **References Cited**

U.S. PATENT DOCUMENTS

D654,965 S * 2/2012 Herlitz D21/423
D692,963 S * 11/2013 Radtke D21/423

(57) **CLAIM**

The ornamental design for a handlebar for scooter, as shown and described.

DESCRIPTION

The patent or application file contains at least one drawing executed in color. Copies of this patent or patent application publication with color drawing(s) will be provided by the Office upon request and payment of the necessary fee.

1.-2. Handlebar for scooter

- 1.1 : Front
- 1.2 : Back
- 1.3 : Left
- 1.4 : Right
- 1.5 : Top
- 1.6 : Bottom
- 1.7 : Perspective
- 2.1 : Front
- 2.2 : Back
- 2.3 : Left
- 2.4 : Right
- 2.5 : Top
- 2.6 : Bottom
- 2.7 : Perspective

1 Claim, 14 Drawing Sheets
(7 of 14 Drawing Sheet(s) Filed in Color)

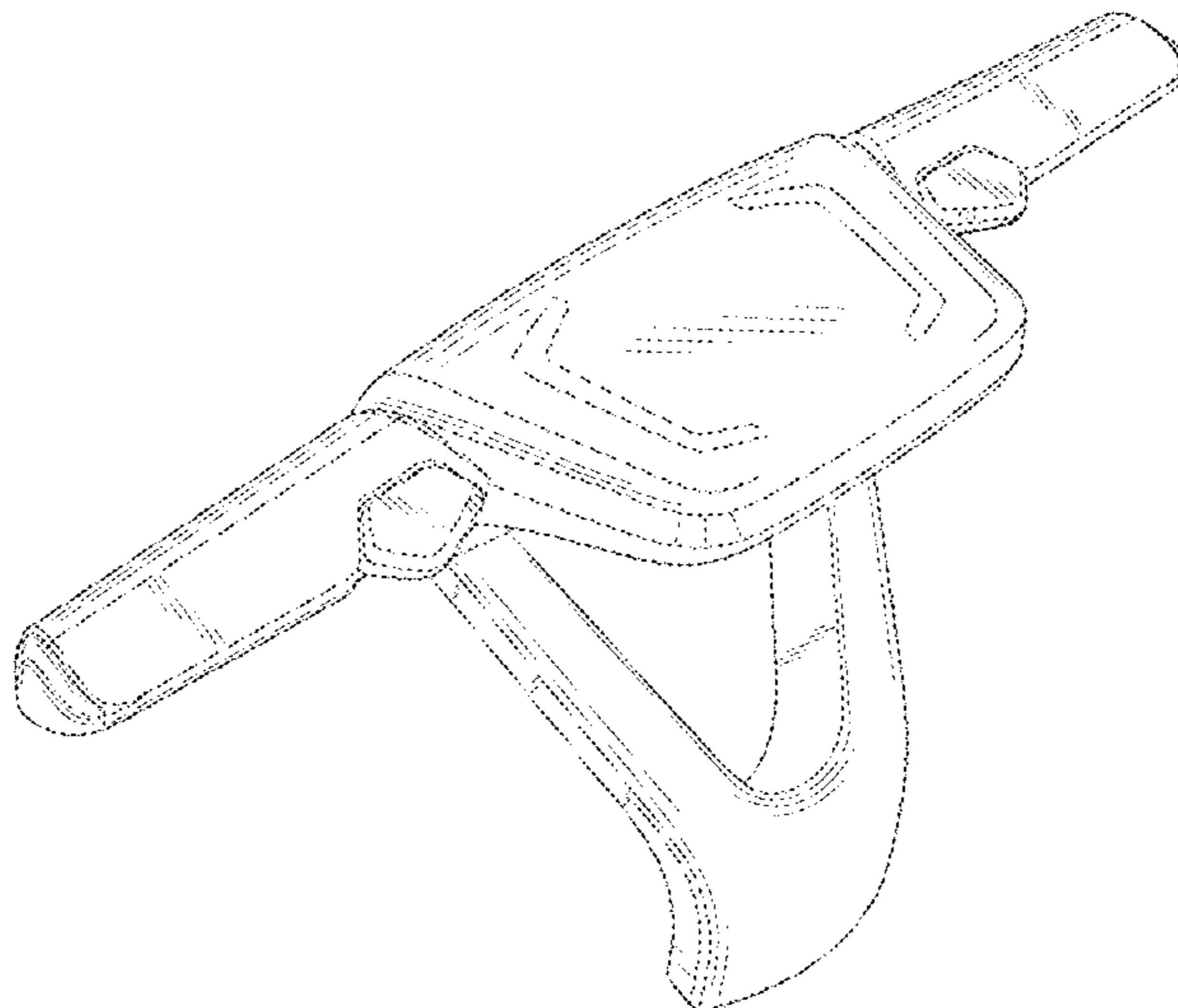

(56)

References Cited

U.S. PATENT DOCUMENTS

D884,085 S *	5/2020	Li	D21/423
D897,445 S *	9/2020	Im	D21/423
D897,446 S *	9/2020	Lee	D21/423
D900,237 S *	10/2020	Lee	D21/423
D908,806 S *	1/2021	Wang	D21/423
D908,807 S *	1/2021	Wang	D21/423

* cited by examiner

1.1

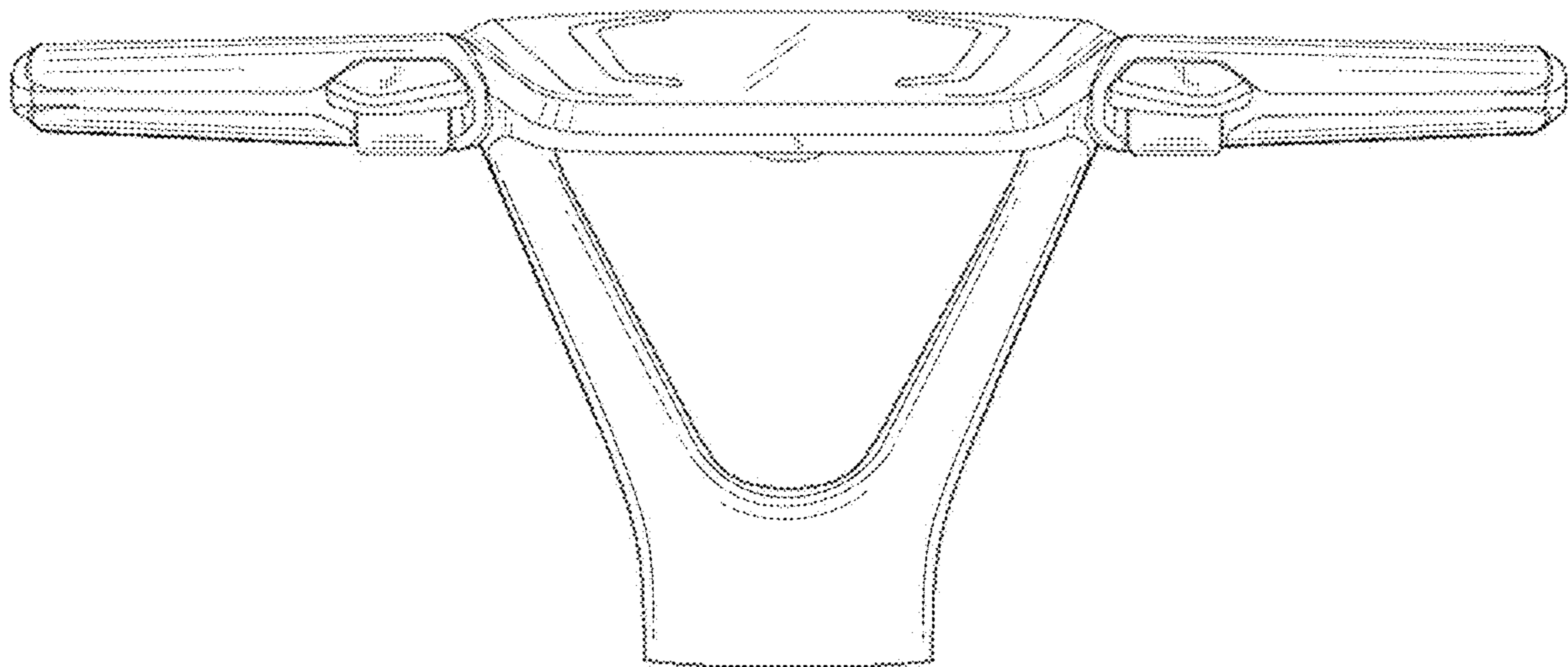

1.2

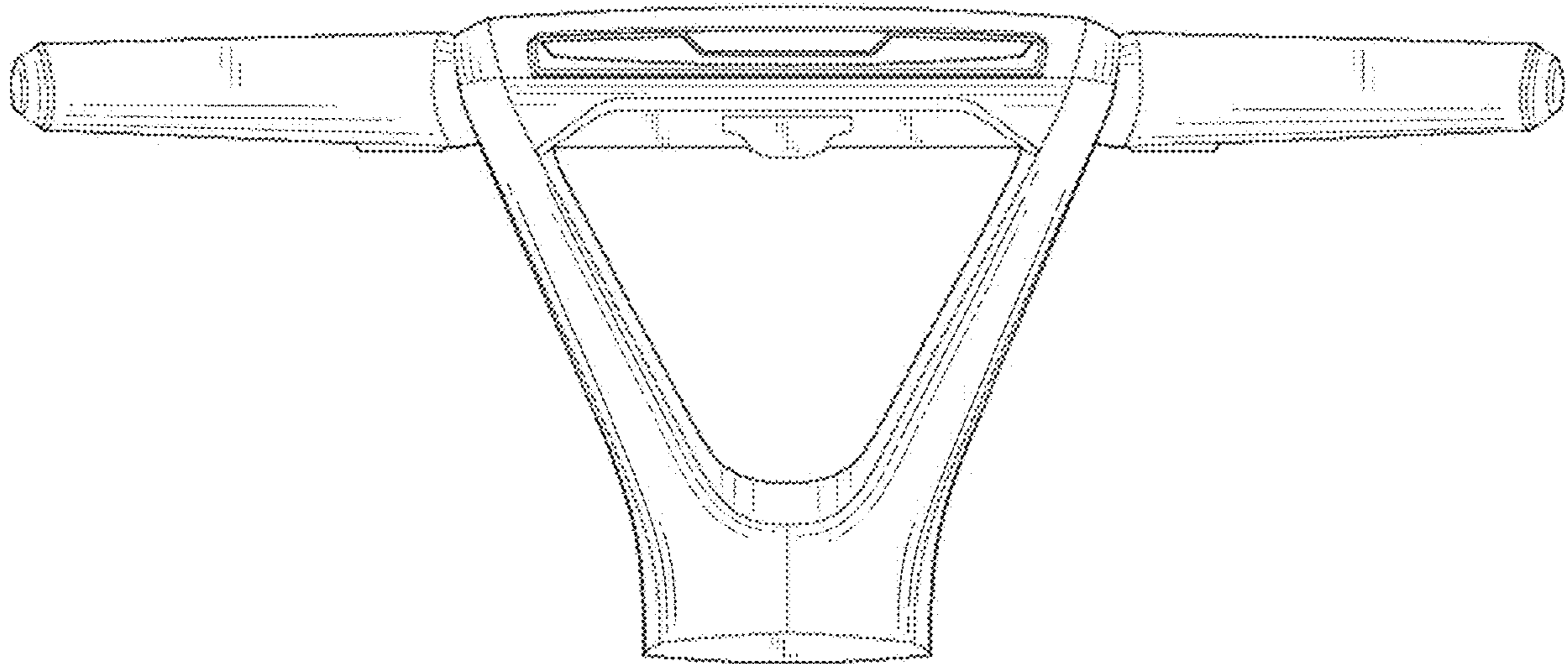

1.3

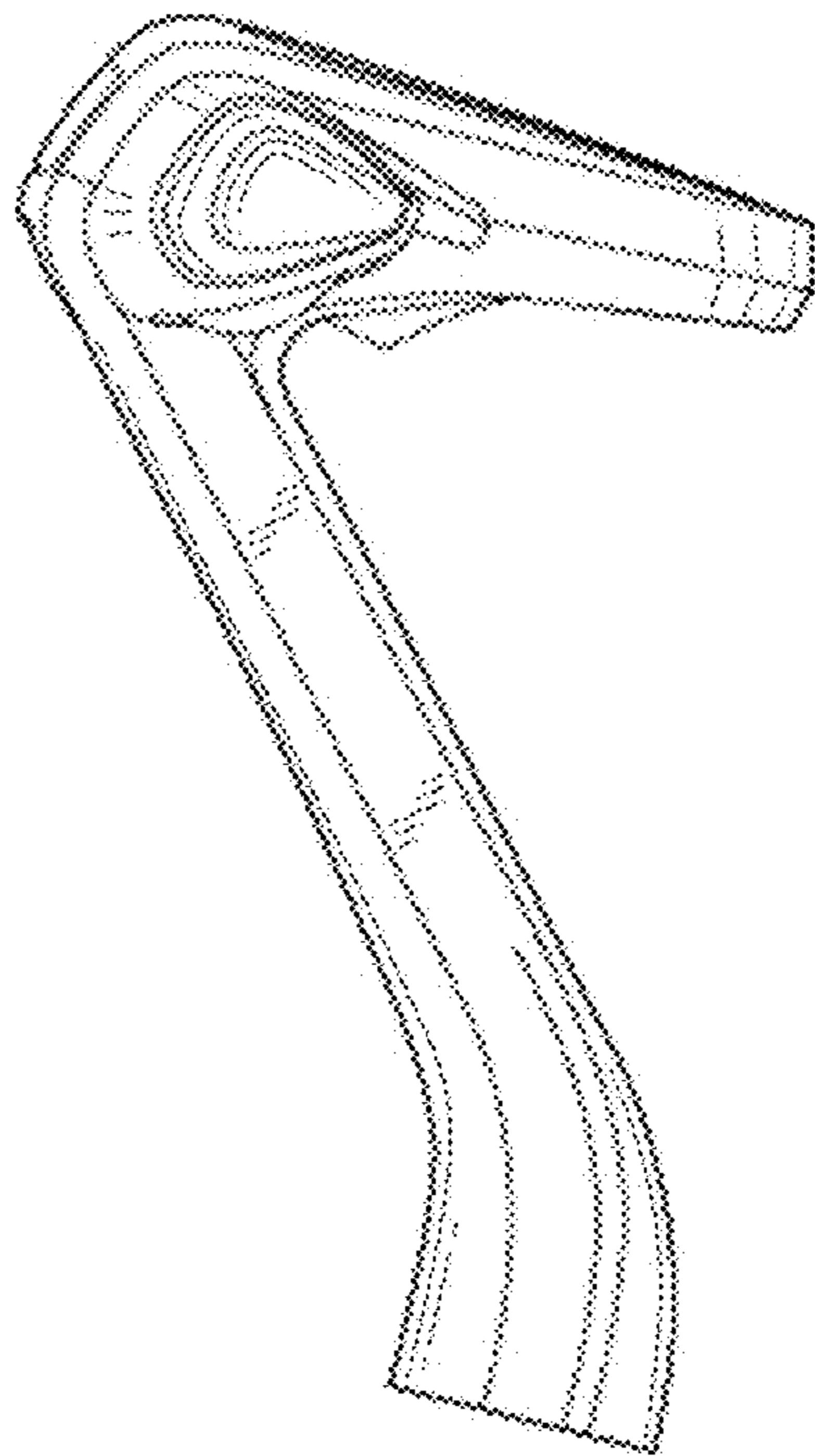

1.4

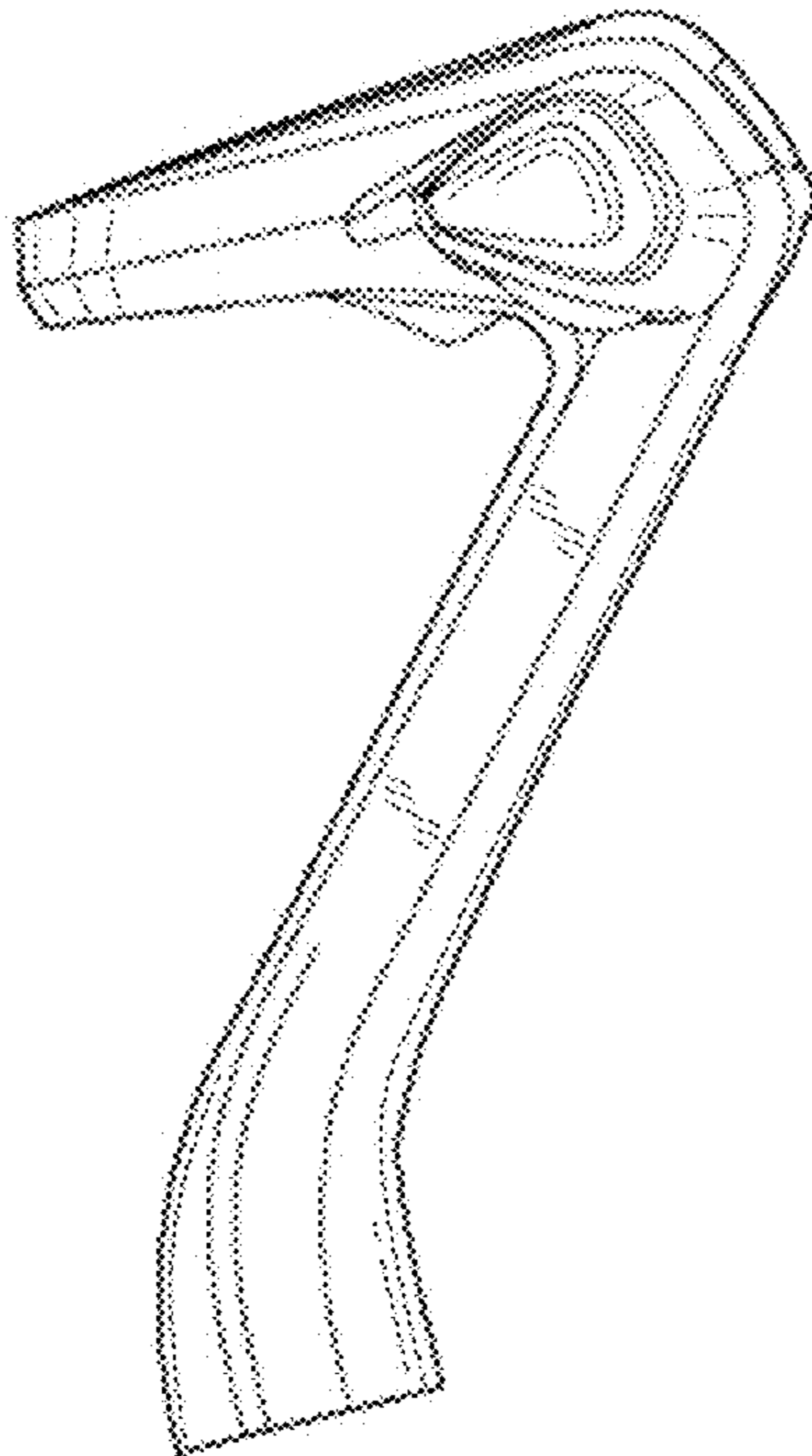

1.5

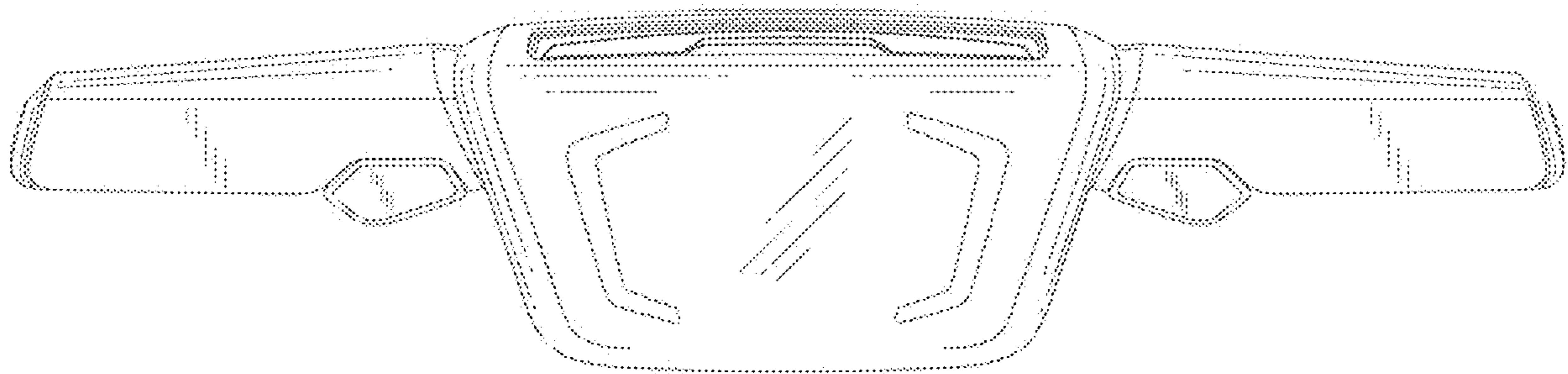

1.6

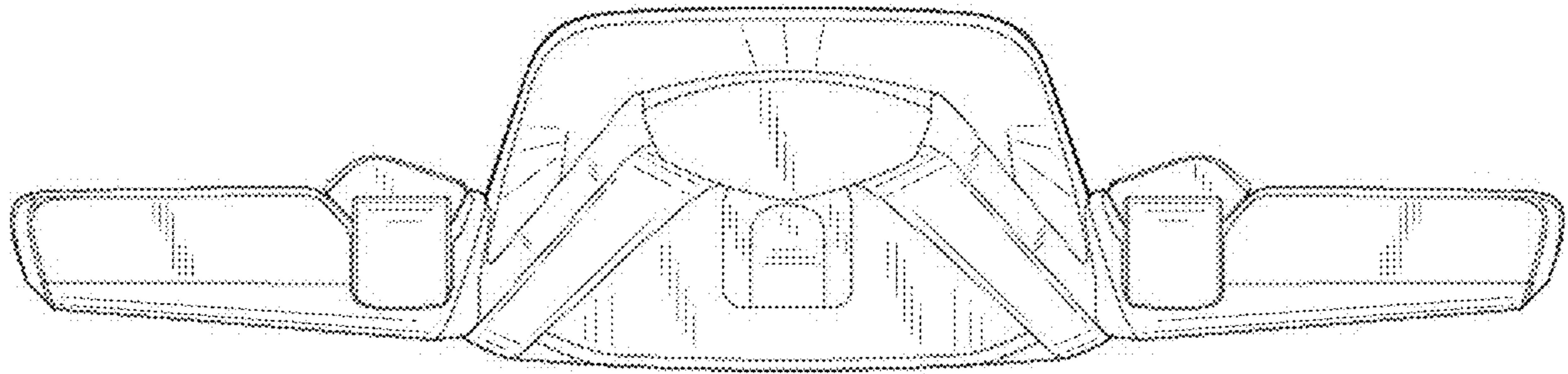

1.7

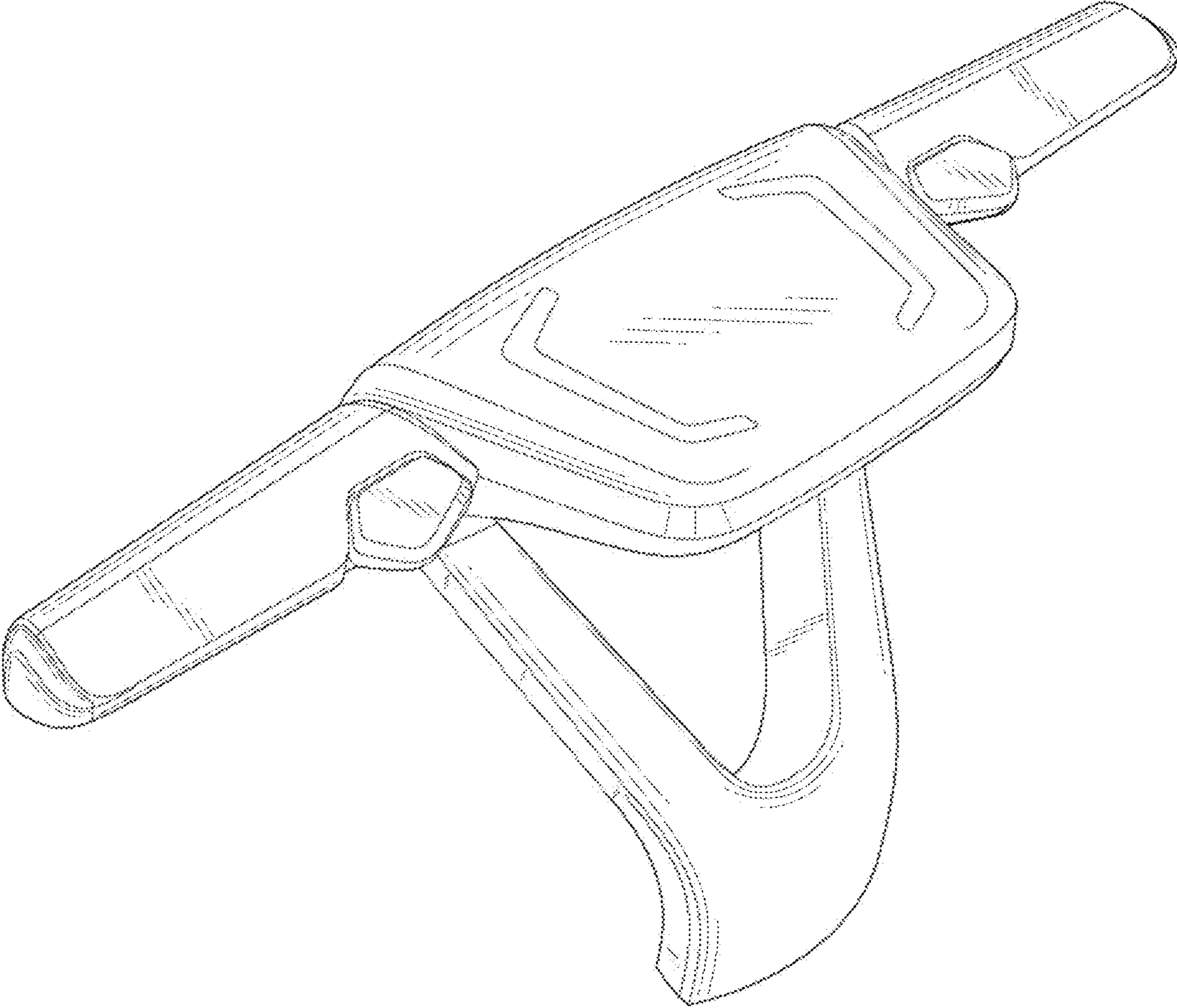

2.1



2.2



2.3

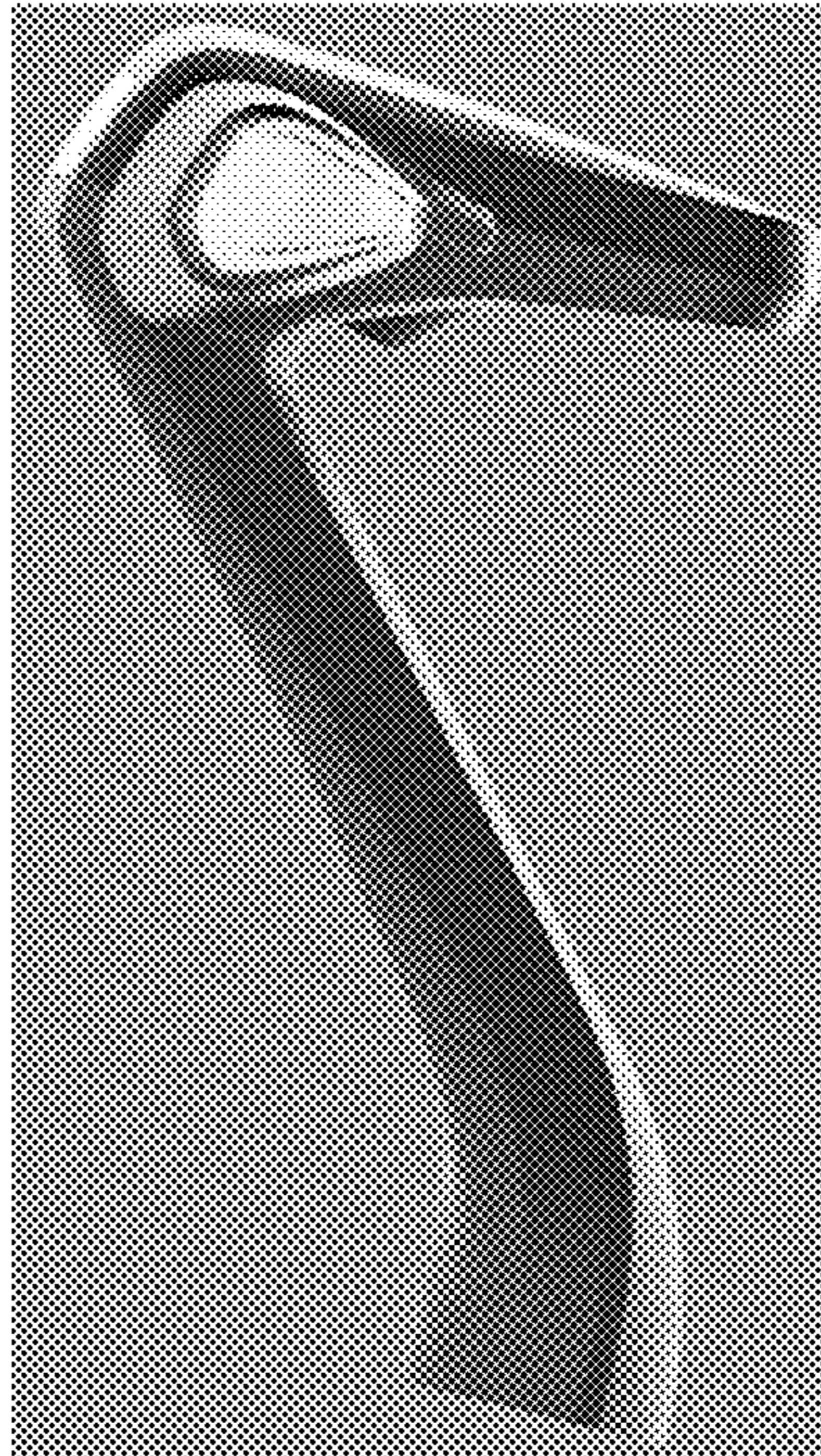

2.4

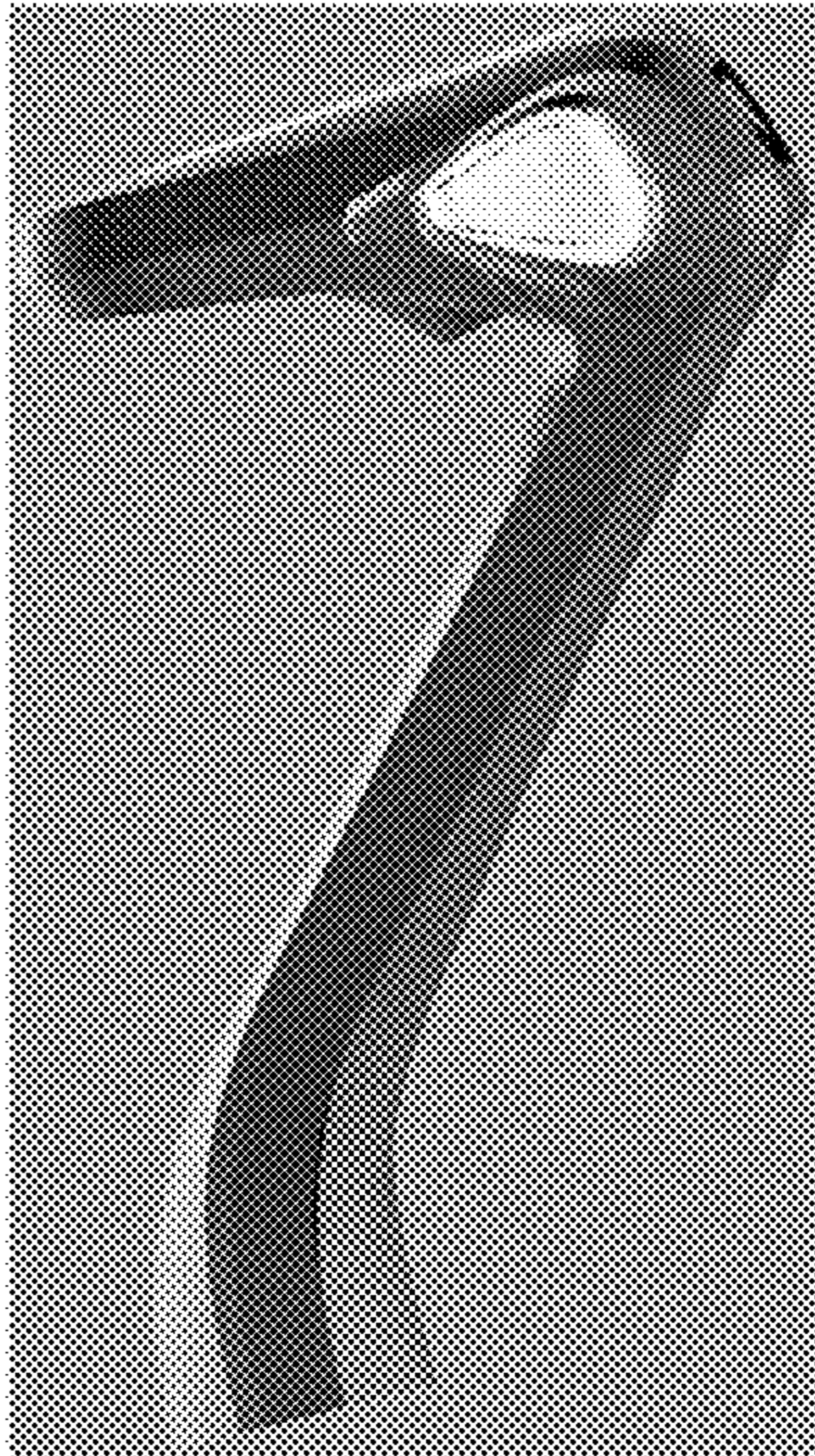

2.5

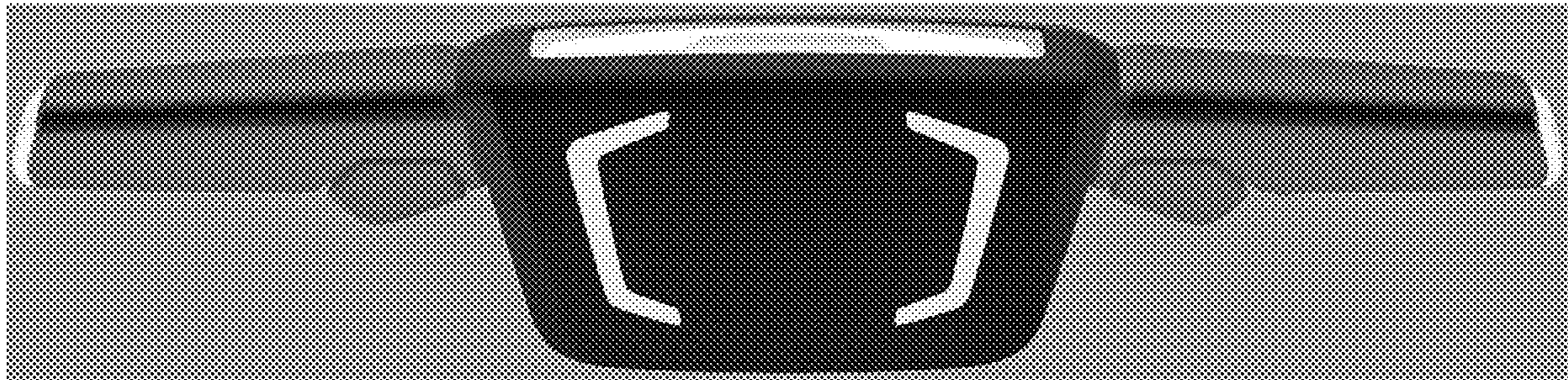

2.6

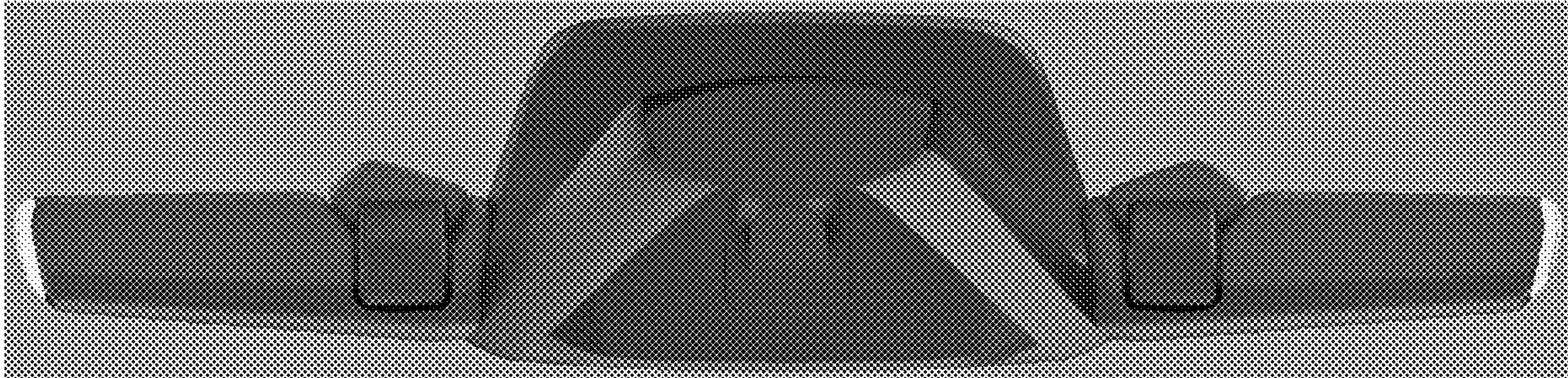

2.7

