



US00D923000S

(12) **United States Design Patent** (10) **Patent No.:** **US D923,000 S**
Lee et al. (45) **Date of Patent:** **** Jun. 22, 2021**

(54) **DISPLAY DEVICE**

(71) Applicants: **Samsung Display Co., Ltd.**, Yongin-si (KR); **UNIST(ULSAN NATIONAL INSTITUTE OF SCIENCE AND TECHNOLOGY)**, Ulsan (KR)

(72) Inventors: **Ja Eun Lee**, Suwon-si (KR); **Gyouhyung Kyung**, Ulsan (KR); **Ji Hyeon Yang**, Ulsan (KR); **Seungbae Lee**, Seoul (KR); **Byeonghwa Choi**, Seoul (KR); **Soo Yeon Seo**, Ulsan (KR); **Minjoong Kim**, Seoul (KR); **Sungryul Park**, Ulsan (KR); **Songil Lee**, Ulsan (KR); **Jihhyeon Yi**, Ulsan (KR); **Donghee Choi**, Ulsan (KR)

(73) Assignees: **Samsung Display Co., Ltd.**, Yongin-si (KR); **UNIST(Ulsan National Institute of Science and Technology)**, Ulsan (KR)

(**) Term: **15 Years**

(21) Appl. No.: **29/649,841**

(22) Filed: **Jun. 1, 2018**

(30) **Foreign Application Priority Data**

Dec. 5, 2017 (KR) 30-2017-0057321

(51) **LOC (13) Cl.** **14-02**

(52) **U.S. Cl.**
USPC **D14/344**

(58) **Field of Classification Search**
USPC ... D14/138 R, 144, 341, 344, 358, 388, 218, D14/485-495; D10/30-39, 70, 98;
(Continued)

(56) **References Cited**

U.S. PATENT DOCUMENTS

D560,686 S * 1/2008 Kim D14/496
D595,254 S * 6/2009 Roberts D14/138 AA
(Continued)

OTHER PUBLICATIONS

TCL is working on a foldable phone that bends into a smartwatch, posted Feb. 16, 2019, [retrieved Jun. 8, 2020]. Retrieved from Internet, <URL: <https://www.cnet.com/news/tcl-is-working-on-a-foldable-phone-that-transforms-into-a-smartwatch/>>.*

(Continued)

Primary Examiner — Sheryl Lane

Assistant Examiner — Calvin E Vansant

(74) *Attorney, Agent, or Firm* — Lewis Roca Rothgerber Christie LLP

(57) **CLAIM**

The ornamental design for display device, as shown and described.

DESCRIPTION

FIG. 1 is a perspective view of the display device according to the present design;

FIG. 2 is a front view thereof;

FIG. 3 is a rear view thereof;

FIG. 4 is a left side view thereof, with the right view being a mirror image thereof;

FIG. 5 is a top view thereof;

FIG. 6 is a bottom view thereof;

FIG. 7 is another perspective view thereof;

FIG. 8 is a perspective view thereof, shown in a condition of use; and,

FIG. 9 is an alternate, bent configuration of the display device, shown with the lower portion removed for ease of illustration.

The broken line showing of a hand in FIG. 9 depicts an environment of use. The remaining broken lines shown in the drawings depict portions of the display device. The broken lines form no part of the claimed design.

1 Claim, 9 Drawing Sheets

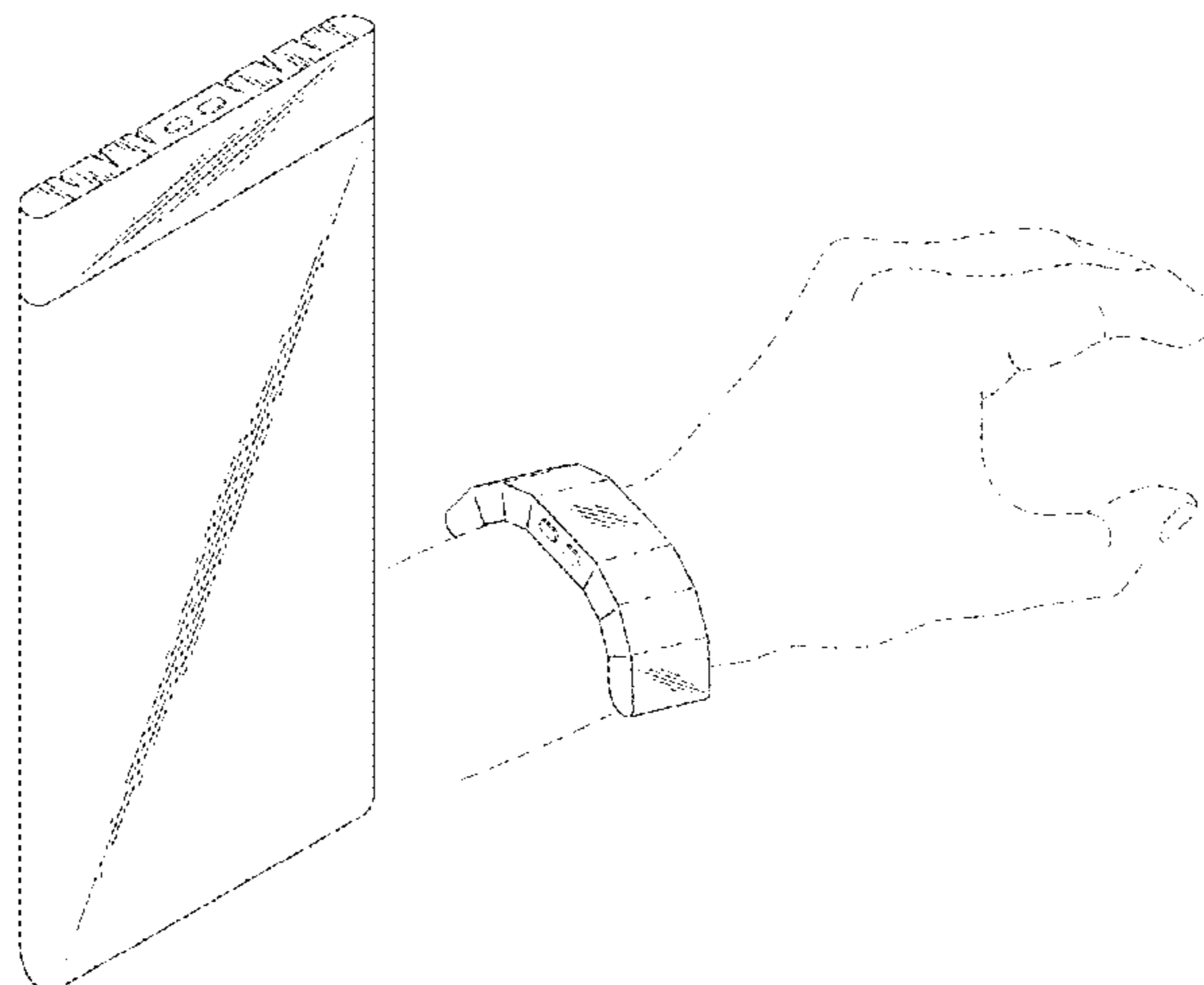

(58) **Field of Classification Search**

USPC D11/3, 4, 26, 93–94, 78.1, 79, 86;
 D24/167, 169, 186–187, 164
 CPC A41D 1/002; A41D 19/0034; G06F 1/04;
 G06F 1/08; G06F 1/10; G06F 1/14; G06F
 1/1626; G06F 1/1628; G06F 1/163; G06F
 1/1635; G06F 1/3203; G06Q 20/10;
 G06Q 20/12; G06Q 20/108; G06Q
 20/145; H04B 1/3833; H04B 1/385;
 H04B 1/3888; H04M 1/02; H04M 1/03;
 H04M 1/04; H04M 1/05; H04M 1/667;
 H04M 1/6058; Y02B 60/1217

See application file for complete search history.

(56) **References Cited**

U.S. PATENT DOCUMENTS

9,265,310	B2 *	2/2016	Lam	H04W 84/18
D757,001	S *	5/2016	Kim	D14/138 R
9,383,829	B2 *	7/2016	Liu	G06F 1/1626
9,848,494	B2 *	12/2017	Huitema	H05K 1/183
9,989,995	B2 *	6/2018	Kwak	G06F 1/1643

10,185,364	B2 *	1/2019	Seo	G06F 1/1652
D841,612	S *	2/2019	Kwon	D14/138 AB
10,241,105	B2 *	3/2019	Kwak	G01N 33/4972
10,303,218	B2 *	5/2019	Jones	G06F 1/1641
D850,443	S *	6/2019	Kwon	D14/344
10,345,853	B2 *	7/2019	Wu	A44C 5/0015

OTHER PUBLICATIONS

Samsung's next foldable smartphone could double up as a SMARTWATCH, posted Mar. 12, 2019, [retrieved Jun. 8, 2020].

Retrieved from Internet, <URL: <https://www.mirror.co.uk/tech/samsungs-next-foldable-smartphone-could-14123693> >.*

New flexible smartphone can be rolled up onto your wrist, posted Jan. 12, 2017, [retrieved Jun. 8, 2020]. Retrieved from Internet, <URL : <https://www.dnaindia.com/technology/report-new-flexible-smartphone-can-be-rolled-up-onto-your-wrist-2291785> >.*

Lenovo Cplus & Folio are the Foldable & Bendable Concepts from the Future, posted Jun. 11, 2016, [retrieved Jun. 8, 2020]. Retrieved

from Internet, <URL: <https://phoneradar.com/lenovo-cplus-folio-foldable-bendable-concepts-future/> >.*

* cited by examiner

FIG. 1

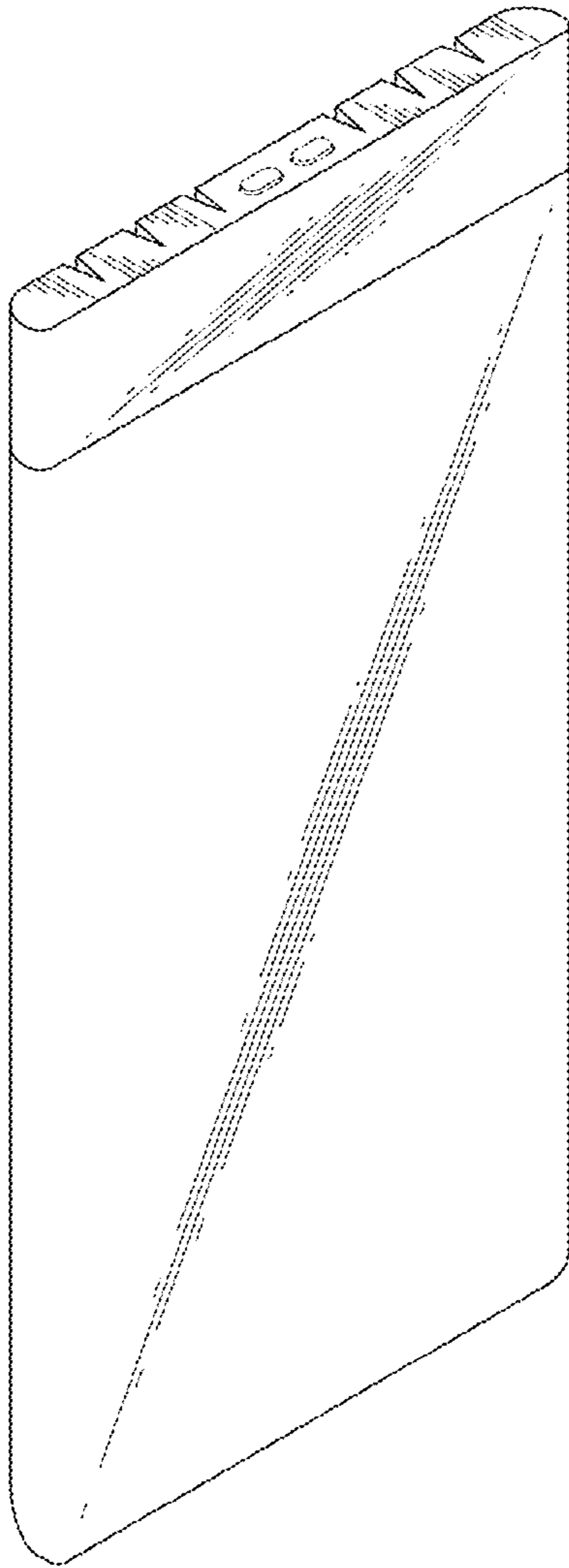

FIG. 2

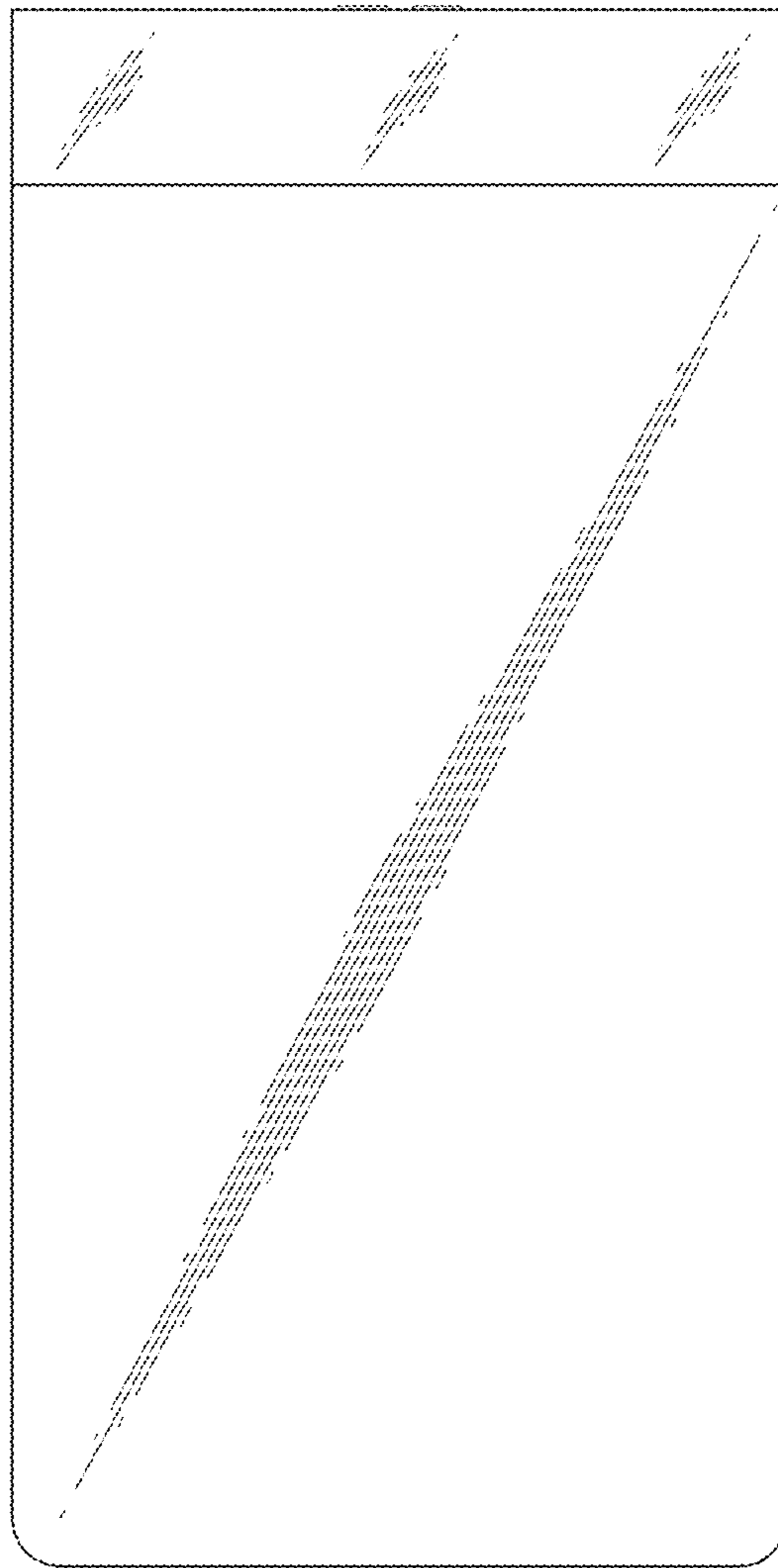

FIG. 3

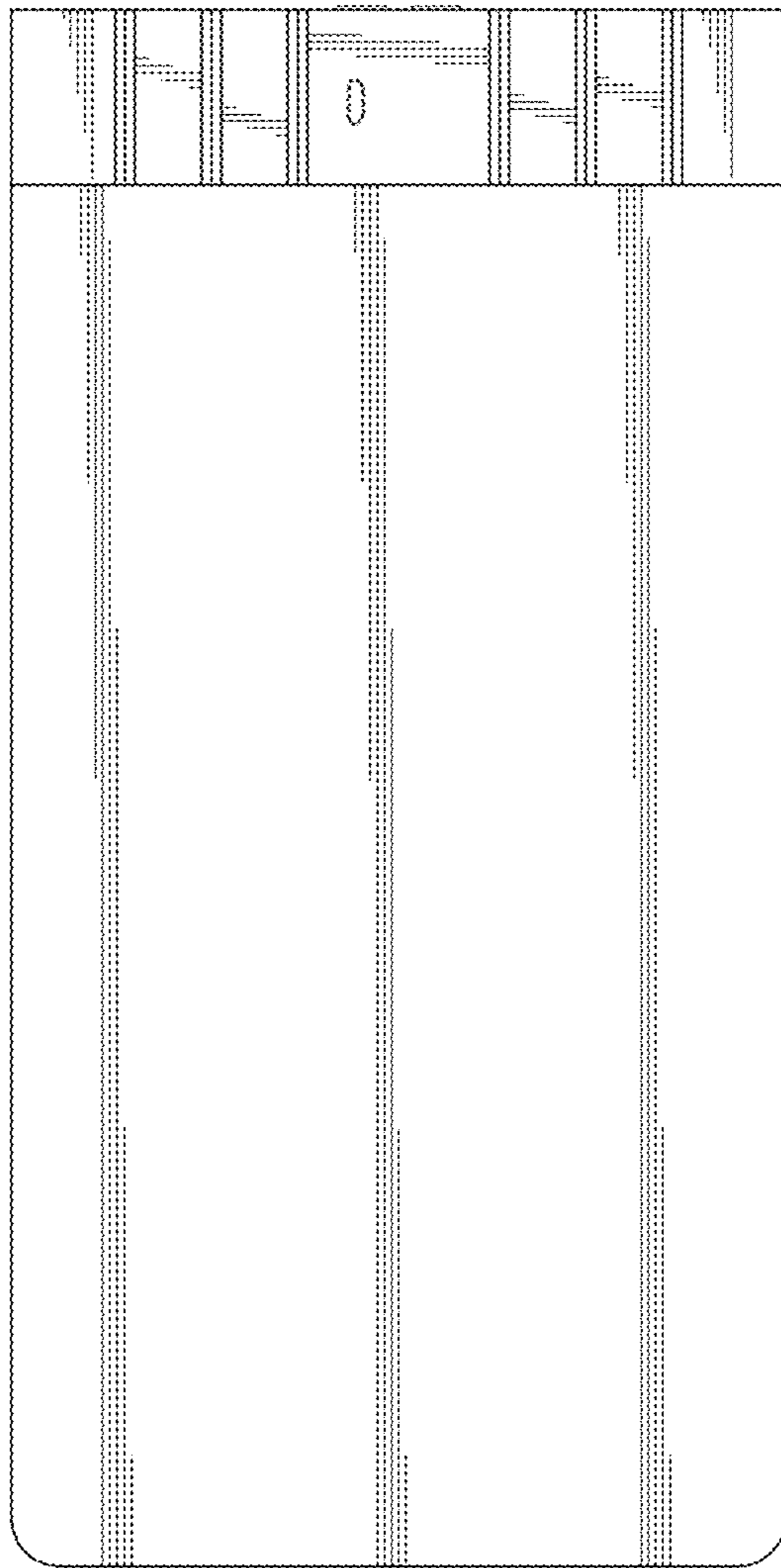

FIG. 4

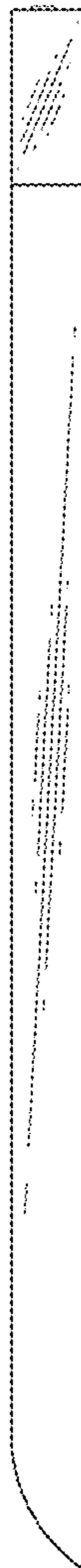

FIG. 5

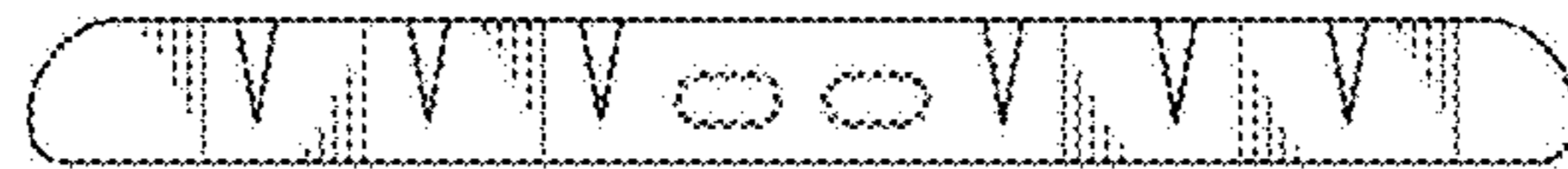

FIG. 6

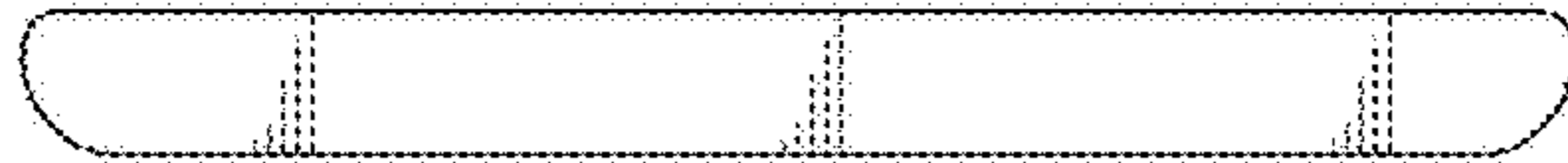

FIG. 7

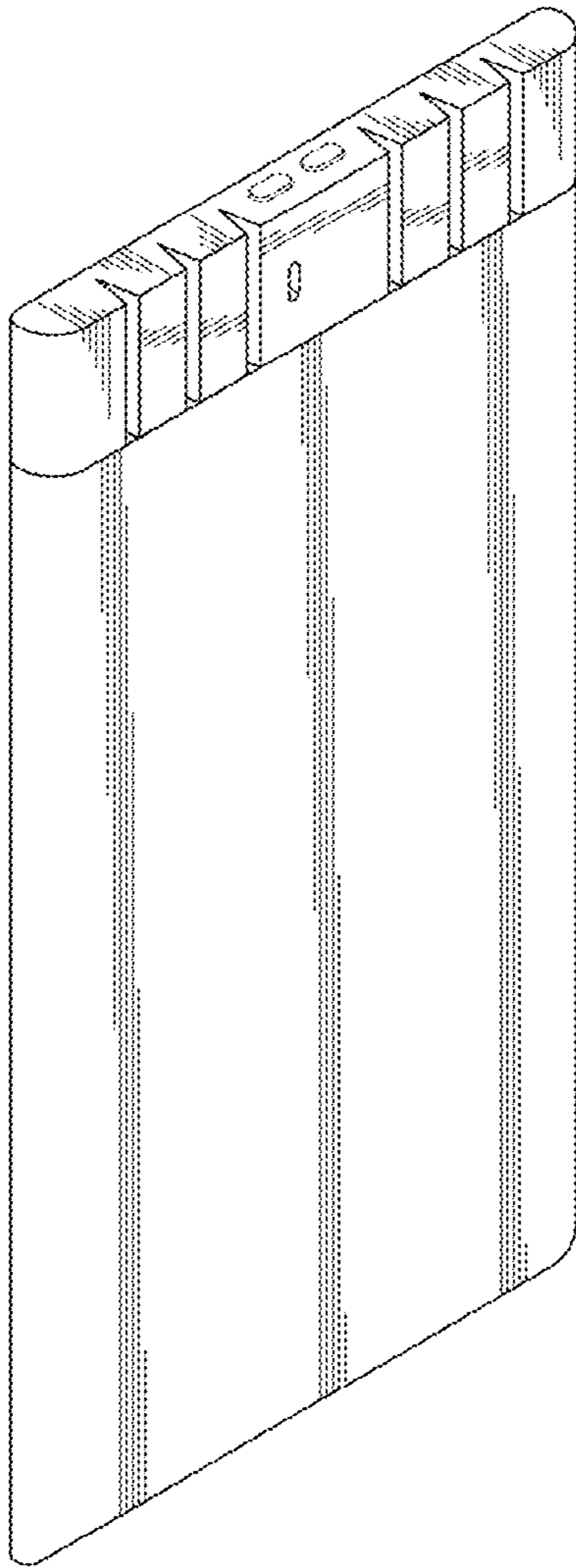

FIG. 8

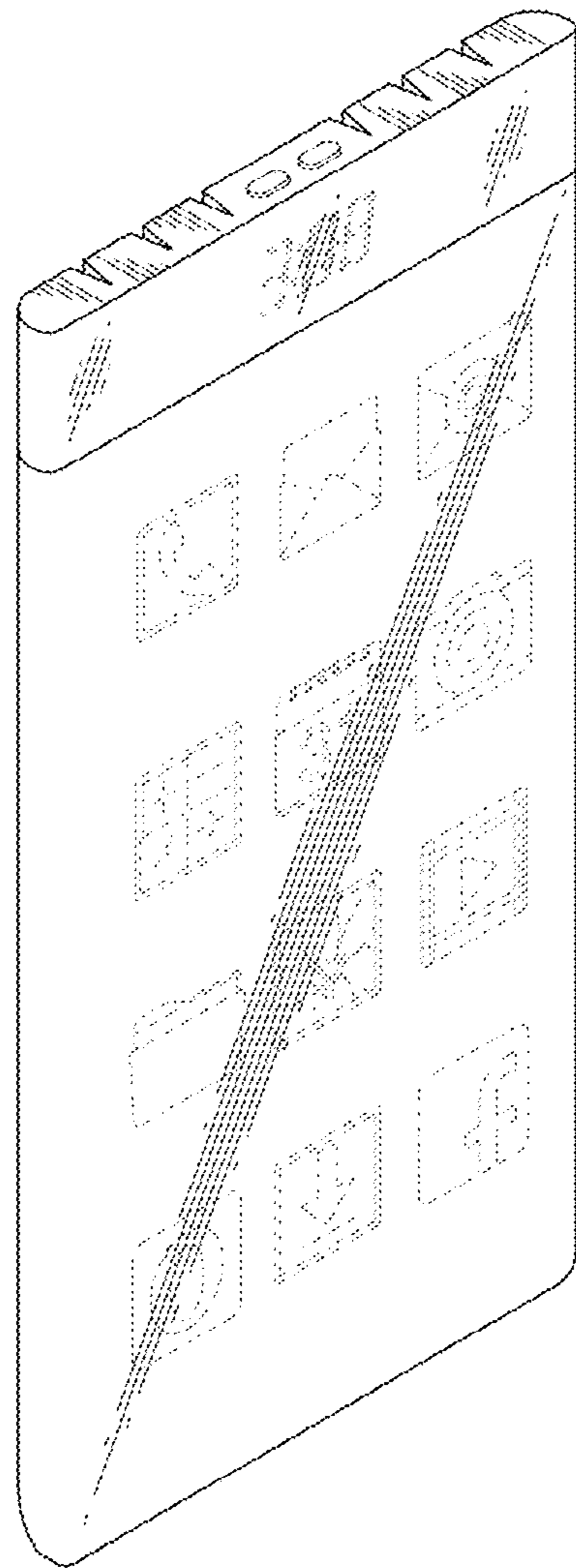

FIG. 9

