



US00D922850S

(12) **United States Design Patent**
Chen

(10) **Patent No.:** **US D922,850 S**

(45) **Date of Patent:** **** Jun. 22, 2021**

- (54) **DOOR LOCK**
- (71) Applicant: **ZHONGSHAN HYDI ARROW LOCK CO., LTD**, Zhongshan (CN)
- (72) Inventor: **Qiang Chen**, Tongren (CN)
- (73) Assignee: **ZHONGSHAN HYDI ARROW LOCK CO., LTD**, Zhongshan (CN)

D709,351 S *	7/2014	Le	D8/331
8,869,574 B2 *	10/2014	Schmidt-Lackner	E05B 13/001
			70/129
9,303,432 B2 *	4/2016	Sambar	E05B 1/003
9,487,971 B2 *	11/2016	Quach	E05B 47/0005
D793,205 S *	8/2017	Ho	D8/330
9,727,328 B2 *	8/2017	Johnson	G06F 8/65
D806,515 S *	1/2018	Backhaus	D8/331
D817,739 S *	5/2018	Ocklenburg	D8/343
10,049,520 B2 *	8/2018	Gardiner	G07C 9/00571
D837,031 S *	1/2019	Cavanna	D8/331
10,329,795 B2 *	6/2019	Roatis	E05B 15/0013
10,342,090 B2 *	7/2019	Noeldner	H05B 47/105
10,563,425 B2 *	2/2020	Lunday	E05B 1/003

- (**) Term: **15 Years**
- (21) Appl. No.: **29/728,826**

- (22) Filed: **Mar. 20, 2020**
- (51) **LOC (13) Cl.** **08-06**
- (52) **U.S. Cl.**
USPC **D8/302; D8/331**
- (58) **Field of Classification Search**
USPC D8/330, 331, 338, 341, 301, 302, 307,
D8/312
CPC E05B 1/00; E05B 1/0015; E05B 5/006;
E05B 47/00; E05B 47/0001; E05C 1/002;
E05C 1/004; E05C 1/08; E05C 3/002;
E05C 3/004; E05C 3/006; E05C 3/008;
E05C 3/12
See application file for complete search history.

* cited by examiner

Primary Examiner — Doris Clark

(57) **CLAIM**

The ornamental design for a door lock, as shown and described.

DESCRIPTION

FIG. 1 is a perspective view of a door lock showing my new design;
 FIG. 2 is another perspective view thereof;
 FIG. 3 is a front elevational view thereof;
 FIG. 4 is a rear elevational view thereof;
 FIG. 5 is a left side elevational view thereof;
 FIG. 6 is a right side elevational view thereof;
 FIG. 7 is a top plan view thereof; and,
 FIG. 8 is a bottom plan view thereof.
 The broken lines in the drawings depict boundaries of the door lock that form no part of the claimed design.

(56) **References Cited**

U.S. PATENT DOCUMENTS

D297,807 S *	9/1988	Fildan	D8/300
D391,143 S *	2/1998	Jancsek	D8/306
D554,196 S *	10/2007	Luo	D8/338
D578,374 S *	10/2008	Kim	D8/302
D691,448 S *	10/2013	Weathersby	D8/301

1 Claim, 8 Drawing Sheets

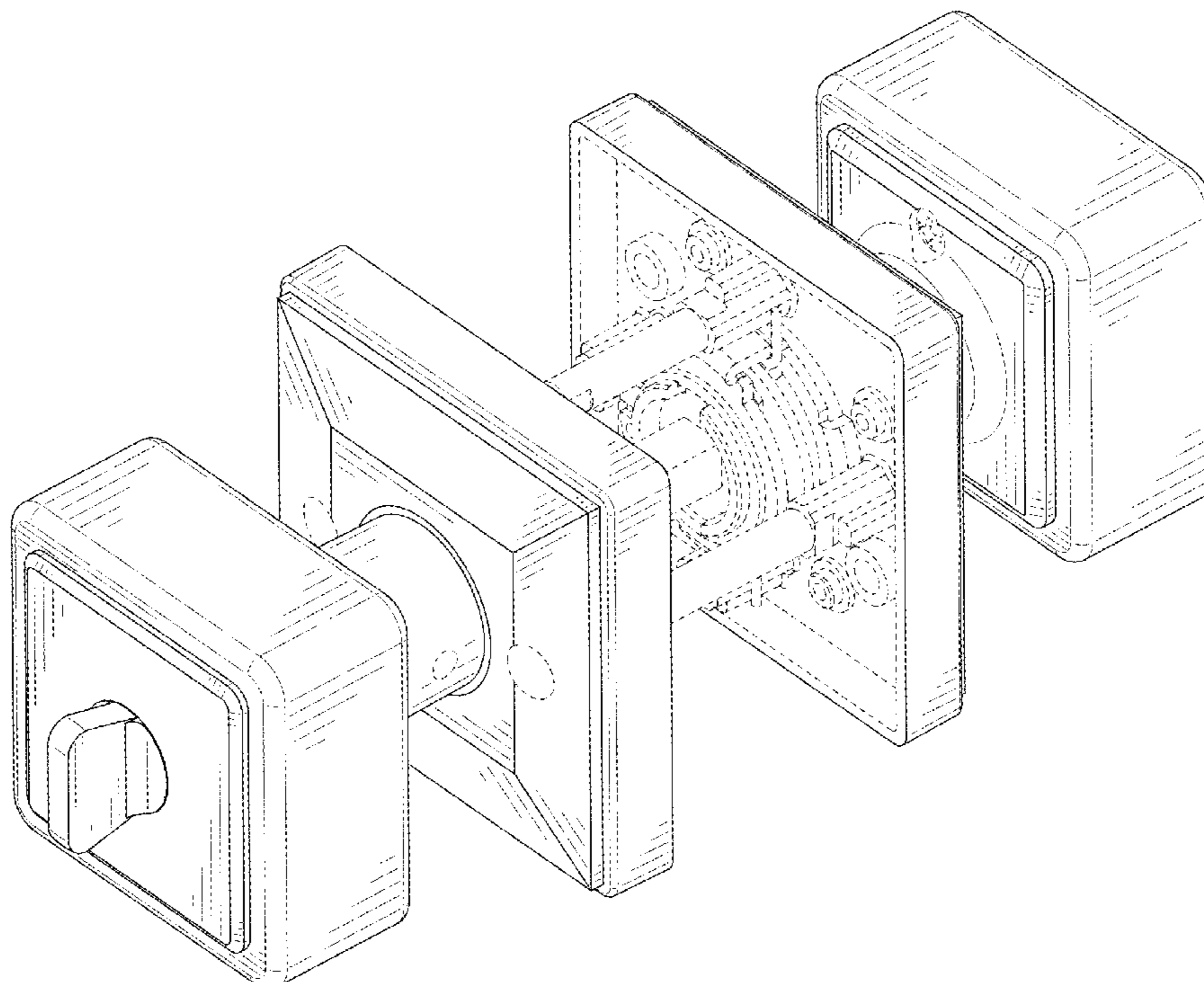

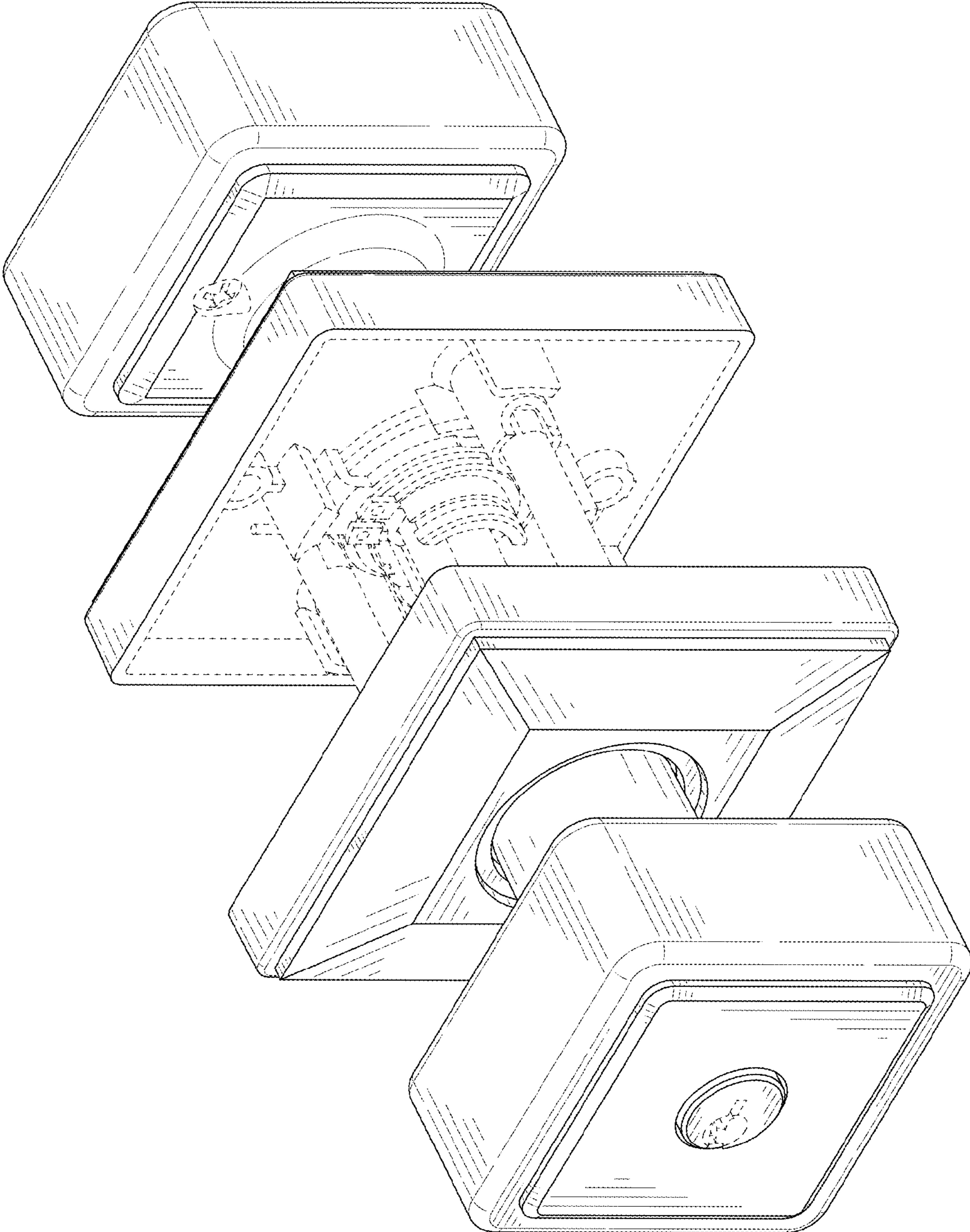

FIG. 1

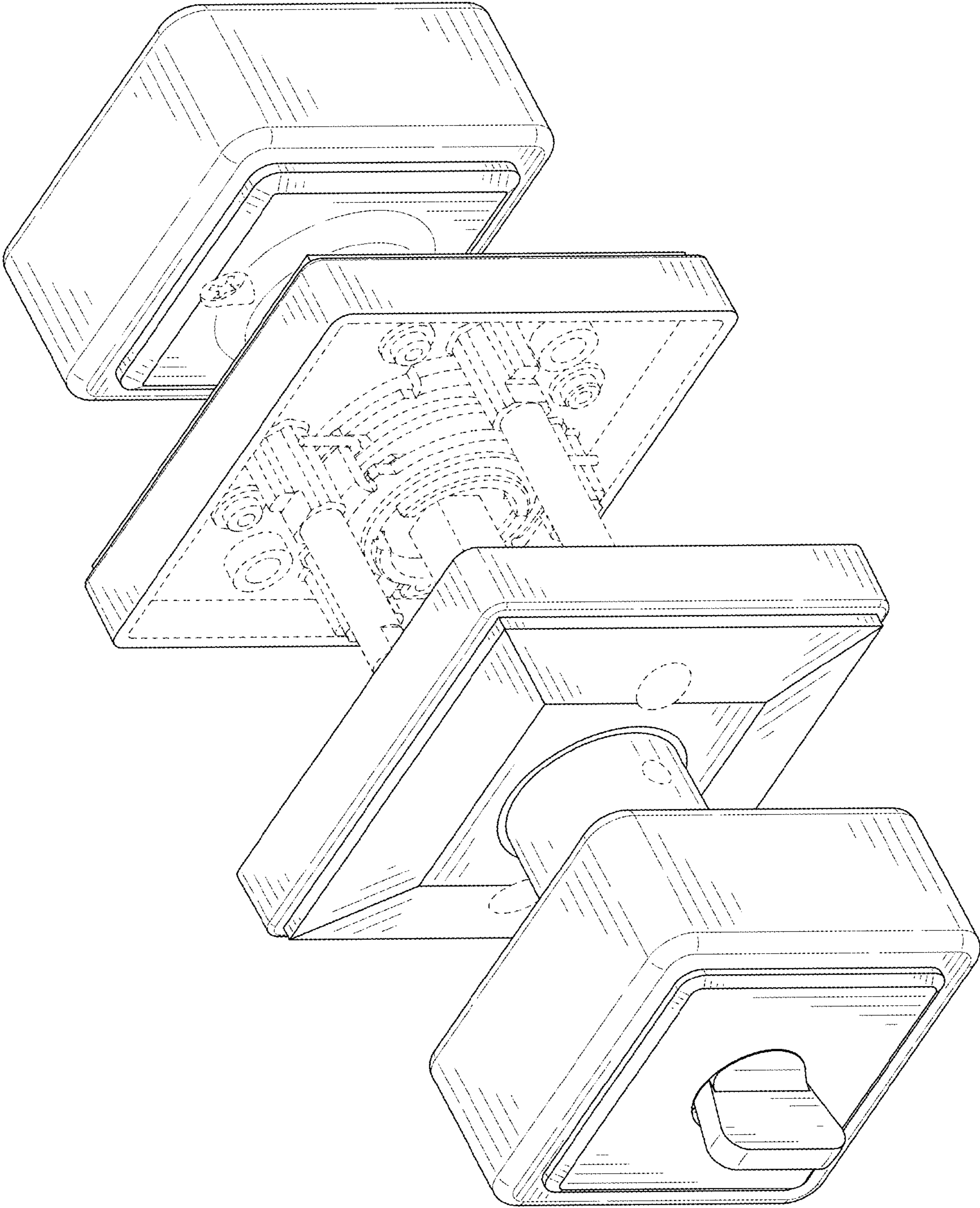

FIG. 2

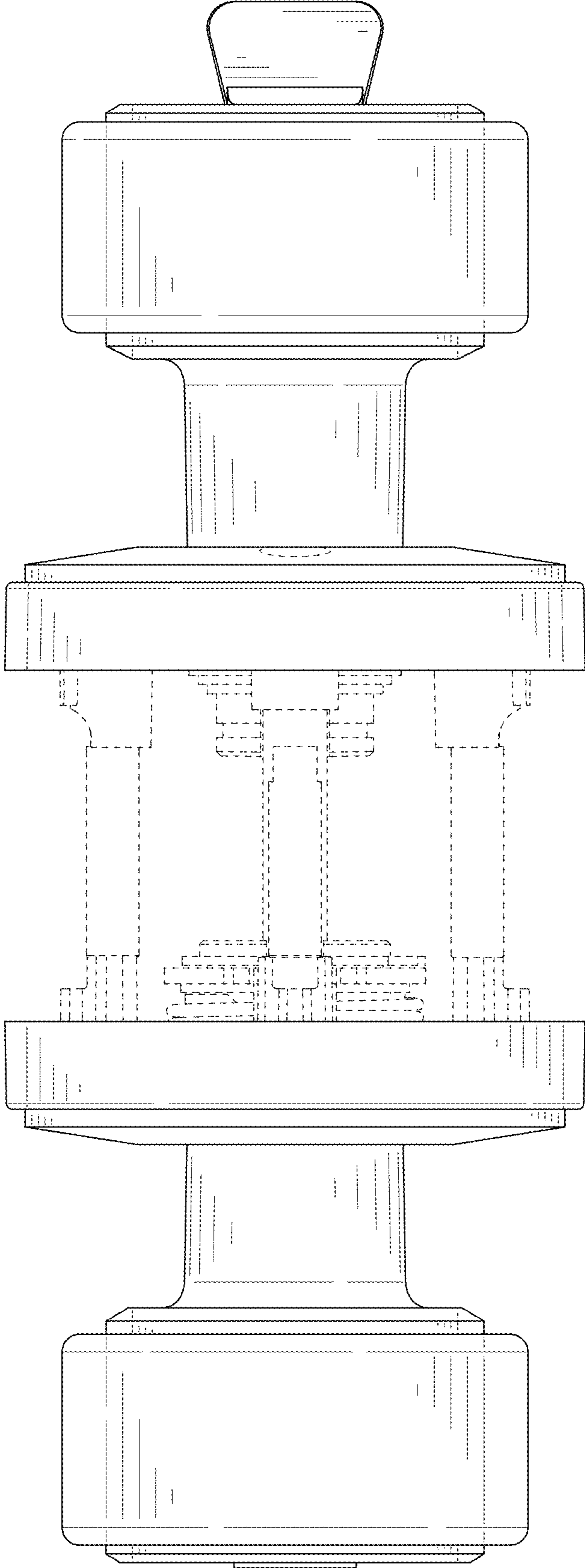

FIG. 3

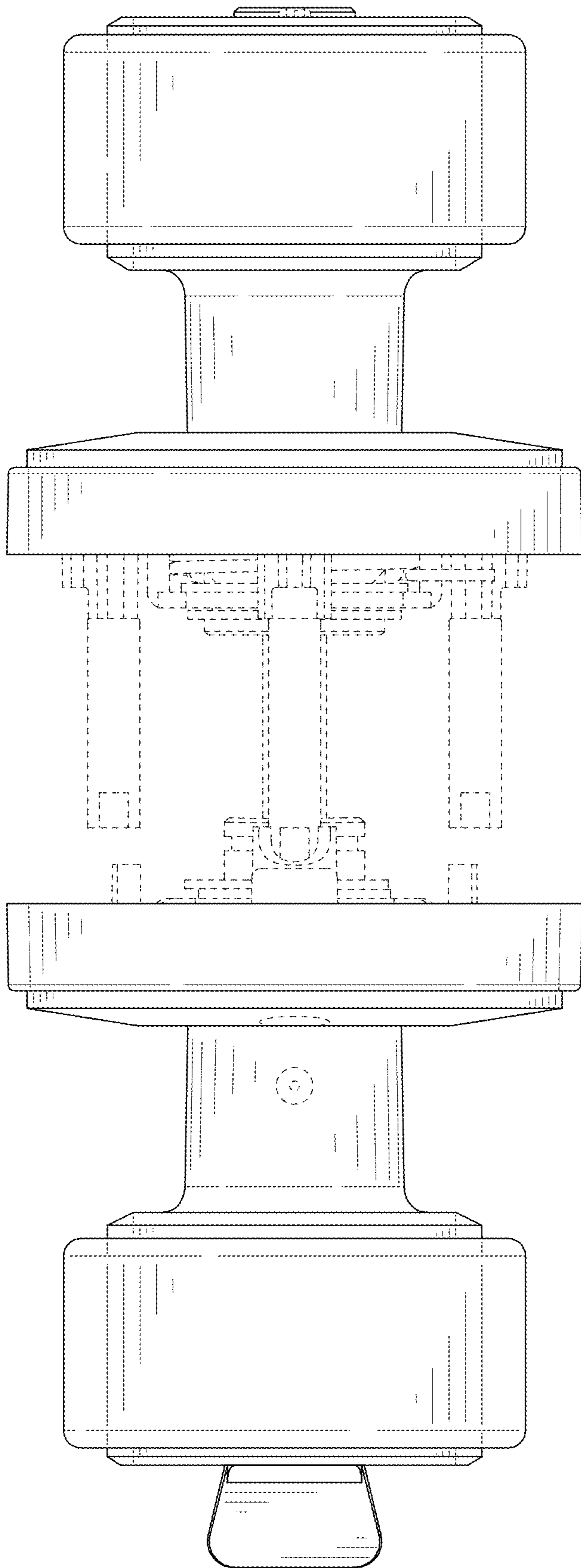

FIG. 4

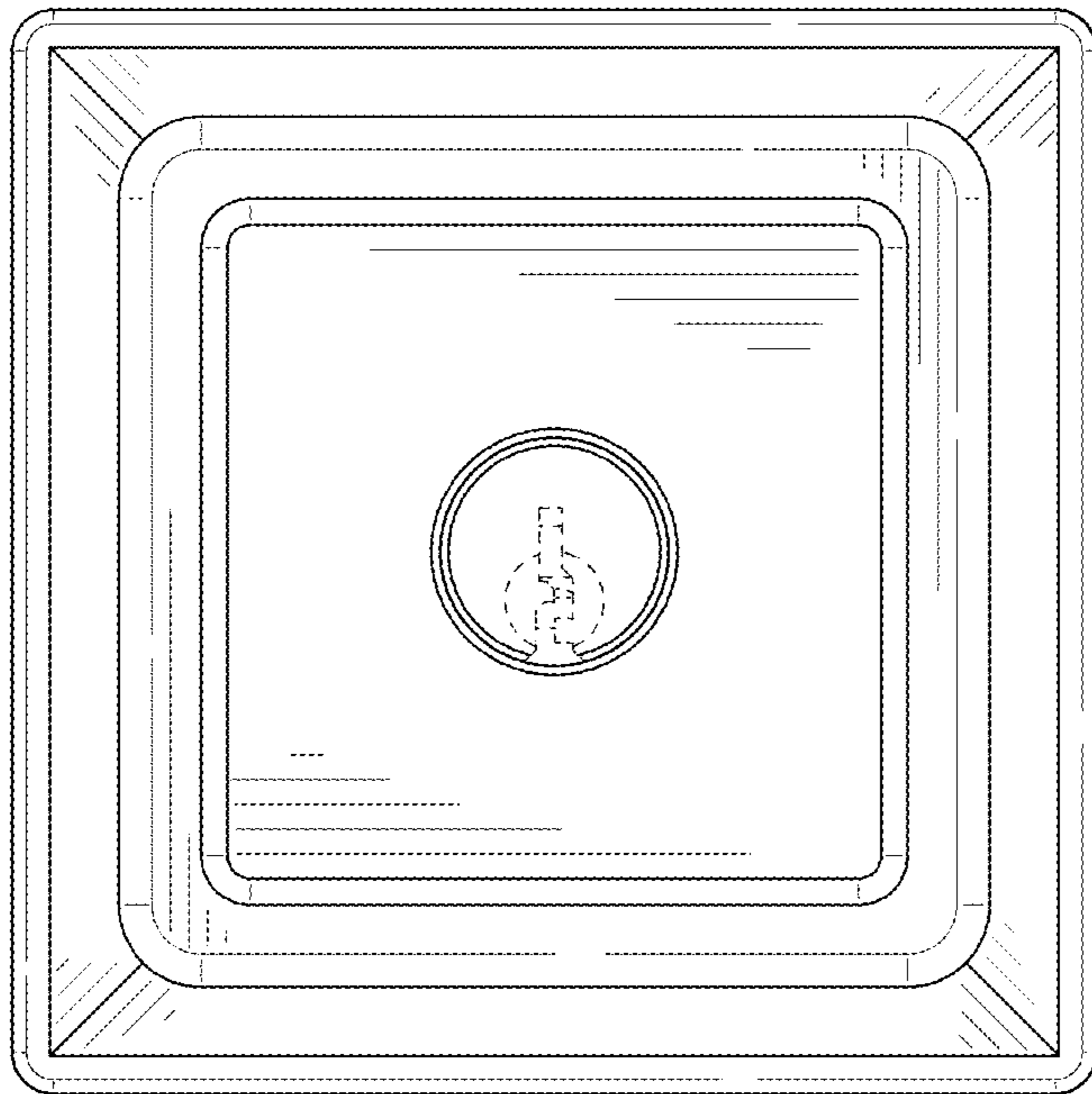

FIG. 5

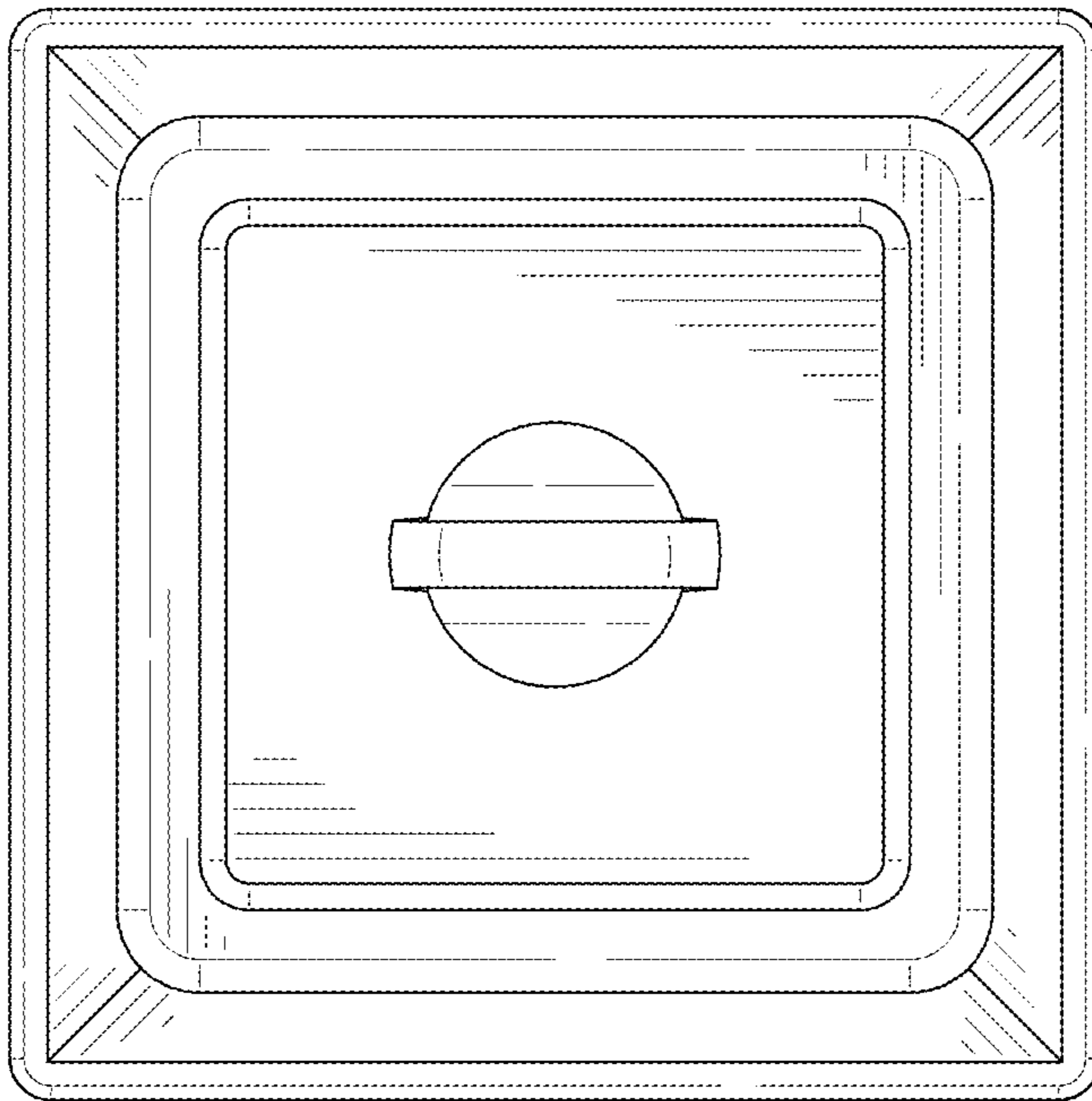

FIG. 6

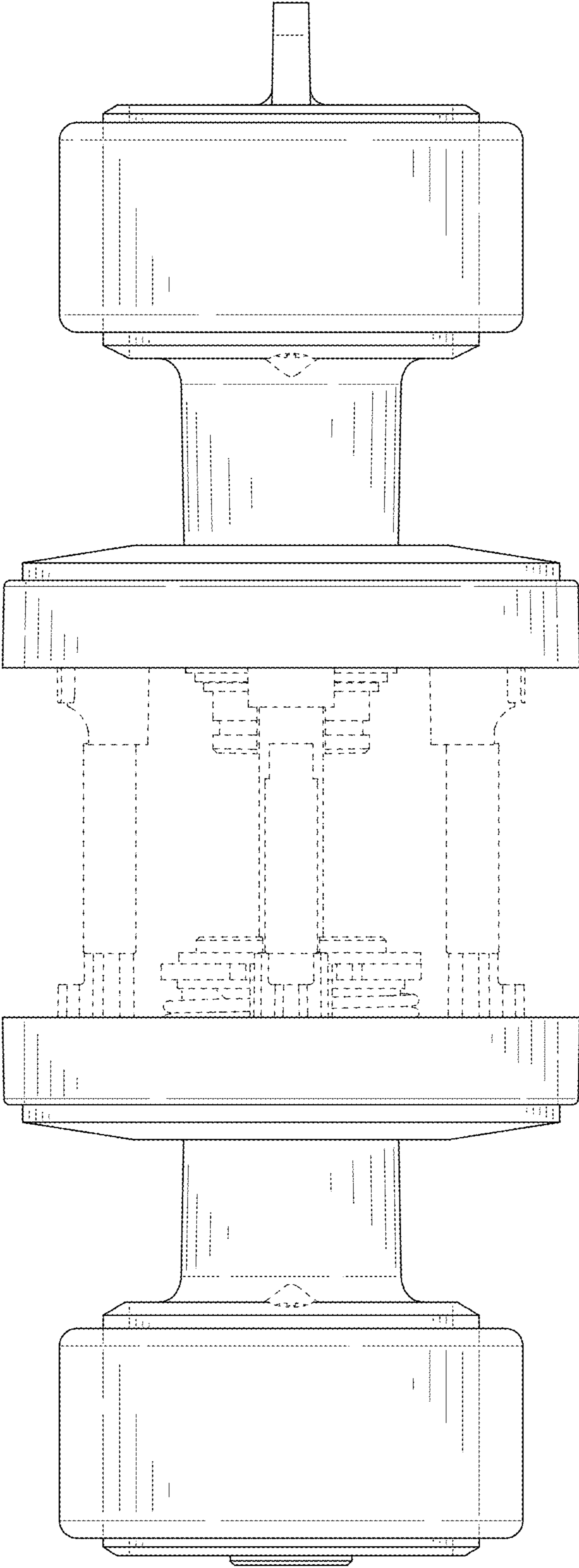

FIG. 7

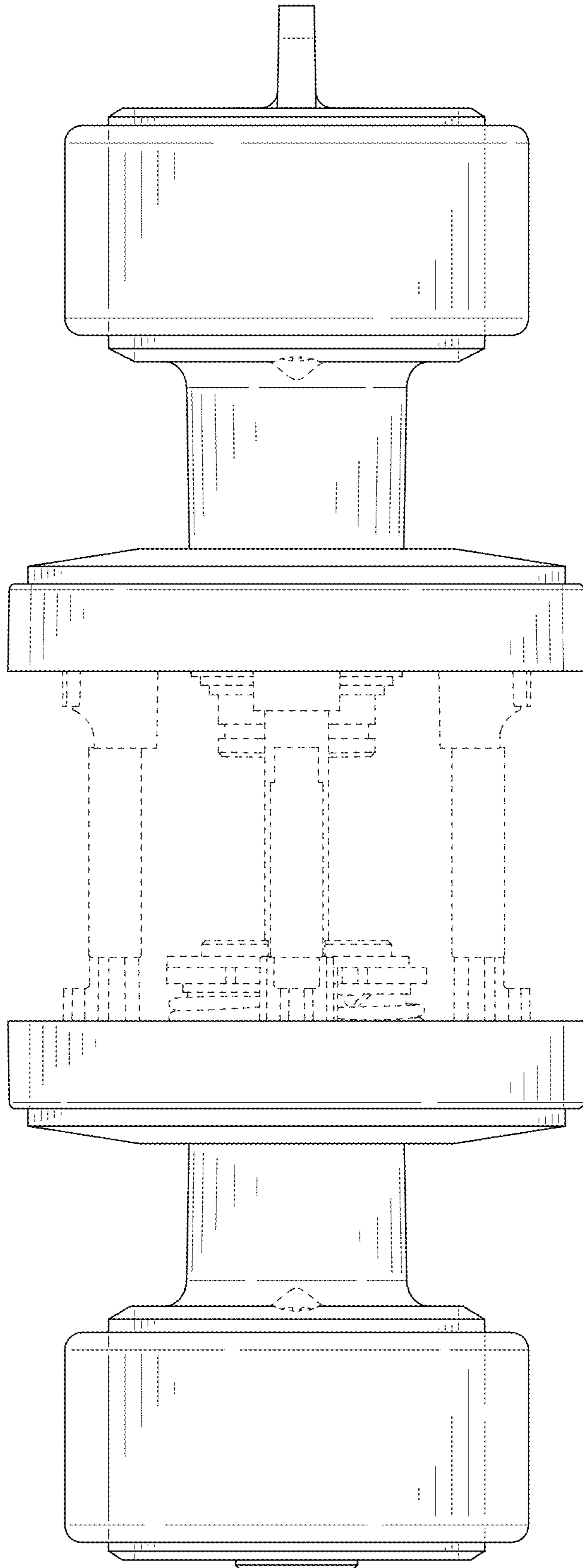

FIG. 8