



US00D922826S

(12) **United States Design Patent**  
**Lin**

(10) **Patent No.:** **US D922,826 S**

(45) **Date of Patent:** **\*\* Jun. 22, 2021**

(54) **WATER BOTTLE**

(71) Applicant: **HUMBOLDT TECHNOLOGY (HK) LIMITED, KI (HK)**

(72) Inventor: **Wuqiang Lin, Shenzhen (CN)**

(\*\*) Term: **15 Years**

(21) Appl. No.: **29/756,041**

(22) Filed: **Oct. 26, 2020**

(51) **LOC (13) Cl.** ..... **07-01**

(52) **U.S. Cl.**

USPC ..... **D7/510; D7/511; D7/536**

(58) **Field of Classification Search**

USPC ..... D7/507, 509, 510, 511, 387, 392.1,  
D7/396.2, 368, 690, 376, 300.1, 300.2,  
D7/312, 213, 536, 533; D9/435, 436,  
D9/530, 537, 543, 503, 504

CPC ..... A47J 43/27; A47G 19/22; A47G 19/16;  
A47G 19/2205; A47G 19/2288; B65D  
1/265

See application file for complete search history.

(56) **References Cited**

**U.S. PATENT DOCUMENTS**

D772,652 S \* 11/2016 Yao ..... D7/511  
D801,111 S \* 10/2017 Eyal ..... D7/392.1  
D807,110 S \* 1/2018 Lown ..... D7/391  
D838,598 S \* 1/2019 Melkonian ..... D9/531  
D871,845 S \* 1/2020 Huang ..... D7/510  
D873,145 S 1/2020 Hamgeri

D881,647 S \* 4/2020 Wang ..... D7/510  
D903,404 S \* 12/2020 Bram ..... D7/392.1  
D913,036 S \* 3/2021 Steenari ..... D7/392.1

**OTHER PUBLICATIONS**

[https://www.amazon.com/Letsfit-Motivational-Reminder-Capacity-Leakproof/dp/B08VJ9W19H/ref=sr\\_1\\_10?dchild=1&keywords=jug%2Bwater%2Bbottle&qid=1618839507&sr=8-10&th=1](https://www.amazon.com/Letsfit-Motivational-Reminder-Capacity-Leakproof/dp/B08VJ9W19H/ref=sr_1_10?dchild=1&keywords=jug%2Bwater%2Bbottle&qid=1618839507&sr=8-10&th=1) (Year: 2021).\*

\* cited by examiner

*Primary Examiner* — Jae Liang

(57) **CLAIM**

The ornamental design for a water bottle, as shown and described.

**DESCRIPTION**

FIG. 1 is a front and top perspective view of a water bottle, showing my new design;  
FIG. 2 is a rear and bottom perspective view thereof;  
FIG. 3 is a front elevational view thereof;  
FIG. 4 is a rear elevational view thereof;  
FIG. 5 is a left side elevational view thereof;  
FIG. 6 is a right side elevational view thereof;  
FIG. 7 is a top plan view thereof; and,  
FIG. 8 is a bottom plan view thereof.

**1 Claim, 8 Drawing Sheets**

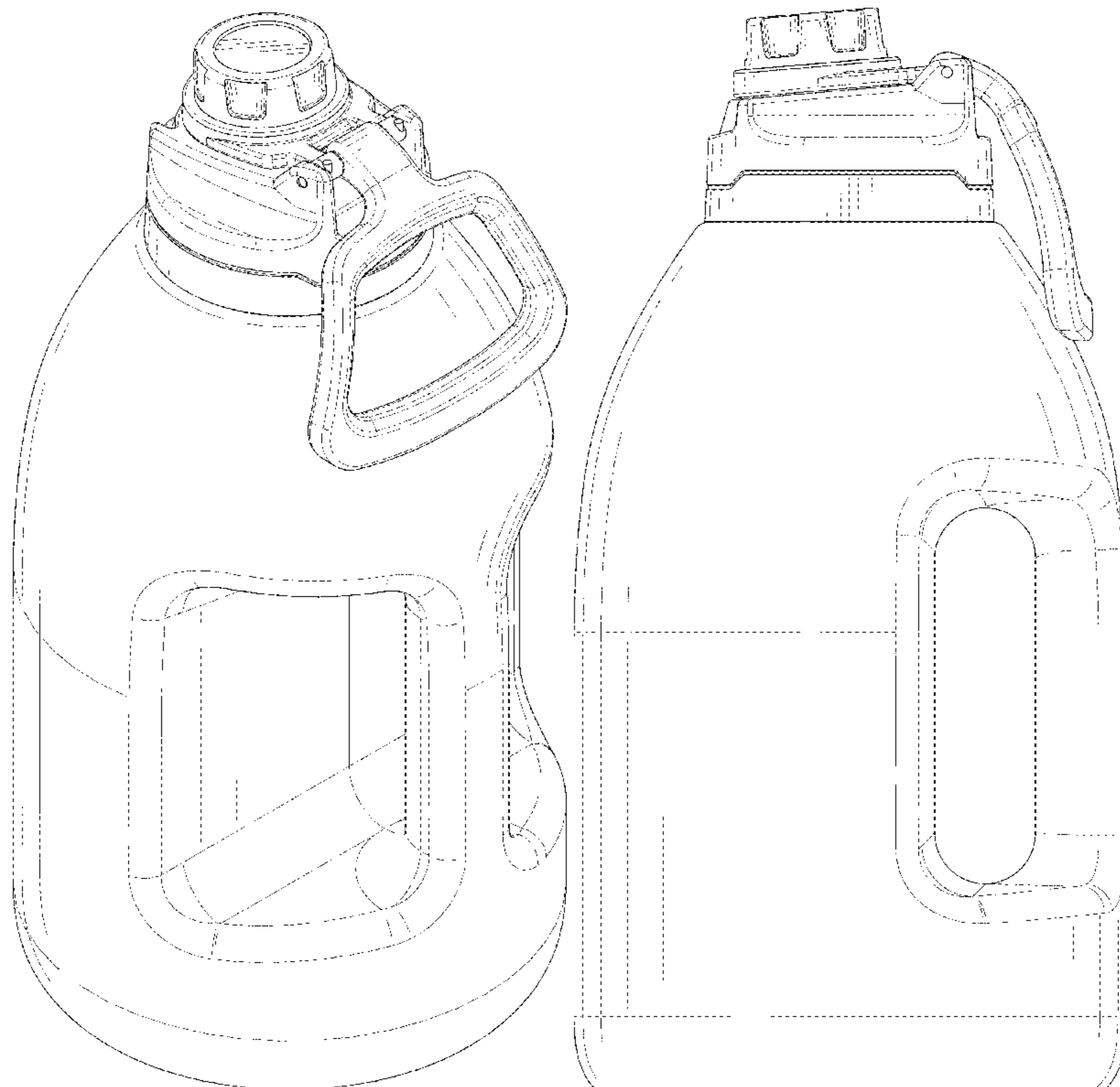

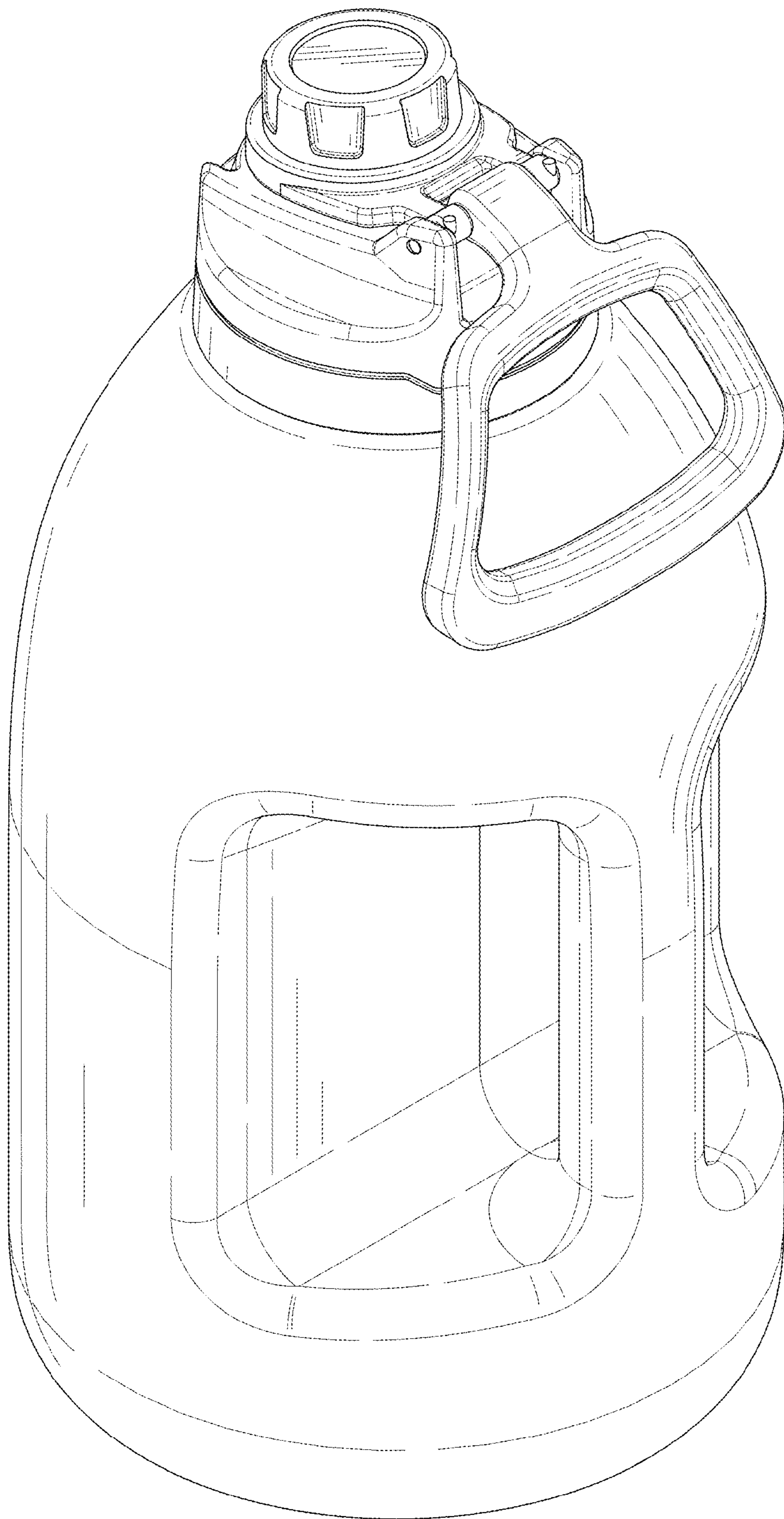

FIG. 1

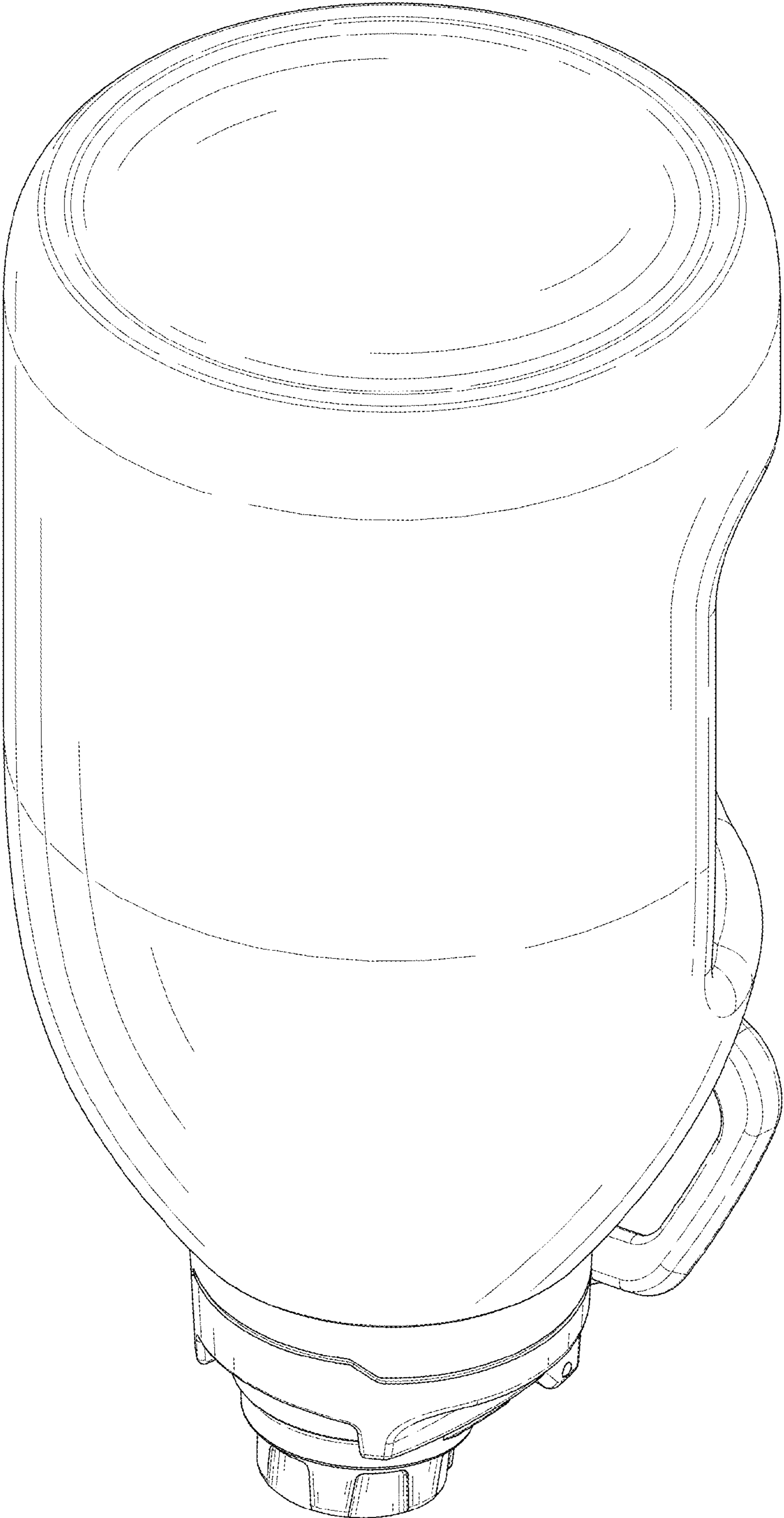

FIG. 2

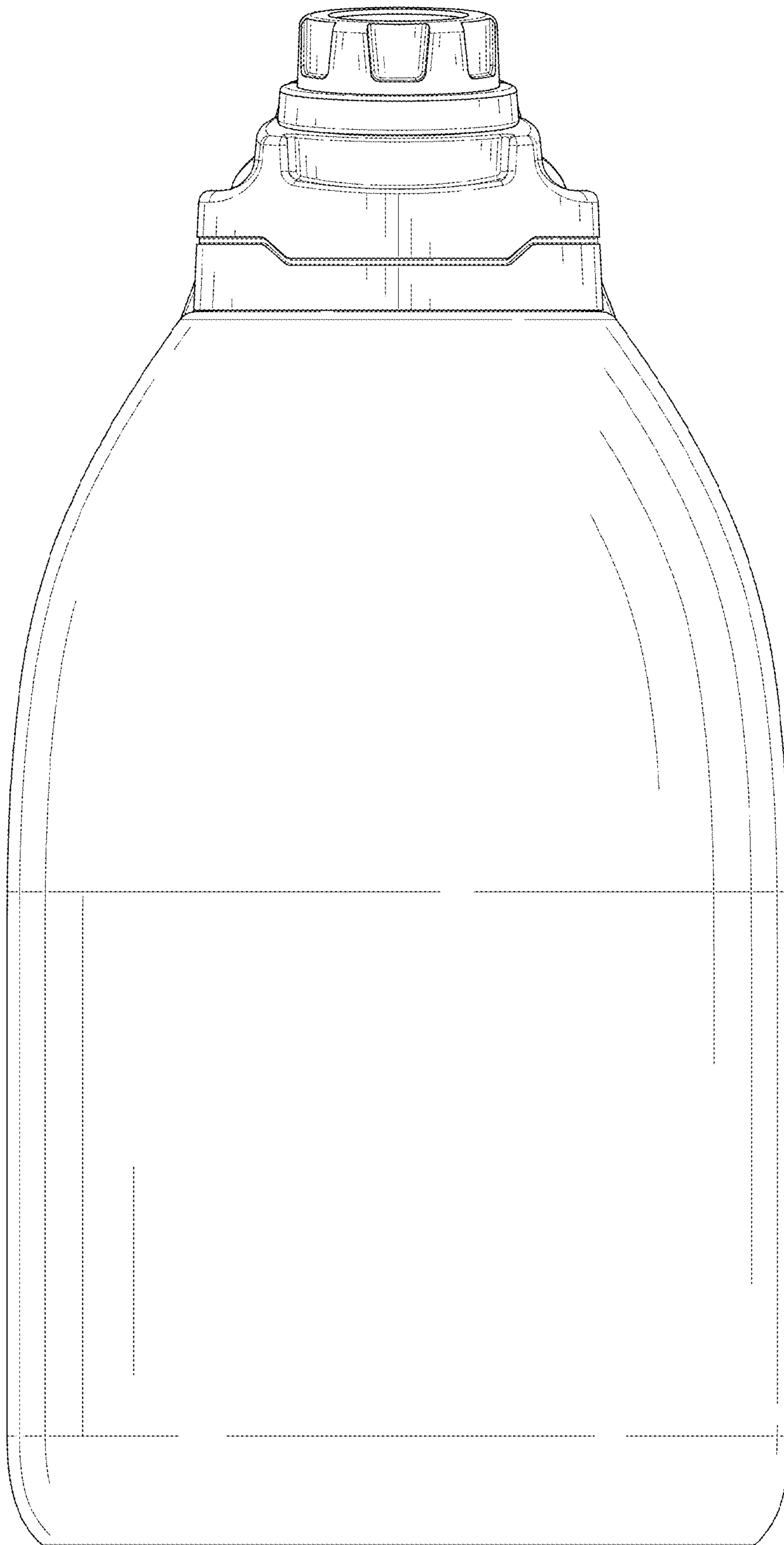

FIG. 3

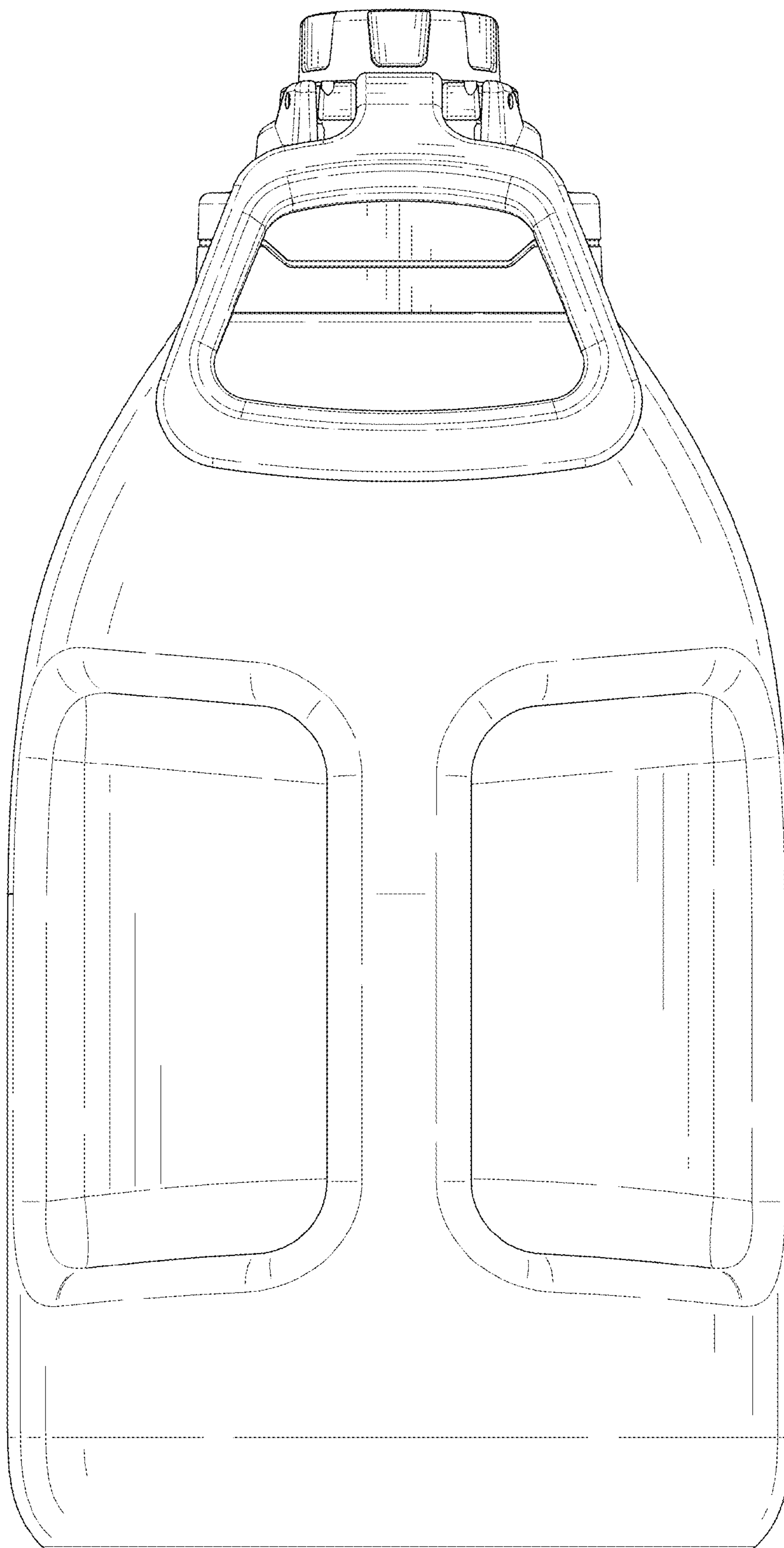

FIG. 4

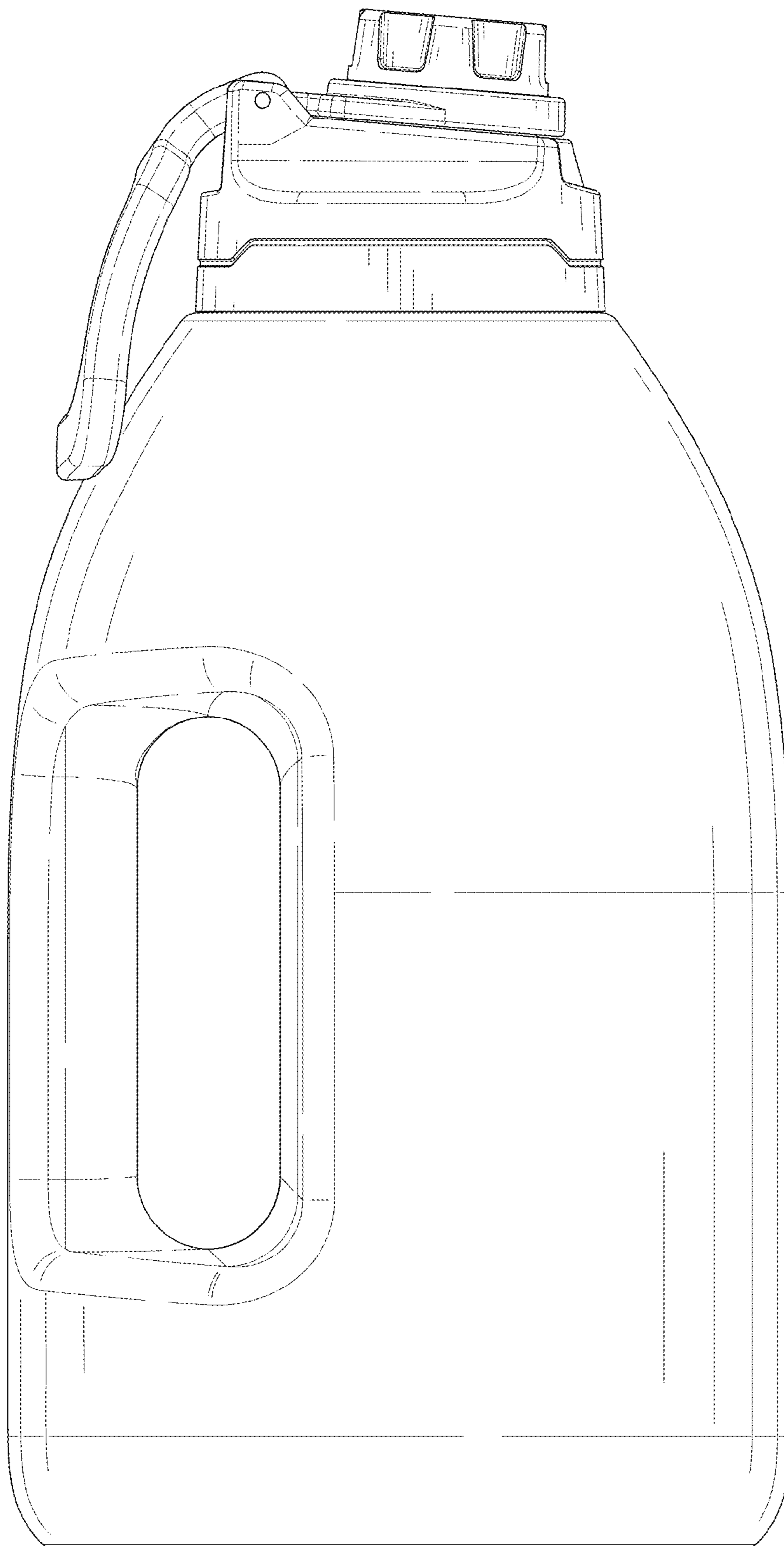

FIG. 5

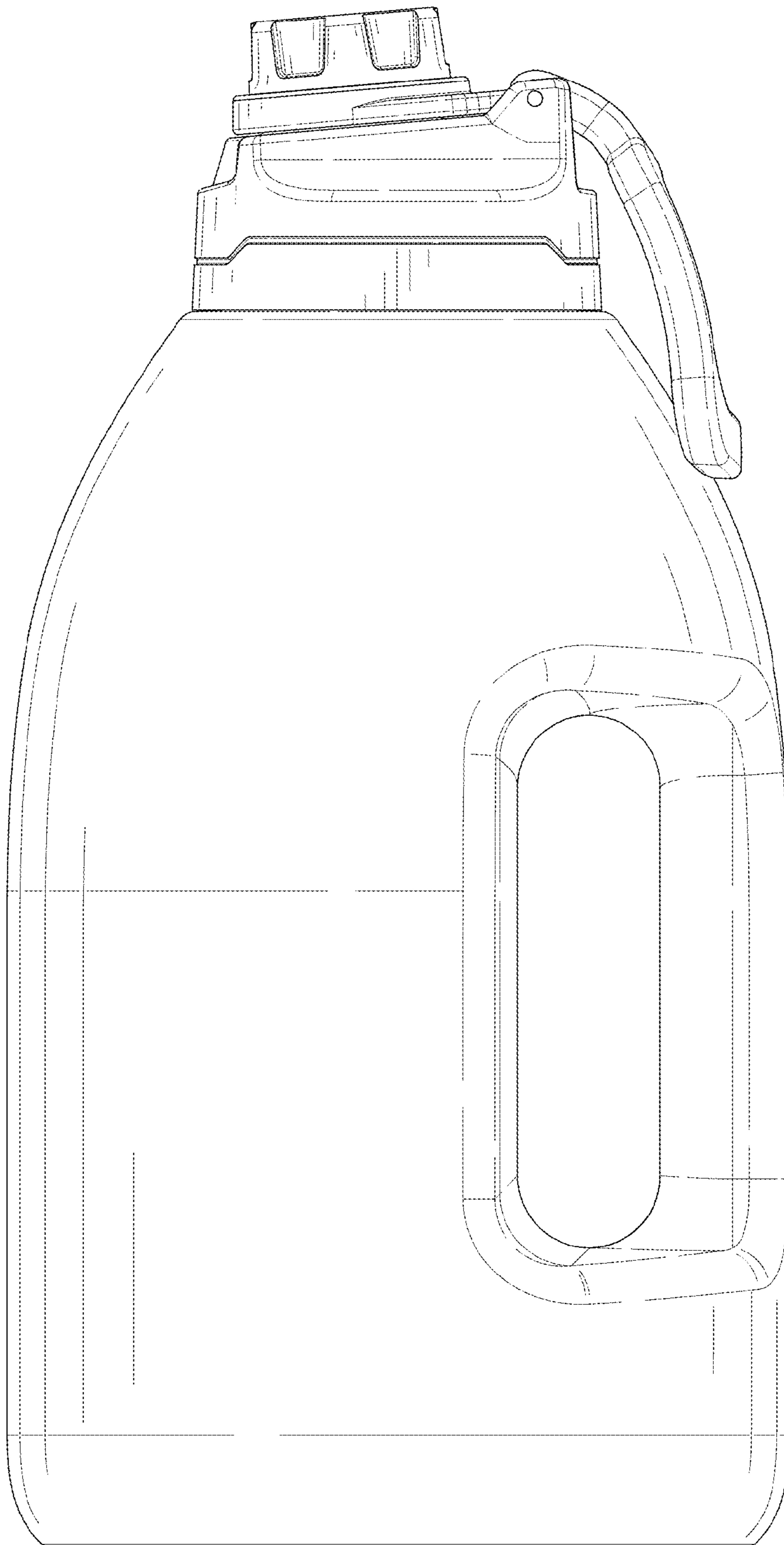

FIG. 6

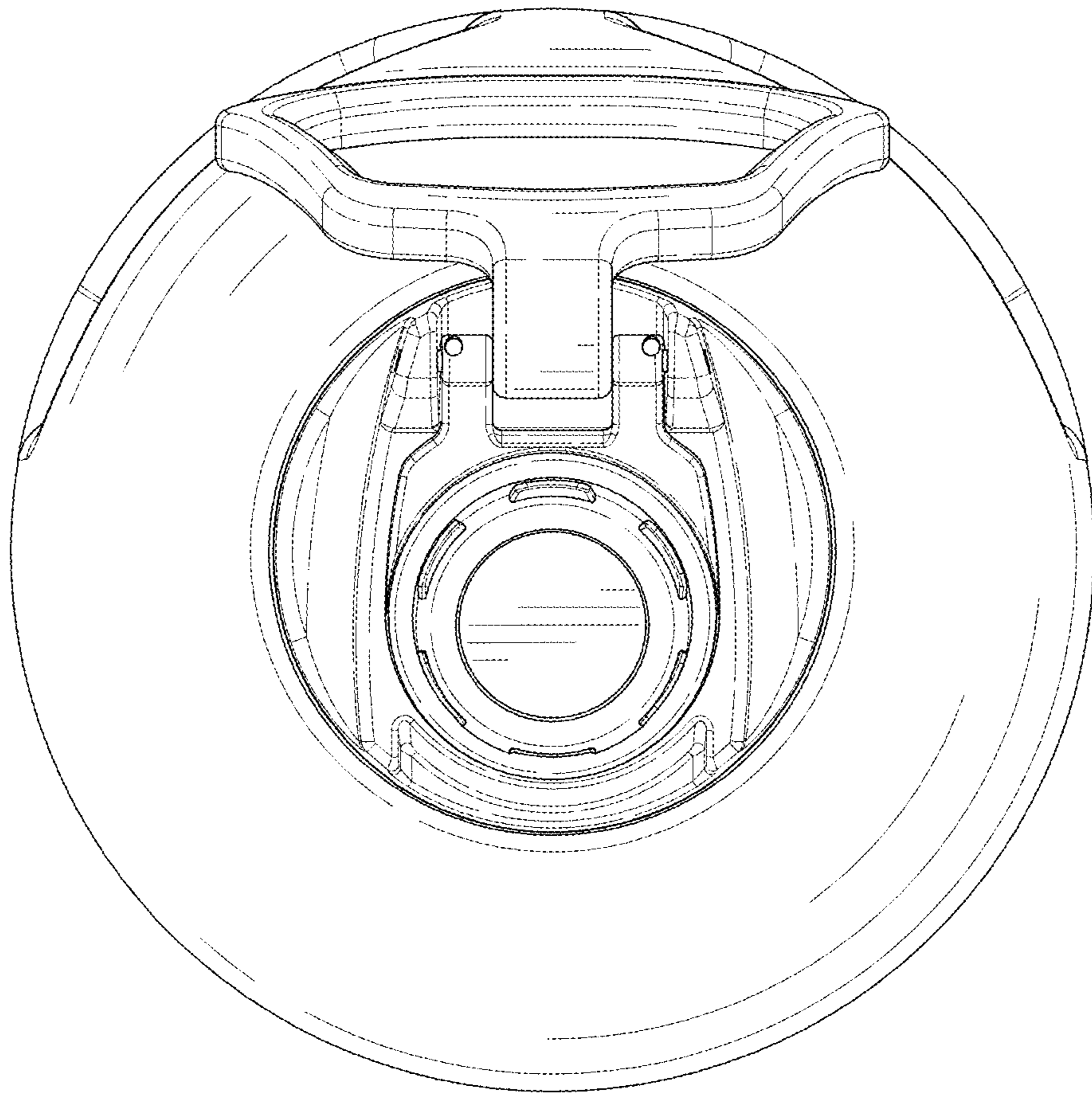

FIG. 7



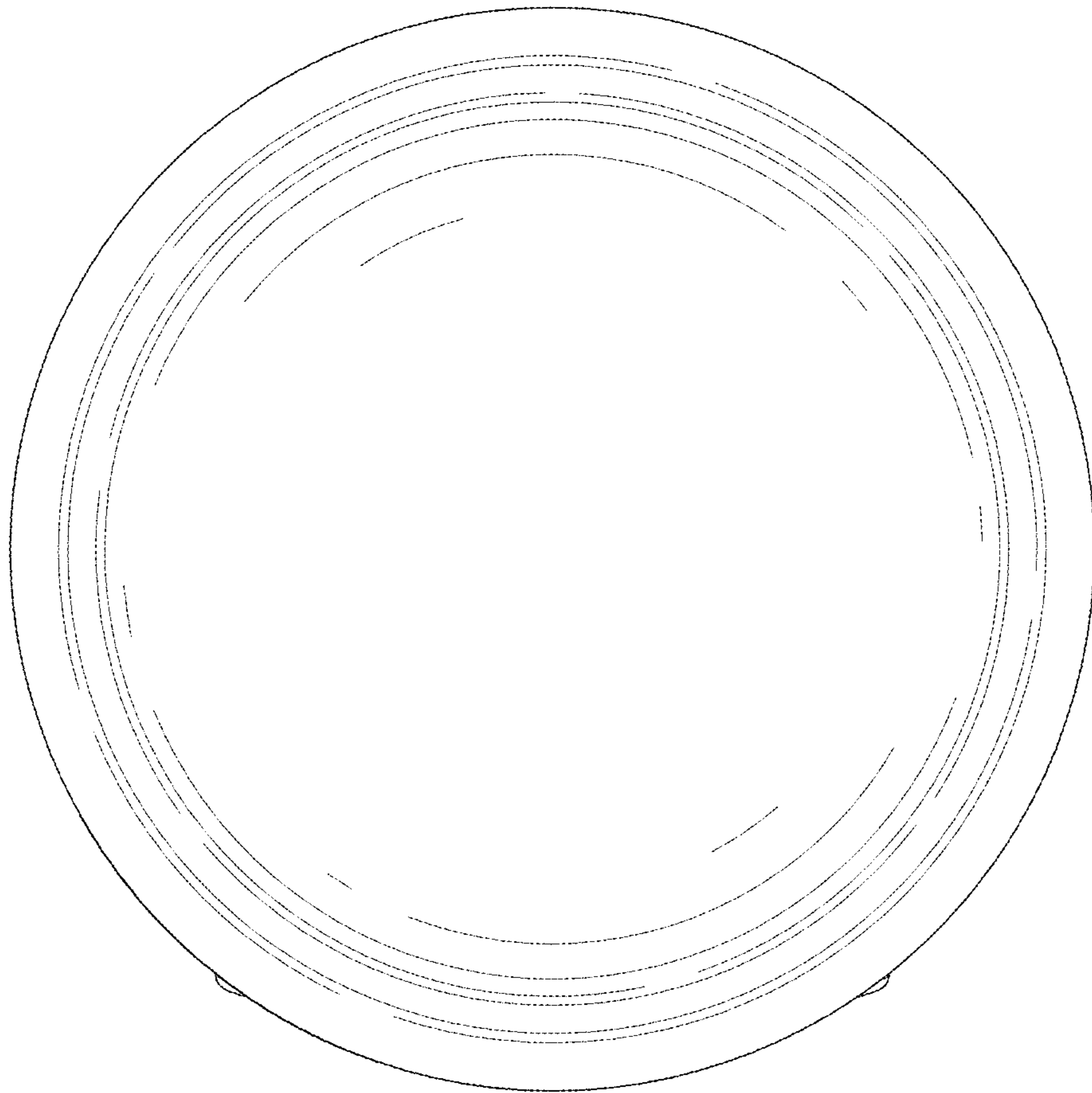

FIG. 8