



US00D922715S

(12) **United States Design Patent**
Li

(10) **Patent No.:** **US D922,715 S**

(45) **Date of Patent:** **** Jun. 15, 2021**

(54) **OVER-SINK RETRACTABLE DISH DRYING RACK**

(71) Applicant: **DONGGUAN HUIQICHENG HOUSEHOLD PRODUCTS CO., LTD.**, Dongguan (CN)

(72) Inventor: **Xuewen Li**, Dongguan (CN)

(73) Assignee: **DONGGUAN HUIQICHENG HOUSEHOLD PRODUCTS CO., LTD.**, Dongguan (CN)

(**) Term: **15 Years**

(21) Appl. No.: **29/752,482**

(22) Filed: **Sep. 28, 2020**

(51) **LOC (13) Cl.** **07-05**

(52) **U.S. Cl.**
USPC **D32/55**

(58) **Field of Classification Search**
USPC D32/585, 276, 3; D6/510, 525; D30/133; 211/41.5, 41.4, 41.3, 41.8; 312/311, 333, 334.4; D7/354, 629
CPC .. A47L 15/505; A47L 15/503; A47L 15/0013; A47L 19/02; A47L 19/04; A47J 47/20
See application file for complete search history.

(56) **References Cited**

U.S. PATENT DOCUMENTS

D630,397 S 1/2011 Molayem
D630,813 S * 1/2011 Molayem D32/55

D862,822 S * 10/2019 Zhao D32/55
D862,823 S * 10/2019 Zhao D32/55
D882,199 S * 4/2020 Cao D32/55
D887,098 S * 6/2020 Li D32/55
D903,216 S * 11/2020 Xie D32/55
D915,148 S * 4/2021 Li D7/600.4
D915,708 S * 4/2021 Tang D32/55

* cited by examiner

Primary Examiner — Austin Murphy

(57) **CLAIM**

The ornamental design for an over-sink retractable dish drying rack, as shown and described.

DESCRIPTION

FIG. 1 is a perspective view of an over-sink retractable dish drying rack showing my new design; FIG. 2 is another perspective view thereof; FIG. 3 is a front elevational view thereof; FIG. 4 is a rear elevational view thereof; FIG. 5 is a left side elevational view thereof; FIG. 6 is a right side elevational view thereof; FIG. 7 is a top plan view thereof; FIG. 8 is a bottom plan view thereof; and, FIG. 9 is an enlarged view of portion 9 shown in FIG. 1.

1 Claim, 9 Drawing Sheets

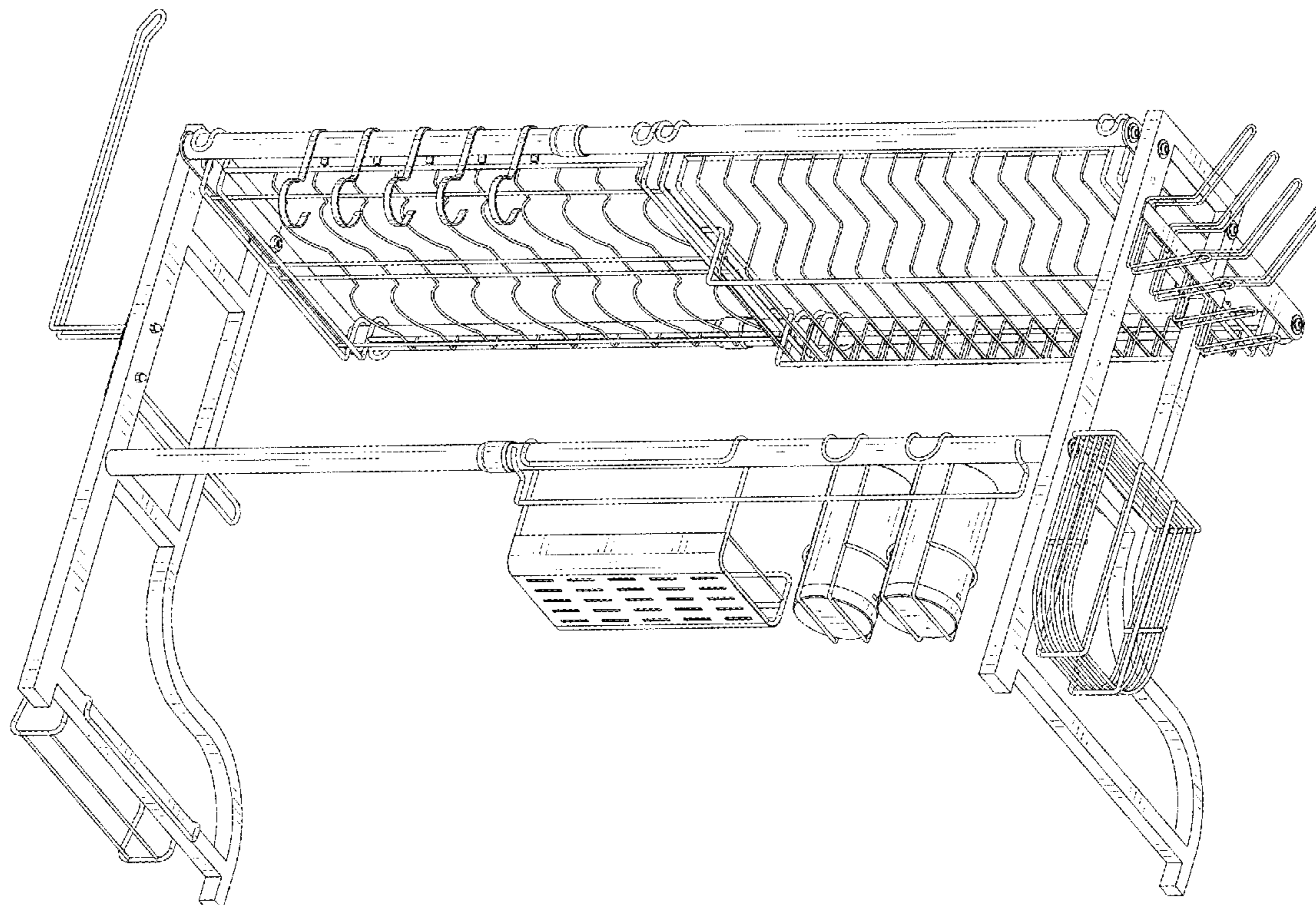

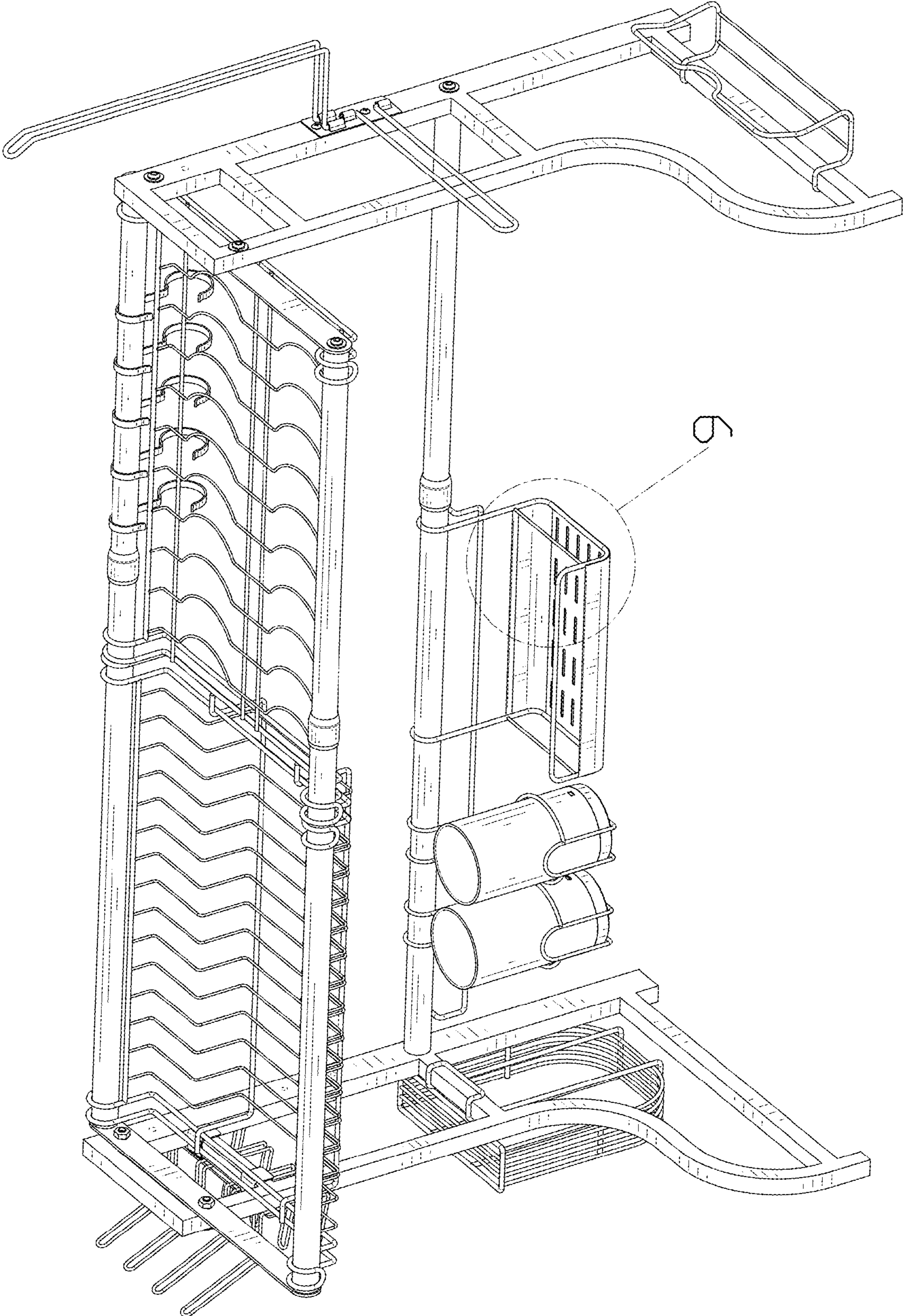

FIG. 1

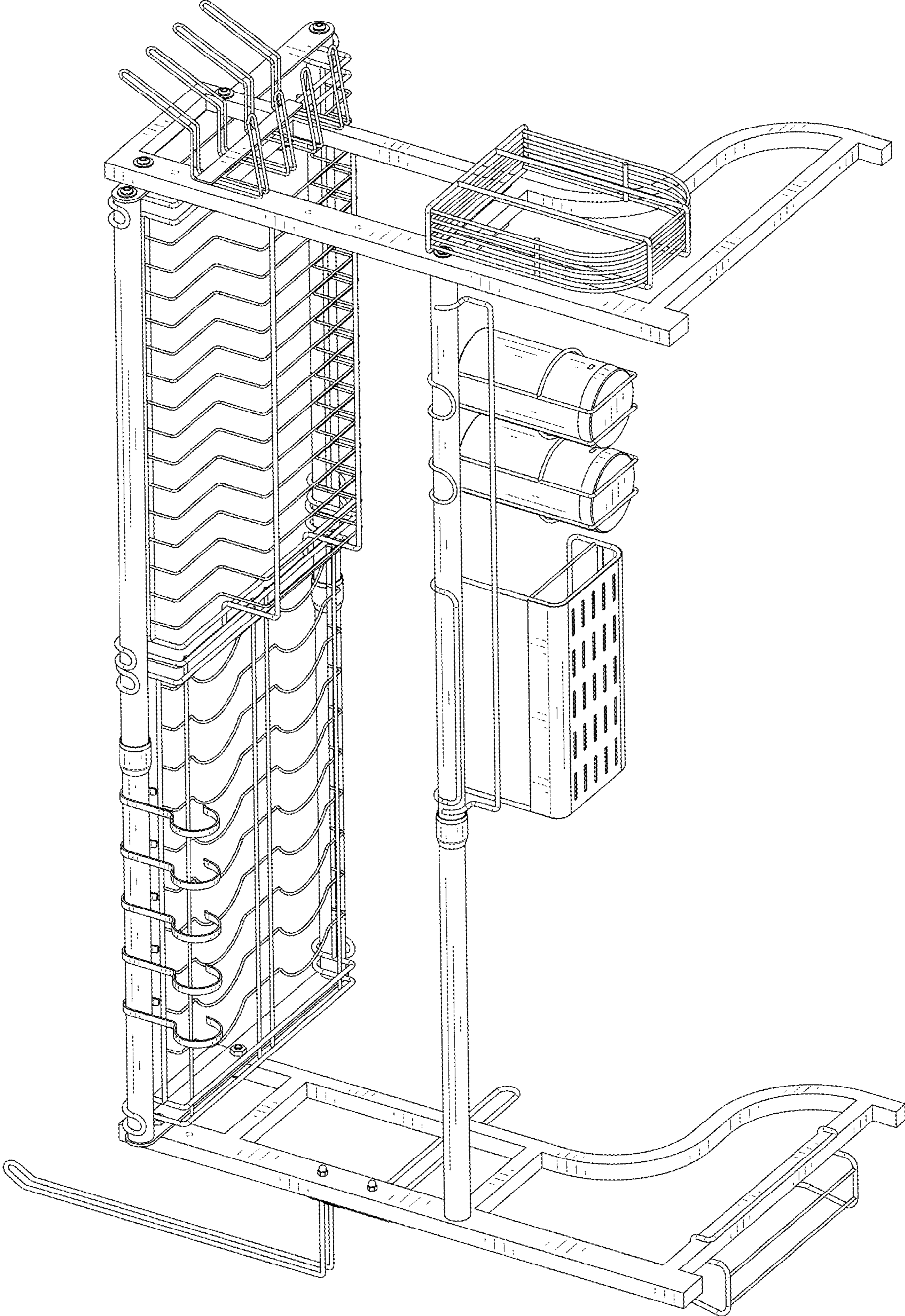

FIG. 2

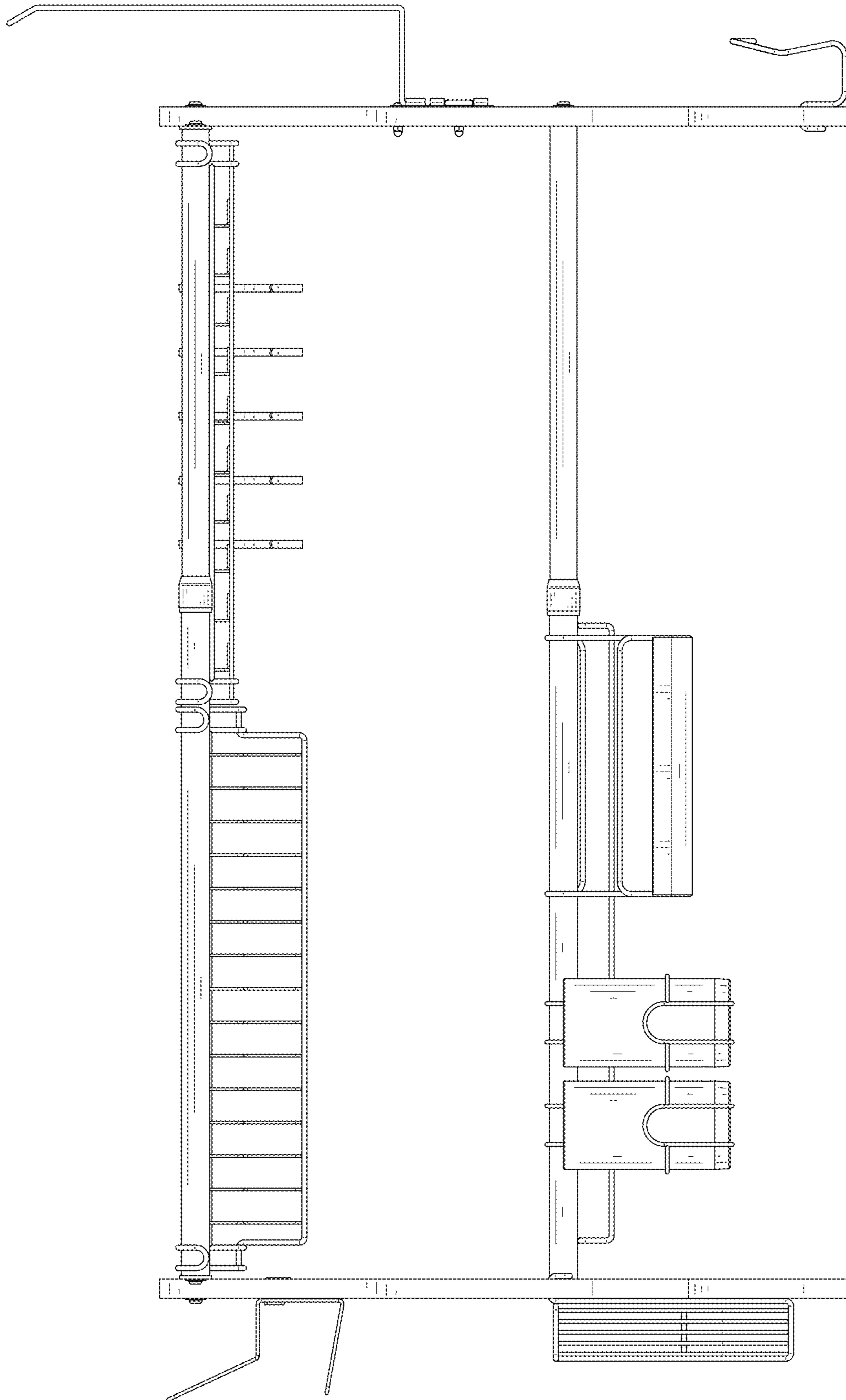

FIG. 3

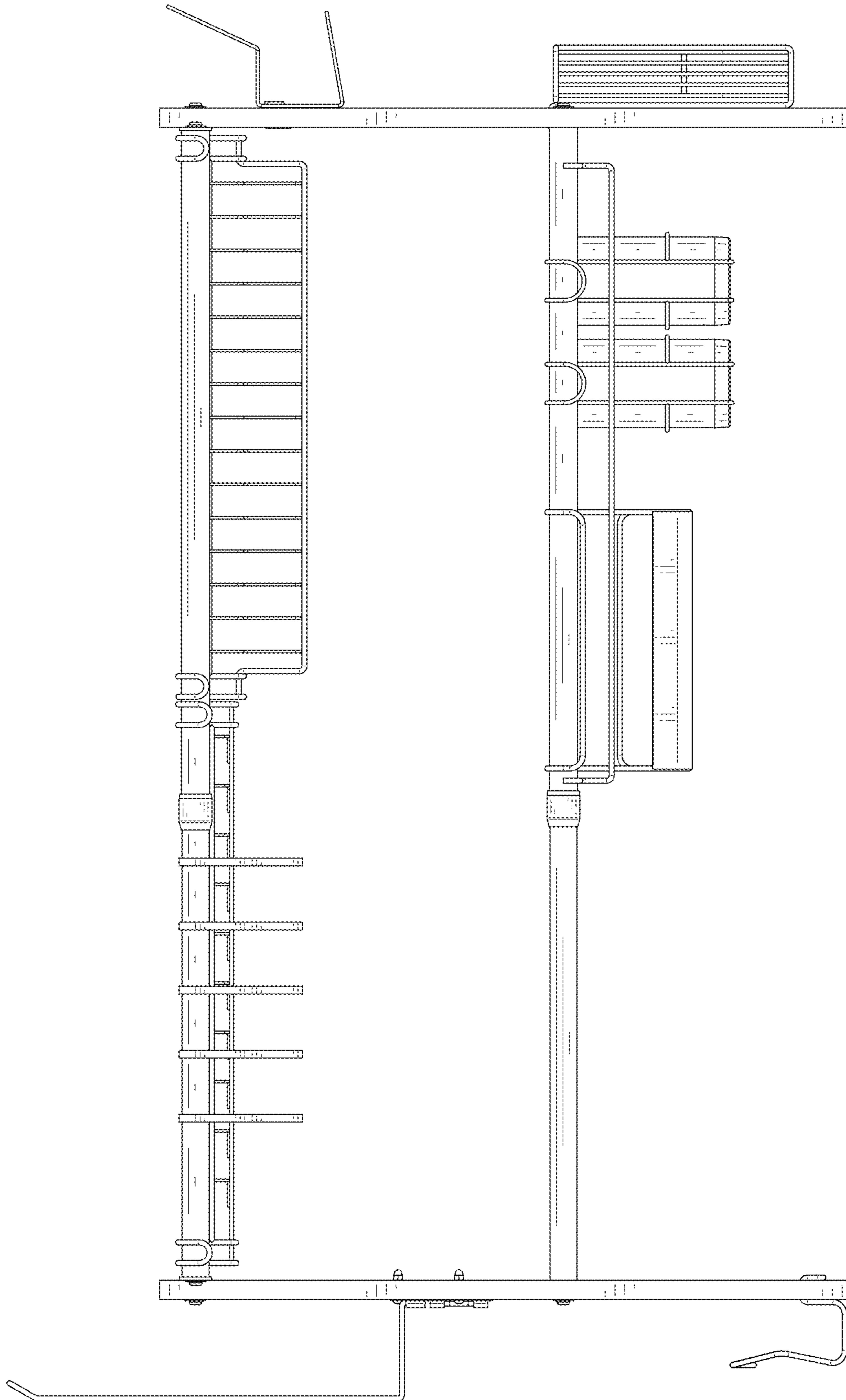

FIG. 4

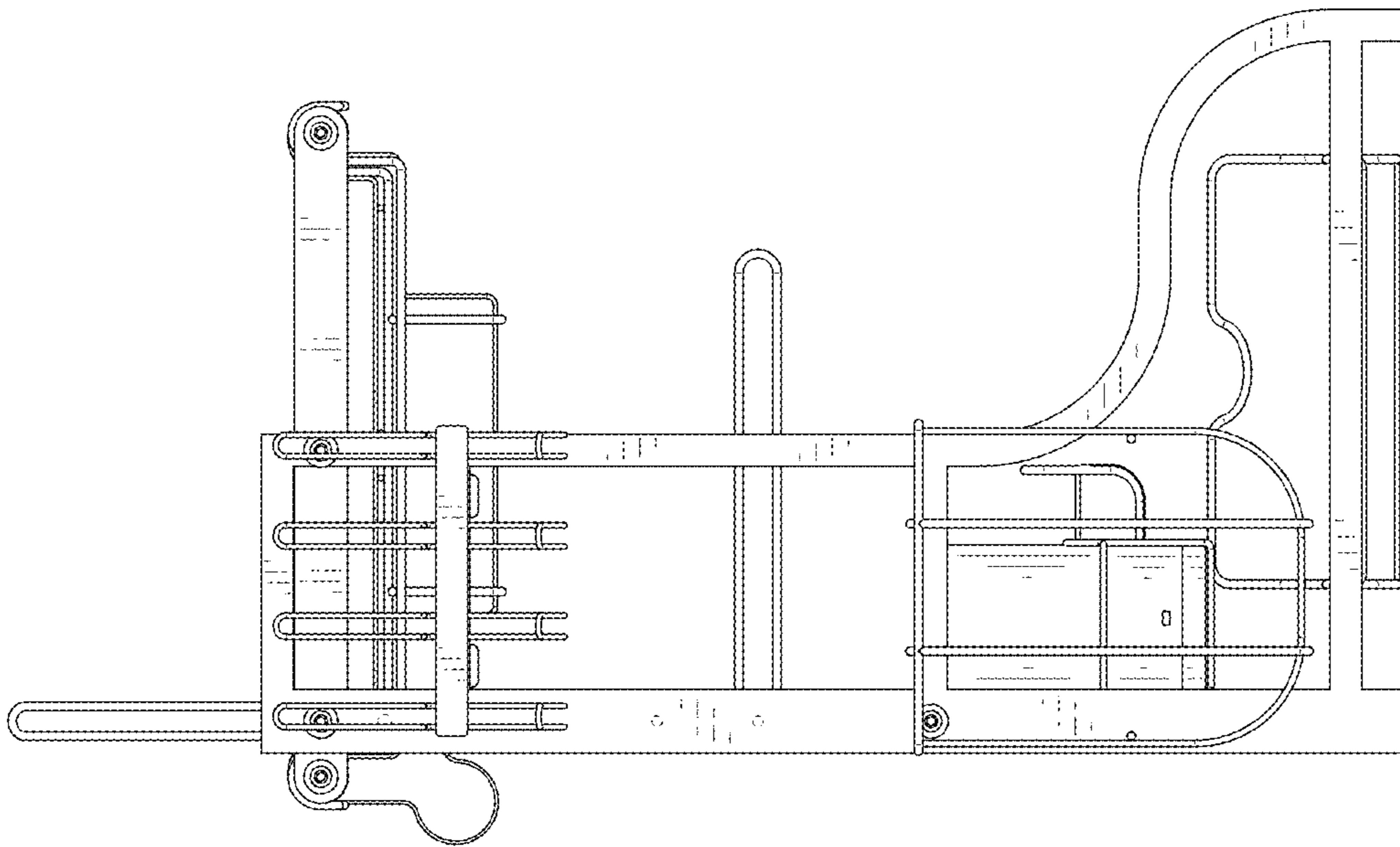

FIG. 5

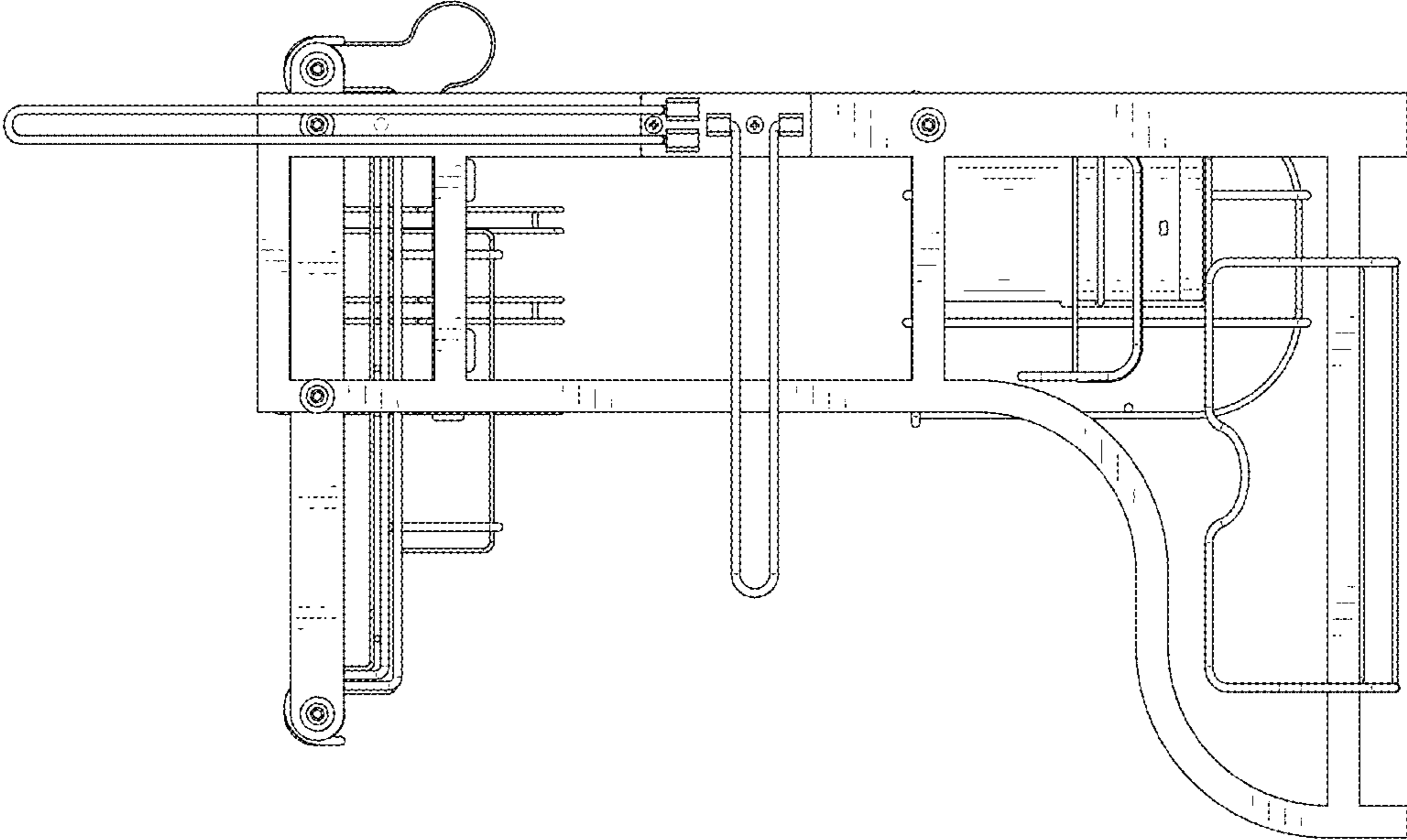

FIG. 6

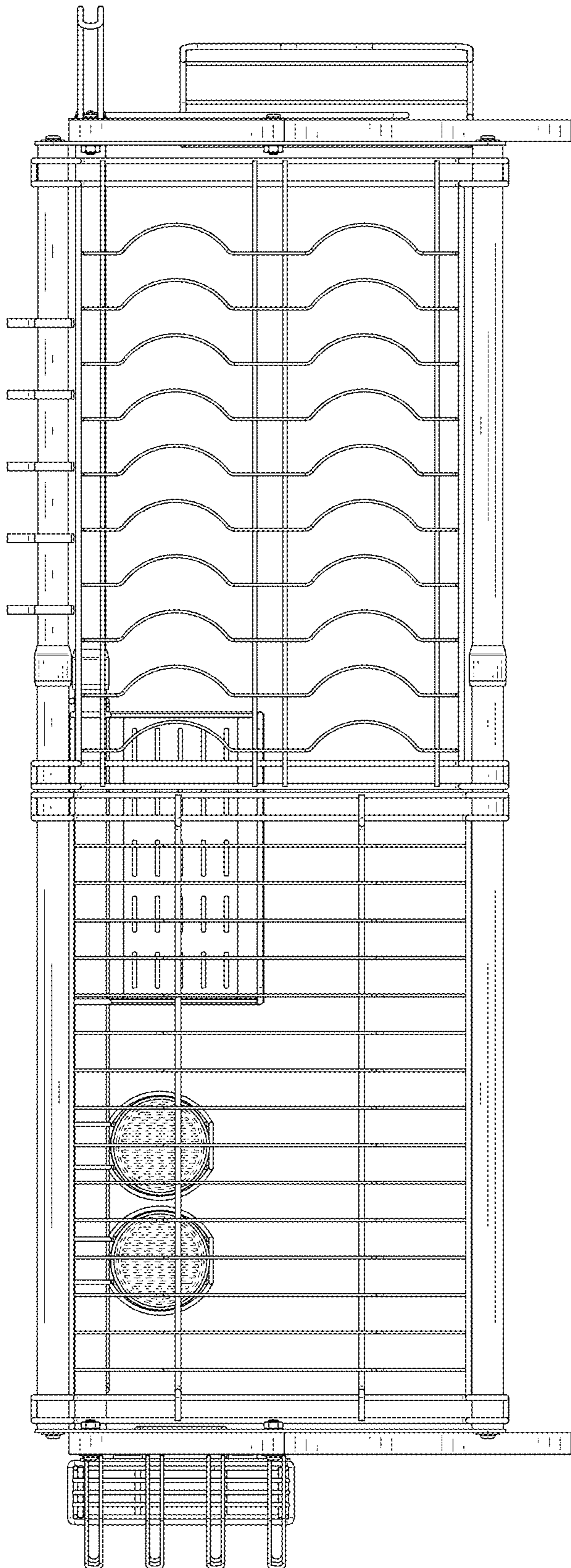

FIG. 7

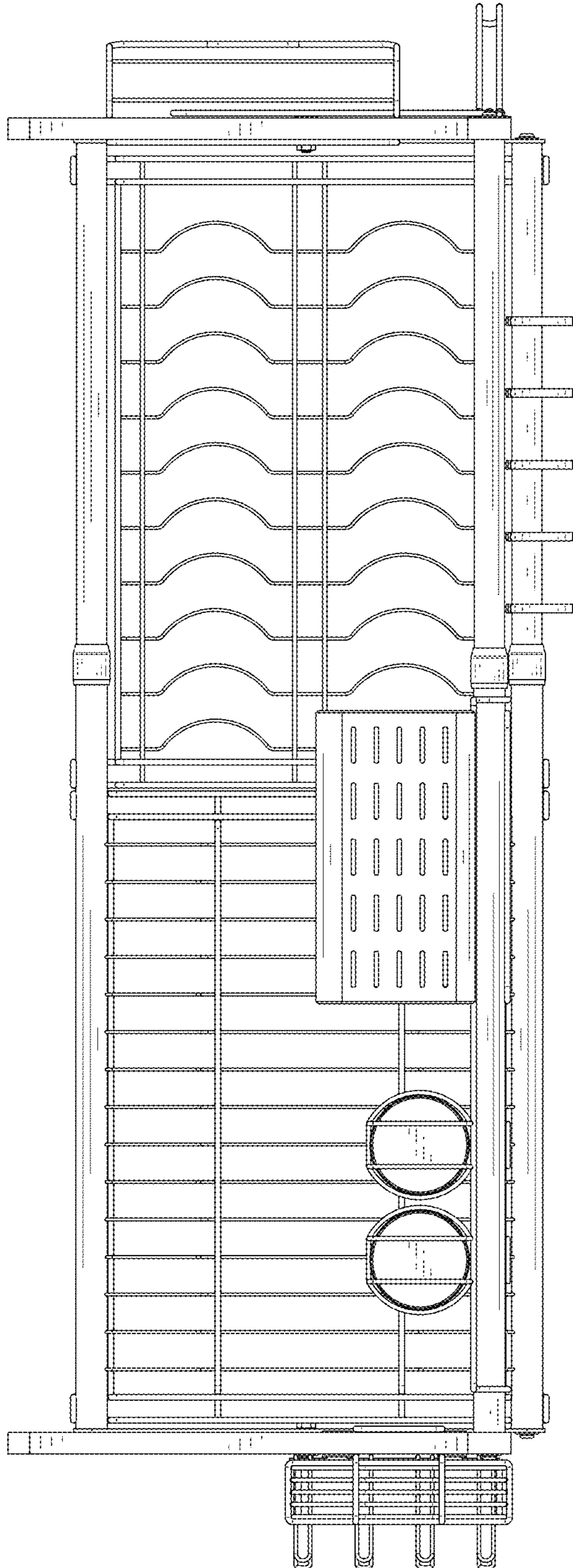

FIG. 8

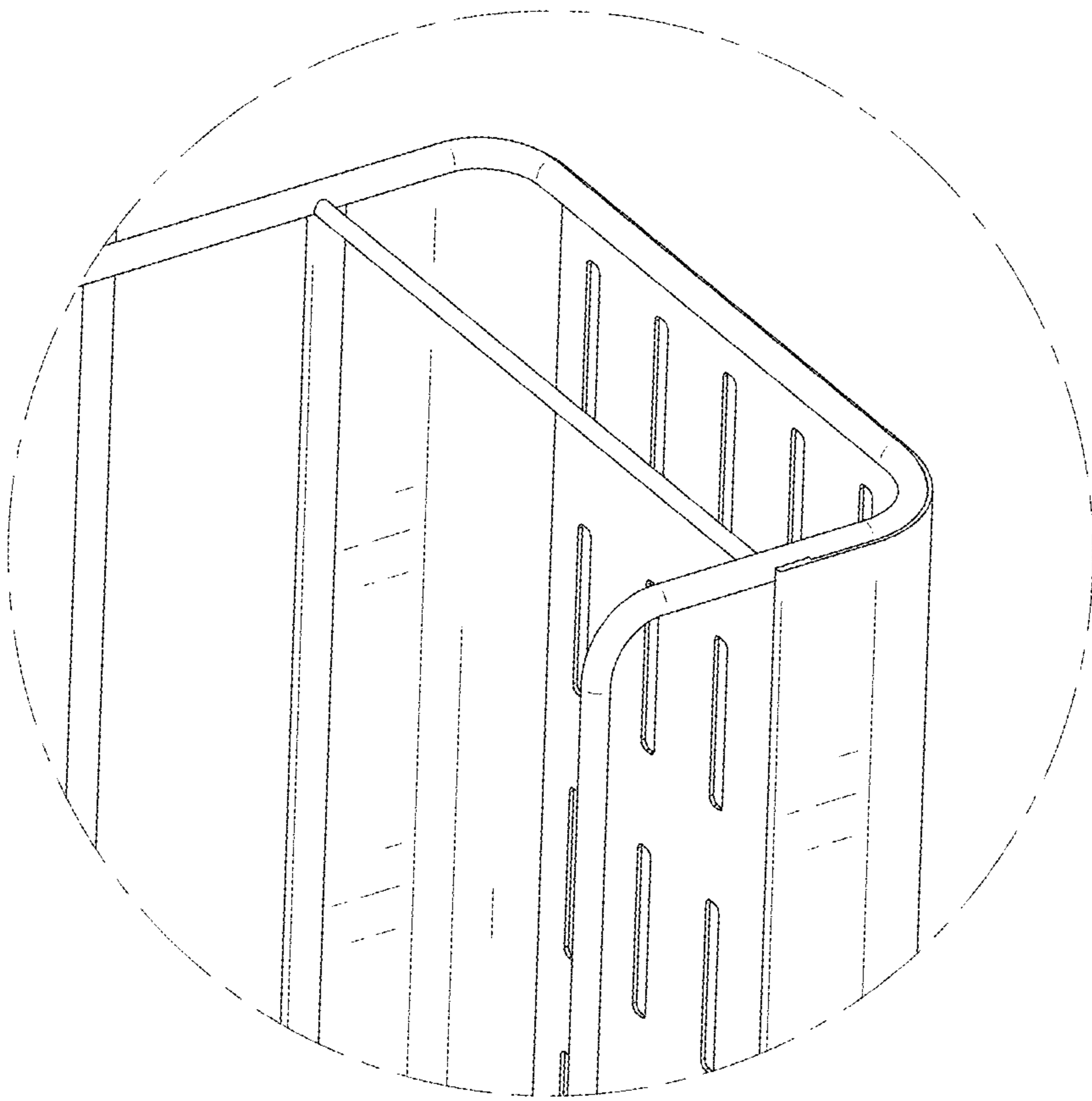

FIG. 9