



US00D922691S

(12) **United States Design Patent**
Wong

(10) **Patent No.:** **US D922,691 S**
(45) **Date of Patent:** **** Jun. 15, 2021**

(54) **SAFETY HELMET**

(71) Applicant: **Klein Tools, Inc.**, Lincolnshire, IL (US)

(72) Inventor: **Kingston Wong**, Lincolnshire, IL (US)

(73) Assignee: **Klein Tools, Inc.**, Lincolnshire, IL (US)

(**) Term: **15 Years**

(21) Appl. No.: **29/688,953**

(22) Filed: **Apr. 25, 2019**

(51) **LOC (13) Cl.** **02-99**

(52) **U.S. Cl.**

USPC **D29/122**

(58) **Field of Classification Search**

USPC D29/122, 102-110; D2/878

CPC .. A42B 3/04; A42B 3/163; A42B 3/08; A42B 3/10; A42B 3/16; A42B 3/166; A42B 3/127; A42B 3/14; A42B 3/142; A42B 3/145; A42B 3/147; A42B 3/32; A42B 7/00; A42B 3/226; A42B 3/227; A42B

(Continued)

(56) **References Cited**

U.S. PATENT DOCUMENTS

2,362,382 A * 11/1944 Lehmberg A41D 13/1146
128/206.15

D241,886 S * 10/1976 Alevras D28/44.2

(Continued)

OTHER PUBLICATIONS

Ergodyne—0156 Vented Hard Hat with Light Full Brim Style (on-line), reviewed Feb. 20, 2020. Retrieved from Internet Feb. 5, 2021, URL: <https://www.amazon.com/Vented-Ratchet-Suspension-Ergodyne-Skullerz/dp/B07W4XFHDT?th=1> (1 page) (Year: 2020).*

(Continued)

Primary Examiner — Kimberly Barnes

(74) *Attorney, Agent, or Firm* — Leydig, Voit & Mayer, Ltd.

(57) **CLAIM**

The ornamental design for a safety helmet, as shown and described.

DESCRIPTION

FIG. 1 is a perspective view taken from the front, top, and right side of a first embodiment for a safety helmet in accordance with the new design.

FIG. 2 is a right side view of the safety helmet shown in FIG. 1.

FIG. 3 is a left side view of the safety helmet shown in FIG. 1.

FIG. 4 is a front view of the safety helmet shown in FIG. 1.

FIG. 5 is a rear view of the safety helmet shown in FIG. 1.

FIG. 6 is a top plan view of the safety helmet shown in FIG. 1.

FIG. 7 is a bottom plan view of the safety helmet shown in FIG. 1.

FIG. 8 is a perspective view taken from the front, top, and right side of a second embodiment for a safety helmet in accordance with the new design.

FIG. 9 is a right side view of the safety helmet shown in FIG. 8.

FIG. 10 is a left side view of the safety helmet shown in FIG. 8.

FIG. 11 is a front view of the safety helmet shown in FIG. 8.

FIG. 12 is a rear view of the safety helmet shown in FIG. 8.

FIG. 13 is a top plan view of the safety helmet shown in FIG. 8; and,

FIG. 14 is a bottom plan view of the safety helmet shown in FIG. 8.

The broken lines shown in the drawings illustrate portions of the safety helmet that form no part of claimed design.

1 Claim, 14 Drawing Sheets

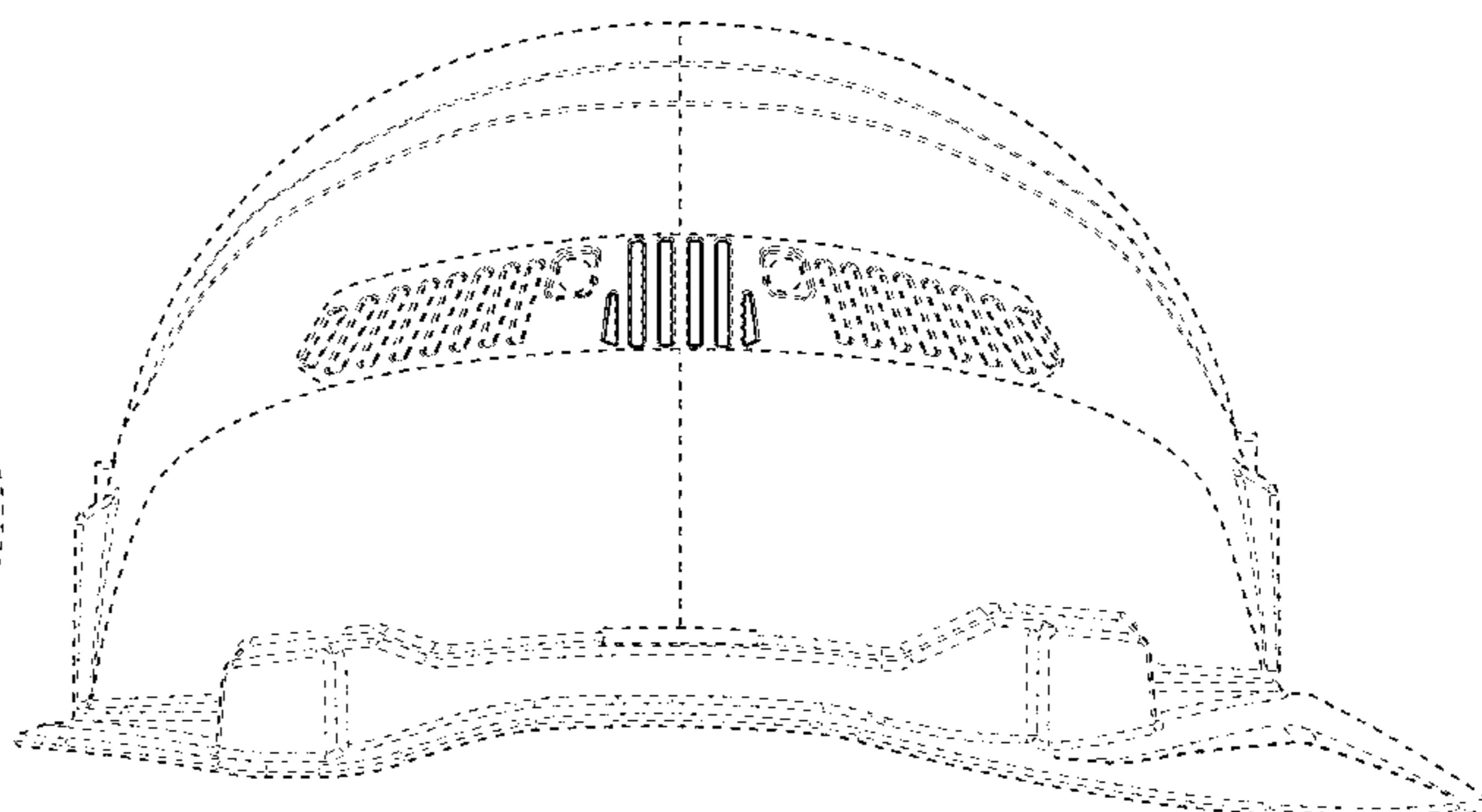
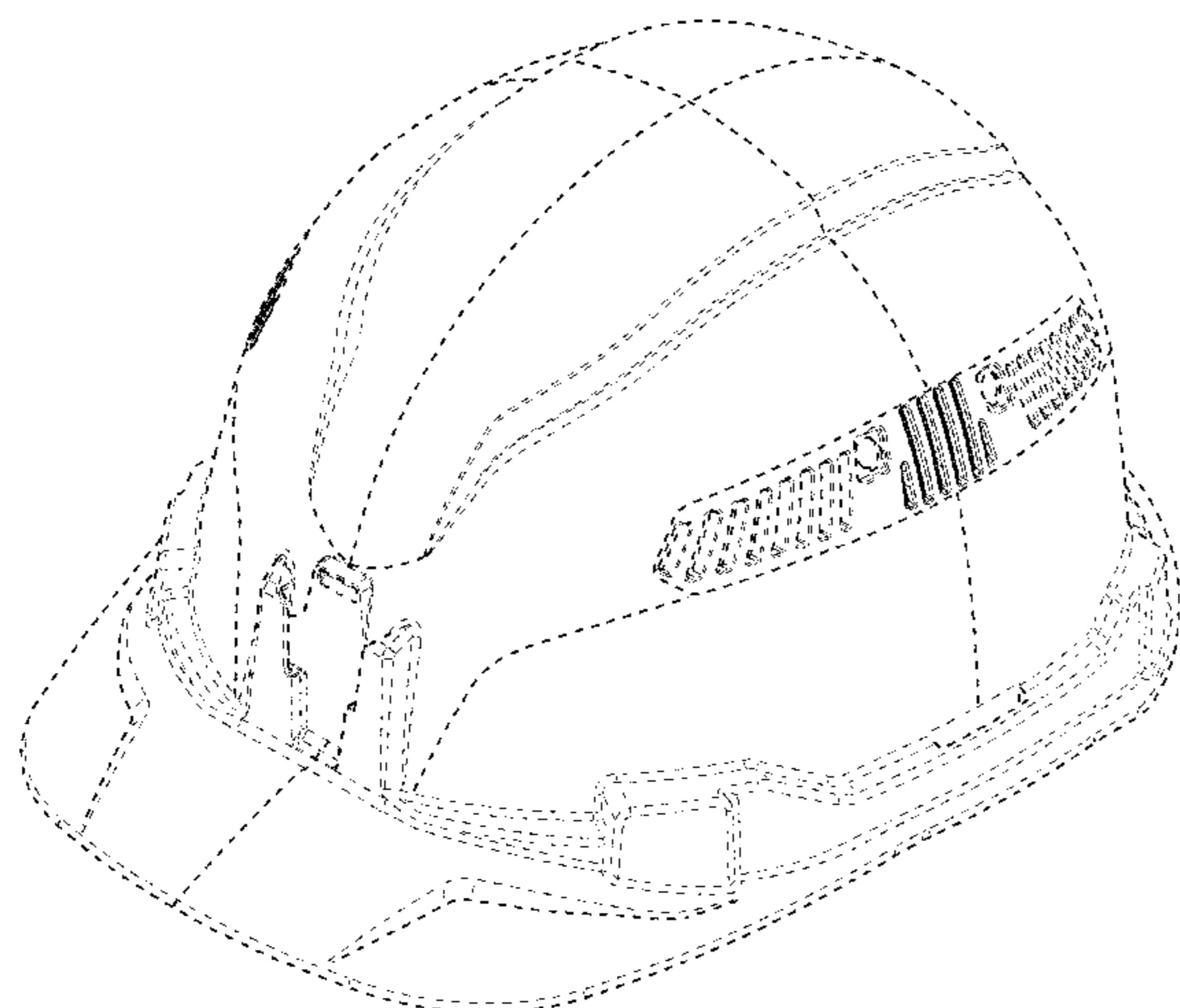

(58) **Field of Classification Search**

CPC 1/248; A42B 3/003; A42B 3/0406; A42B
 3/0426; A42B 3/0433; A42B 3/0493;
 A42B 3/28; A42B 3/283; A61F 11/06
 See application file for complete search history.

(56) **References Cited**

U.S. PATENT DOCUMENTS

D256,851	S	*	9/1980	Knadle	D29/105
D277,520	S	*	2/1985	Gregory	D24/110.1
D280,566	S	*	9/1985	Schwartzburg	D2/876
D311,088	S	*	10/1990	Vargo	D2/876
D317,063	S	*	5/1991	Johnson	D29/110
5,148,550	A	*	9/1992	Hodgkinson	A61F 9/02 2/424
D340,317	S	*	10/1993	Cole	D24/110.1
D459,837	S	*	7/2002	Dupuis	D29/110
D522,697	S	*	6/2006	Chen	D29/108
D525,393	S	*	7/2006	Harris	D29/107
D527,847	S	*	9/2006	Broersma	D29/105

D536,833	S	*	2/2007	Broersma	D29/107
D557,461	S	*	12/2007	Probst	D29/108
D630,383	S	*	1/2011	Broersma	D29/110
D654,633	S	*	2/2012	Anderson	D29/108
D658,333	S	*	4/2012	Folkesson	D29/108
D665,903	S	*	8/2012	Sullivan, Jr.	D24/110.1
D667,590	S	*	9/2012	Williams	D29/102
D741,475	S	*	10/2015	Blomberg	D24/110.1
9,707,444	B1	*	7/2017	Danford	A63B 23/18
D885,559	S	*	5/2020	Gabriel	D24/110.1
10,702,721	B2	*	7/2020	Perusse	A42B 3/286
2019/0365011	A1	*	12/2019	Paulson	A61F 9/068
2020/0329806	A1	*	10/2020	Wong	A42B 3/0406

OTHER PUBLICATIONS

Klein Vented and Non Vented Hard Hat (on-line), dated Sep. 3, 2019. Retrieved from Internet Feb. 5, 2021, URL: <https://toolcraze.net/klein-vented-non-vented-hard-hat-w-headlamp-honest-review/> (3 pages) (Year: 2019).*

* cited by examiner

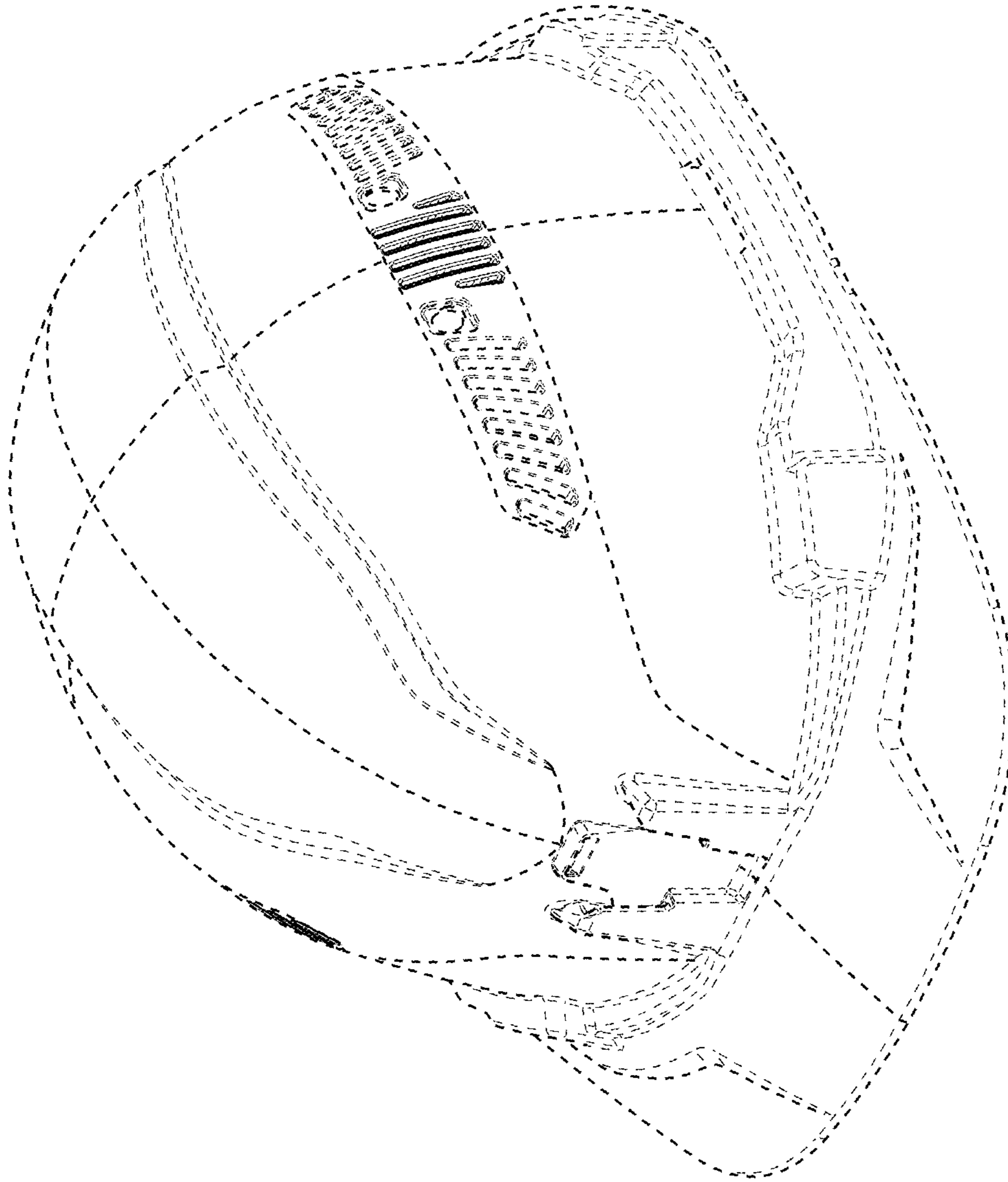

FIG. 1

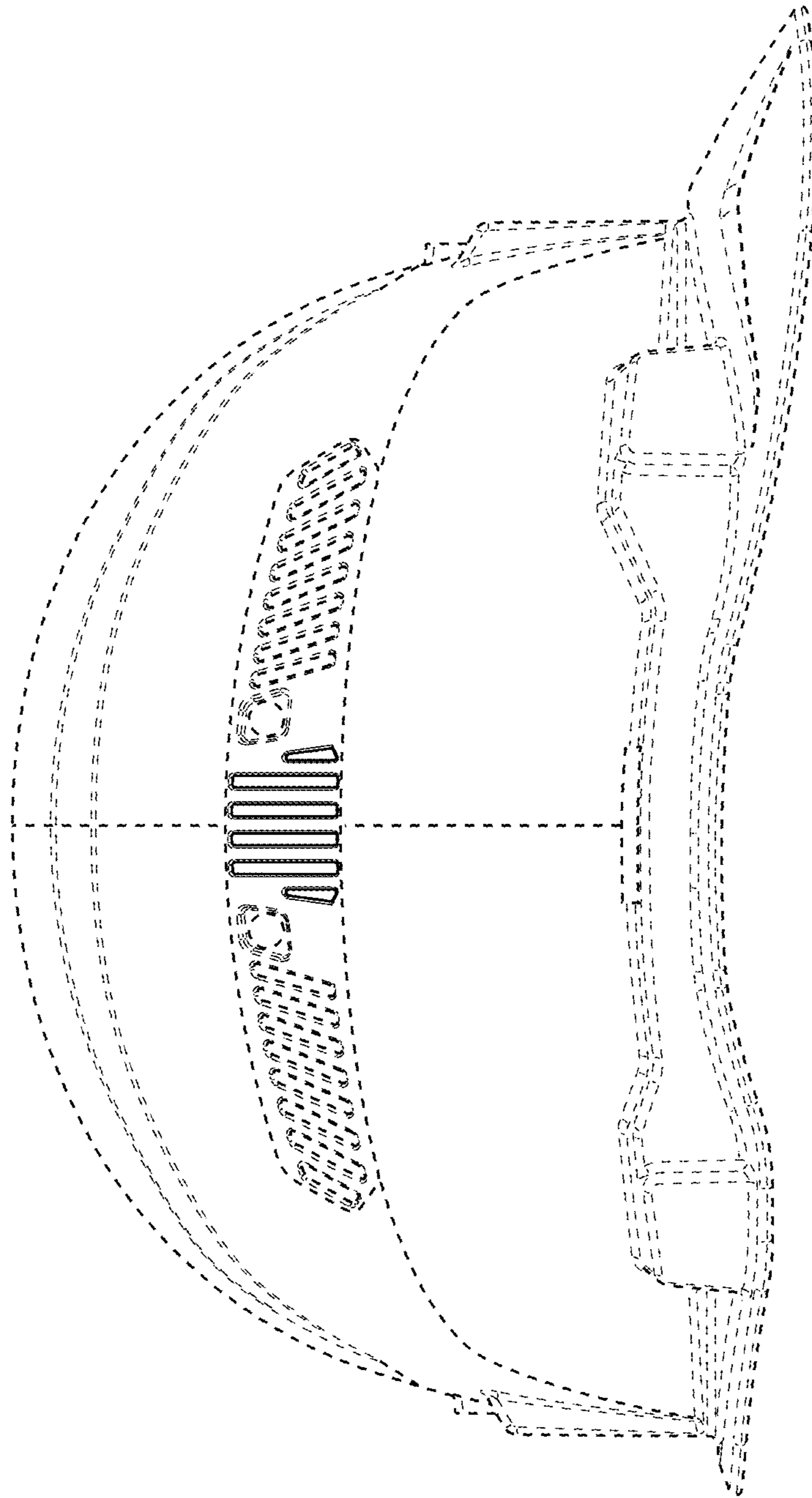

FIG. 2

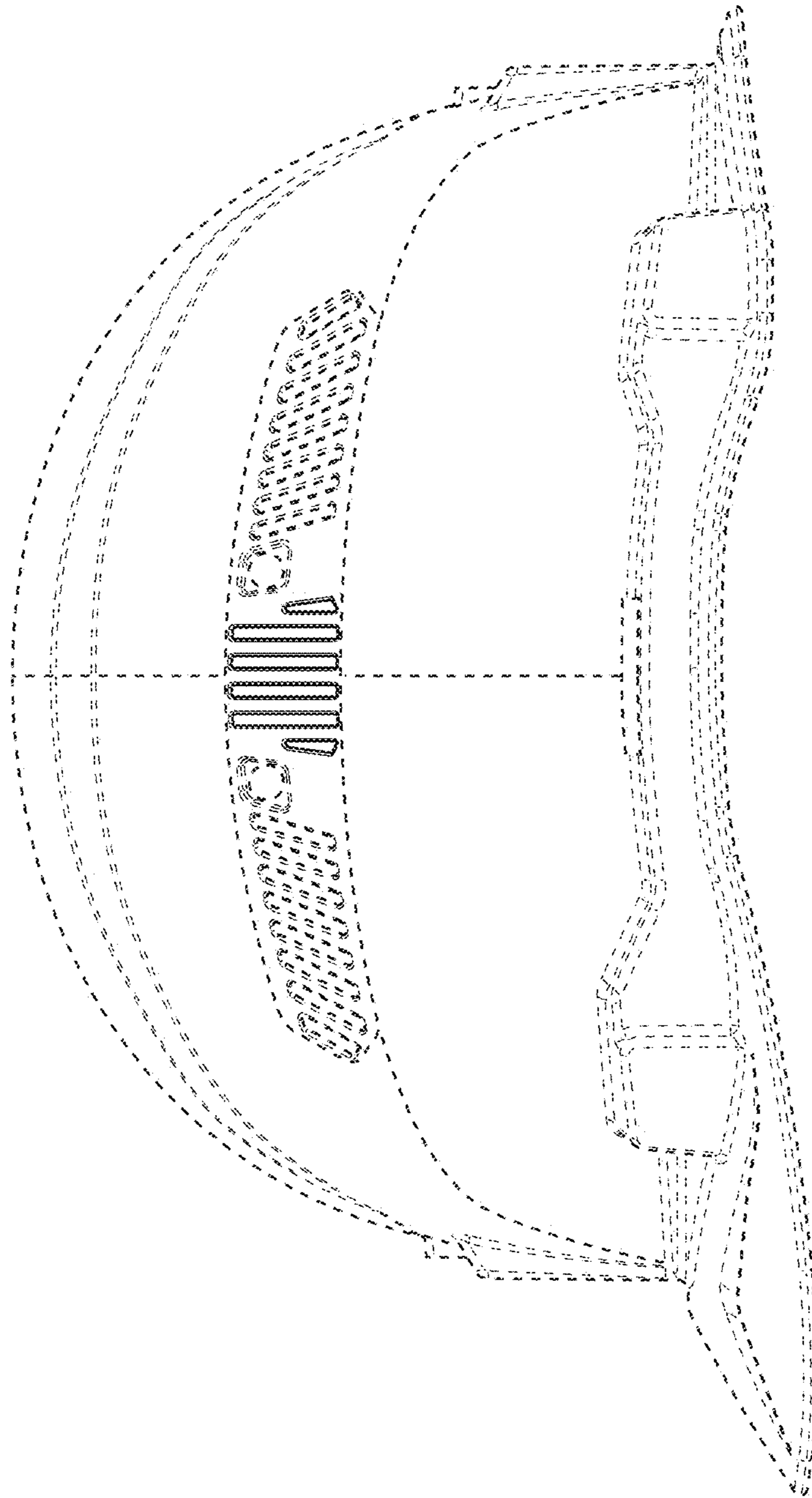

FIG. 3

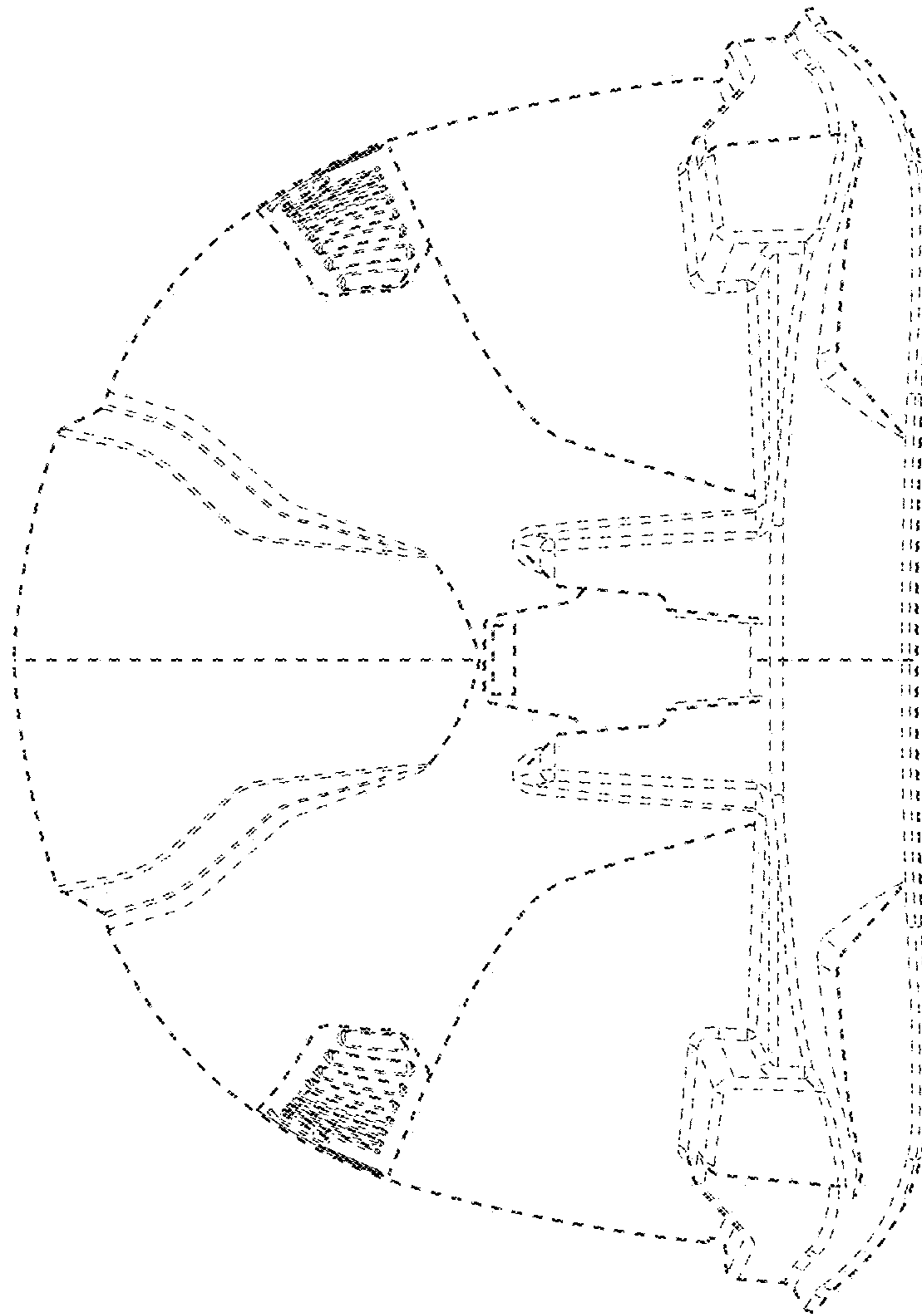

FIG. 4

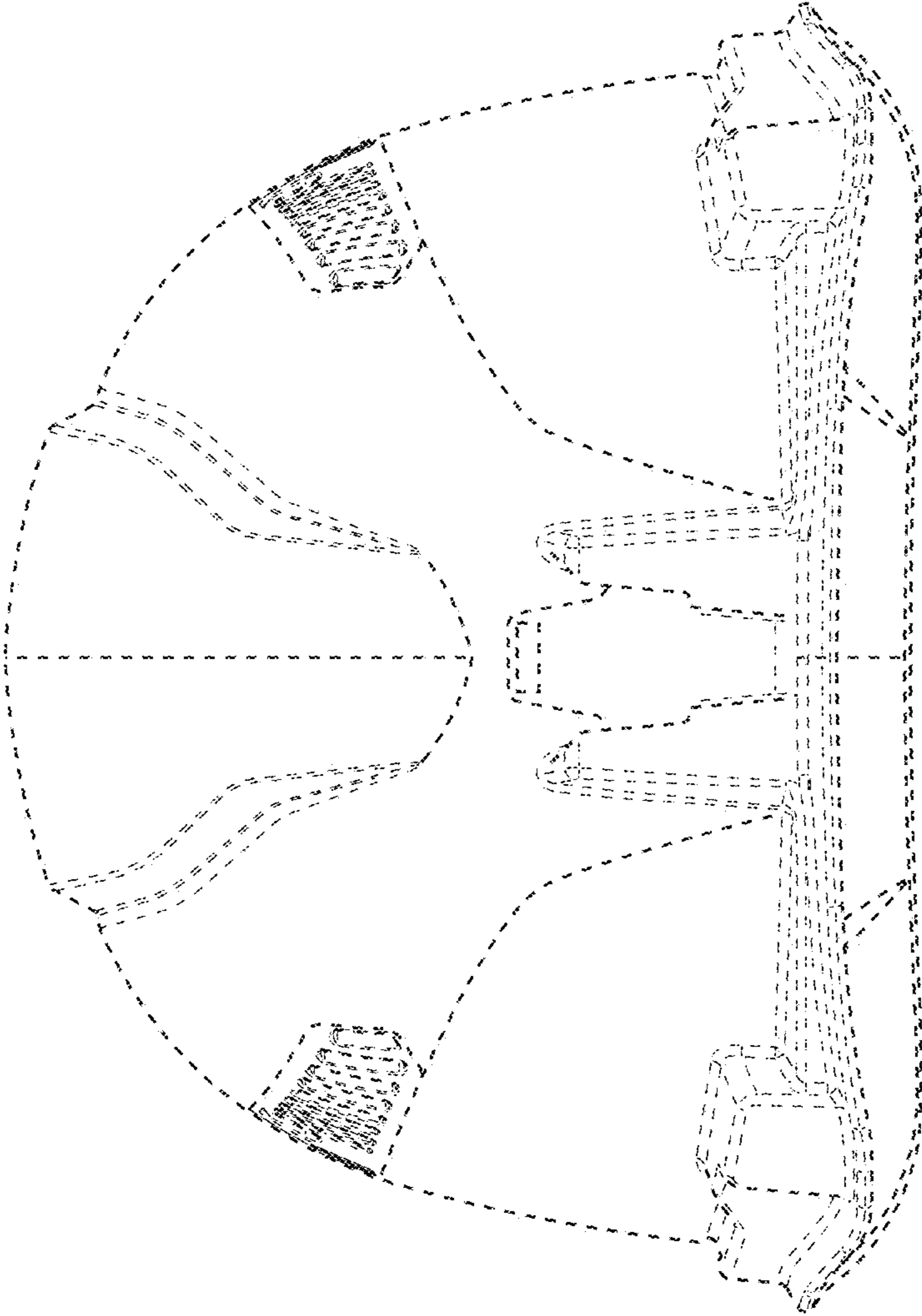

FIG. 5

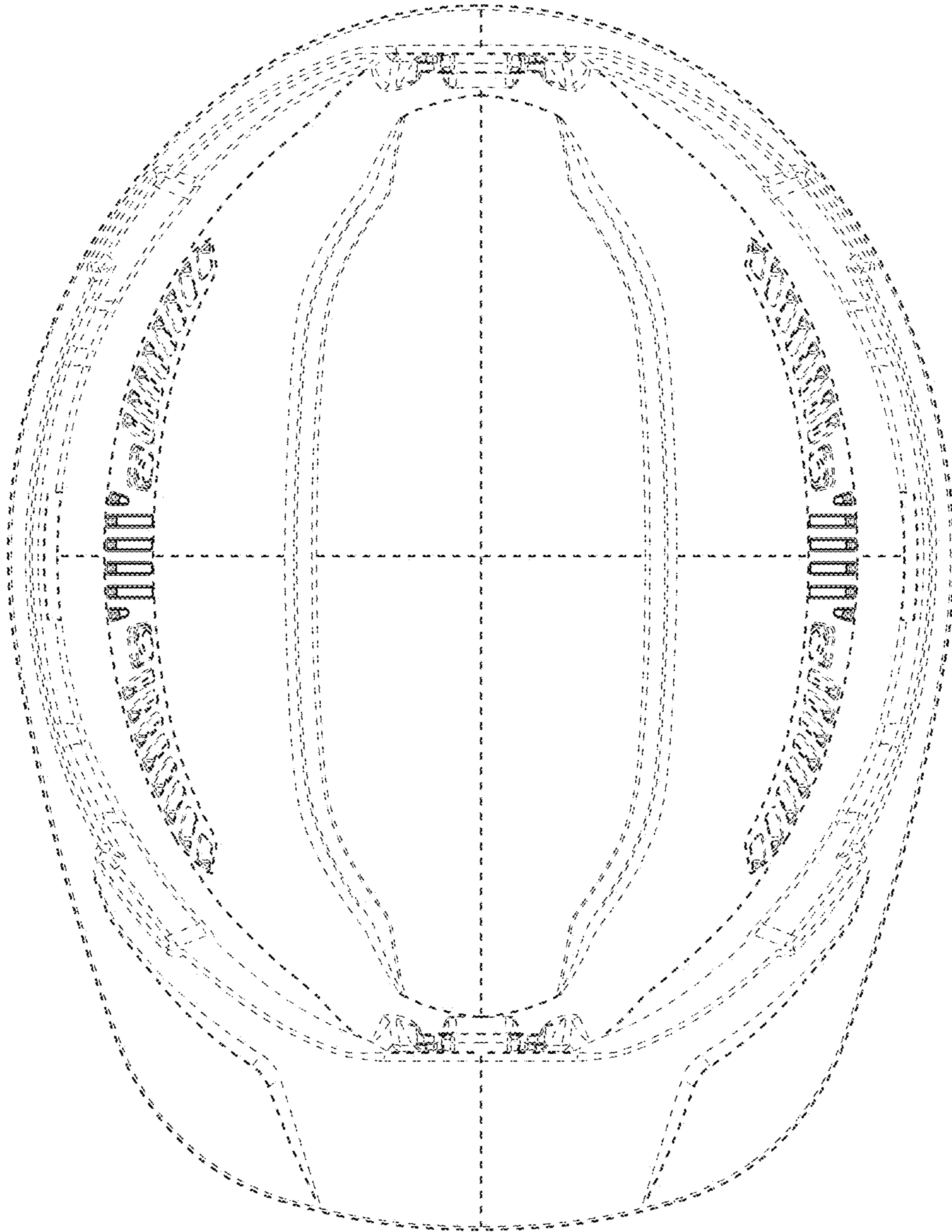

FIG. 6

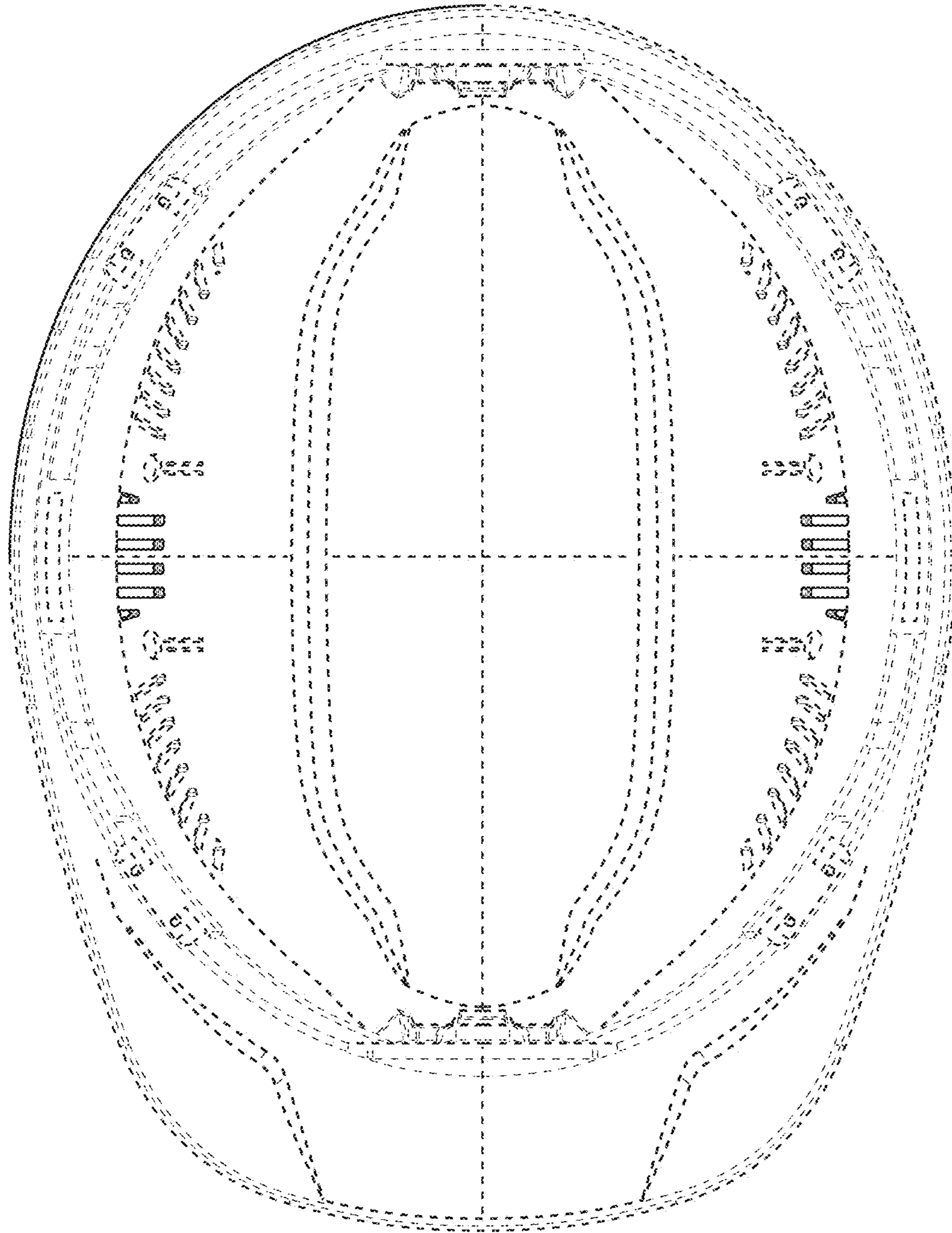

FIG. 7

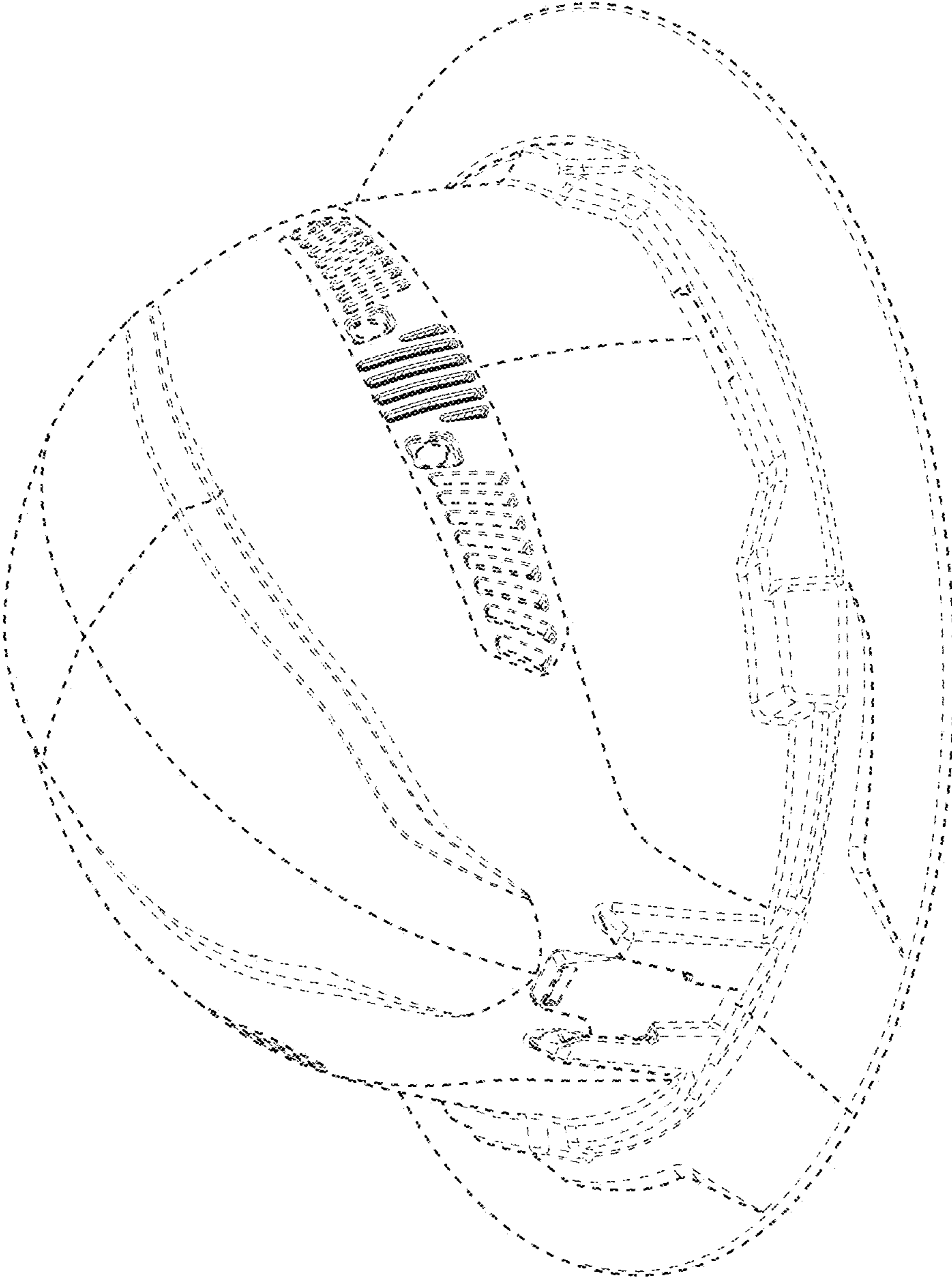

FIG. 8

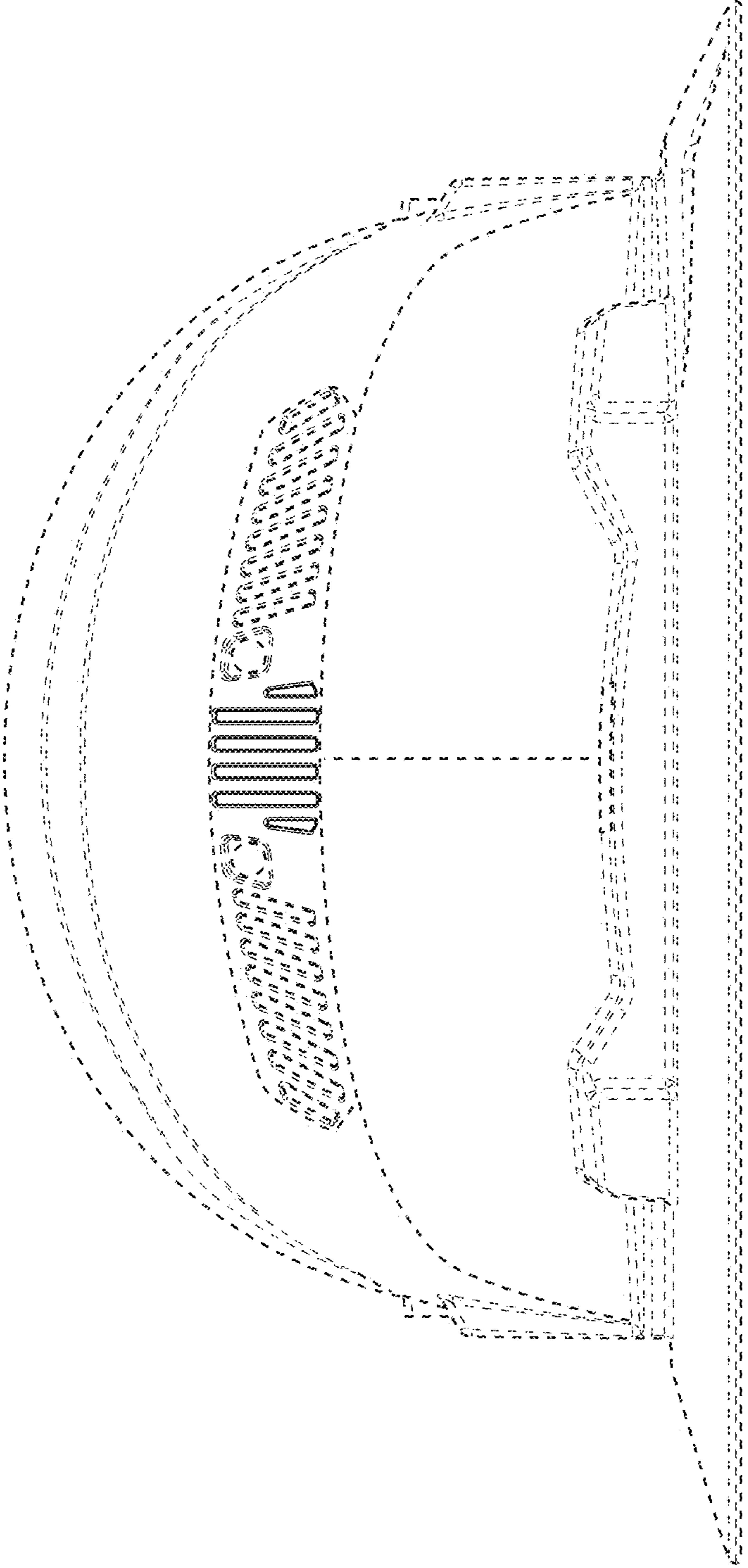

FIG. 9

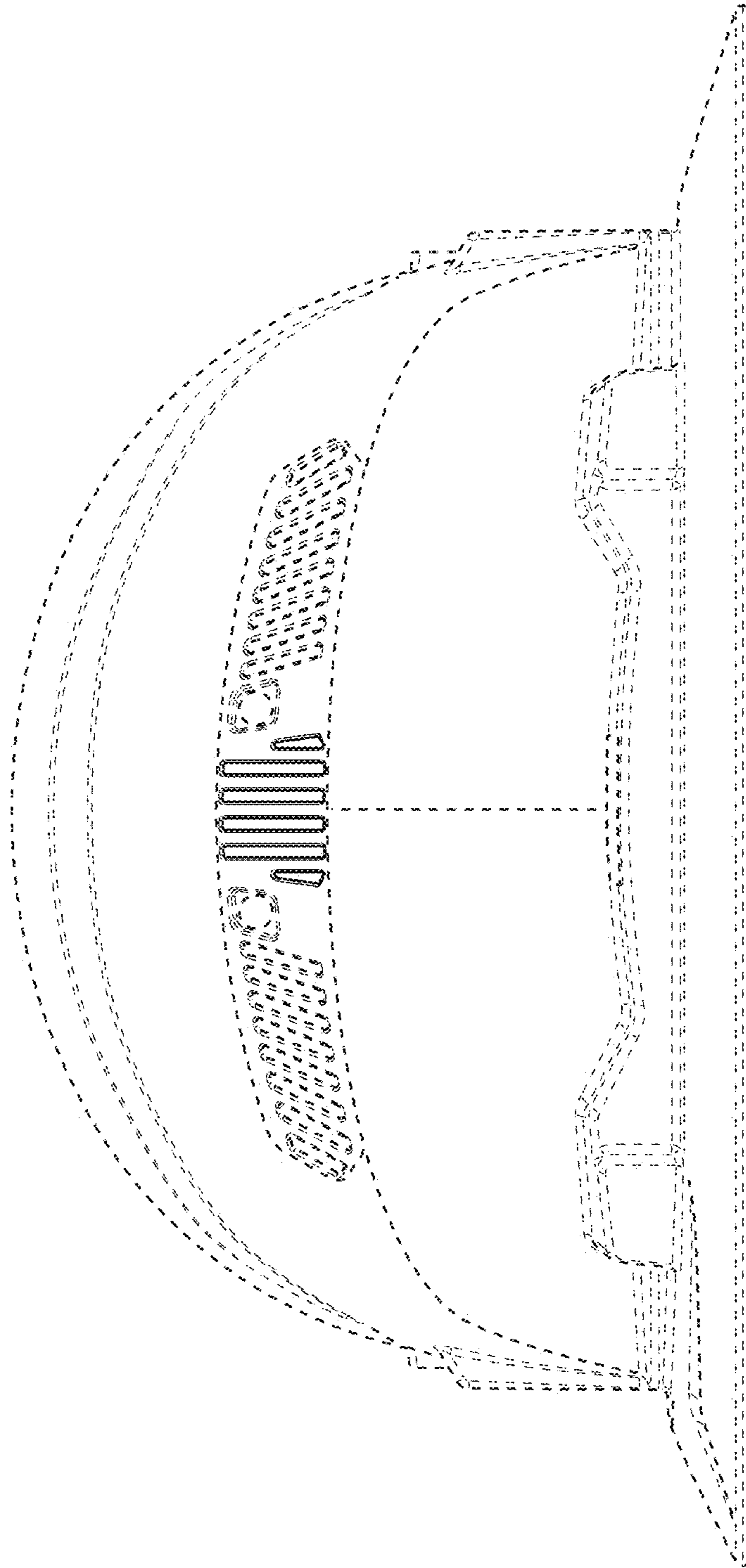

FIG. 10

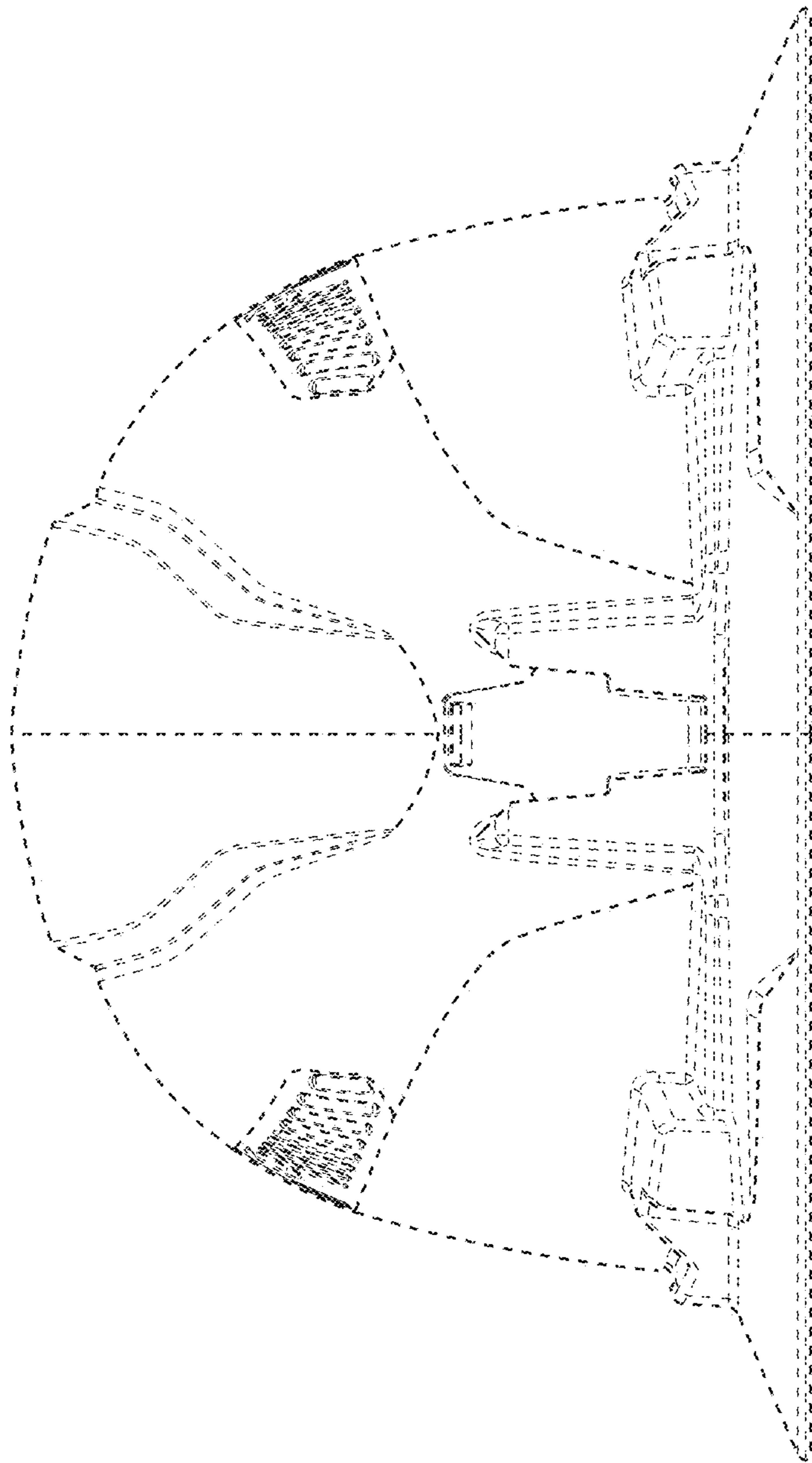

FIG. 11

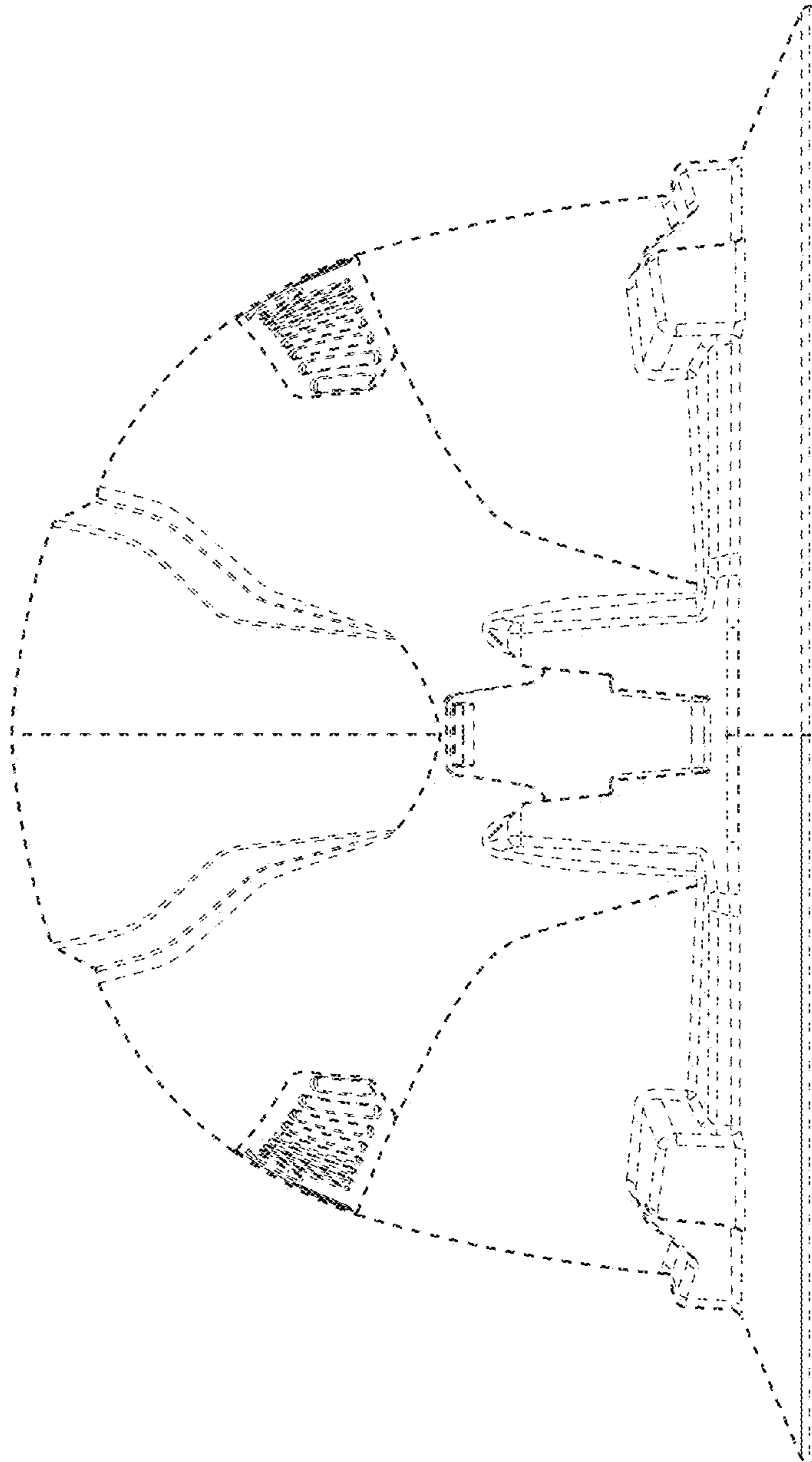

FIG. 12

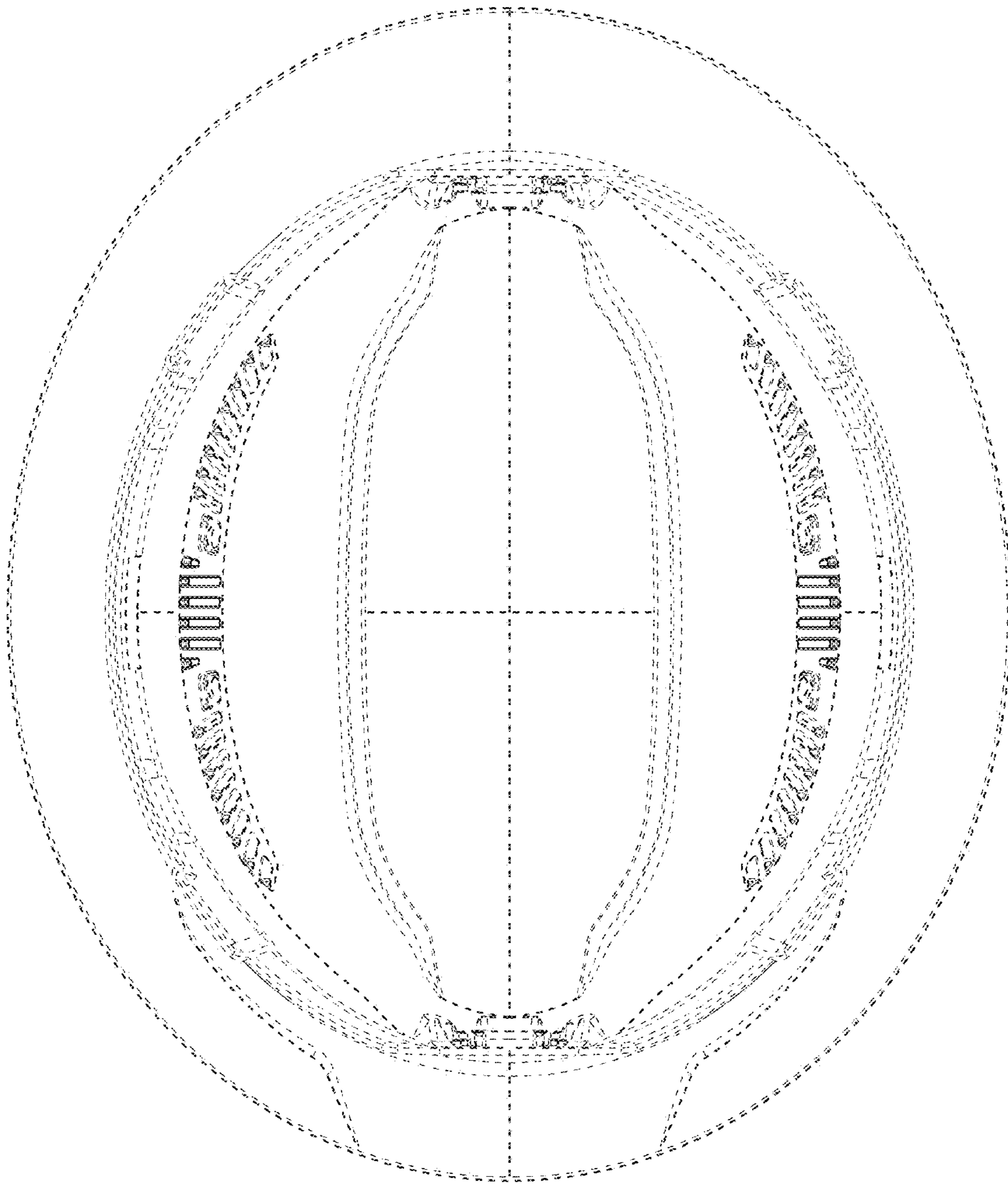

FIG. 13

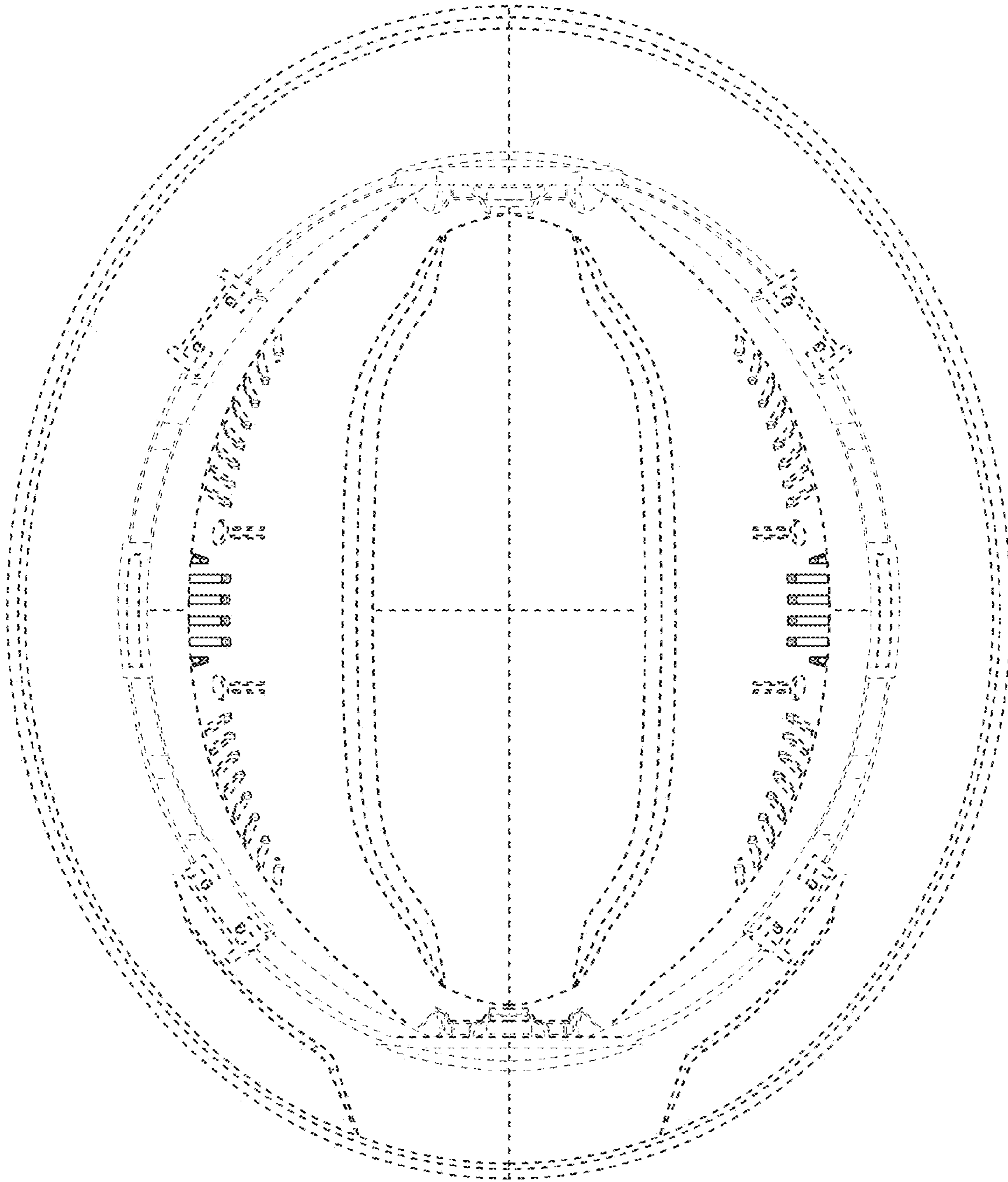

FIG. 14