



US00D922687S

(12) **United States Design Patent**  
**Elliott et al.**

(10) **Patent No.:** **US D922,687 S**  
(45) **Date of Patent:** **\*\* Jun. 15, 2021**

- (54) **MASCARA CONTAINER**
- (71) Applicant: **ELC Management LLC**, Melville, NY (US)
- (72) Inventors: **James Andrew Elliott**, New York, NY (US); **Yeon Jung Roh**, New York, NY (US); **Jinhee Chu**, Riverdale, NY (US); **Rory Gevis**, New York, NY (US); **James Reed**, New York, NY (US)
- (73) Assignee: **ELC Management LLC**, Melville, NY (US)
- (\*\*) Term: **15 Years**
- (21) Appl. No.: **29/736,044**
- (22) Filed: **May 27, 2020**
- (51) **LOC (13) Cl.** ..... **28-03**
- (52) **U.S. Cl.**  
USPC ..... **D28/76**
- (58) **Field of Classification Search**  
USPC ..... D28/7, 4, 76-85, 88, 99; D9/529, 562, D9/549, 558, 503  
CPC ..... A45D 33/00; A45D 33/28; A45D 40/00; A45D 40/262; A45D 2200/1072; A45D 2200/1036; A45D 2200/10091; A45D 2200/1045; A45D 2040/0025  
See application file for complete search history.

- D799,754 S \* 10/2017 Chertoff ..... D28/85
- D828,960 S \* 9/2018 Shugar ..... D28/85
- 10,188,191 B2 \* 1/2019 Dudek ..... A45D 40/00
- D842,548 S \* 3/2019 Langdon ..... D28/76
- D845,132 S \* 4/2019 Otani ..... D9/503
- D884,282 S \* 5/2020 Jung ..... D28/76
- D912,515 S \* 3/2021 Alvarez ..... D9/503

**OTHER PUBLICATIONS**

Eyelash Cream Tube By: Sunrise Cospack limited found on AliExpress (Apr. 17, 2021) <https://www.aliexpress.com/item/32600841916.html> Apr. 17, 2021.\*

\* cited by examiner

*Primary Examiner* — Marissa J Cash  
*Assistant Examiner* — Rebecca Tsehaye  
(74) *Attorney, Agent, or Firm* — Peter Giancana

(57) **CLAIM**

The ornamental design for a mascara container, substantially, as shown and described.

**DESCRIPTION**

FIG. 1 is a front, top perspective view of our new design for a mascara container;  
FIG. 2 is a front, bottom perspective view of the mascara container shown in FIG. 1;  
FIG. 3 is a front elevation view of the mascara container shown in FIG. 1;  
FIG. 4 is a rear elevation view of the mascara container shown in FIG. 1;  
FIG. 5 is a right side elevation view of the mascara container shown in FIG. 1;  
FIG. 6 is a left side elevation view of the mascara container shown in FIG. 1;  
FIG. 7 is a top plan view of the mascara container shown in FIG. 1; and,  
FIG. 8 is a bottom plan view of the mascara container shown in FIG. 1.

**1 Claim, 5 Drawing Sheets**

(56) **References Cited**

**U.S. PATENT DOCUMENTS**

- 2,148,736 A \* 2/1939 Engel, Jr. .... A45D 40/265 401/129
- D361,638 S \* 8/1995 Desgrippes ..... D28/76
- D570,051 S \* 5/2008 Bakic ..... D28/88
- D580,597 S \* 11/2008 Mascotte ..... D28/76
- D589,362 S \* 3/2009 Takounseun ..... D9/691
- D646,439 S \* 10/2011 Ancorotti ..... D28/76
- D739,084 S \* 9/2015 Hall ..... D28/85
- D748,865 S \* 2/2016 Hall ..... D28/85

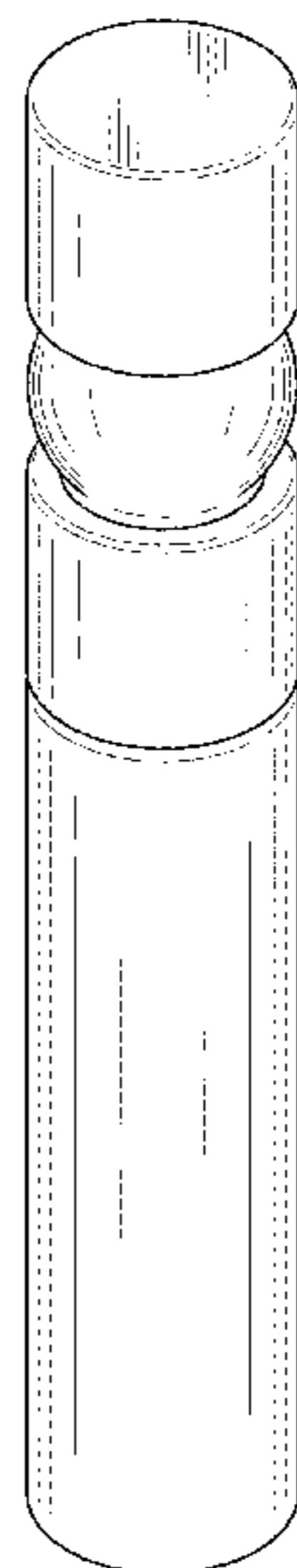

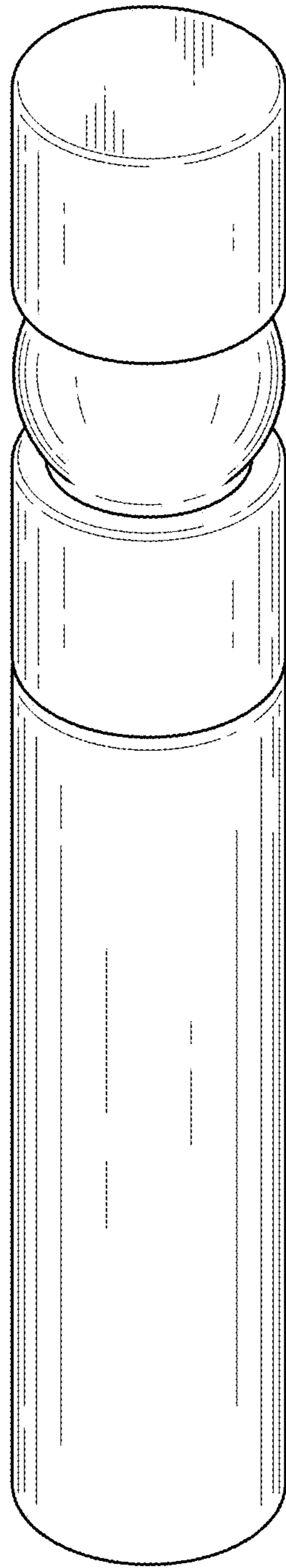

FIG. 1

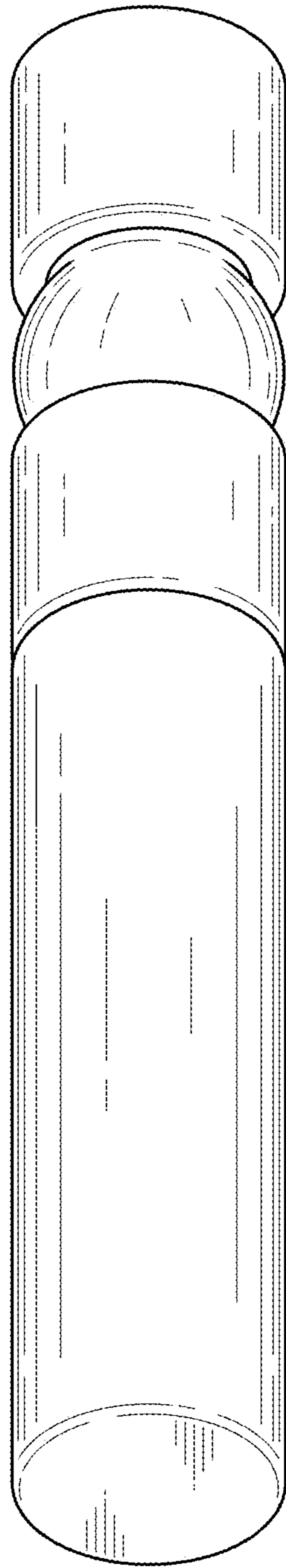

FIG. 2

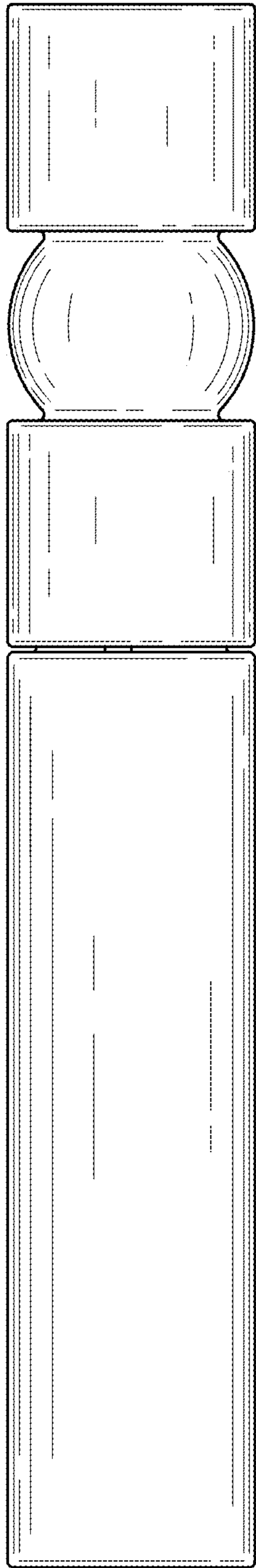

FIG. 3

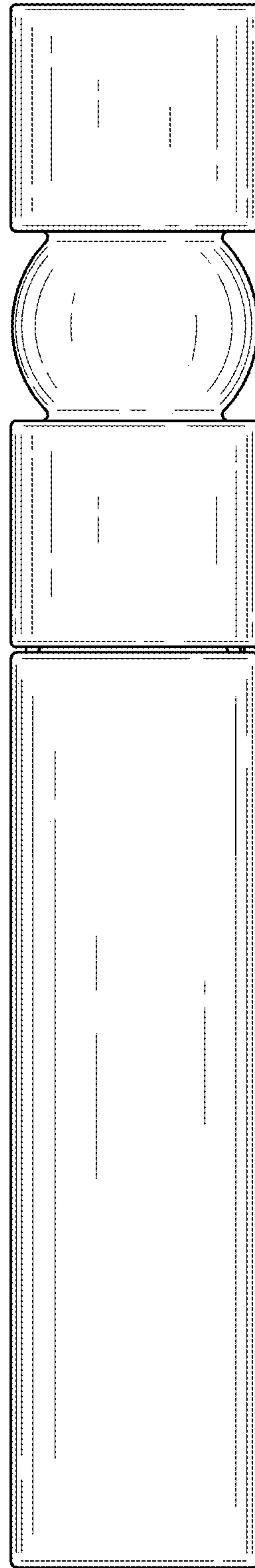

FIG. 4

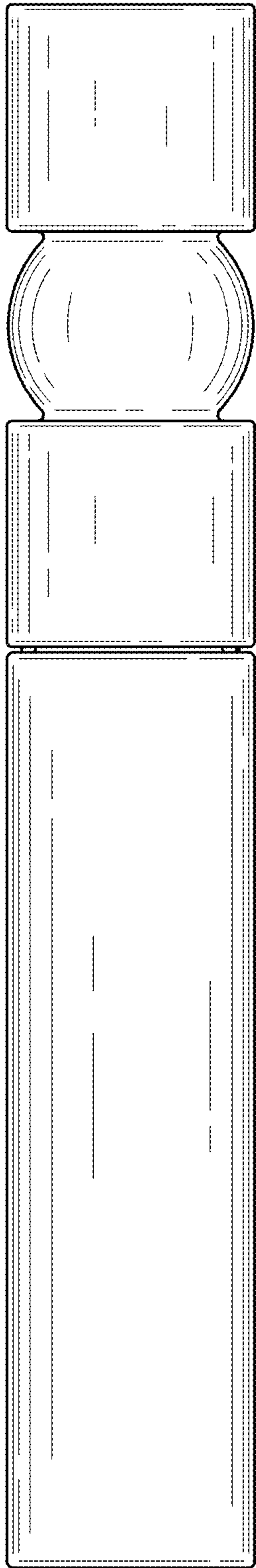

FIG. 5

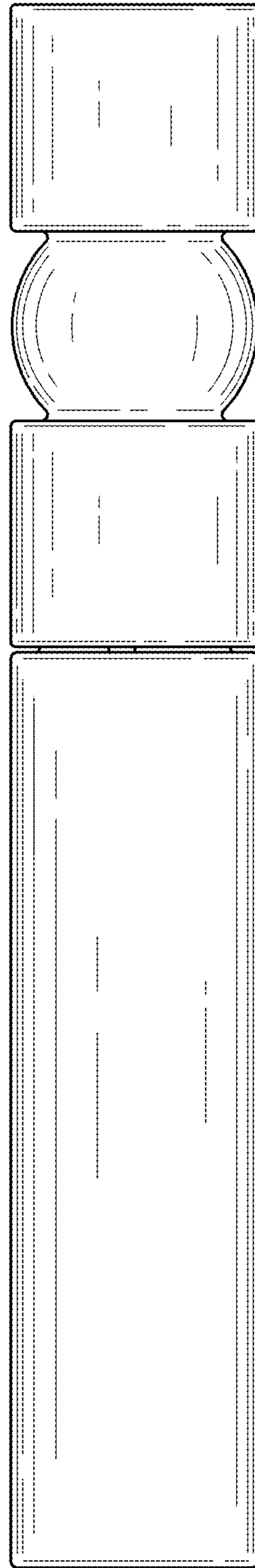

FIG. 6

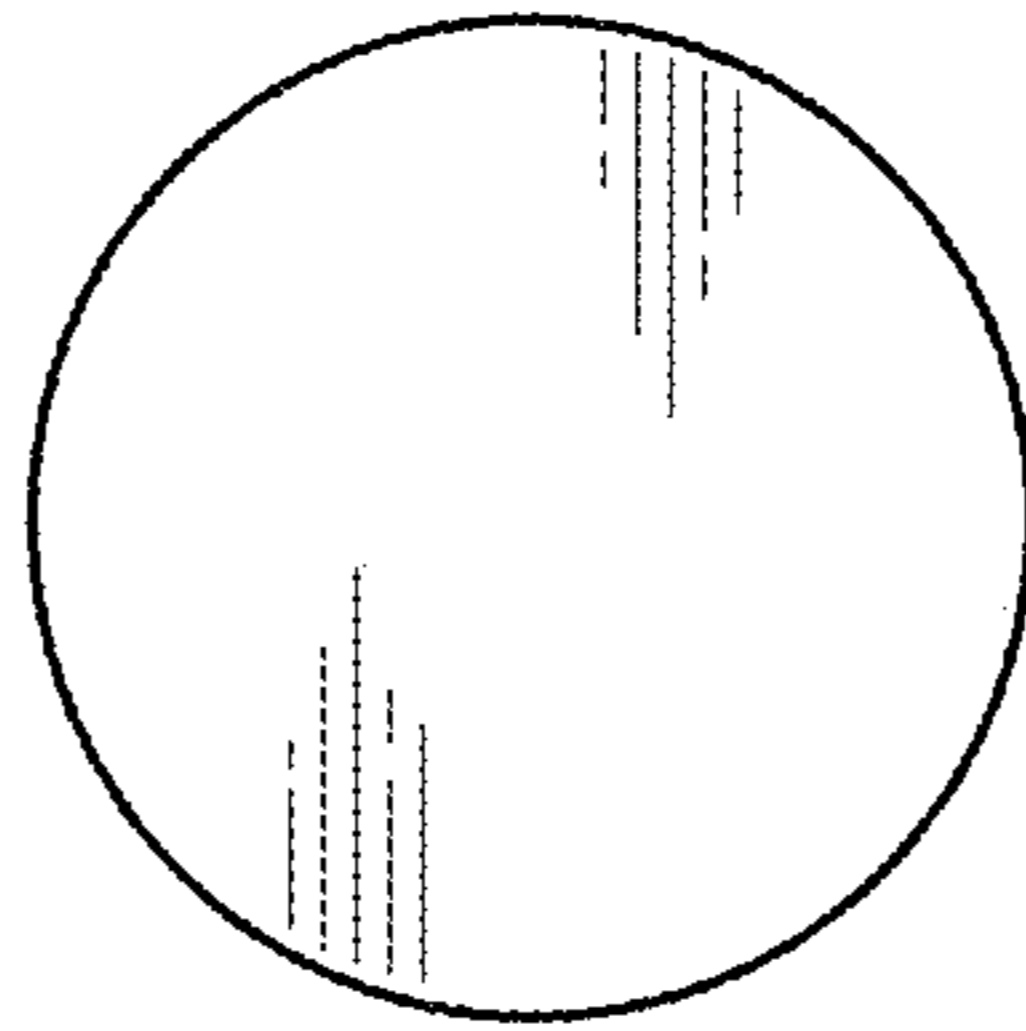

FIG. 7

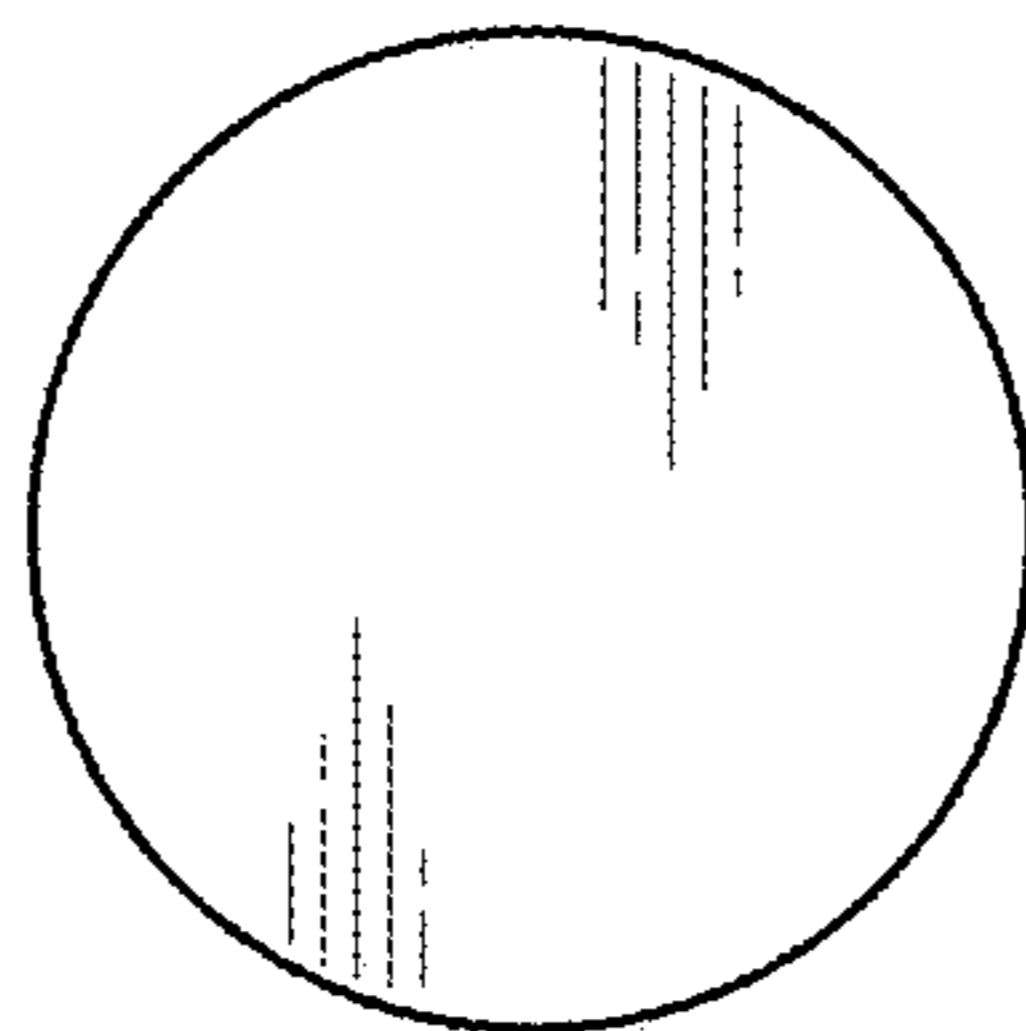

FIG. 8