



US00D922678S

(12) **United States Design Patent** (10) **Patent No.:** **US D922,678 S**
Ziering et al. (45) **Date of Patent:** **** Jun. 15, 2021**

(54) **CASE FOR CIGARETTE PRODUCTS**

(71) Applicant: **PAQ Holdings, LLC.**, Boca Raton, FL (US)

(72) Inventors: **Cody Ziering**, Boca Raton, FL (US);
Brett Gelfand, Atlanta, GA (US);
Mark Rottenberg, Reisterstown, MD (US)

(73) Assignee: **PAQ Holdings, LLC.**, Boca Raton, FL (US)

(**) Term: **15 Years**

(21) Appl. No.: **29/705,679**

(22) Filed: **Sep. 13, 2019**

(51) **LOC (13) Cl.** **27-06**

(52) **U.S. Cl.**
USPC **D27/183**

(58) **Field of Classification Search**
USPC D27/102, 136, 137, 163, 167, 172, 173,
D27/174, 175, 176, 177, 178, 179, 180,
(Continued)

(56) **References Cited**

U.S. PATENT DOCUMENTS

1,574,566 A * 2/1926 Fiske A24F 15/12
206/265
D142,511 S * 10/1945 Beveridge D27/189
(Continued)

FOREIGN PATENT DOCUMENTS

CN 201830663468.8 * 4/2019
WO D103772-010 * 2/2019

Primary Examiner — Marissa J Cash

Assistant Examiner — William B Melliar

(74) *Attorney, Agent, or Firm* — Michael Bednarek;
Bednarek Legal, PLLC

(57) **CLAIM**

The ornamental design for a case for cigarette products, as shown and described.

DESCRIPTION

FIG. 1 is a front perspective view of a first embodiment of case for cigarette products shown in the open position, FIG. 2 is a front elevational view of the case in the open position; FIG. 3 is a rear elevational view of the case in the open position; FIG. 4 is a left side elevational view of the case in the open position; FIG. 5 is a right-side elevational view of the case in the open position; FIG. 6 is a top plan view of the case in the open position; FIG. 7 is a bottom plan view of the case in the open position; FIG. 8 is a front perspective view of a second embodiment of case for cigarette products shown in the open position, FIG. 9 is a front elevational view of the case in the open position; FIG. 10 is a rear elevational view of the case in the open position; FIG. 11 is a left side elevational view of the case in the open position; FIG. 12 is a right-side elevational view of the case in the open position; FIG. 13 is a top plan view of the case in the open position; FIG. 14 is a bottom plan view of the case in the open position; FIG. 15 is a front perspective view of a second embodiment of case for cigarette products shown in the closed position, FIG. 16 is a front elevational view of the case in the closed position; FIG. 17 is a rear elevational view of the case in the closed position; FIG. 18 is a left side elevational view of the case in the closed position; FIG. 19 is a right-side elevational view of the case in the closed position; FIG. 20 is a top plan view of the case in the closed position; and,

(Continued)

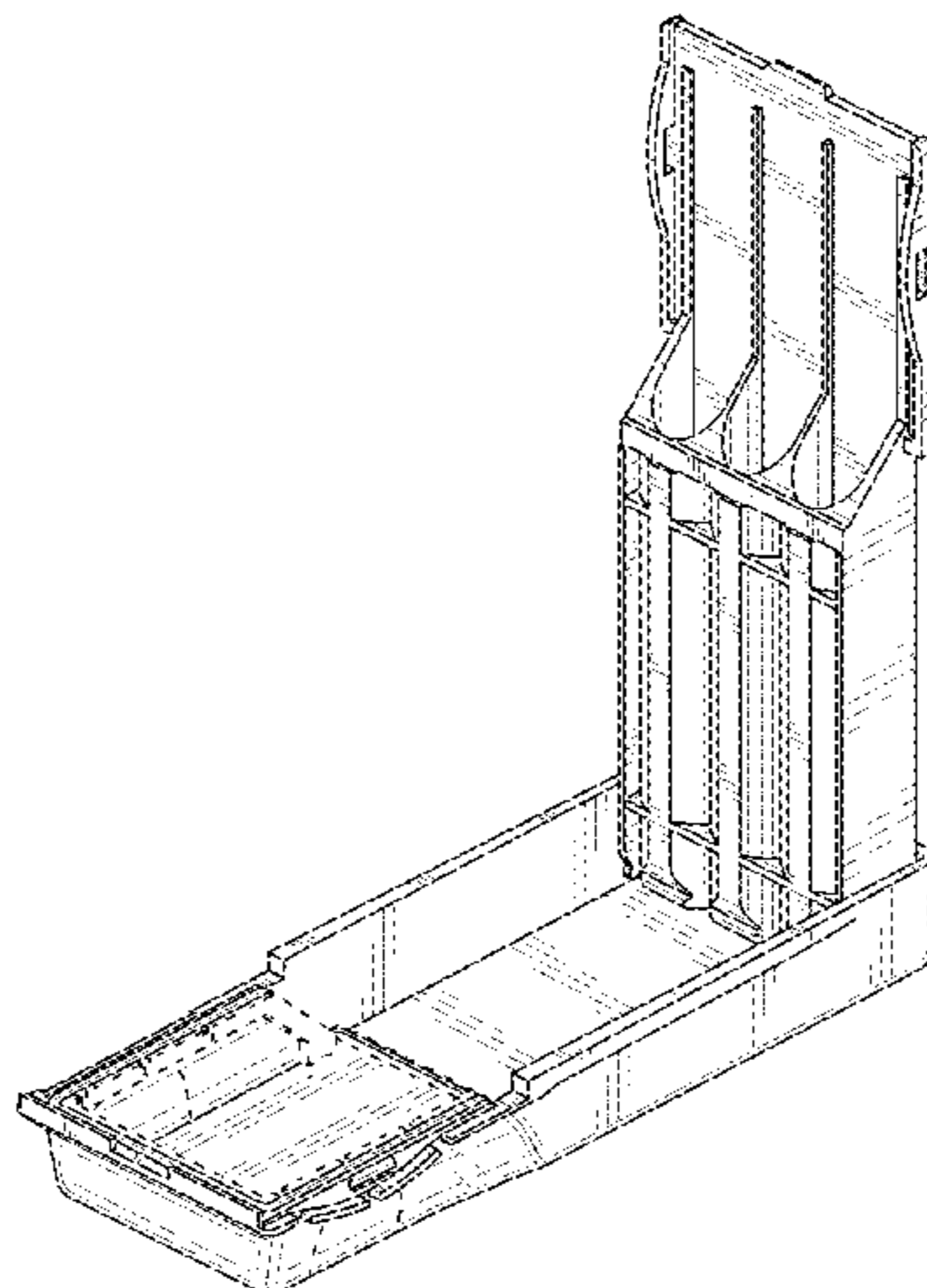

FIG. 21 is a bottom plan view of the case in the closed position.

The broken lines depicted in drawings are directed to environment and are for illustrative purposes only.

1 Claim, 21 Drawing Sheets

77/042; B65D 7/06; B65D 85/1009;
B65D 85/12; B65D 25/22; B65D 5/60;
B65D 81/022; B65D 85/1045; B65D
85/109

See application file for complete search history.

(58) Field of Classification Search

USPC D27/181, 182, 183, 184, 185, 186, 187,
D27/188, 189, 190, 191, 192, 193, 194,
D27/195, 196; D19/102, 77, 81
CPC A24F 47/008; A24F 15/18; A24F 15/12;
A24F 15/20; A24F 47/002; A24F 15/00;
A24F 15/14; A24F 15/10; A24F 15/01;
A24F 15/08; A24F 40/40; A24F 15/005;
A24F 15/02; A24F 21/00; A24F 40/95;
A24F 47/00; A24F 9/04; B65D 85/70;
B65D 25/108; B65D 43/16; B65D 25/10;
B65D 85/10; B65D 43/22; B65D 85/20;
B65D 2203/02; B65D 25/00; B65D
25/34; B65D 43/14; B65D 43/163; B65D
43/165; B65D 43/18; B65D 43/24; B65D

(56)

References Cited

U.S. PATENT DOCUMENTS

D173,597	S *	11/1954	Waterman	B65D 39/08 D9/756
D335,819	S *	5/1993	Campbell	D27/172
D379,552	S *	5/1997	Vokebe	D27/189
D756,560	S *	5/2016	Ghiotti	D27/186
D756,561	S *	5/2016	Ghiotti	D27/186
D756,562	S *	5/2016	Ghiotti	D27/186
D815,344	S *	4/2018	Smith	D27/189
D818,195	S *	5/2018	Burger	D27/186
D835,901	S *	12/2018	Kietzmann	D3/203.1
D890,421	S *	7/2020	Godwin, III	D27/186
D893,095	S *	8/2020	Ziering	D27/189
2017/0349338	A1 *	12/2017	Ziering	B65D 85/10
2019/0100360	A1 *	4/2019	Ziering	B65D 43/16

* cited by examiner

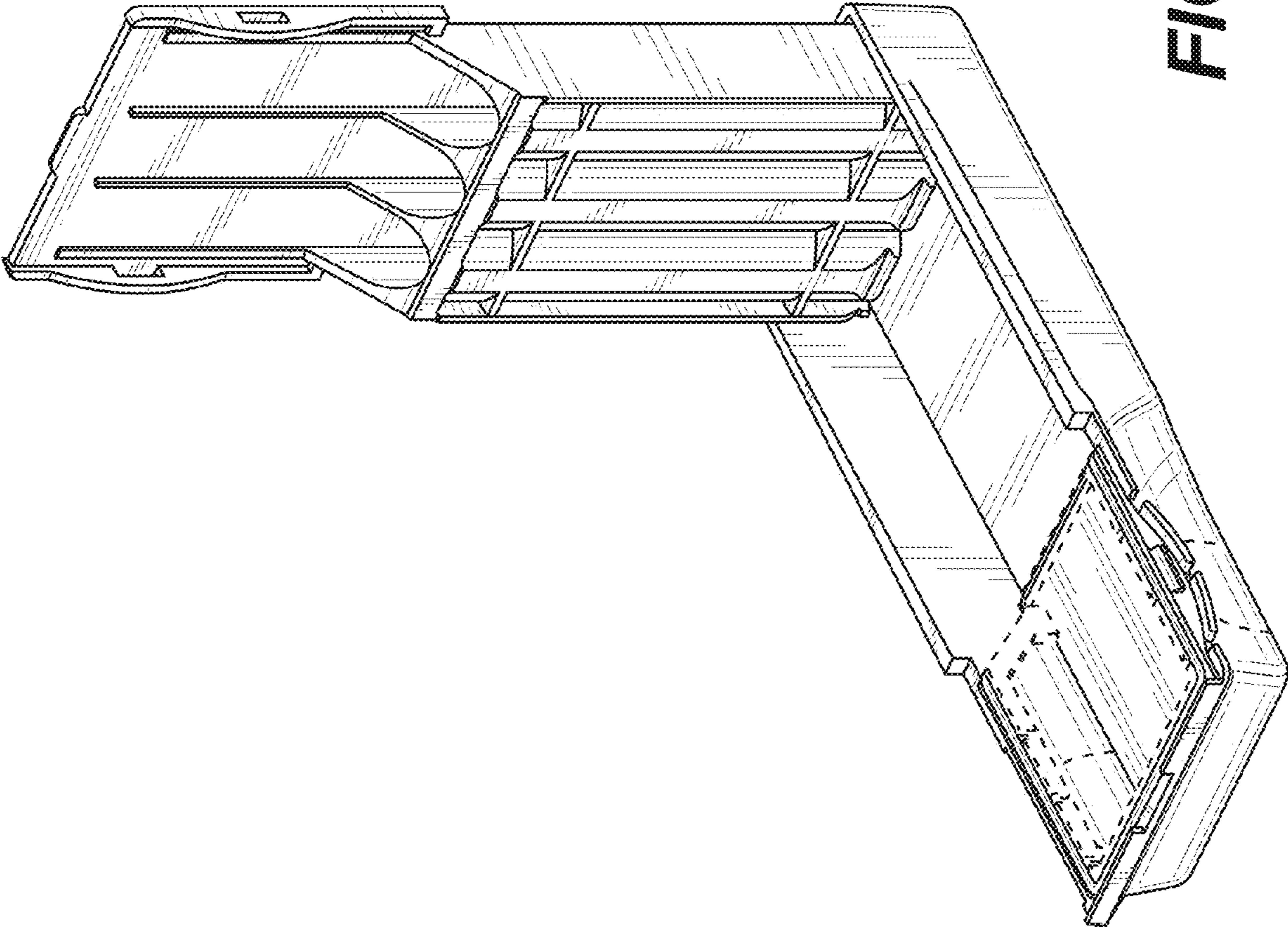

FIG. 1

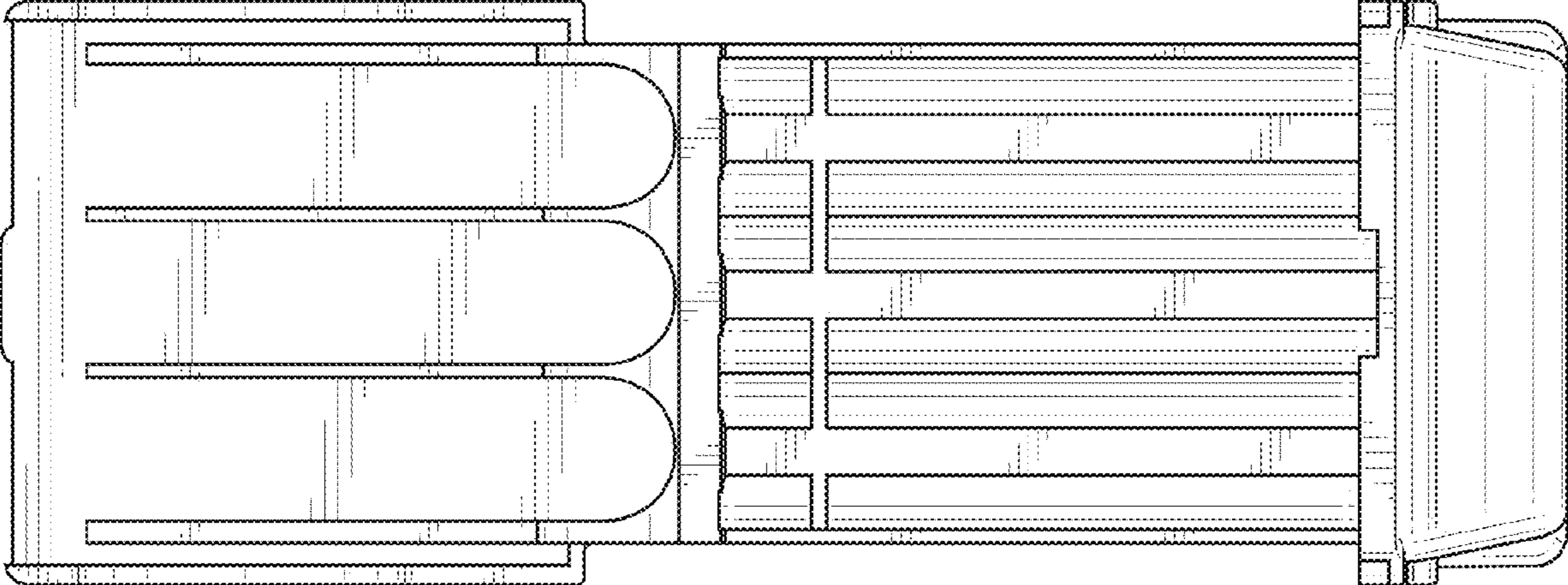

FIG. 2

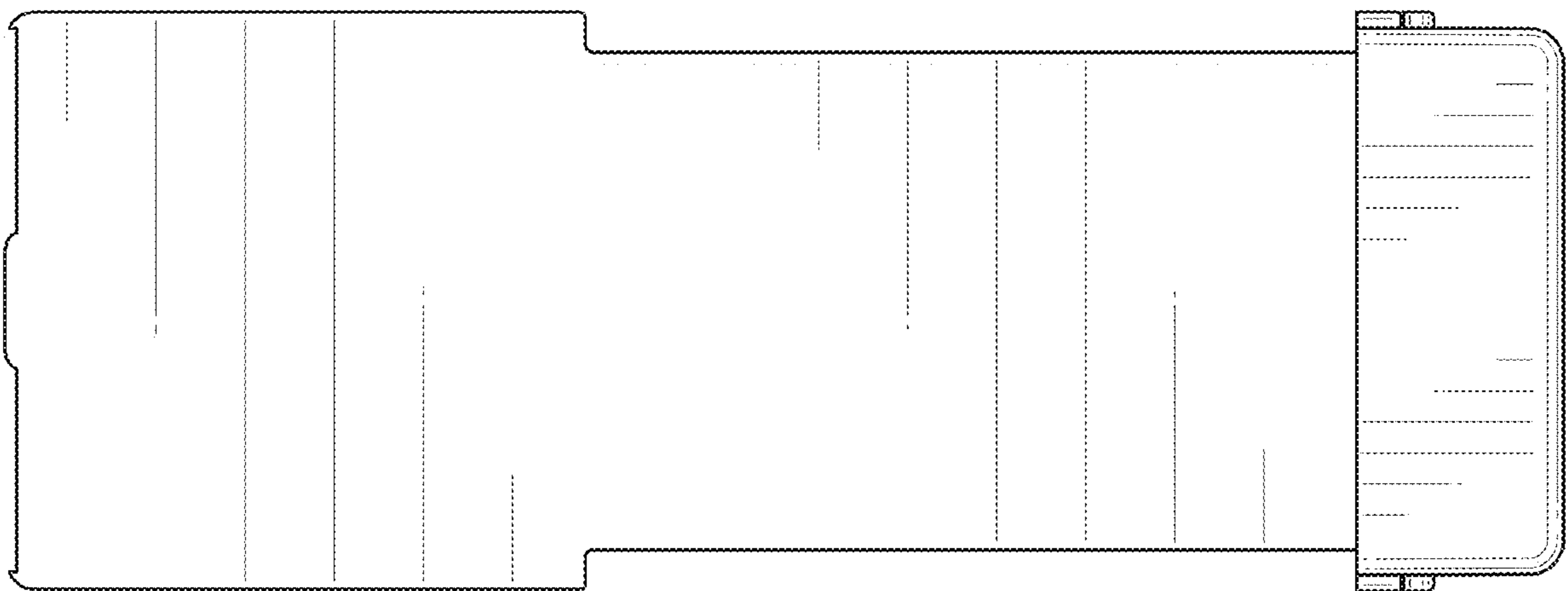

FIG. 3

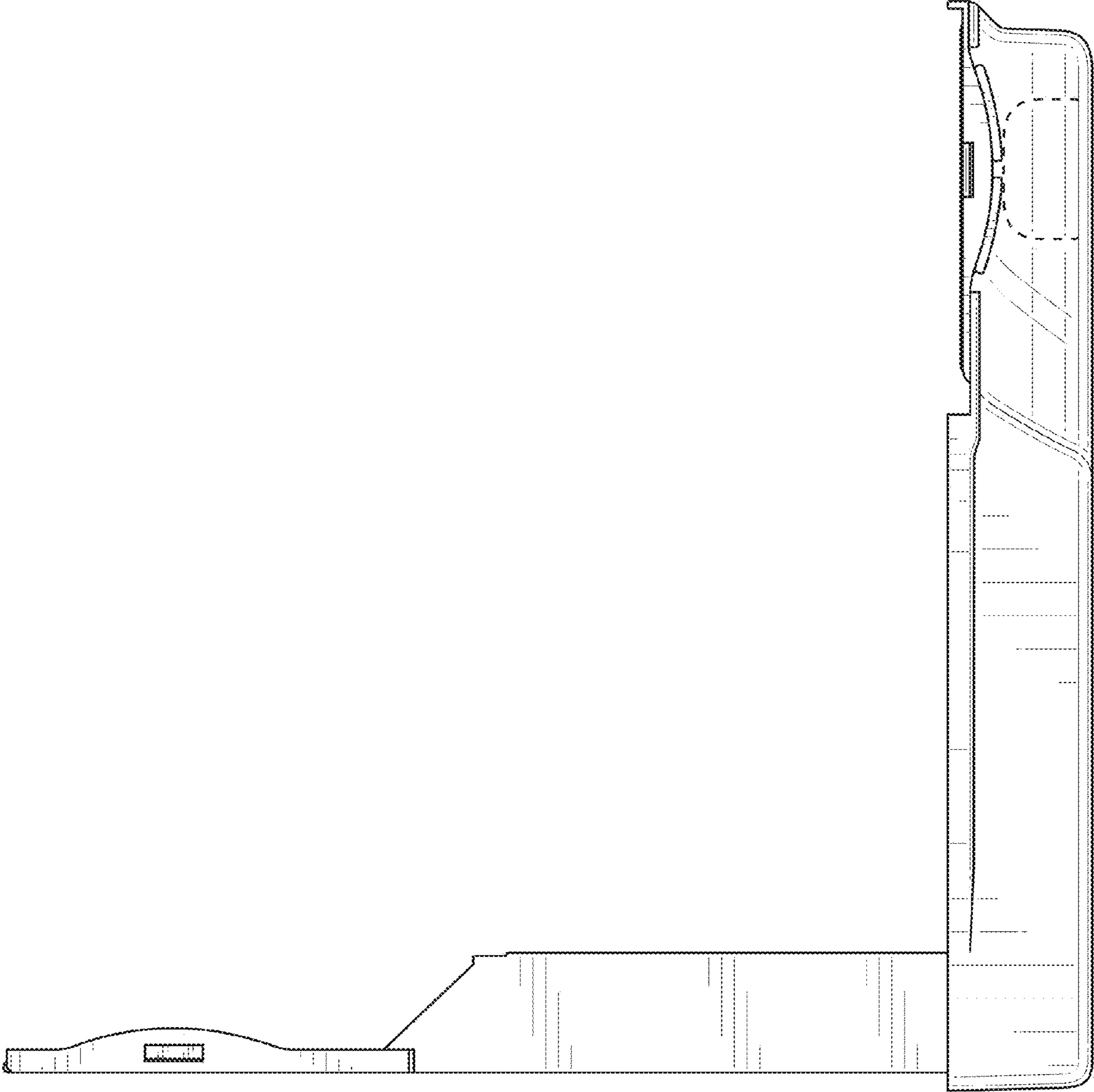

FIG. 4

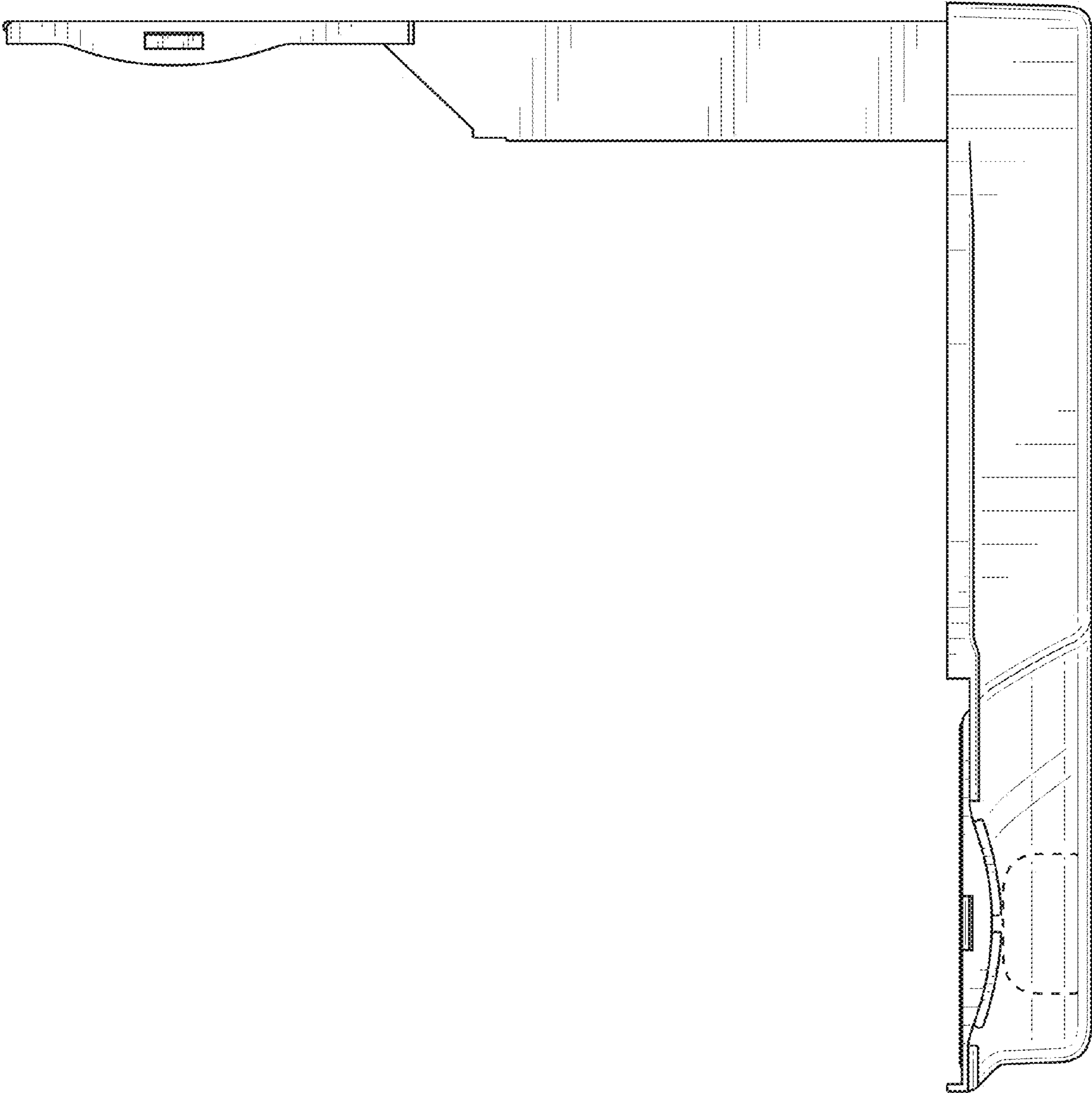

FIG. 5

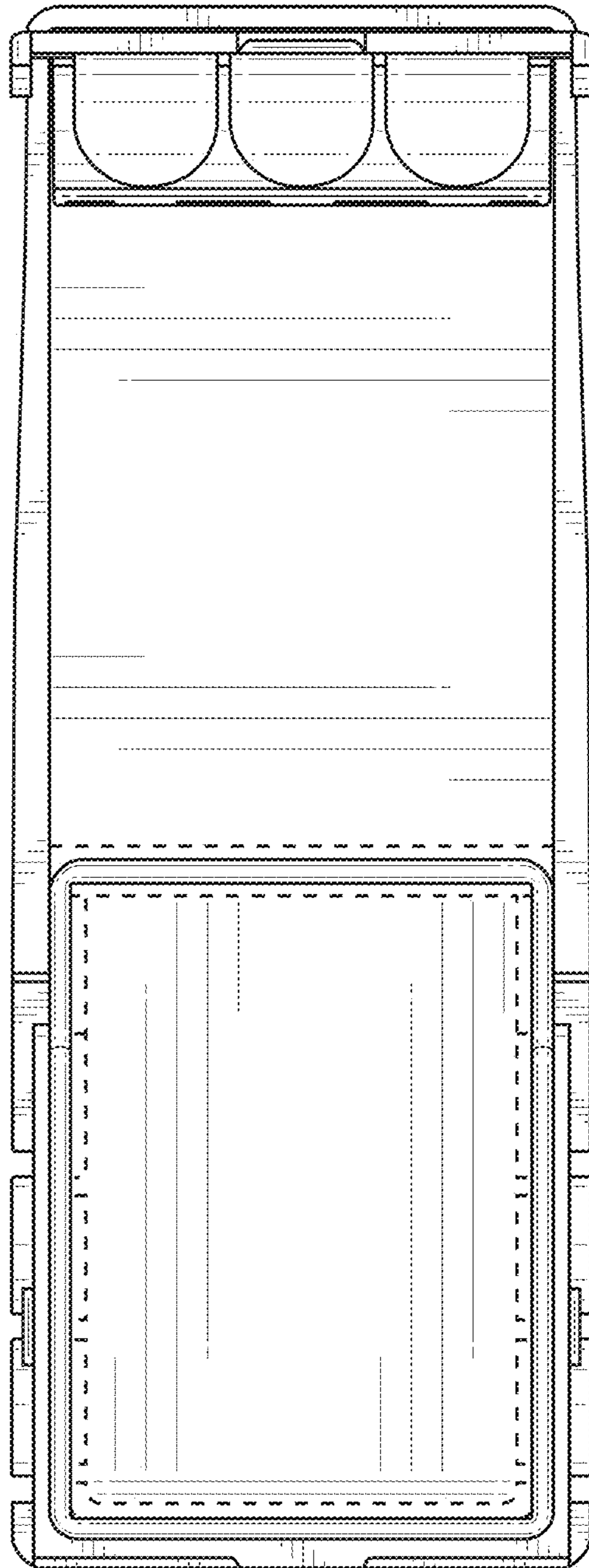

FIG. 6

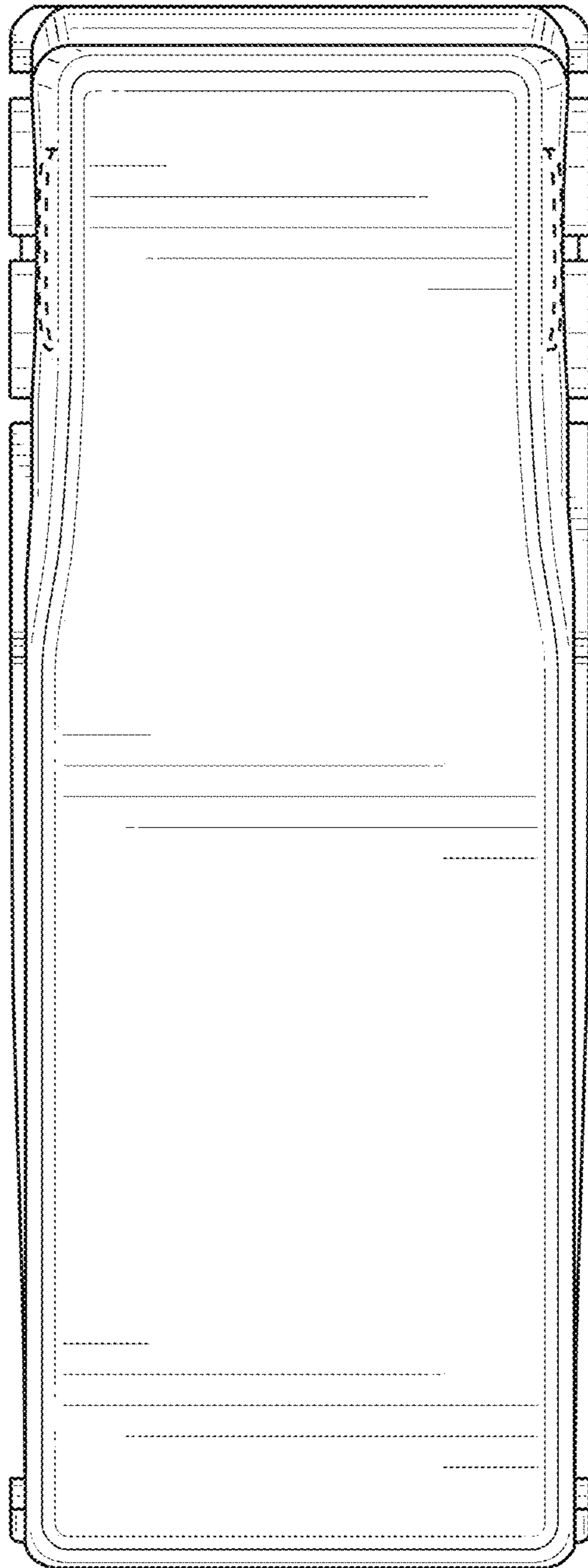

FIG. 7

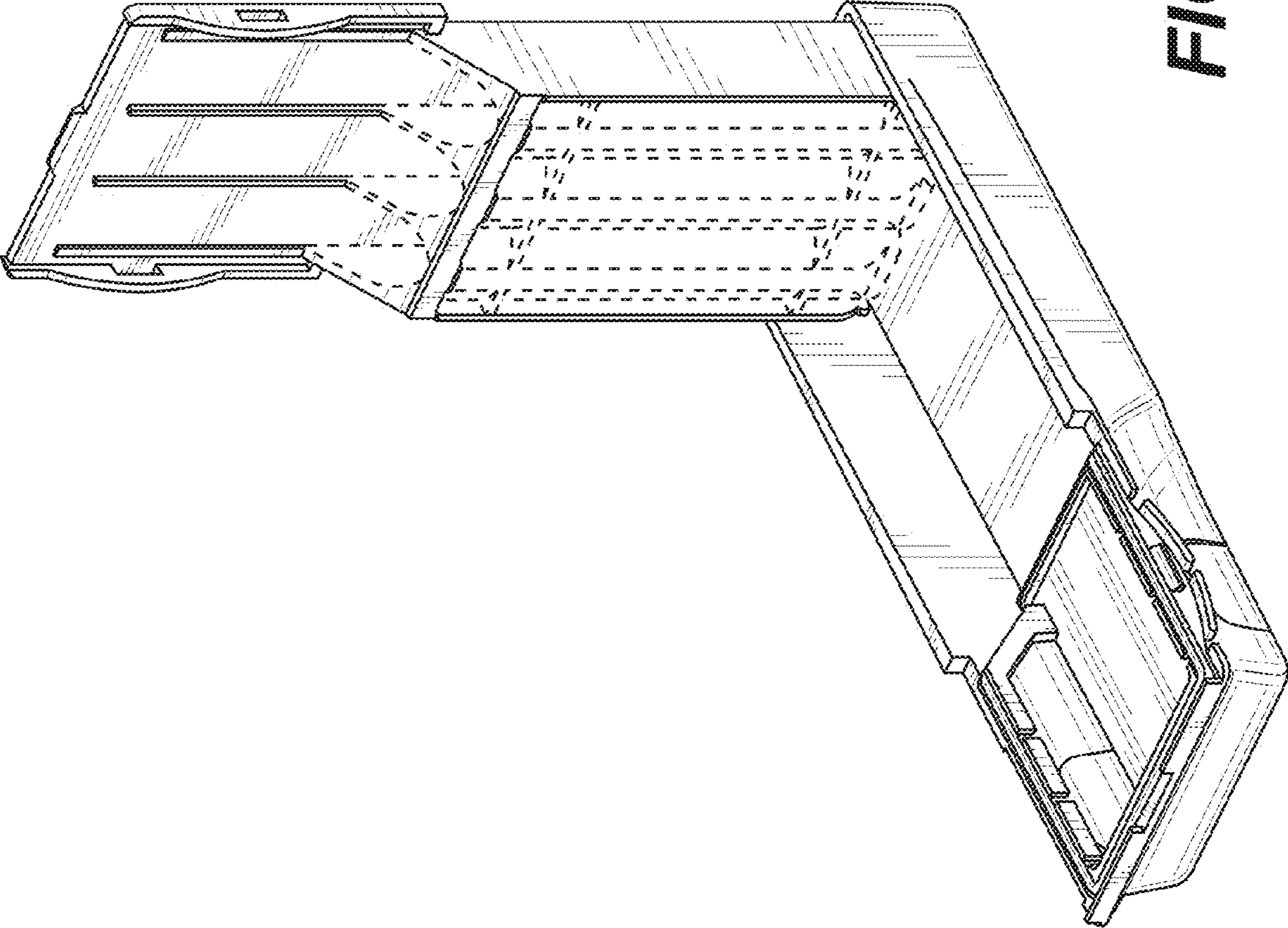

FIG. 8

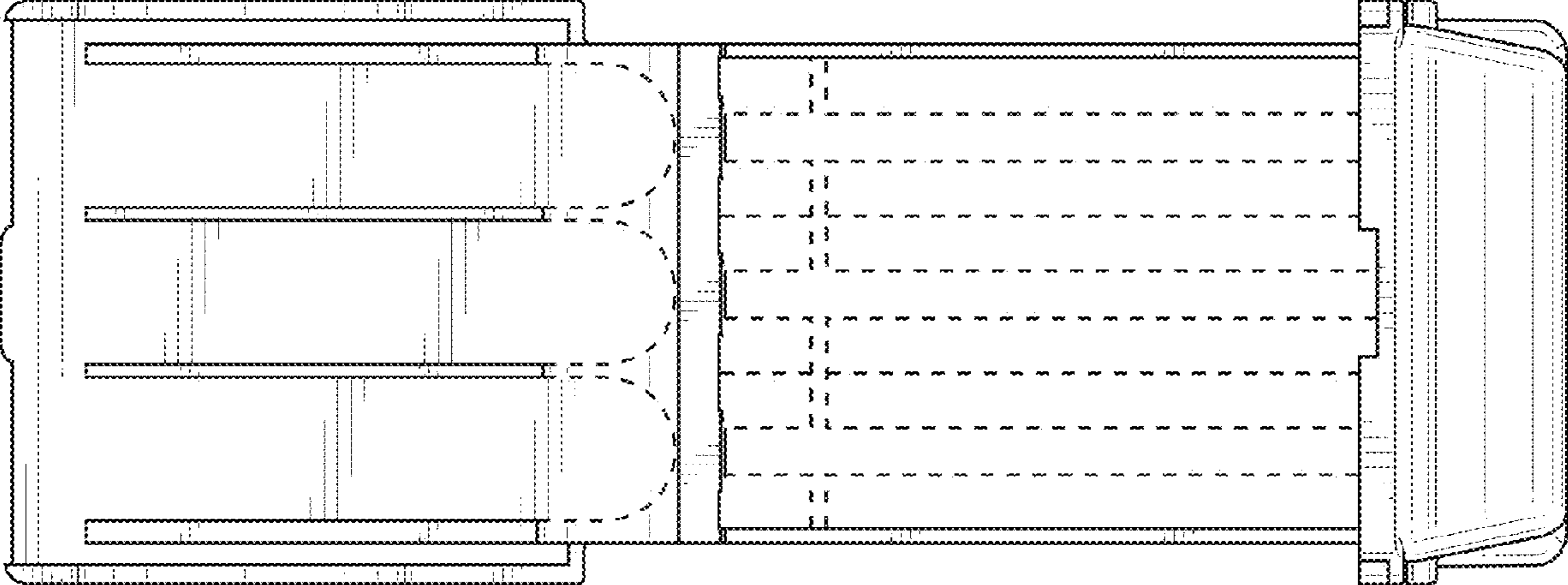

FIG. 9

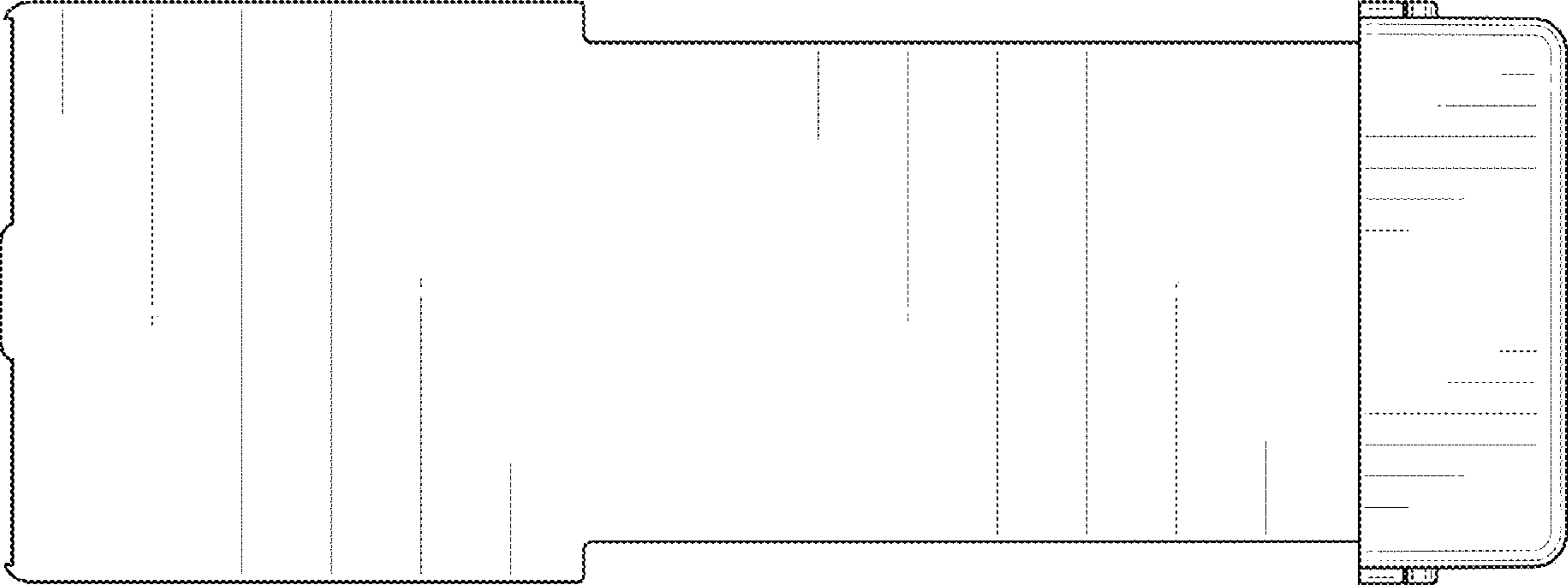

FIG. 10

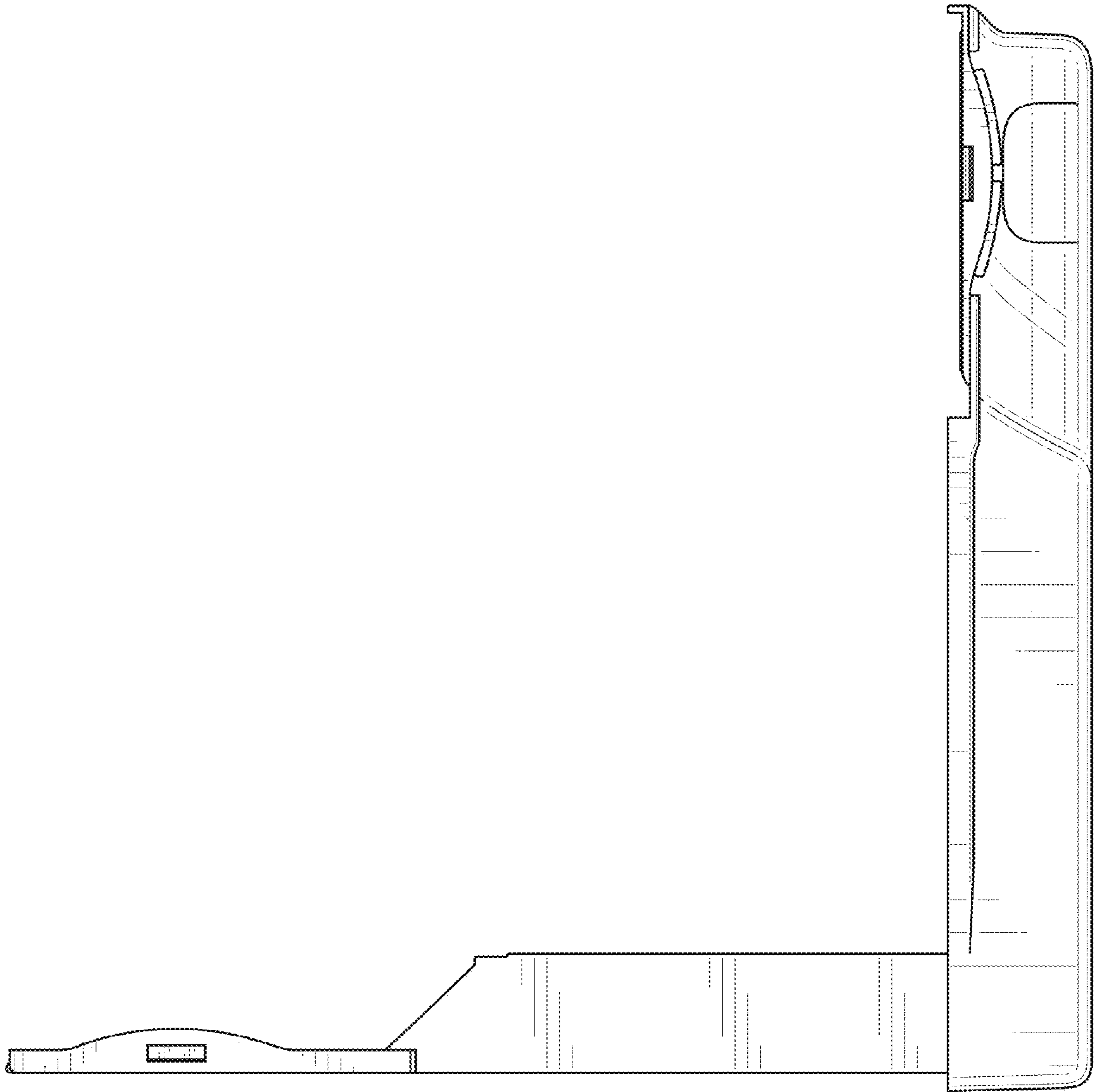

FIG. 11

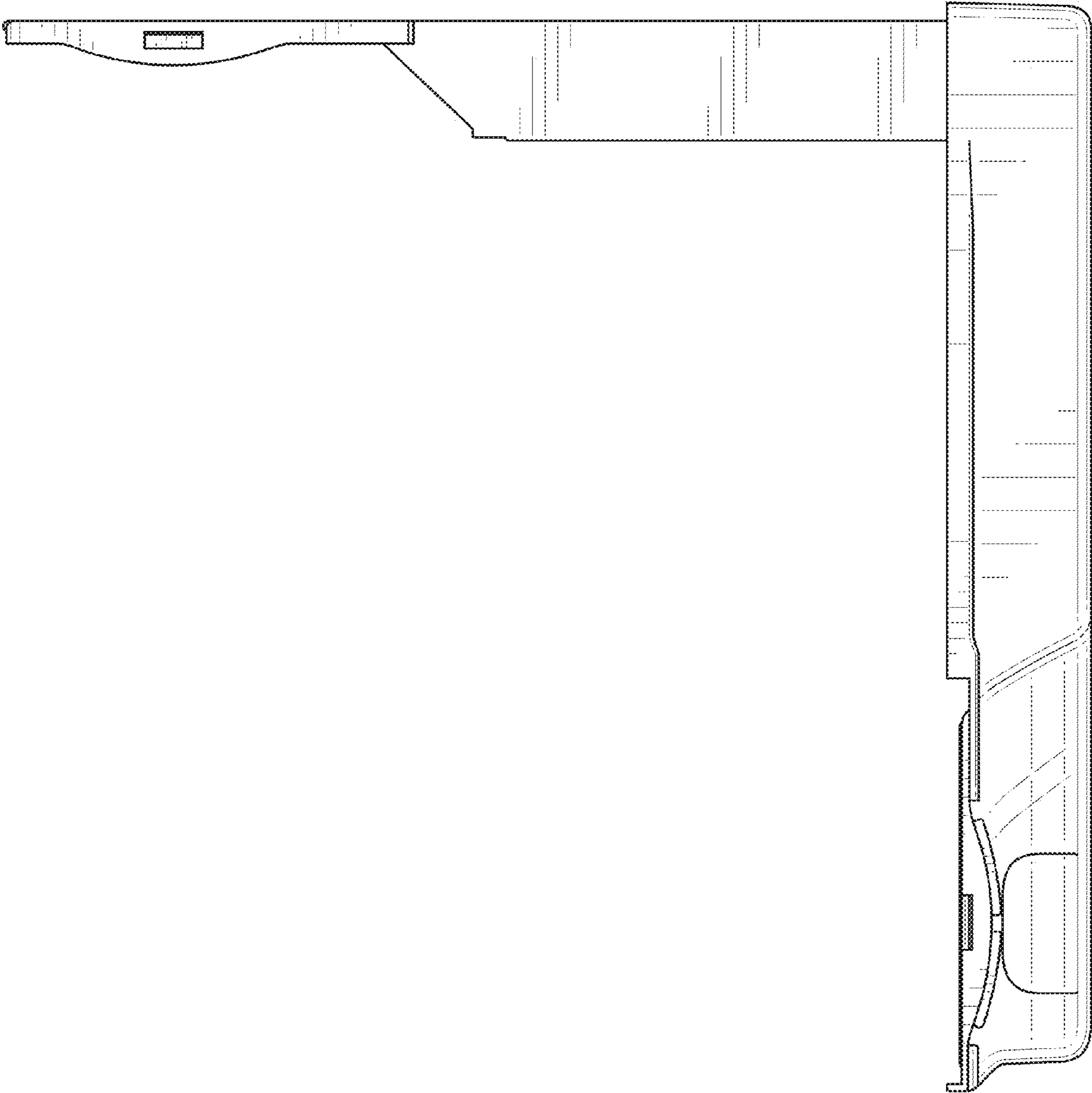

FIG. 12

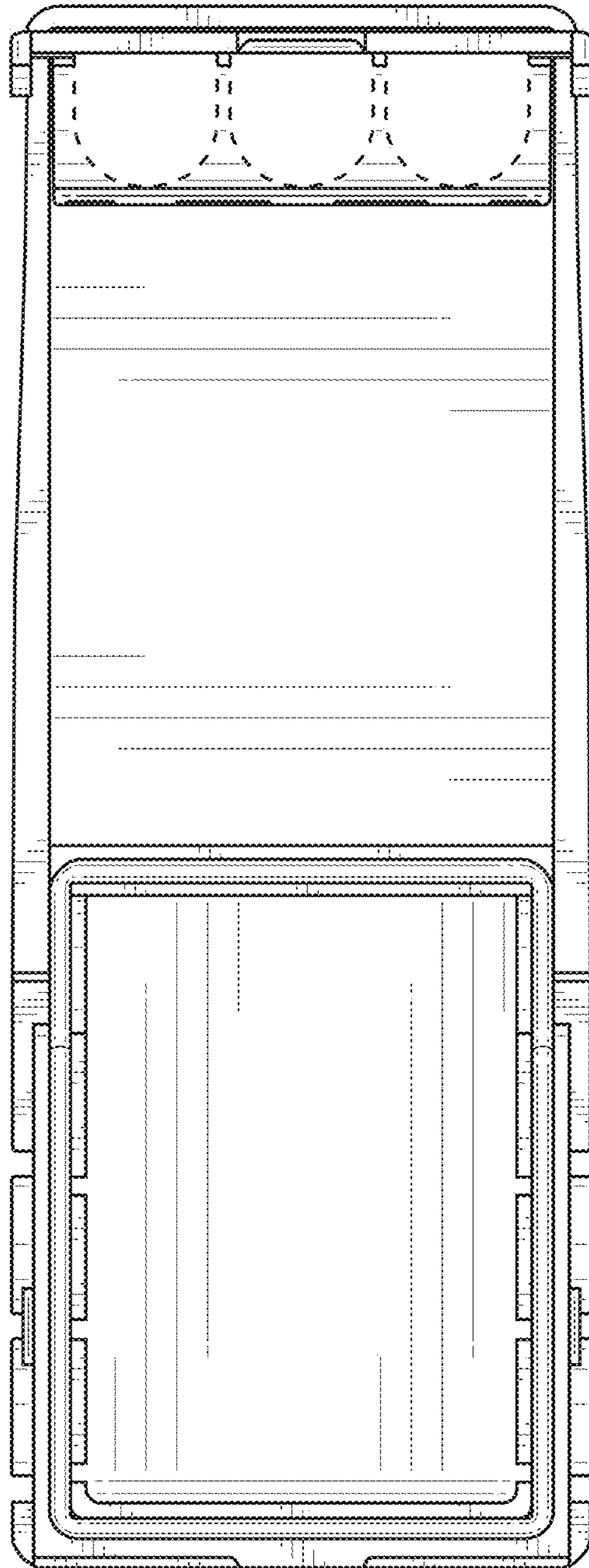

FIG. 13

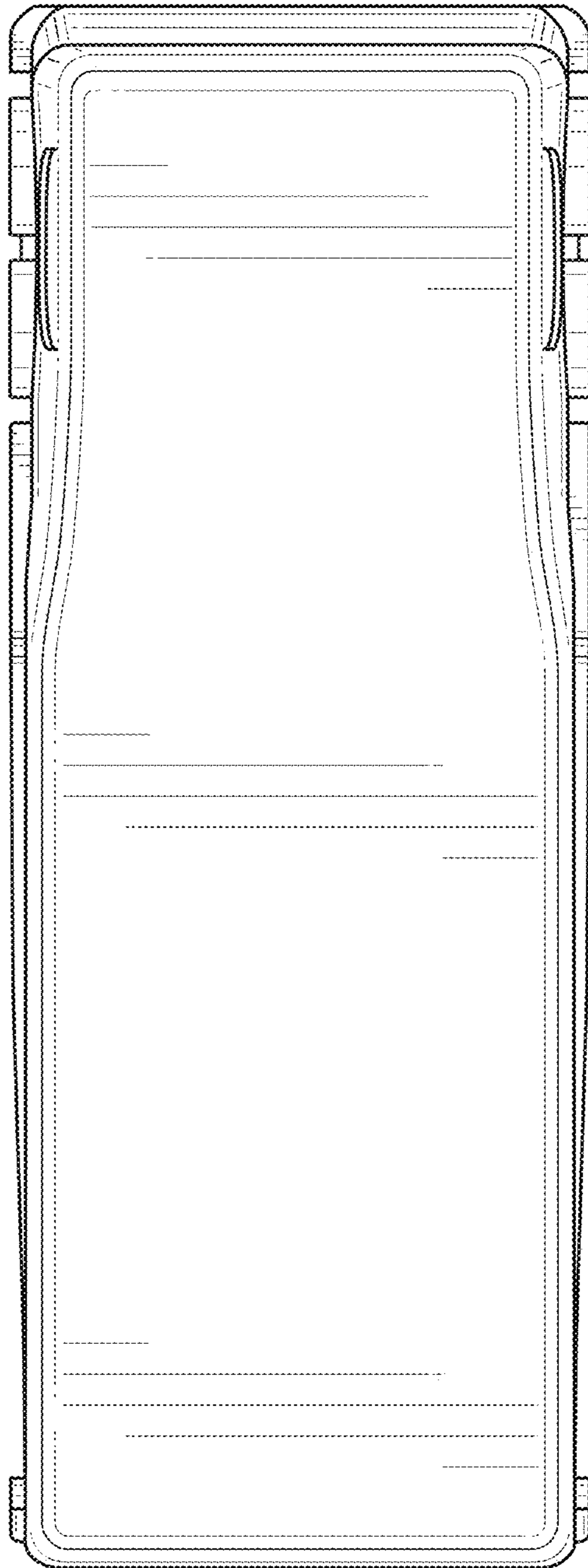

FIG. 14

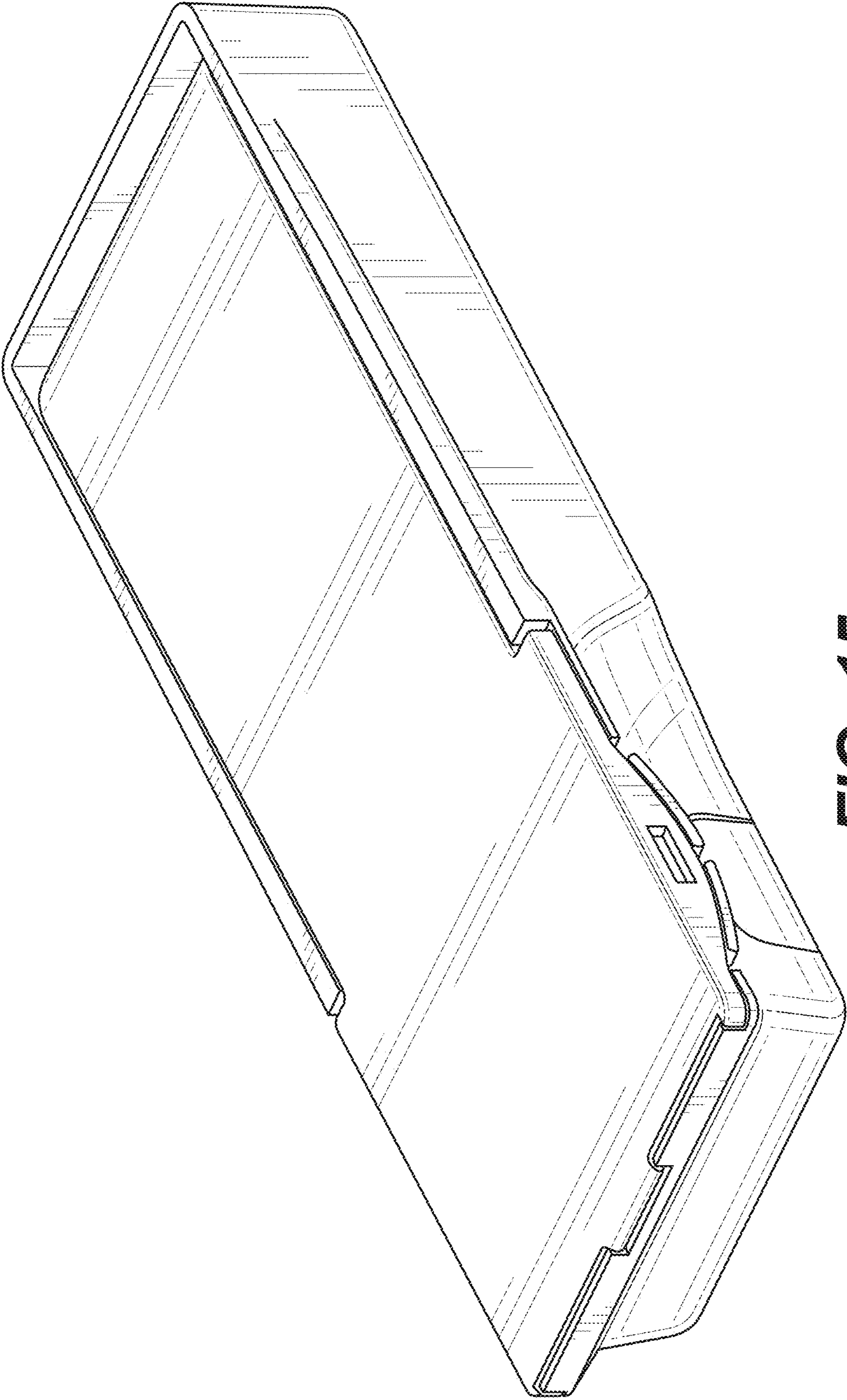

FIG. 15

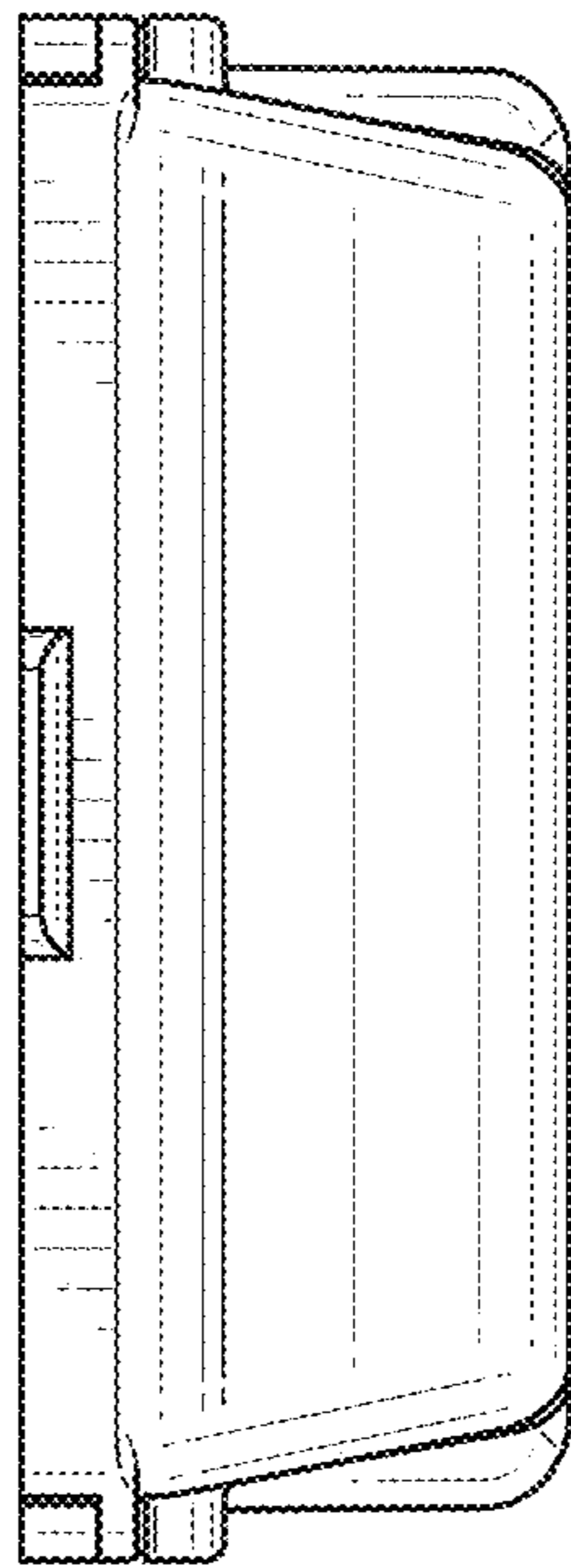

FIG. 16

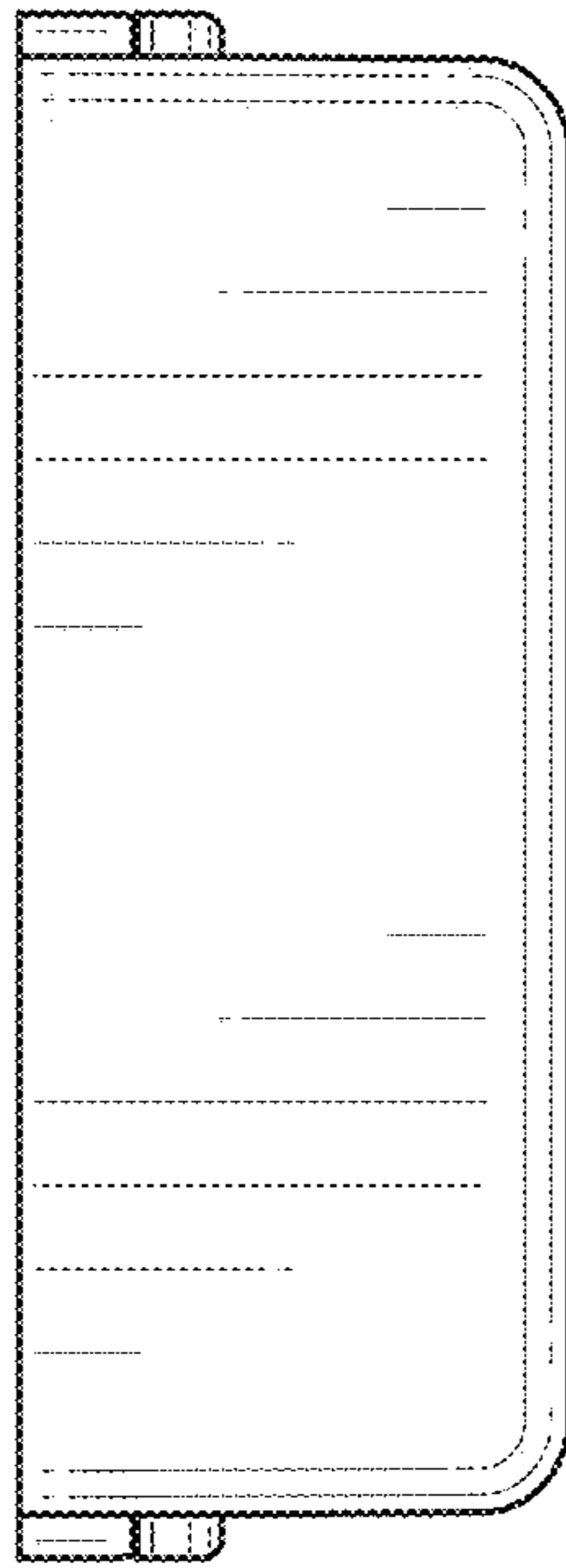

FIG. 17

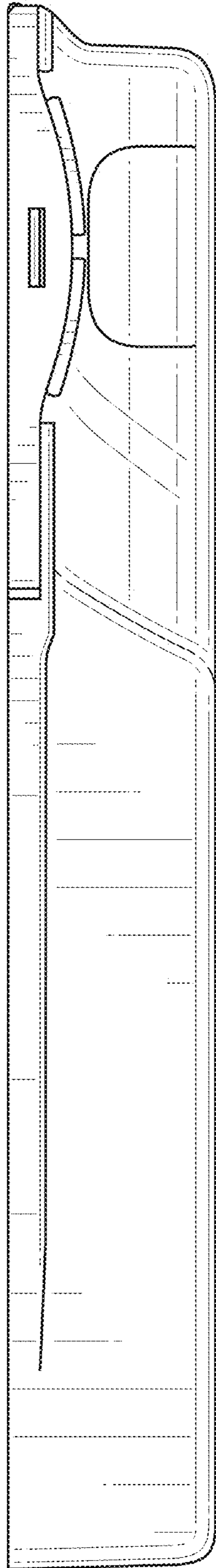

FIG. 18

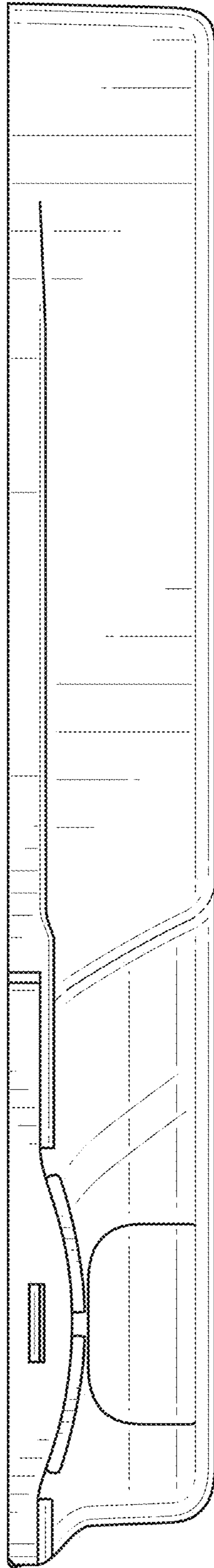

FIG. 19

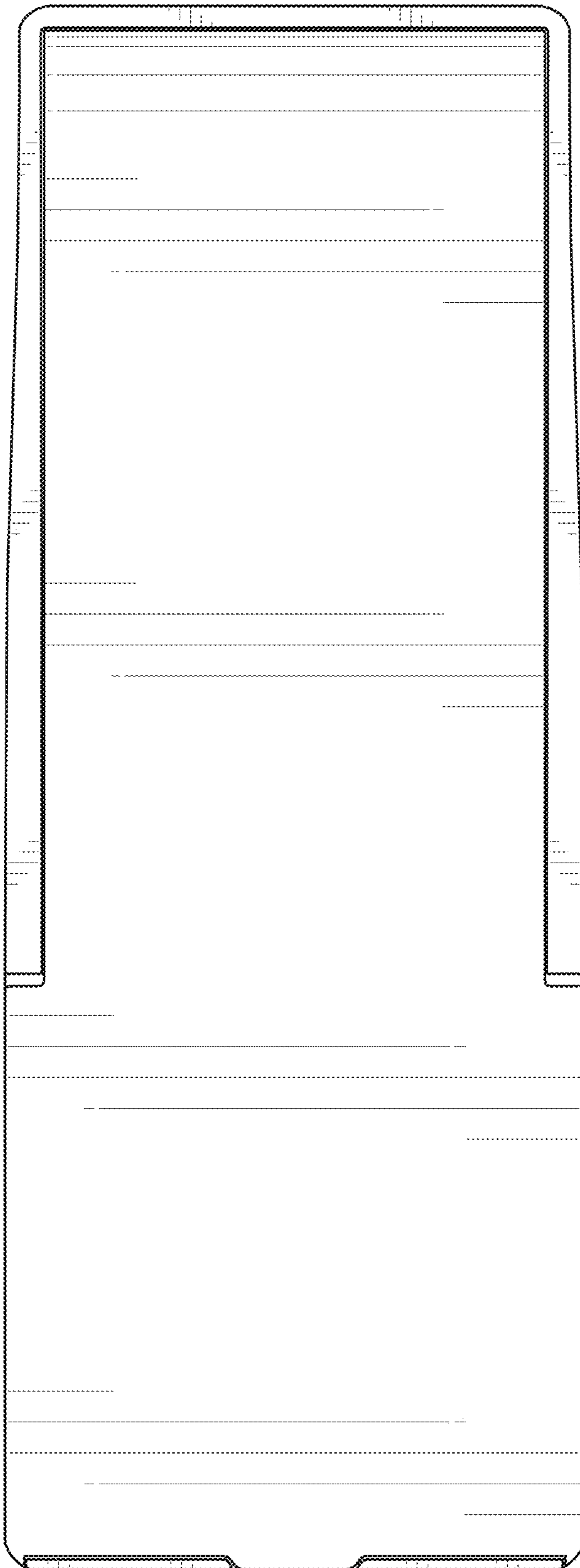

FIG. 20

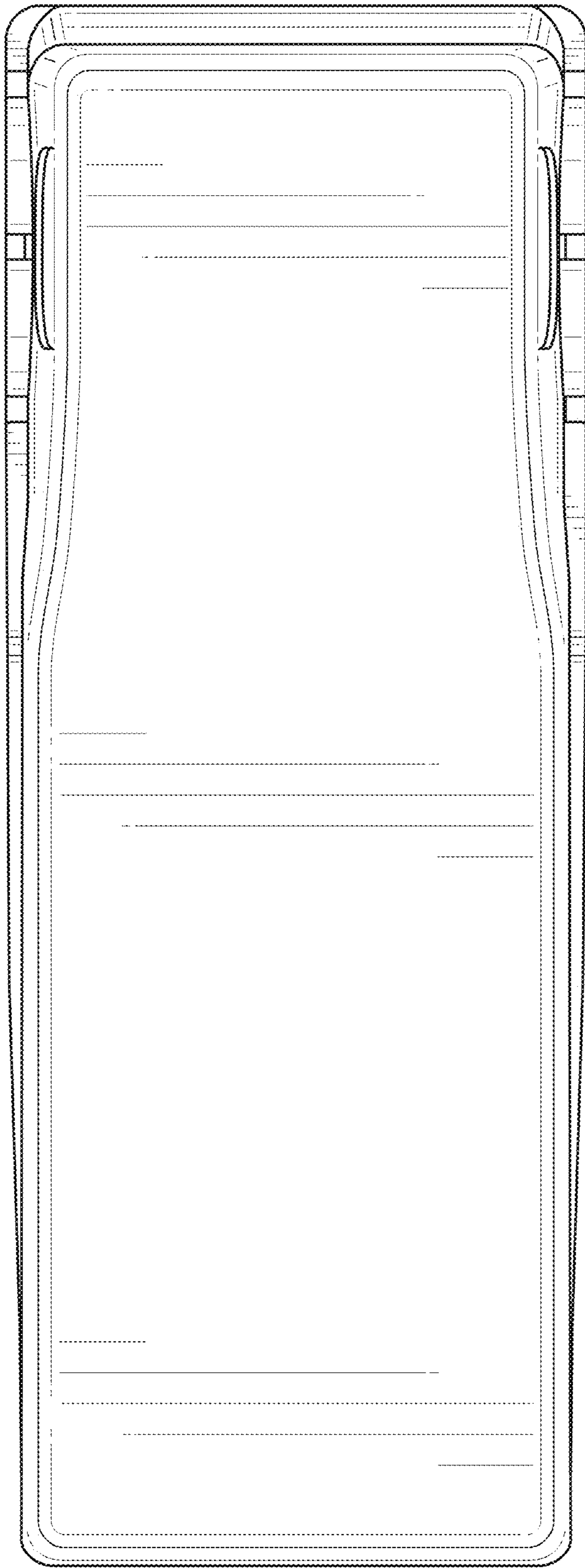

FIG. 21