



US00D922634S

(12) **United States Design Patent**
Qin

(10) **Patent No.:** **US D922,634 S**

(45) **Date of Patent:** **** Jun. 15, 2021**

(54) **DECORATIVE ROCK LIGHT**

(71) Applicant: **Qingguo Qin**, Guangxi (CN)

(72) Inventor: **Qingguo Qin**, Guangxi (CN)

(**) Term: **15 Years**

(21) Appl. No.: **29/759,557**

(22) Filed: **Nov. 24, 2020**

(51) **LOC (13) Cl.** **26-06**

(52) **U.S. Cl.**
USPC **D26/31**

(58) **Field of Classification Search**
USPC D26/28–36, 139
CPC F21S 48/00; F21S 48/10; F21S 48/115;
F21S 48/225; F21S 48/1233; F21S
48/1266; F21S 48/1388; F21S 48/2268;
F21V 5/00; F21V 21/04; F21V 29/004;
B60Q 9/13; B60Q 9/135; B60Q 9/1375
See application file for complete search history.

(56) **References Cited**

U.S. PATENT DOCUMENTS

D483,505 S	*	12/2003	Schwerdtmann	D26/28
D483,891 S	*	12/2003	Suberi	D26/31
D529,642 S	*	10/2006	Green	D26/31
D738,552 S	*	9/2015	Heiner	D26/31

D739,584 S	*	9/2015	Heiner	D26/31
D834,233 S		11/2018	Mishan et al.		
D867,639 S	*	11/2019	Dennis	D26/31

* cited by examiner

Primary Examiner — Marcus A Jackson

(57) **CLAIM**

The ornamental design for a decorative rock light, as shown and described.

DESCRIPTION

FIG. 1 is a perspective view of a decorative rock light showing my new design;
 FIG. 2 is a front elevational view thereof;
 FIG. 3 is a rear elevational view thereof;
 FIG. 4 is a left side elevational view thereof;
 FIG. 5 is a right side elevational view thereof;
 FIG. 6 is a top plan view thereof;
 FIG. 7 is a bottom plan view thereof; and,
 FIG. 8 is a perspective thereof, showing the decorative rock light in a state of use.
 The broken lines in the drawings depict portions of the decorative rock light that form no part of the claimed design, and the broken line showing of the line in FIG. 8 is for environmental purpose only and form no part of the claimed design.

1 Claim, 8 Drawing Sheets

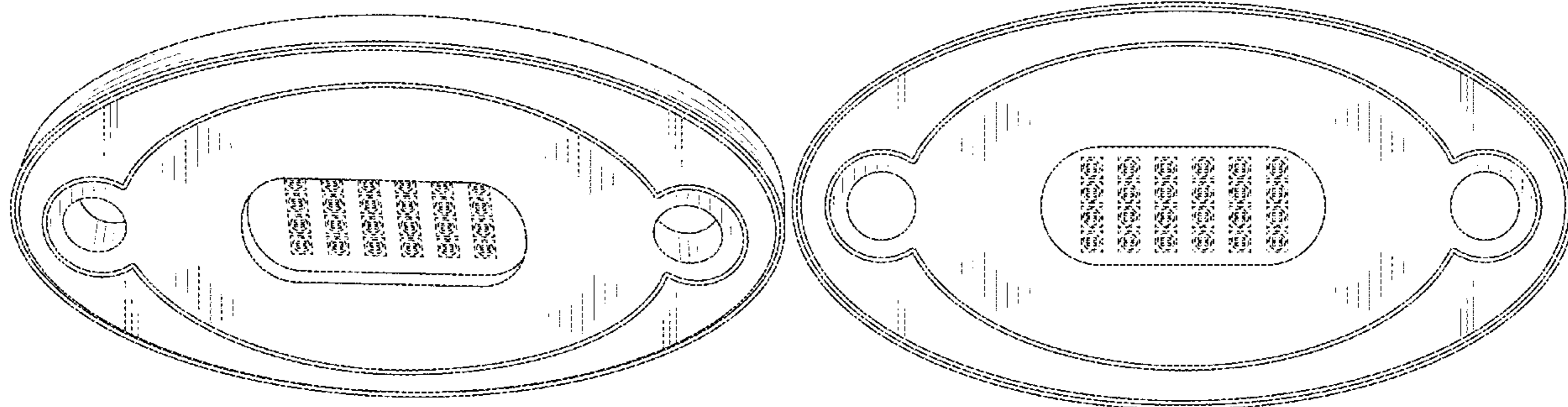

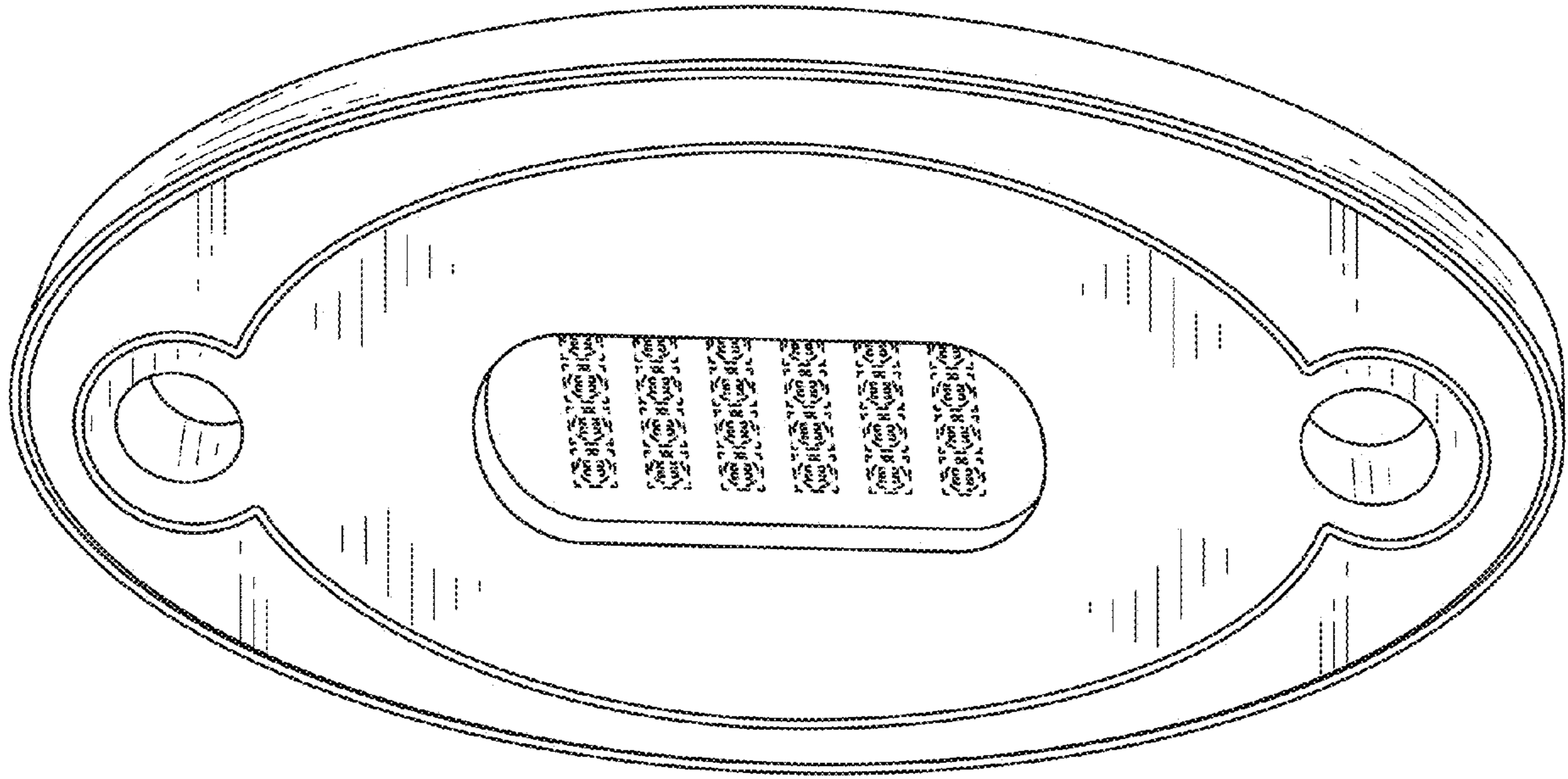

FIG. 1

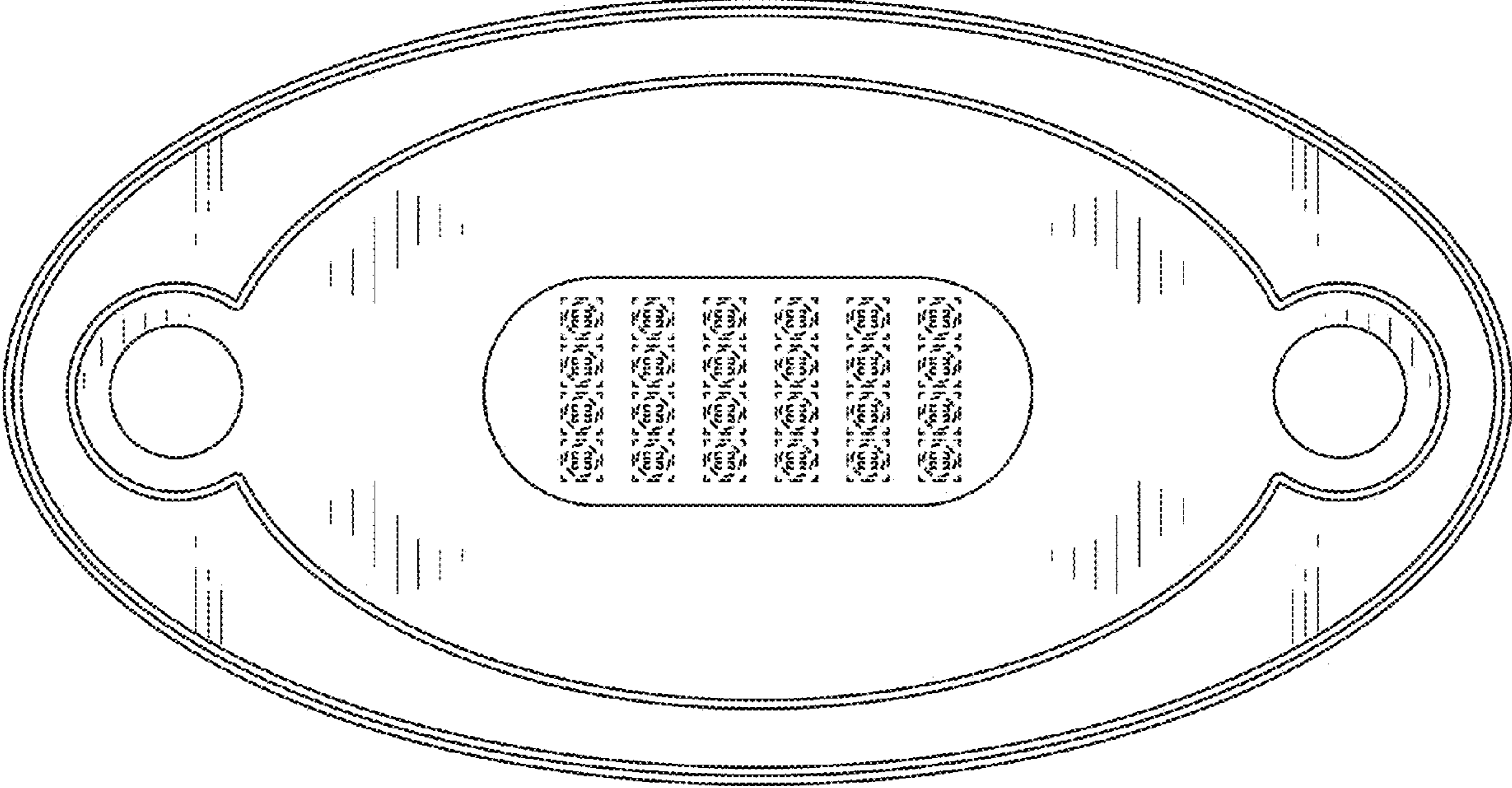

FIG. 2

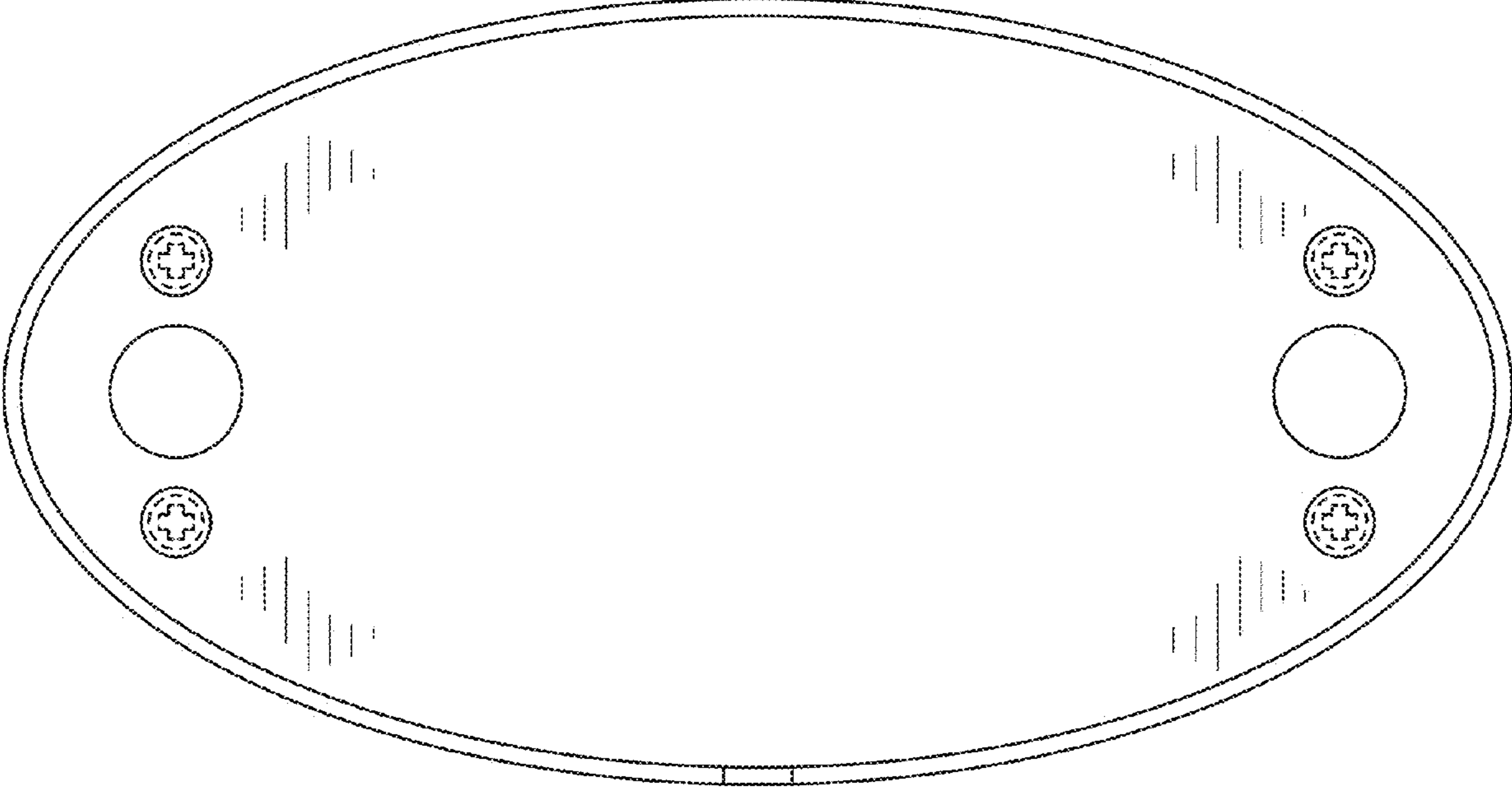

FIG. 3

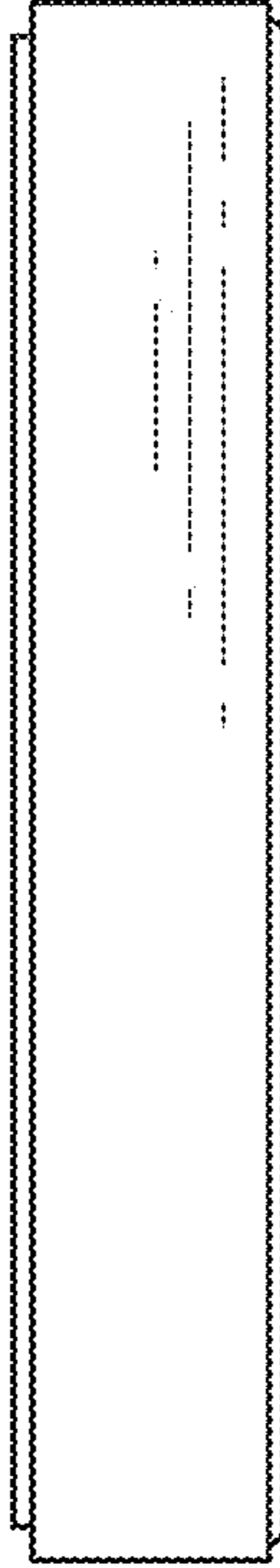

FIG. 4

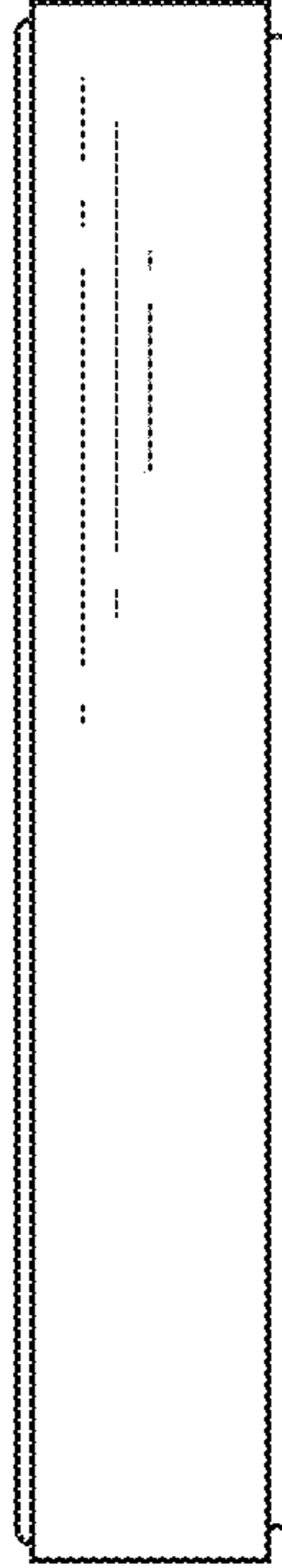

FIG. 5



FIG. 6

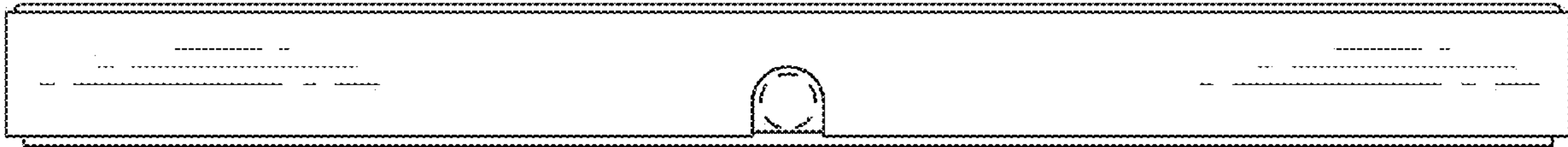

FIG. 7

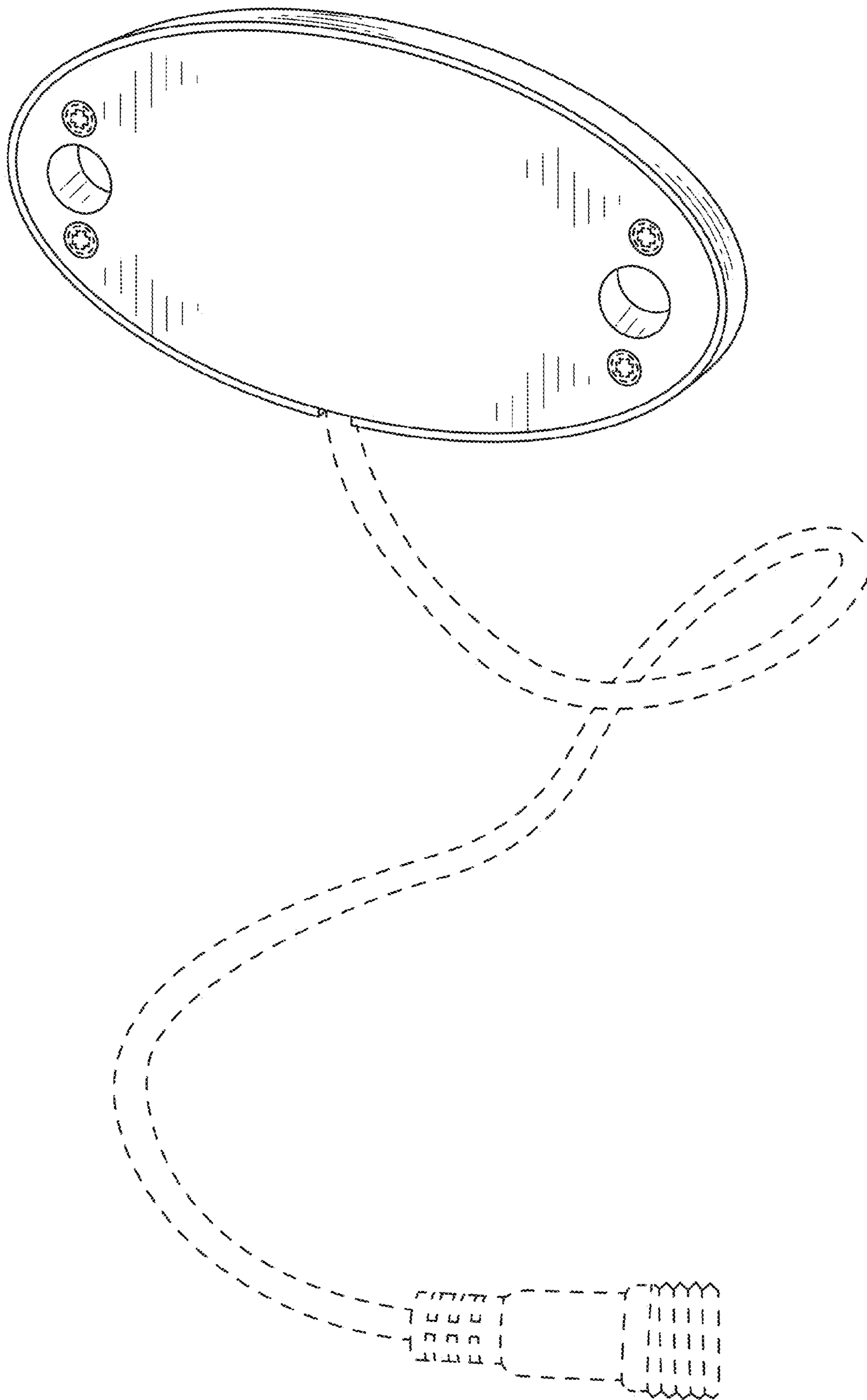

FIG. 8