



US00D922602S

(12) **United States Design Patent** (10) **Patent No.:** **US D922,602 S**
Fang et al. (45) **Date of Patent:** **** Jun. 15, 2021**

(54) **SALIVA TEST DEVICE**
(71) Applicants: **Zhejiang Orient Gene Biotech Co., Ltd.**, Anji Huzhou (CN); **Healgen Scientific Limited**, Houston, TX (US)
(72) Inventors: **Jianqiu Fang**, Anji Huzhou (CN); **Siyu Lei**, Anji Huzhou (CN); **Lili Shen**, Anji Huzhou (CN)
(73) Assignees: **Zhejiang Orient Gene Biotech Co., Ltd.**, Zhejiang (CN); **Healgen Scientific Limited**, Houston, TX (US)
(**) Term: **15 Years**

D561,344 S * 2/2008 Kozak D24/216
D631,169 S * 1/2011 Cheeley D24/224
D678,516 S * 3/2013 Wong D24/121
D778,460 S * 2/2017 Marechal D24/224
D790,726 S * 6/2017 Plante D24/224
D831,196 S * 10/2018 Fang D24/121
D842,494 S * 3/2019 Lee D24/224
D864,774 S * 10/2019 Lei D10/81
D901,696 S * 11/2020 Lei D24/186
2012/0308448 A1 * 12/2012 Wong B01L 3/50825
422/558
2015/0250456 A1 * 9/2015 Olgun A61B 10/007
422/548
2017/0151557 A1 * 6/2017 Lei A61B 10/0096
2018/0011078 A1 * 1/2018 Lei G01N 33/48778
2019/0092555 A1 * 3/2019 Ma B01L 3/50851
2020/0100774 A1 * 4/2020 Lei A61B 5/150022

* cited by examiner

(21) Appl. No.: **29/709,339**
(22) Filed: **Oct. 14, 2019**
(30) **Foreign Application Priority Data**

Primary Examiner — Anhdao Doan
(74) *Attorney, Agent, or Firm* — Thomas Horstemeyer, LLP

Apr. 18, 2019 (CN) 201930178945.6
(51) **LOC (13) Cl.** **24-01**
(52) **U.S. Cl.**
USPC **D24/216**
(58) **Field of Classification Search**
USPC D24/216, 223–233, 186, 107, 121;
D10/81
CPC B01L 3/5029; B01L 3/508; B01L 3/5082;
B01L 3/50825; B01L 2300/046; B01L
2300/047; B01L 2300/049; B01L
2300/0832; A61B 10/0051; A61B 10/007;
A61B 10/0074; A61B 10/0038; A61B
10/0096
See application file for complete search history.

(57) **CLAIM**

The ornamental design for a saliva test device, as shown and described.

DESCRIPTION

FIG. 1 is a top view of an embodiment of the saliva test device according to the present design;
FIG. 2 is a bottom view of the saliva test device of FIG. 1;
FIG. 3 is a rear view of the saliva test device of FIG. 1;
FIG. 4 is a front view of the saliva test device of FIG. 1;
FIG. 5 is a left view of the saliva test device of FIG. 1;
FIG. 6 is a right view of the saliva test device of FIG. 1;
FIG. 7 is a top perspective view of the saliva test device of FIG. 1; and,
FIG. 8 is a bottom perspective view of the saliva test device of FIG. 1.

(56) **References Cited**
U.S. PATENT DOCUMENTS

D507,351 S * 7/2005 Birnboim D24/216
D520,643 S * 5/2006 Clarke D24/216

1 Claim, 8 Drawing Sheets

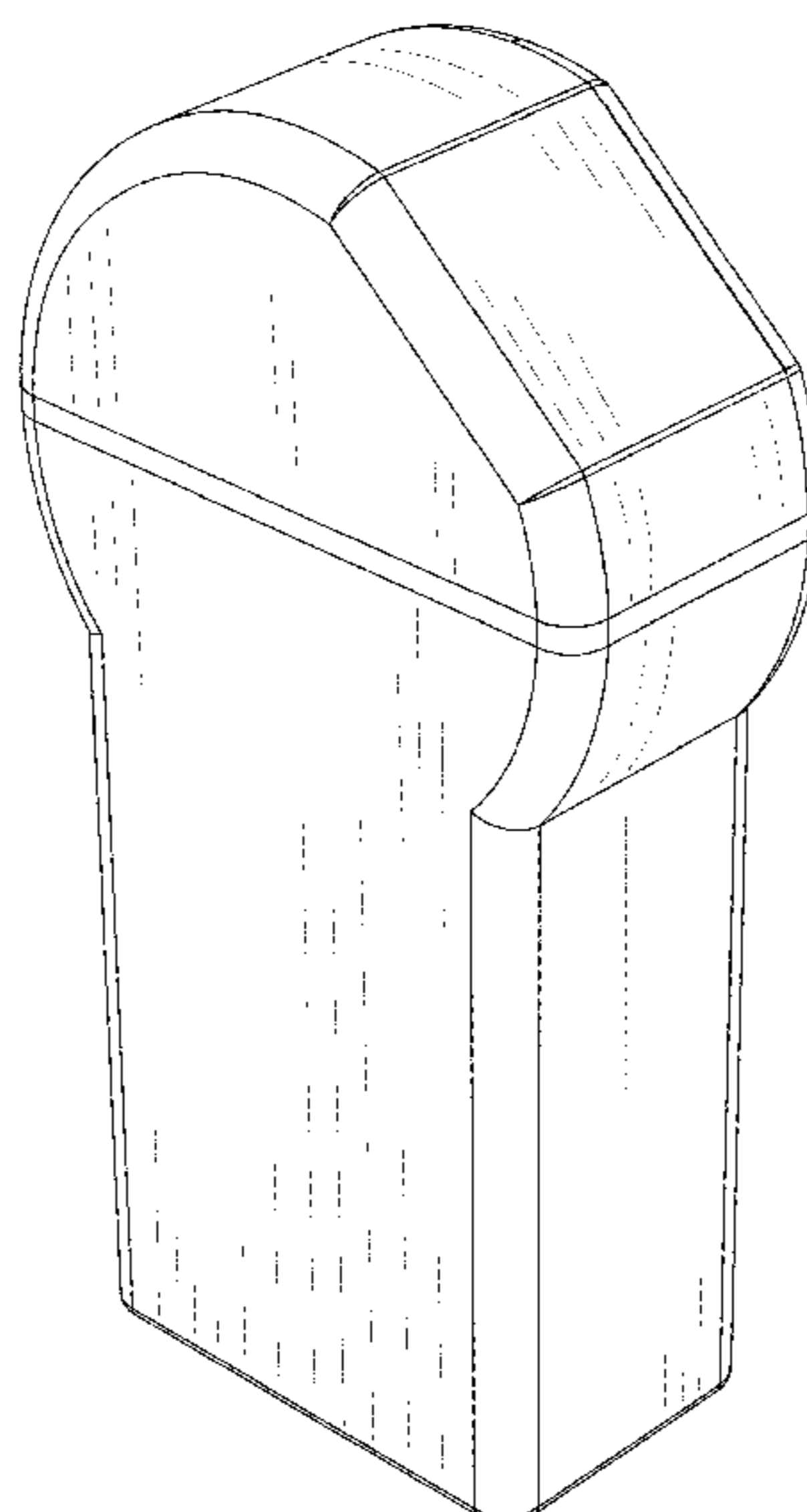

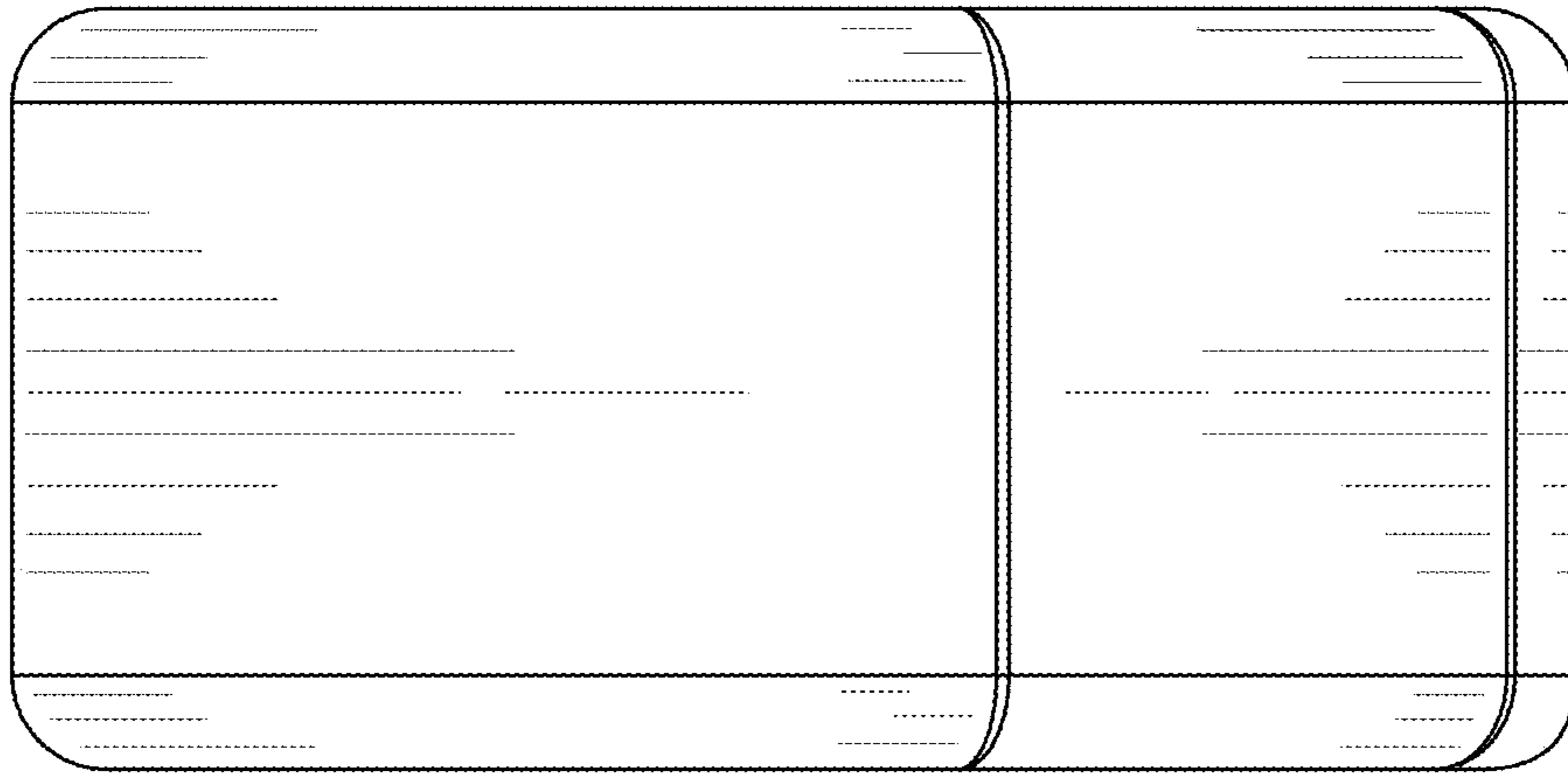

Fig. 1

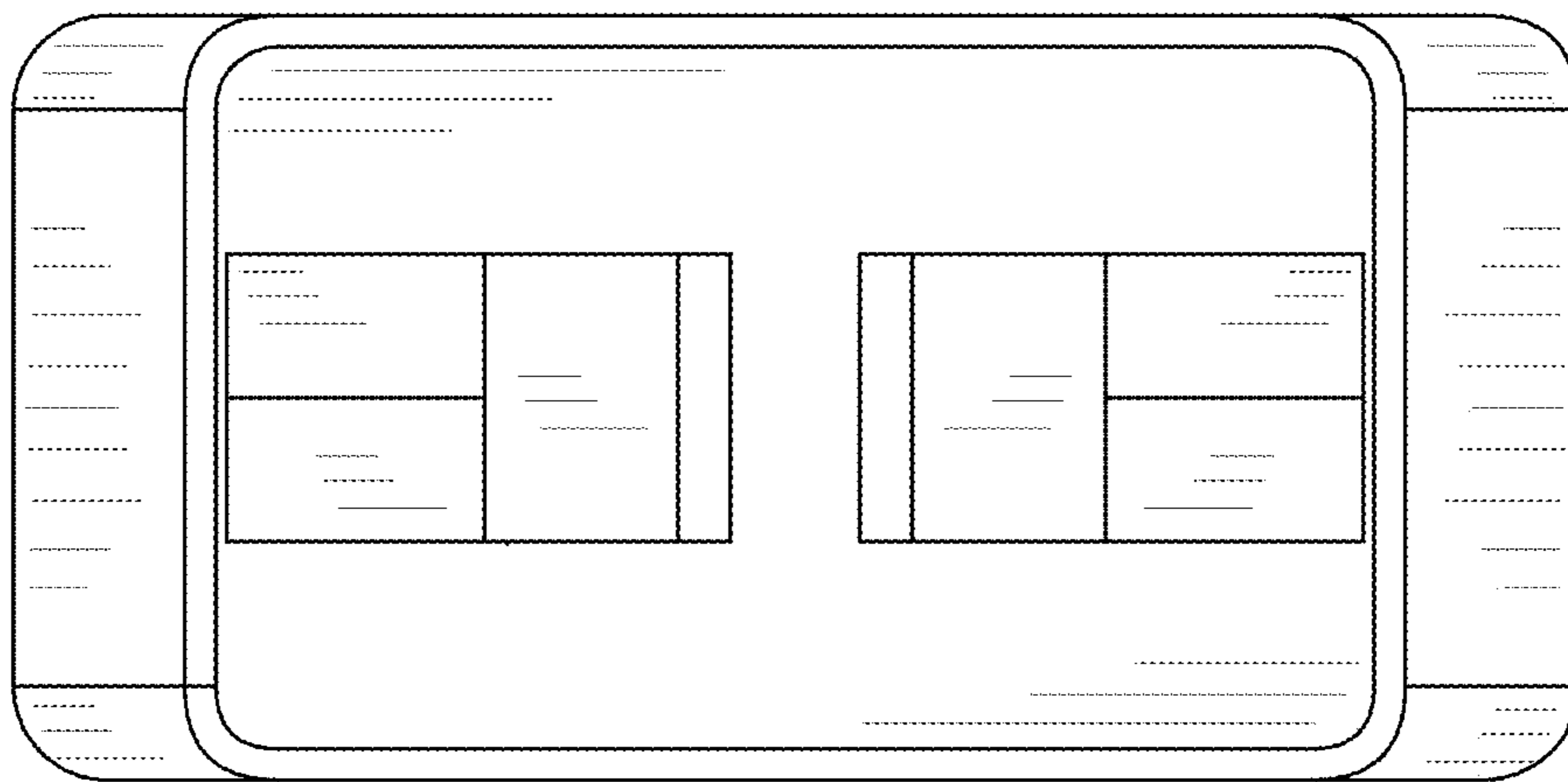

Fig. 2

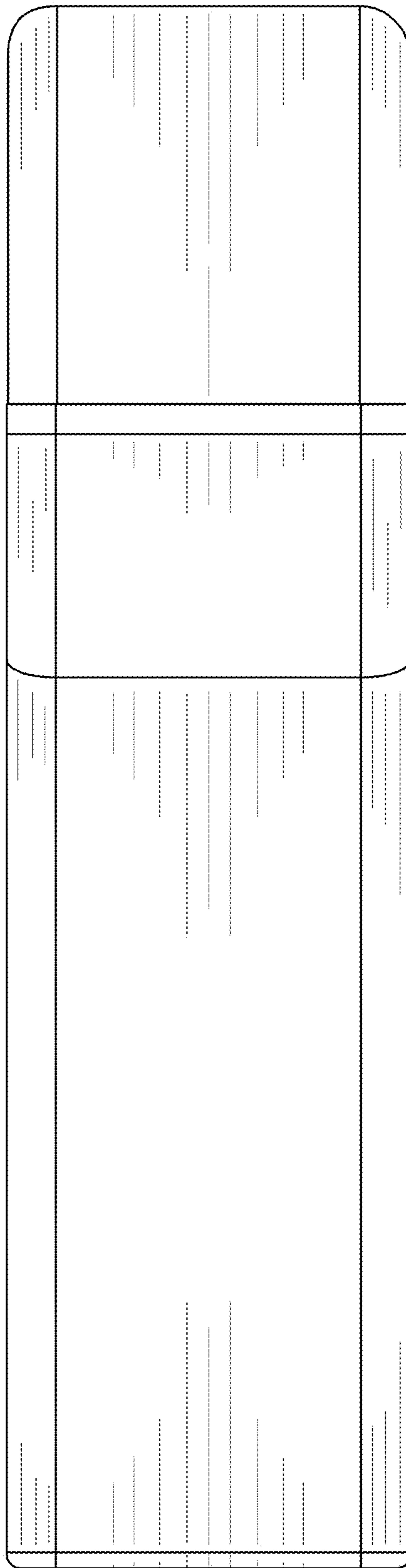

Fig. 3

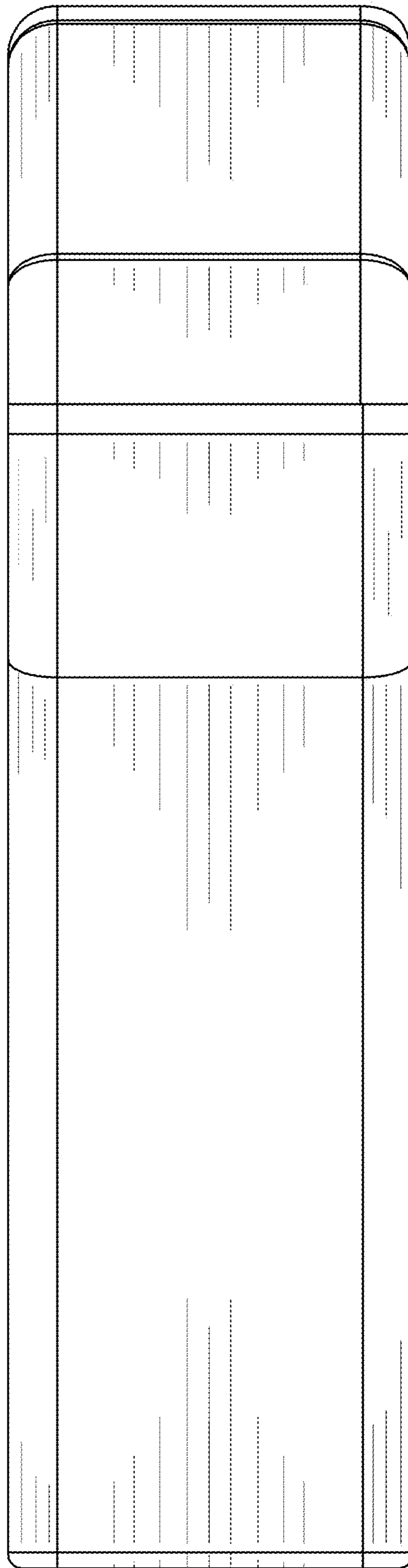

Fig. 4

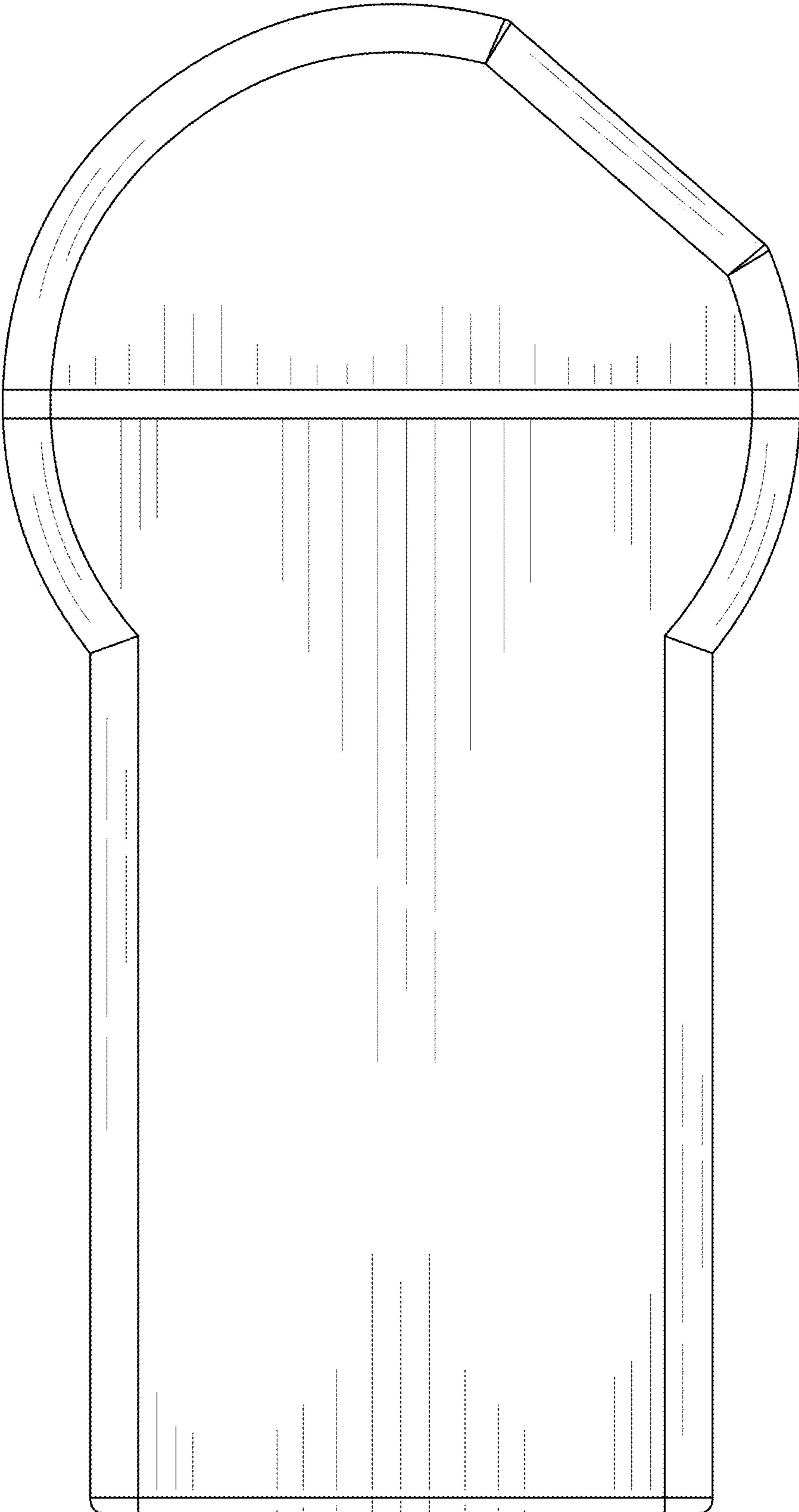

Fig. 5

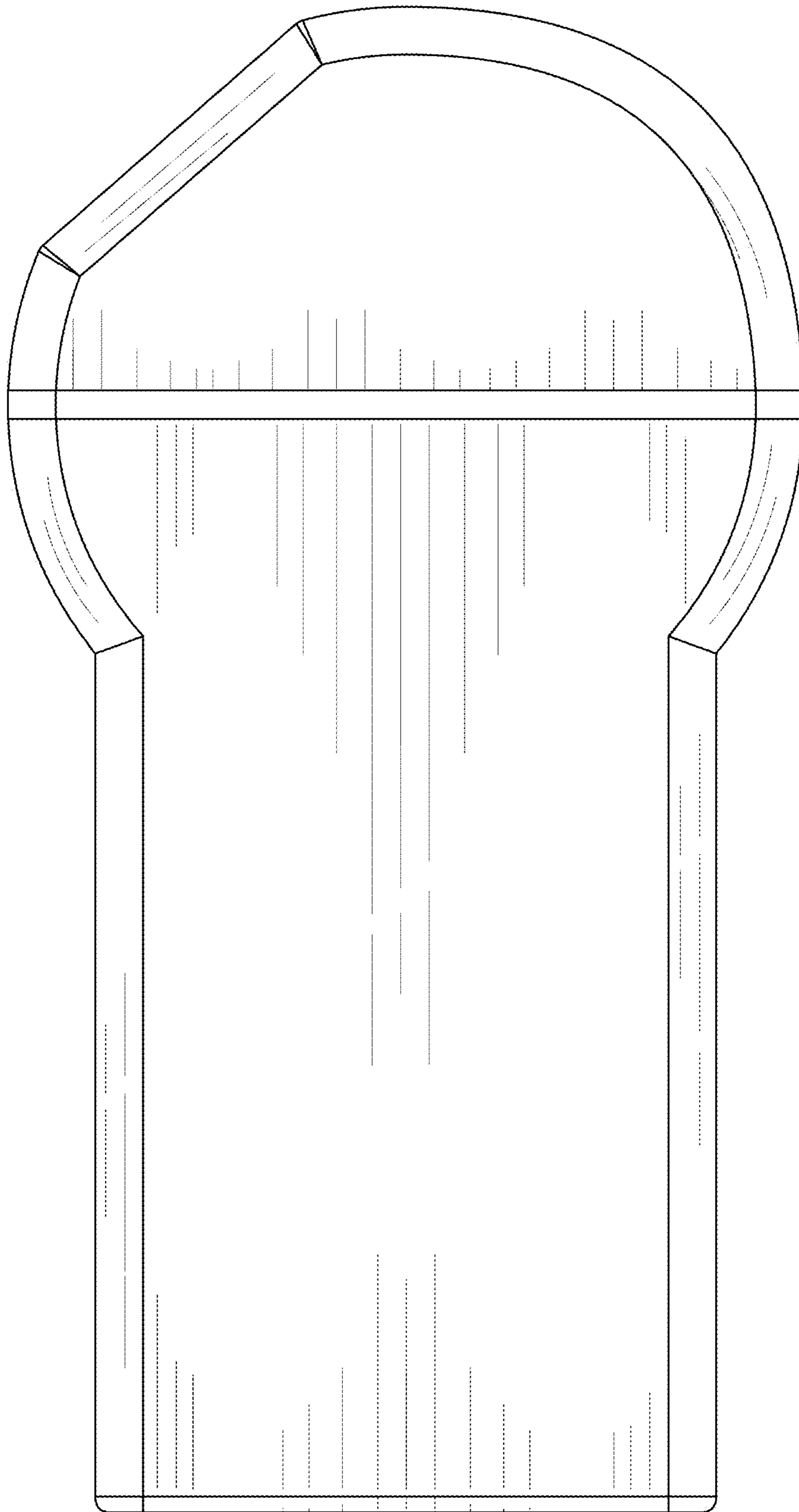

Fig. 6

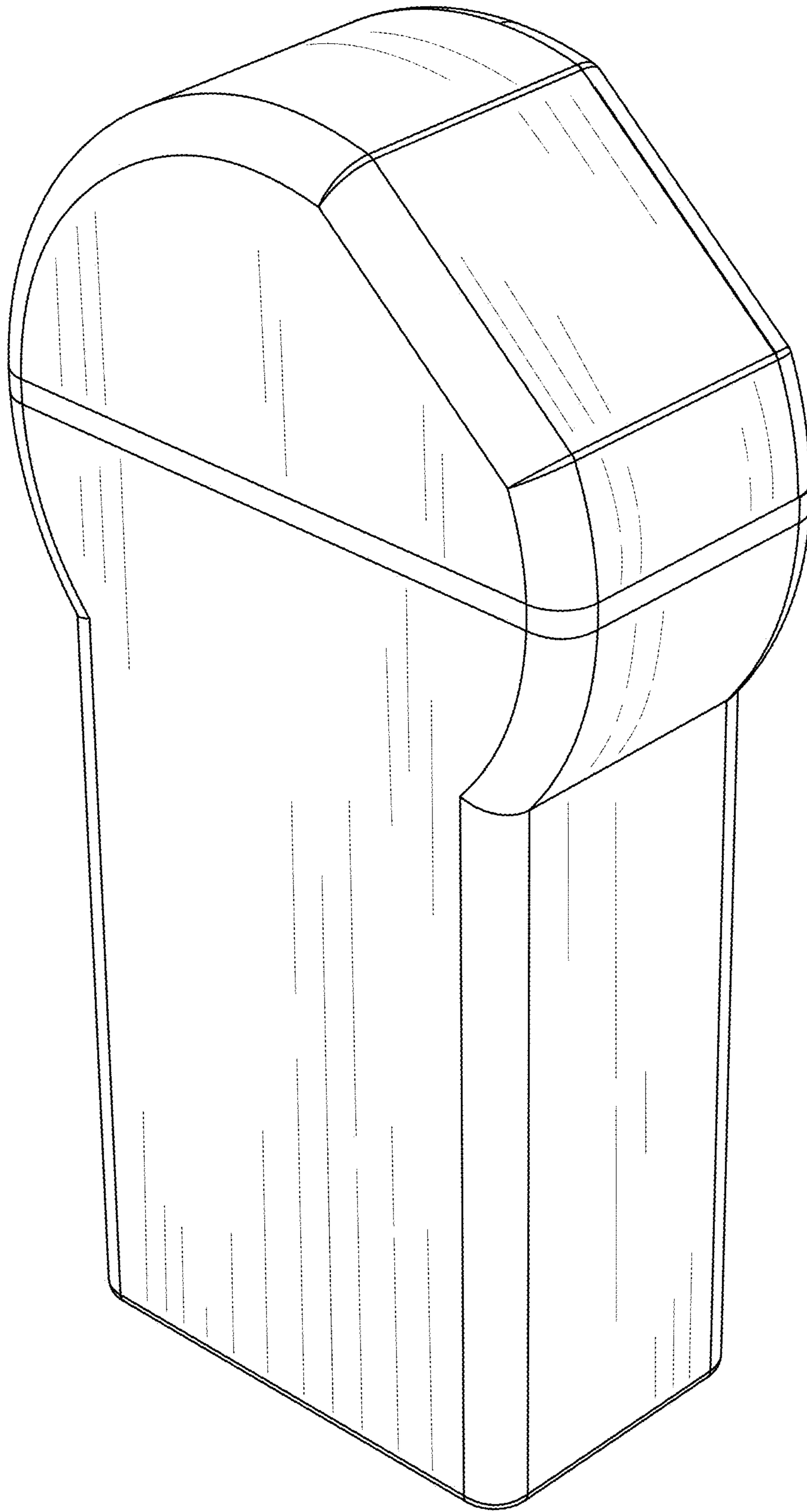

Fig. 7

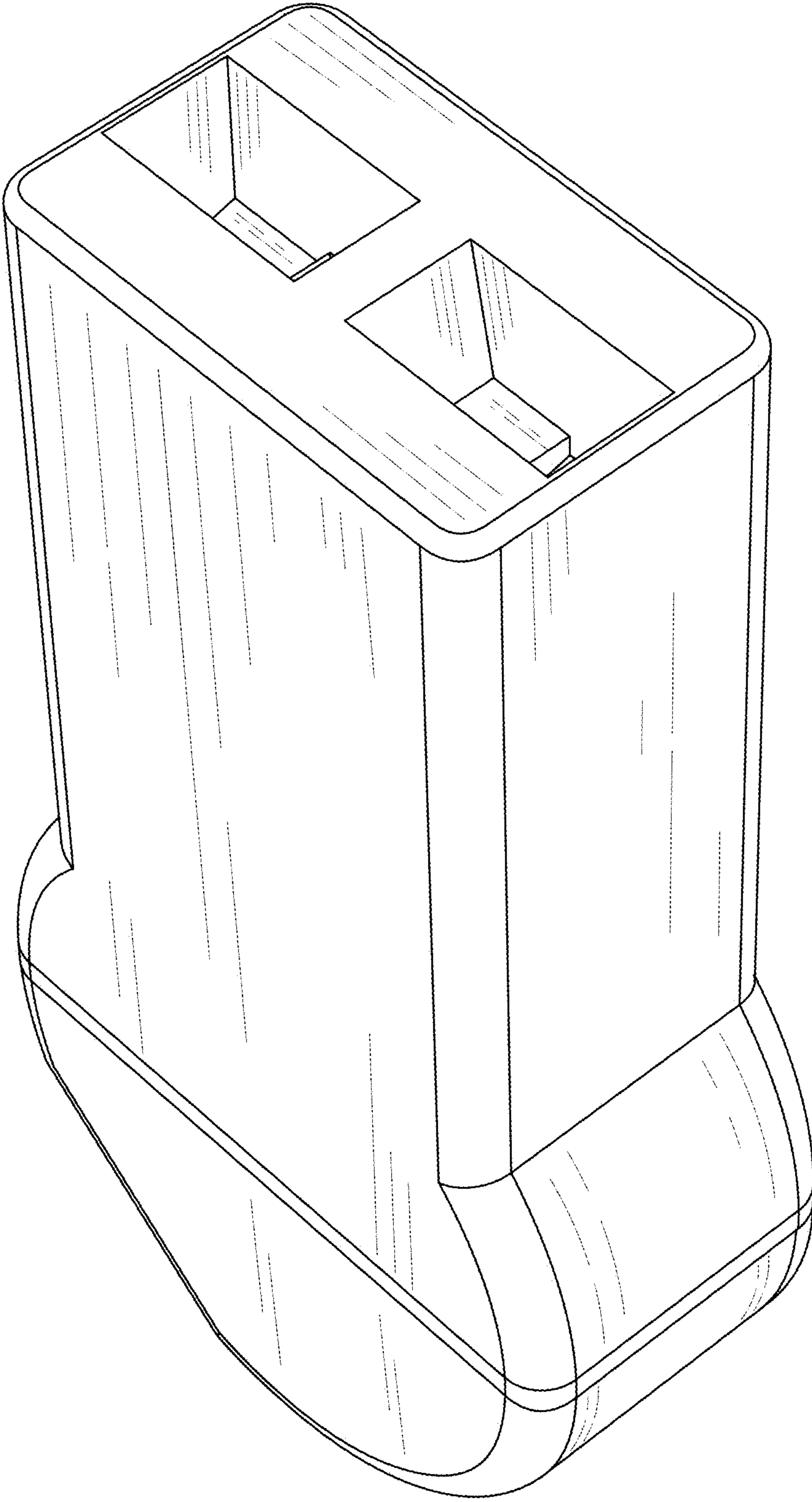

Fig. 8