



US00D922537S

(12) **United States Design Patent** (10) **Patent No.:** **US D922,537 S**  
**Bahler** (45) **Date of Patent:** **\*\* Jun. 15, 2021**

(54) **FAUCET HANDLE**  
(71) Applicant: **DELTA FAUCET COMPANY**,  
Indianapolis, IN (US)  
(72) Inventor: **Jordan Bahler**, Frankfort, IN (US)  
(73) Assignee: **DELTA FAUCET COMPANY**,  
Indianapolis, IN (US)  
(\*\*) Term: **15 Years**  
(21) Appl. No.: **29/711,621**  
(22) Filed: **Nov. 1, 2019**  
(51) **LOC (13) Cl.** ..... **23-01**  
(52) **U.S. Cl.**  
USPC ..... **D23/252**  
(58) **Field of Classification Search**  
USPC ..... D23/238-243, 250, 252, 254; D8/300,  
D8/307  
See application file for complete search history.

D734,122 S \* 7/2015 Hsu ..... D8/308  
D863,509 S \* 10/2019 Rockwell ..... D23/242  
D888,201 S \* 6/2020 Eads ..... D23/252  
2020/0024837 A1\* 1/2020 Wales ..... E03C 1/0412

\* cited by examiner

*Primary Examiner* — Robert A Delehanty  
(74) *Attorney, Agent, or Firm* — Nirav D. Parikh; Edgar  
A. Zarins

(57) **CLAIM**

The ornamental design for a faucet handle, as shown and described.

**DESCRIPTION**

FIG. 1 is a front perspective view of a faucet handle showing my new design;  
FIG. 2 is a rear perspective view thereof;  
FIG. 3 is a front elevational view thereof;  
FIG. 4 is a left side view thereof;  
FIG. 5 is a rear view thereof;  
FIG. 6 is a right side view thereof; and,  
FIG. 7 is a top plan view thereof.

**1 Claim, 4 Drawing Sheets**

(56) **References Cited**  
U.S. PATENT DOCUMENTS  
D311,320 S \* 10/1990 Jans ..... D8/308  
D630,490 S \* 1/2011 Lundstrom ..... D8/300

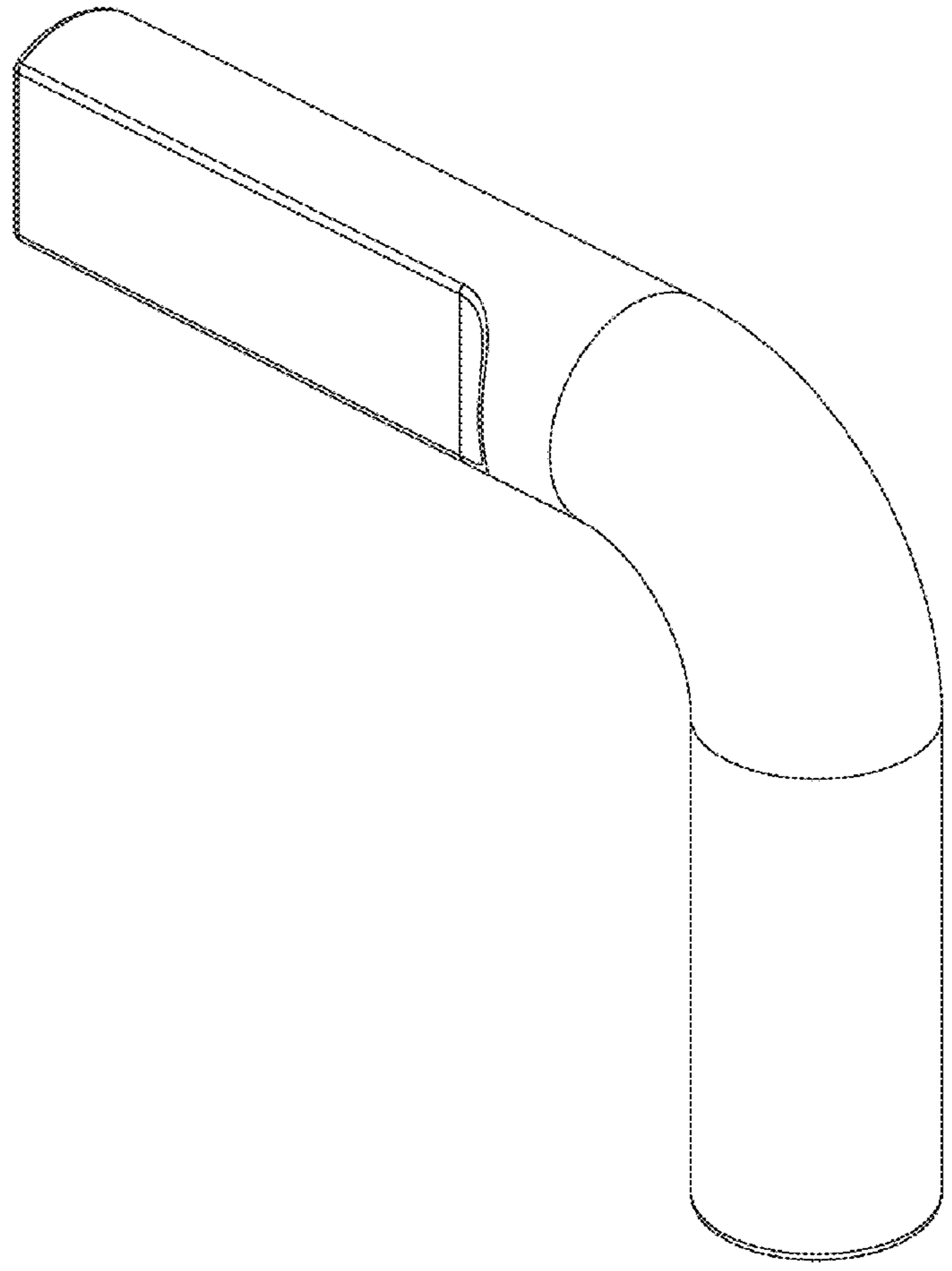

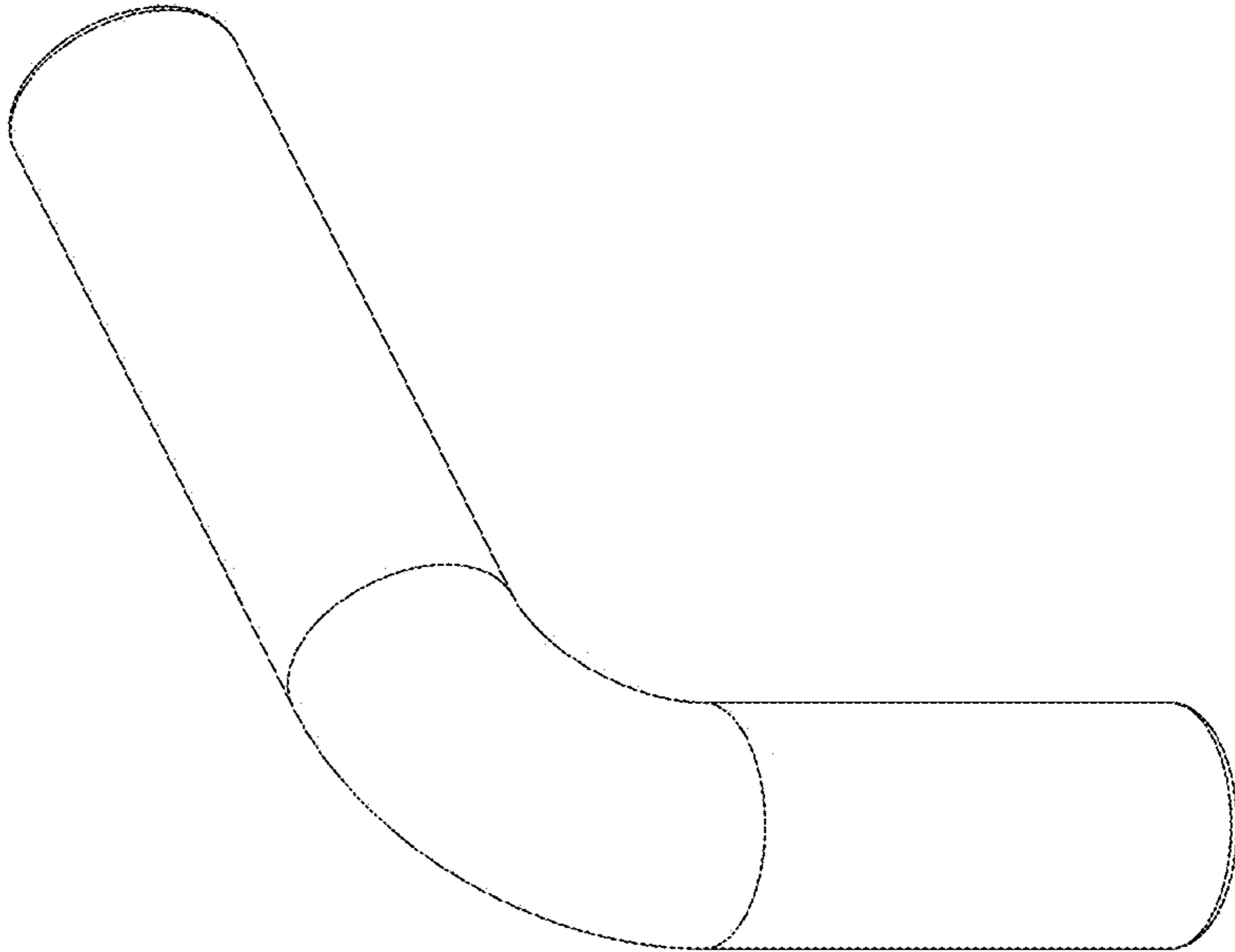

Fig. 2

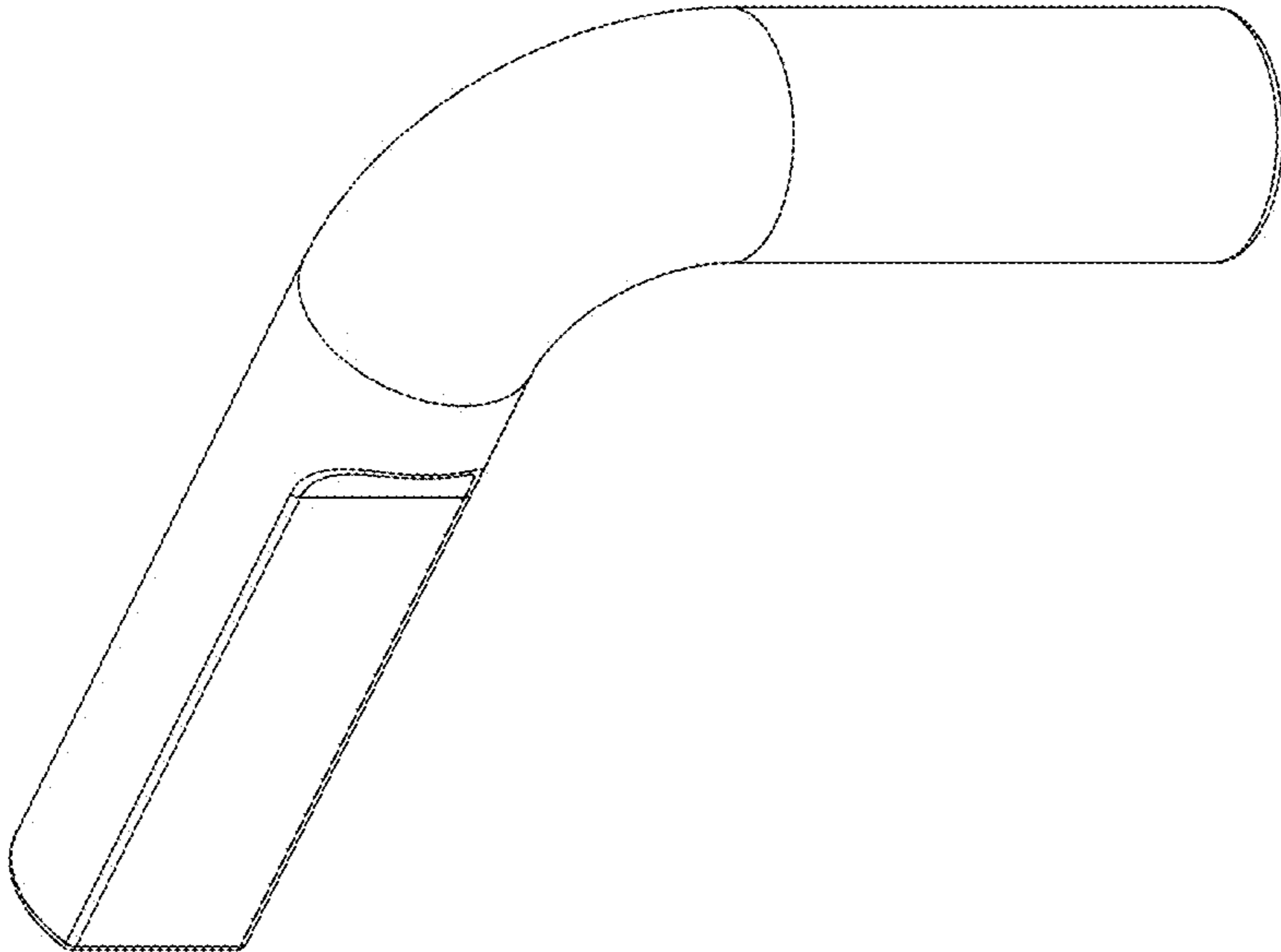

Fig. 1

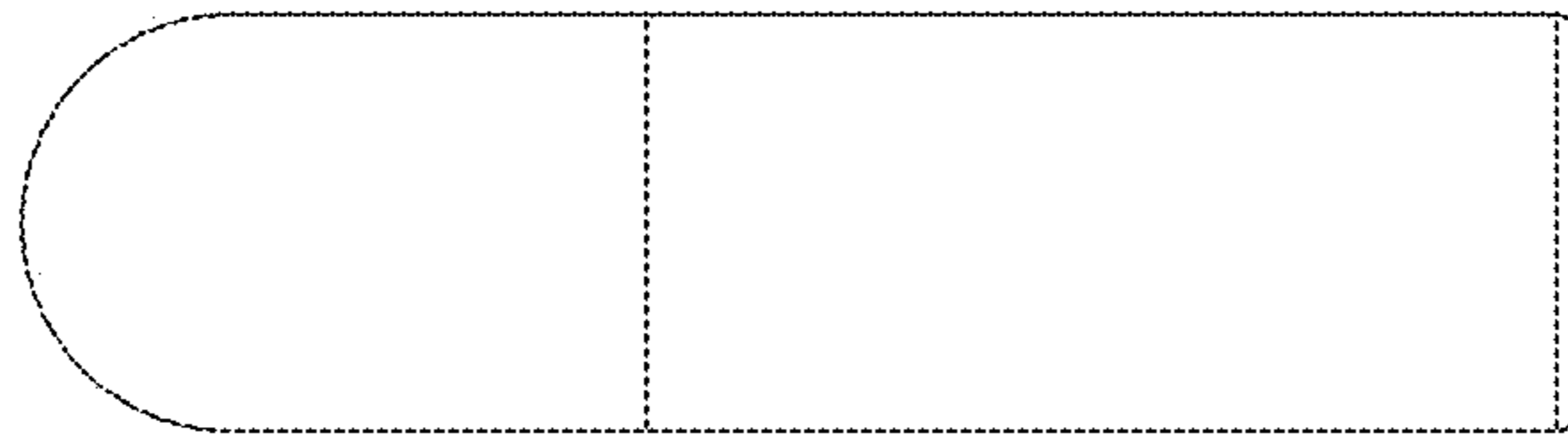

Fig. 4

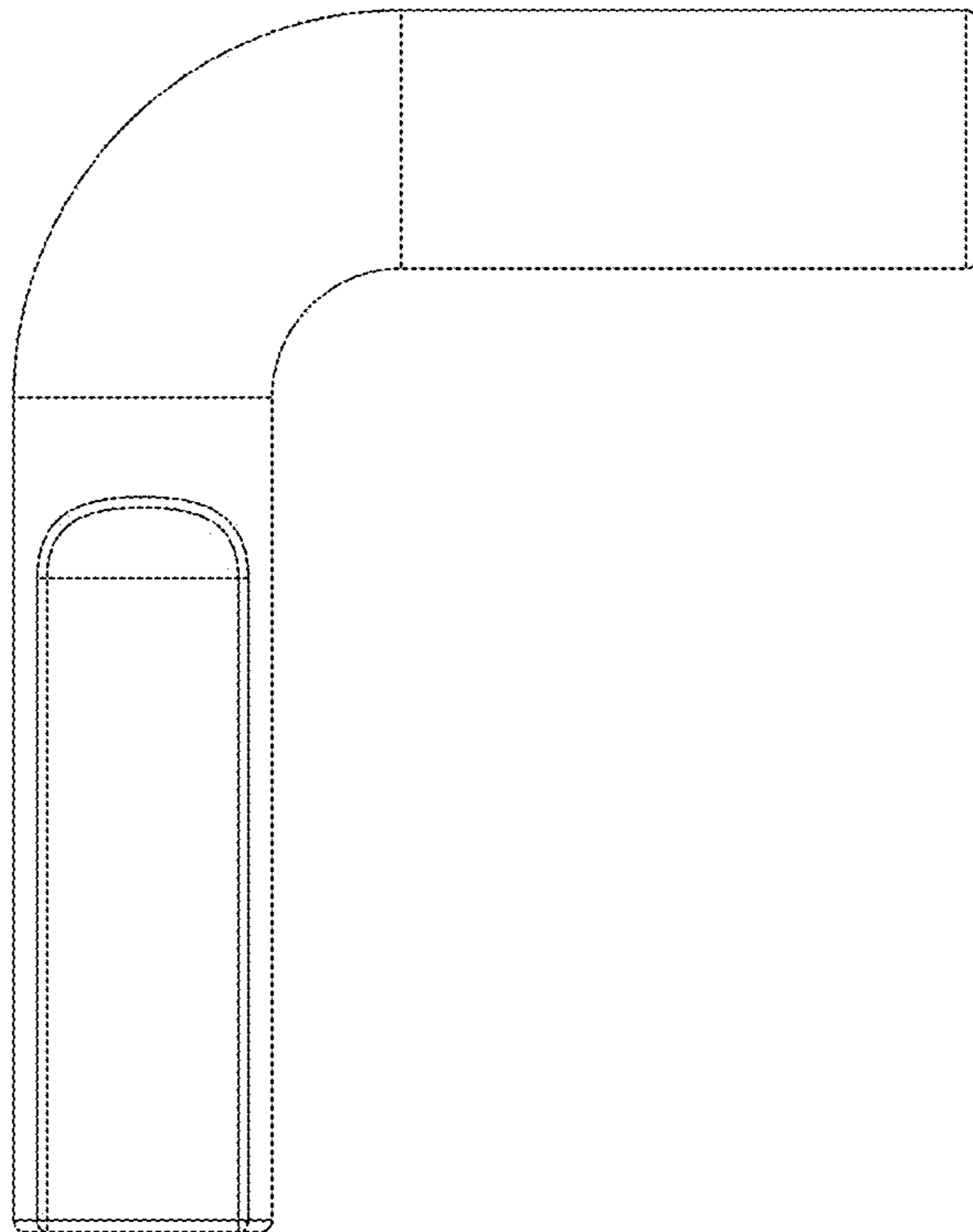

Fig. 3

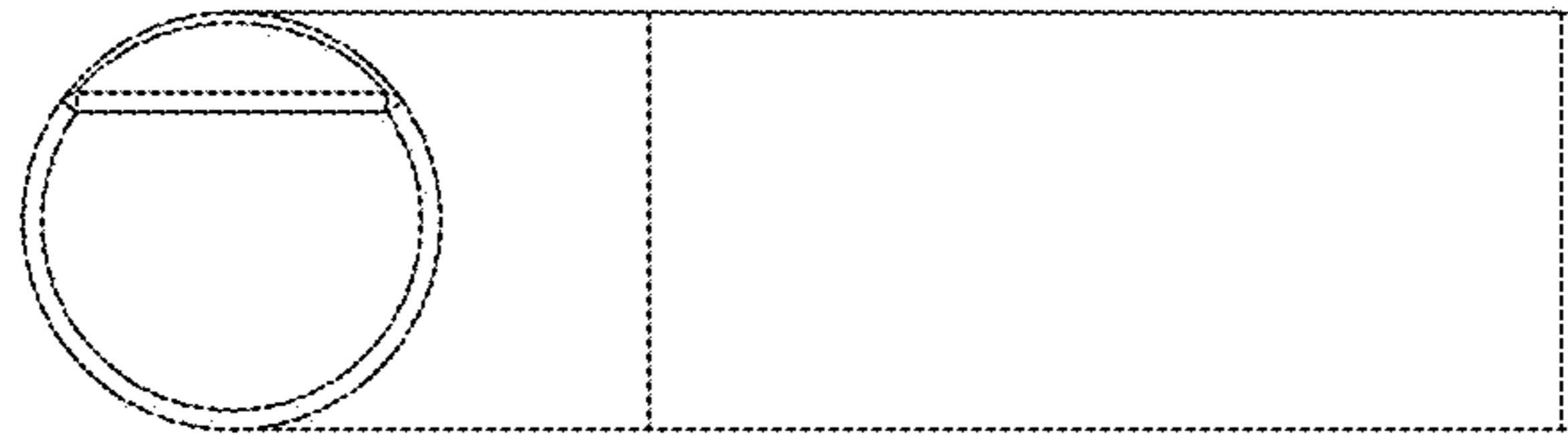

Fig. 6

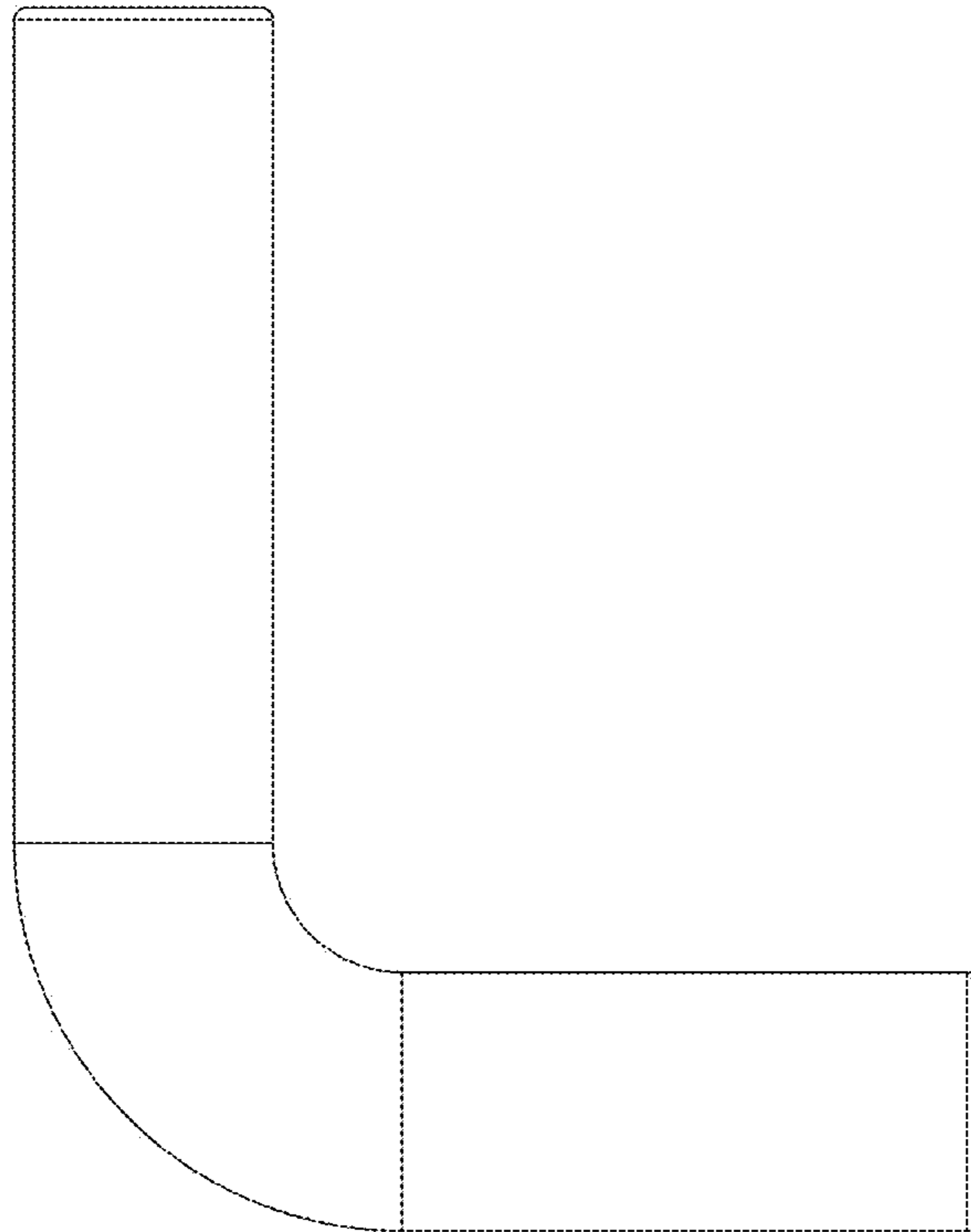

Fig. 5

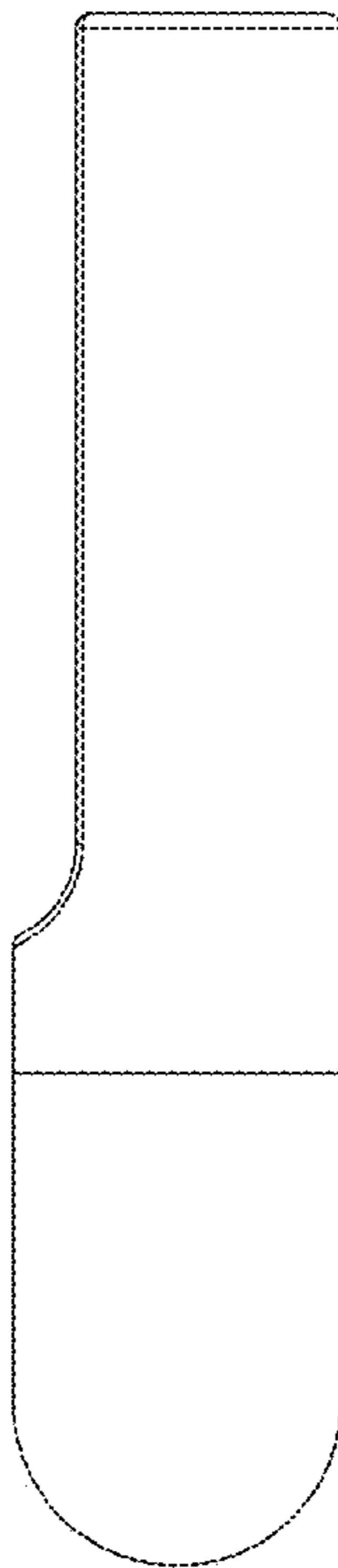

Fig. 7