



US00D922527S

(12) **United States Design Patent** (10) **Patent No.:** **US D922,527 S**
Stoler (45) **Date of Patent:** **** Jun. 15, 2021**

(54) **FAUCET ESCUTCHEON** D527,800 S * 9/2006 Schaffeld D23/249
D602,571 S * 10/2009 Kwok D23/249
(71) Applicant: **DELTA FAUCET COMPANY,** D683,429 S * 5/2013 Kwok D23/238
Indianapolis, IN (US) D810,881 S * 2/2018 Bahler D23/249

(72) Inventor: **Benjamin David Stoler,** Carmel, IN (US)

FOREIGN PATENT DOCUMENTS

CA 174175 * 4/2017
CN 305680394 * 9/2019

(73) Assignee: **DELTA FAUCET COMPANY,** Indianapolis, IN (US)

OTHER PUBLICATIONS

(**) Term: **15 Years**

Gongong Deck Plate, announced Nov. 30, 2019[online], [site visited Aug. 28, 2020]. Available from internet, URL:<https://www.amazon.com/Gangang-Kitchen-Faucet-Bathroom-Escutcheon/dp/B0816F2MXC> (Year: 2019).*

(21) Appl. No.: **29/683,119**

Deck plate, announced Oct. 28, 2019[online], [site visited Aug. 28, 2020]. Available from internet, URL:<https://www.amazon.com/FarBoat-Hardware-Escutcheon-Stainless-Chrome-Plated/dp/B07ZPM879C> (Year: 2019).*

(22) Filed: **Mar. 11, 2019**

(51) **LOC (13) Cl.** **23-01**

(52) **U.S. Cl.**
USPC **D23/238**

(58) **Field of Classification Search**
USPC D23/238-245, 249, 252, 254;
D8/307-308
CPC Y10T 137/9464
See application file for complete search history.

* cited by examiner

Primary Examiner — Barbara Fox
Assistant Examiner — Jamaal Rasheed
(74) *Attorney, Agent, or Firm* — Nirav D. Parikh; Edgar A. Zarins

(56) **References Cited**

U.S. PATENT DOCUMENTS

D260,677 S * 9/1981 Thevenot D23/238
D360,679 S * 7/1995 Doughty D23/241
D374,709 S * 10/1996 Doughty D23/241
D399,923 S * 10/1998 Ko D23/238
D404,119 S * 1/1999 Lord D23/239
D404,466 S * 1/1999 Lord D23/239
D413,652 S * 9/1999 Ko D23/242
D428,969 S * 8/2000 Pitsch D23/241
D437,031 S * 1/2001 Nguyen D23/238
D438,291 S * 2/2001 Lord D23/241
D440,284 S * 4/2001 Pitsch D23/241
D441,841 S * 5/2001 Hunter D23/241
D469,855 S * 2/2003 Hunter D23/241
D491,635 S * 6/2004 Lin D23/249
D509,566 S * 9/2005 Yegyayan D23/249
D524,419 S * 7/2006 Lord D23/249
D526,048 S * 8/2006 Schaffeld D23/249

(57) **CLAIM**

The ornamental design for a faucet escutcheon, as shown and described.

DESCRIPTION

FIG. 1 is a front perspective view of a faucet escutcheon showing my new design;
FIG. 2 is a rear perspective view thereof;
FIG. 3 is a front elevational view thereof;
FIG. 4 is a left side view thereof;
FIG. 5 is a rear view thereof;
FIG. 6 is a right side view thereof; and,
FIG. 7 is a top plan view thereof.

1 Claim, 4 Drawing Sheets

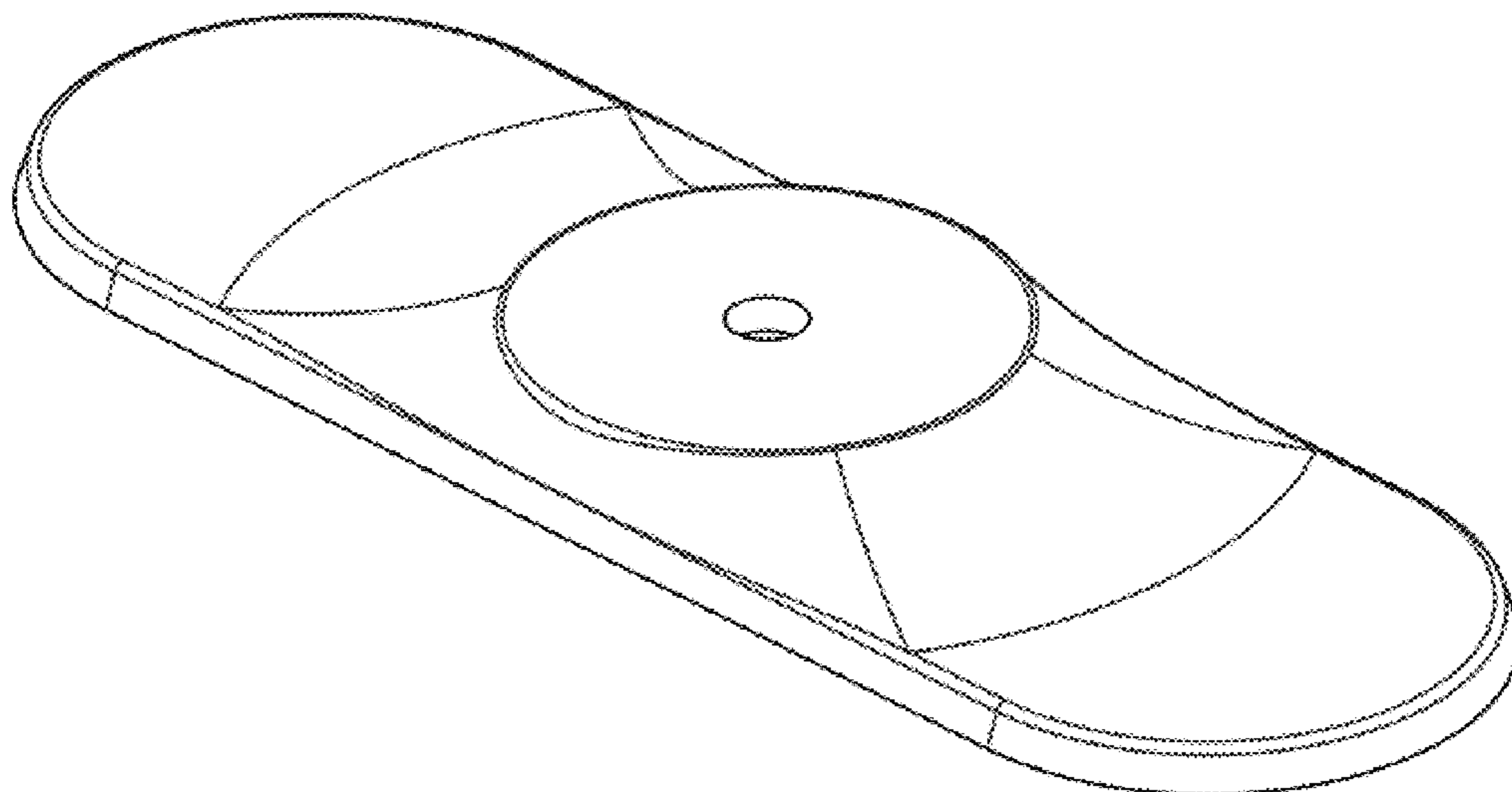

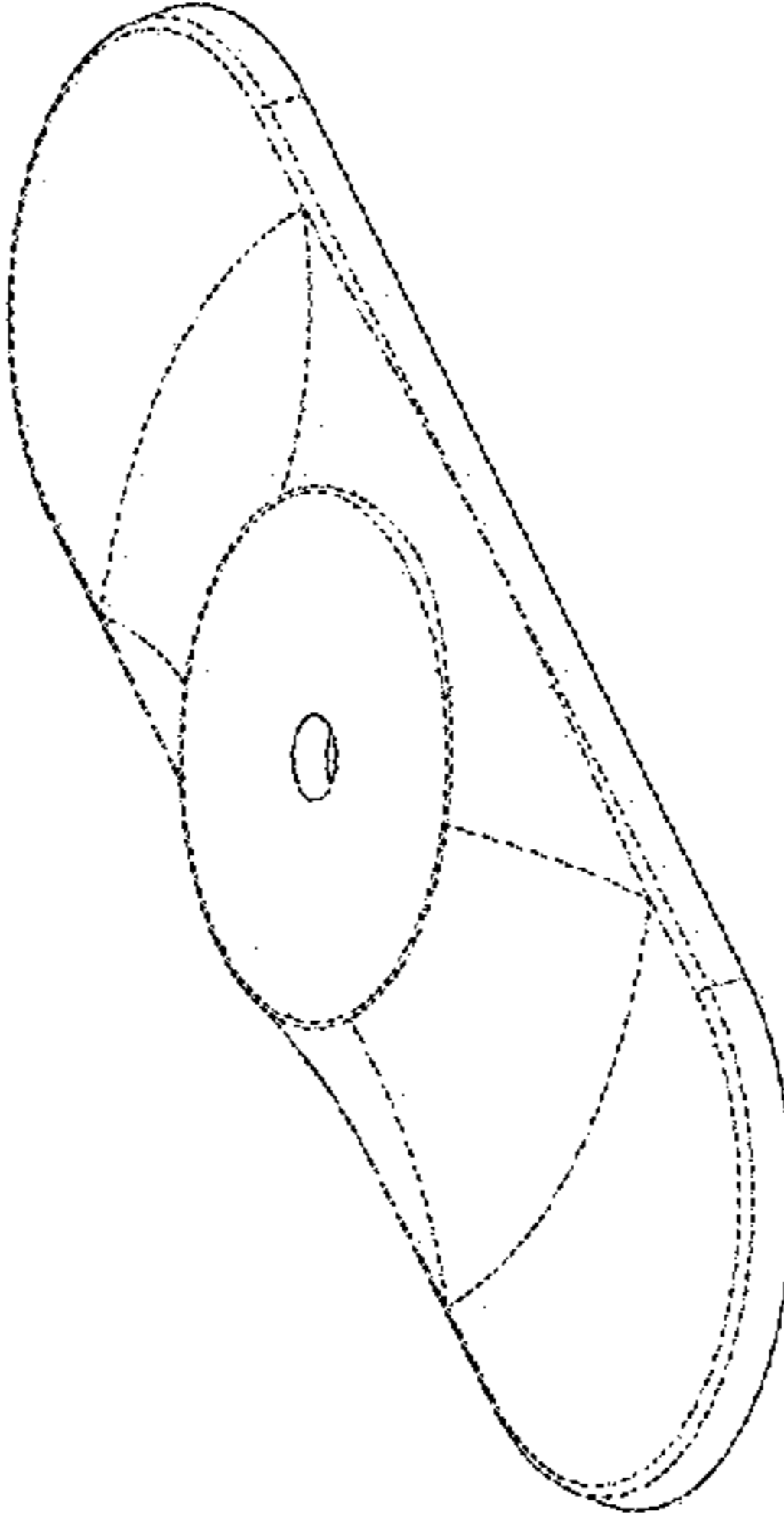

FIG - 2

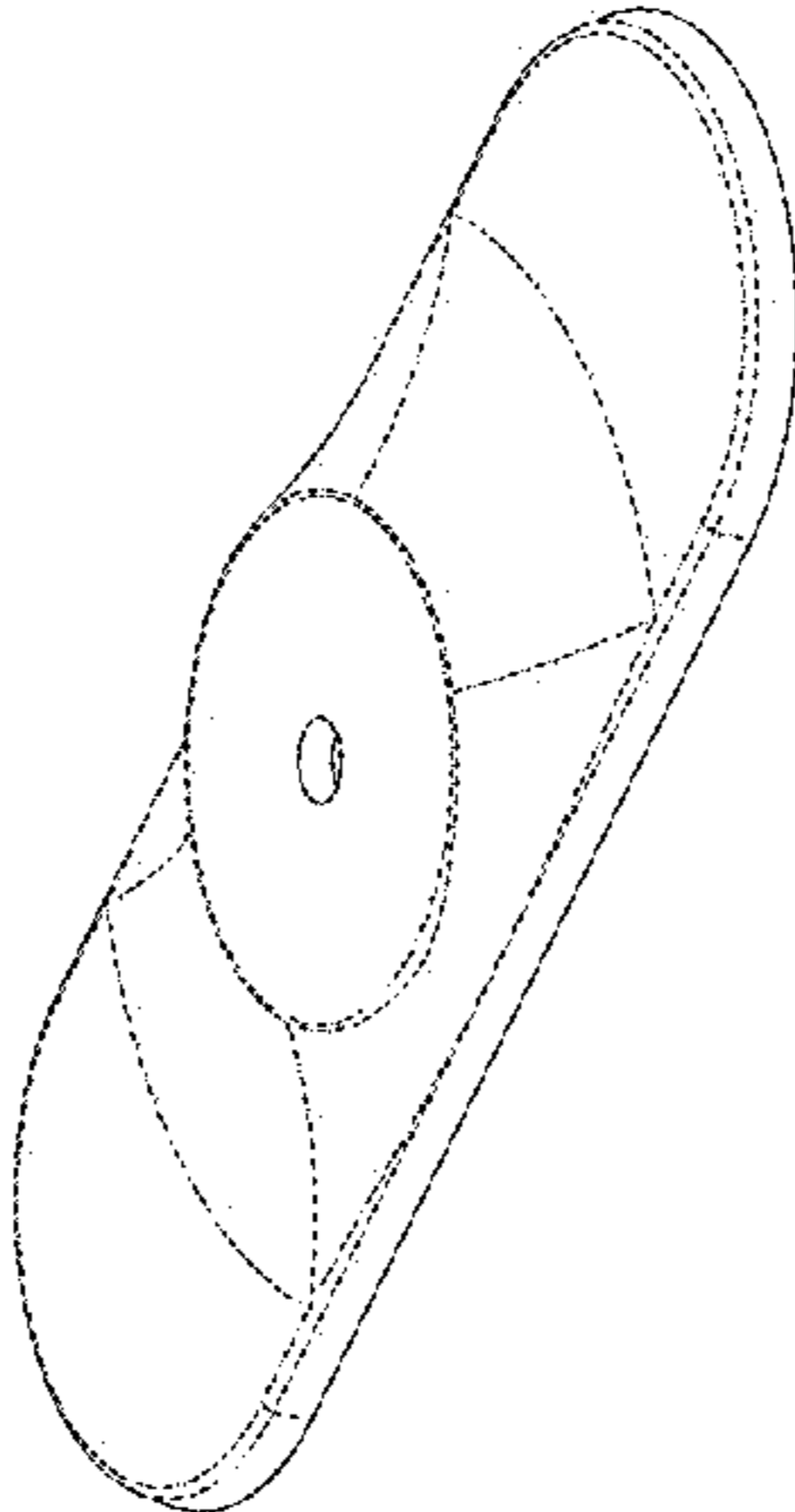

FIG - 1

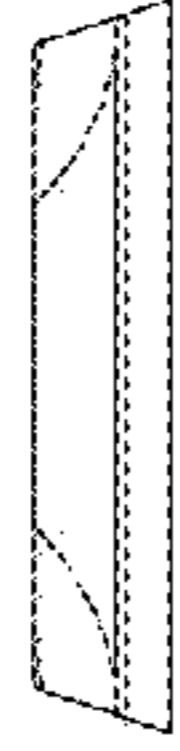

FIG - 4

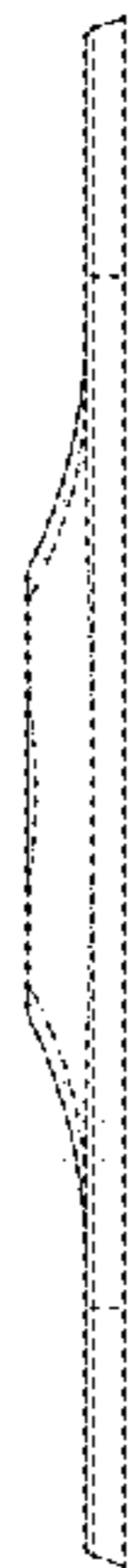

FIG - 3

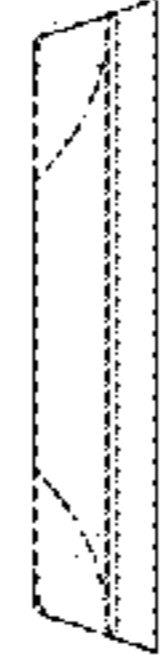

FIG - 6

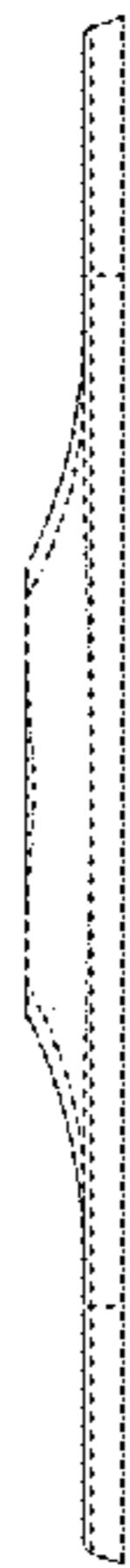

FIG - 5

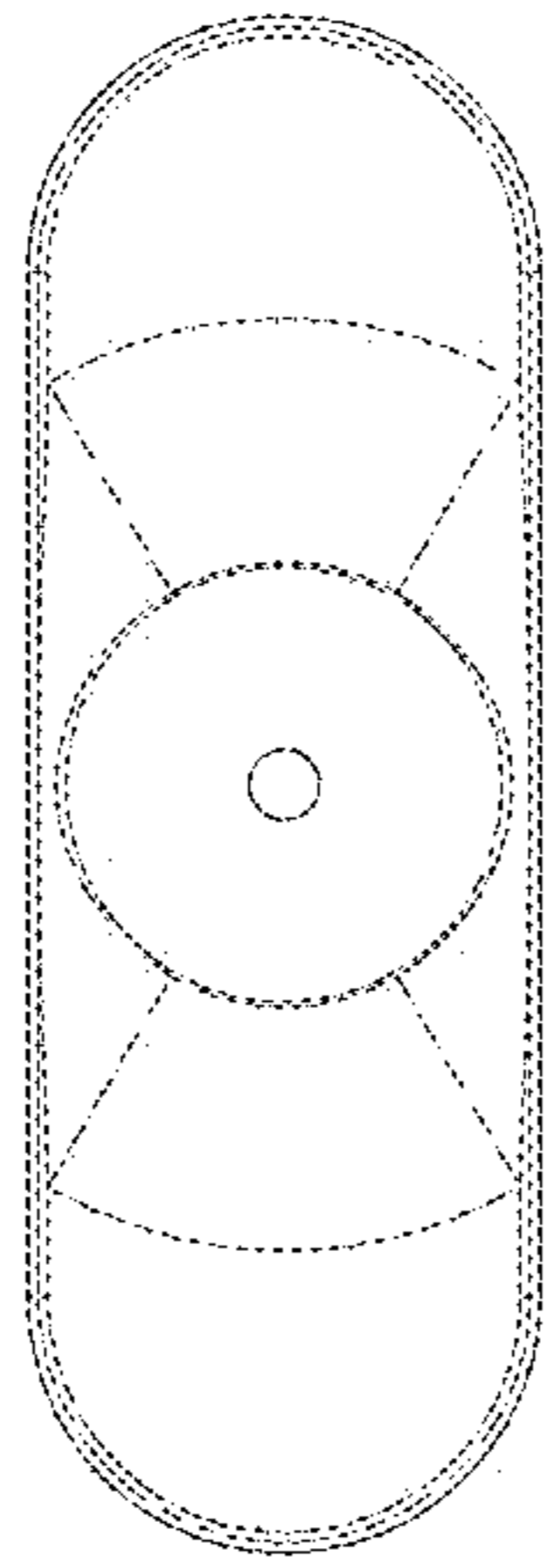

FIG - 7