



US00D922526S

(12) **United States Design Patent** (10) **Patent No.:** **US D922,526 S**
Johnson (45) **Date of Patent:** **** Jun. 15, 2021**

(54) **FAUCET**
(71) Applicant: **KOHLER CO.**, Kohler, WI (US)
(72) Inventor: **Drew Johnson**, Sheboygan, WI (US)
(73) Assignee: **KOHLER CO.**, Kohler, WI (US)
(**) Term: **15 Years**

D797,902 S 9/2017 Georgeson
D815,249 S 4/2018 Kuang
D820,399 S 6/2018 Garland
D839,394 S 1/2019 Mai
D848,578 S 5/2019 Garland
D855,158 S 7/2019 Eads
D857,166 S 8/2019 Spangler
D867,526 S 11/2019 Garland
D867,527 S 11/2019 Eads
D867,532 S 11/2019 Liao

(21) Appl. No.: **29/745,329**
(22) Filed: **Aug. 5, 2020**

OTHER PUBLICATIONS

No additional references cited (Year: 2021).*

Related U.S. Application Data

(62) Division of application No. 29/677,291, filed on Jan. 18, 2019, now Pat. No. Des. 895,068.
(51) **LOC (13) Cl.** **23-01**
(52) **U.S. Cl.**
USPC **D23/226**
(58) **Field of Classification Search**
USPC D23/238, 241-243, 249, 255, 257, 213, D23/226
CPC Y10T 137/9464; Y10T 137/6014; Y10T 137/6017
See application file for complete search history.

* cited by examiner

Primary Examiner — Robert A Delehanty
(74) *Attorney, Agent, or Firm* — Foley & Lardner LLP

(57) **CLAIM**

I claim the ornamental design for a faucet, as shown and described.

DESCRIPTION

FIG. 1 is a perspective view of another embodiment of the claimed design;
FIG. 2 is a front view of the embodiment of FIG. 1;
FIG. 3 is a rear view of the embodiment of FIG. 1;
FIG. 4 is a side view of the embodiment of FIG. 1;
FIG. 5 is another side view of the embodiment of FIG. 1;
FIG. 6 is a top view of the embodiment of FIG. 1; and,
FIG. 7 is a bottom view of the embodiment of FIG. 1.
The ornamental design which is claimed is shown in solid lines in the drawings. The broken lines in the drawings are for illustrative purposes only and form no part of the claimed design. Broken lines formed of unequal length dashes (i.e., dash-dot) define bounds of the claimed design.

(56) **References Cited**
U.S. PATENT DOCUMENTS

D342,308 S 12/1993 McKeone
D376,413 S 12/1996 Kergoet
D573,696 S 7/2008 Eilmus
D577,421 S 9/2008 Williams
D585,112 S 1/2009 Kohler et al.
D683,825 S 6/2013 Sofield
D689,595 S 9/2013 Georgeson
D713,939 S 9/2014 Mazz et al.
D721,422 S 1/2015 Sedwick
D721,791 S 1/2015 Bahler
D762,285 S 7/2016 Jepson et al.

1 Claim, 7 Drawing Sheets

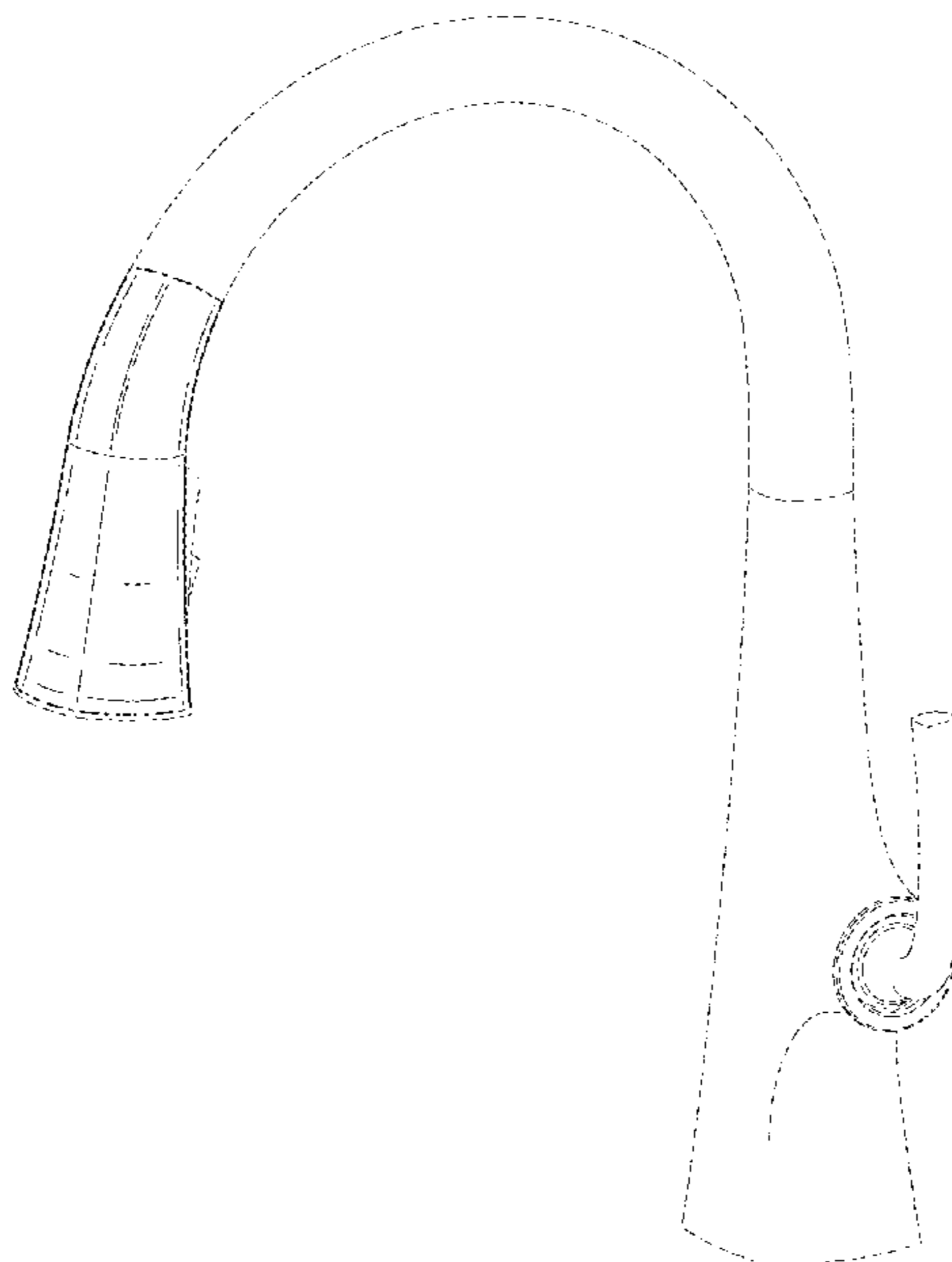

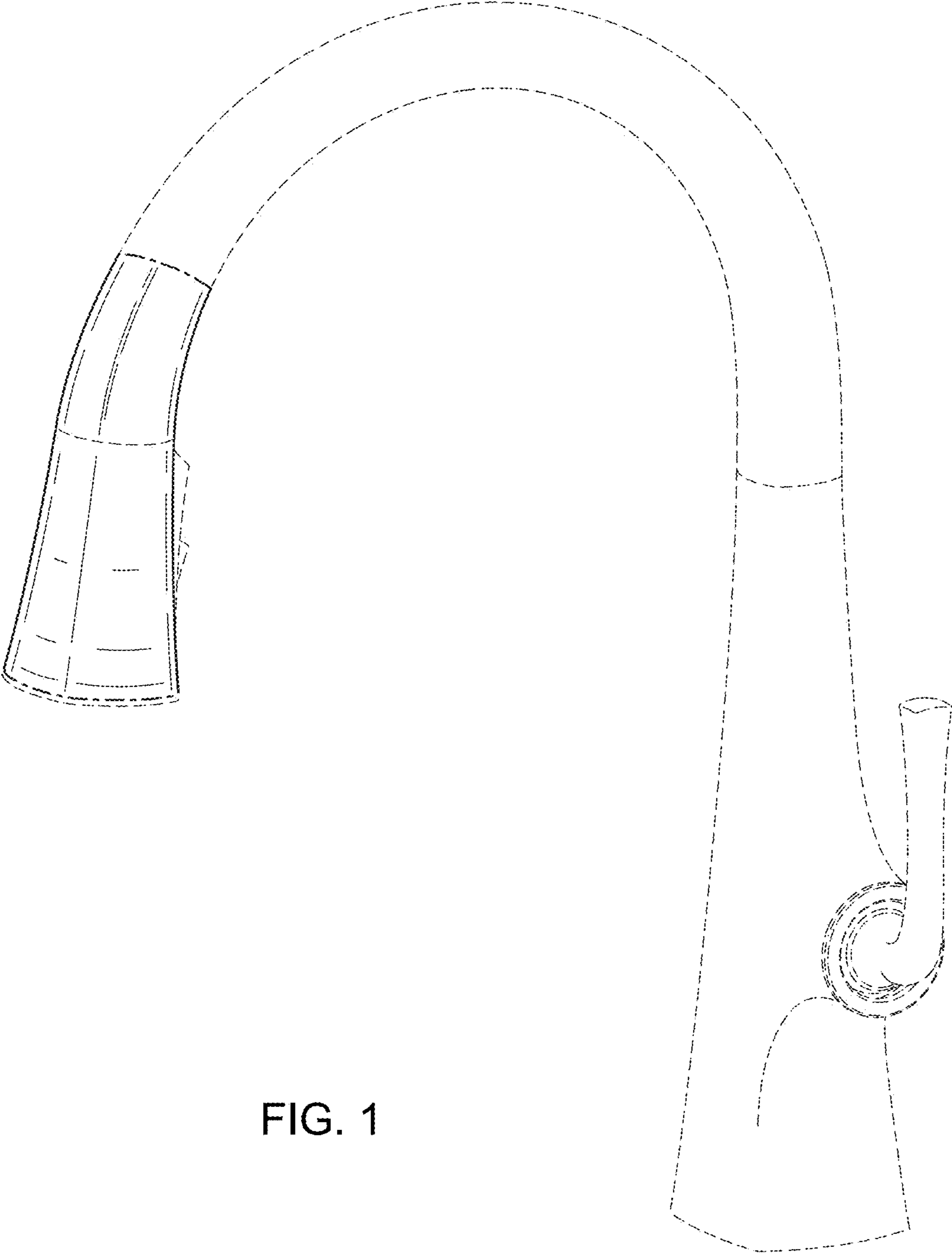

FIG. 1

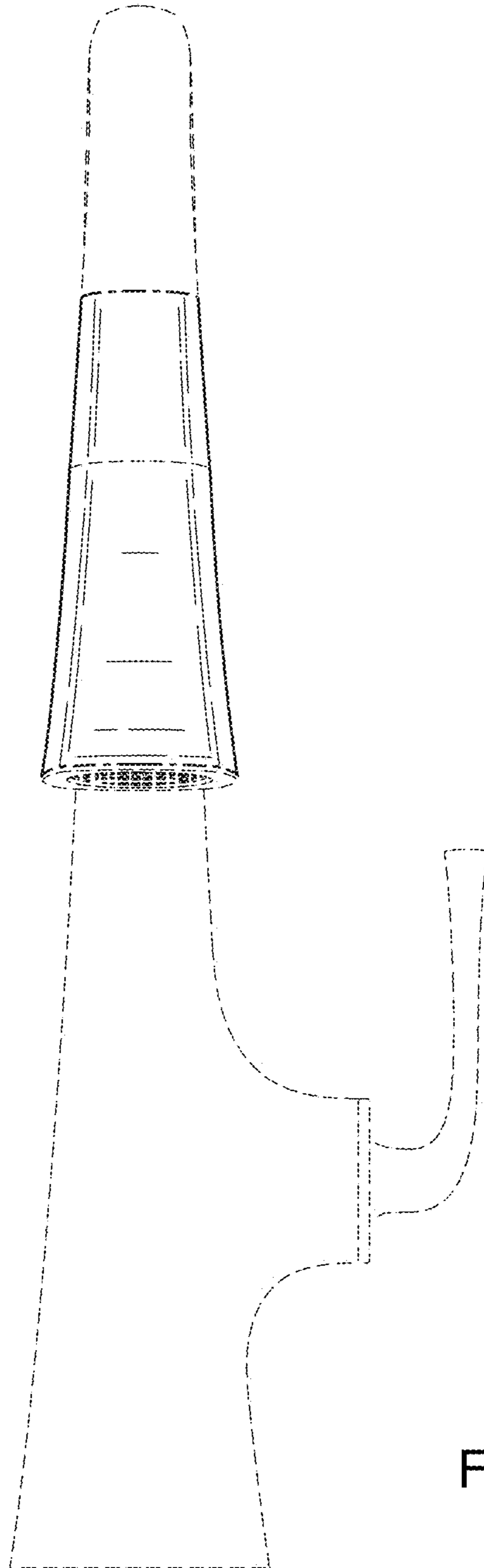

FIG. 2

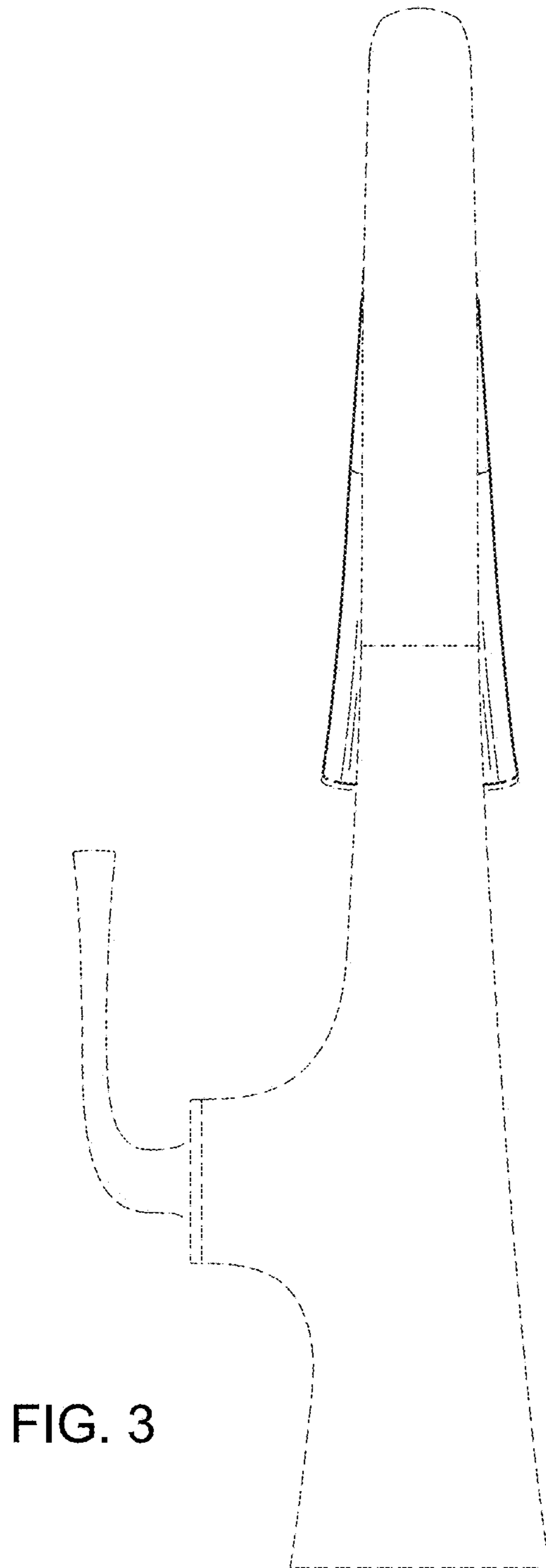

FIG. 3

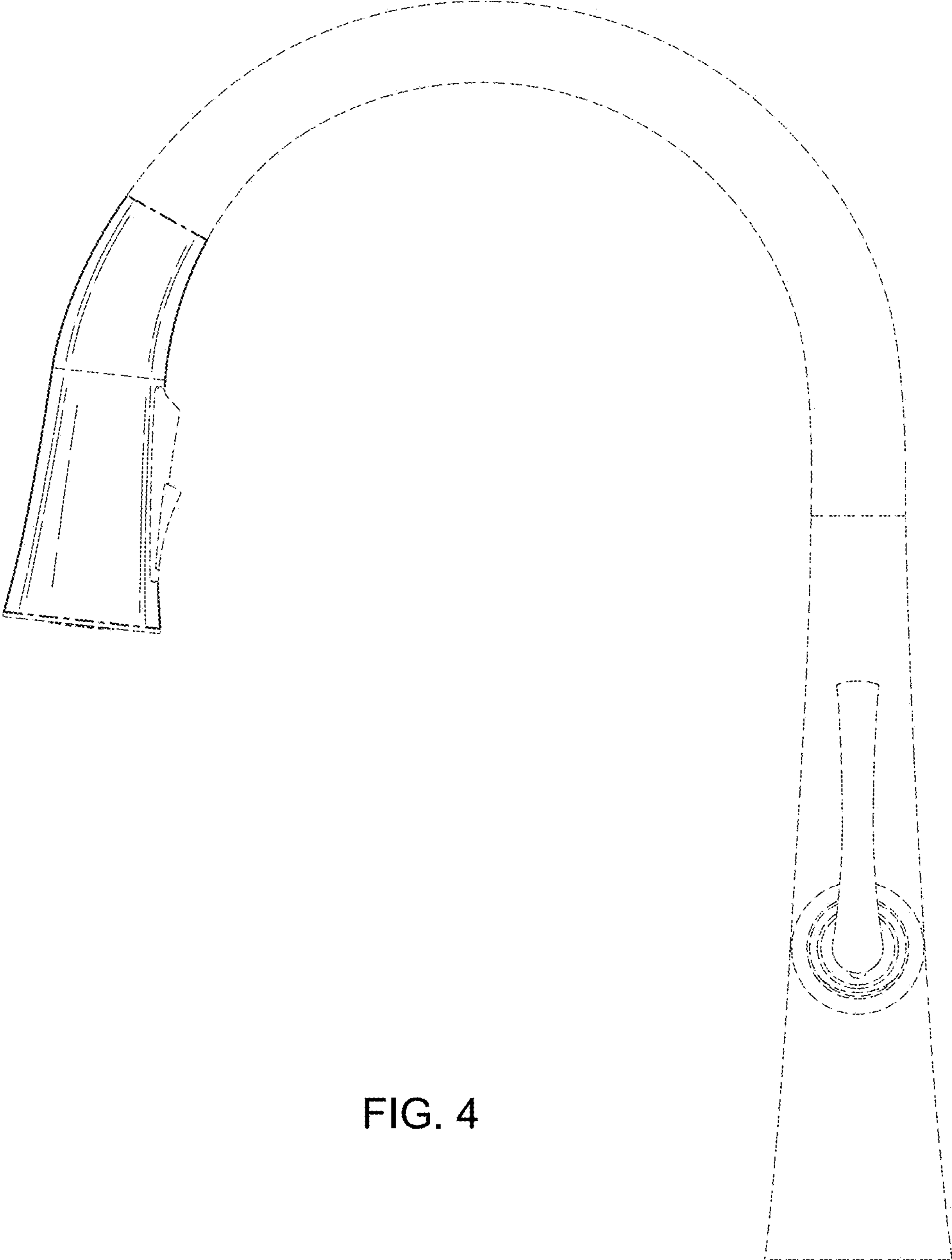

FIG. 4

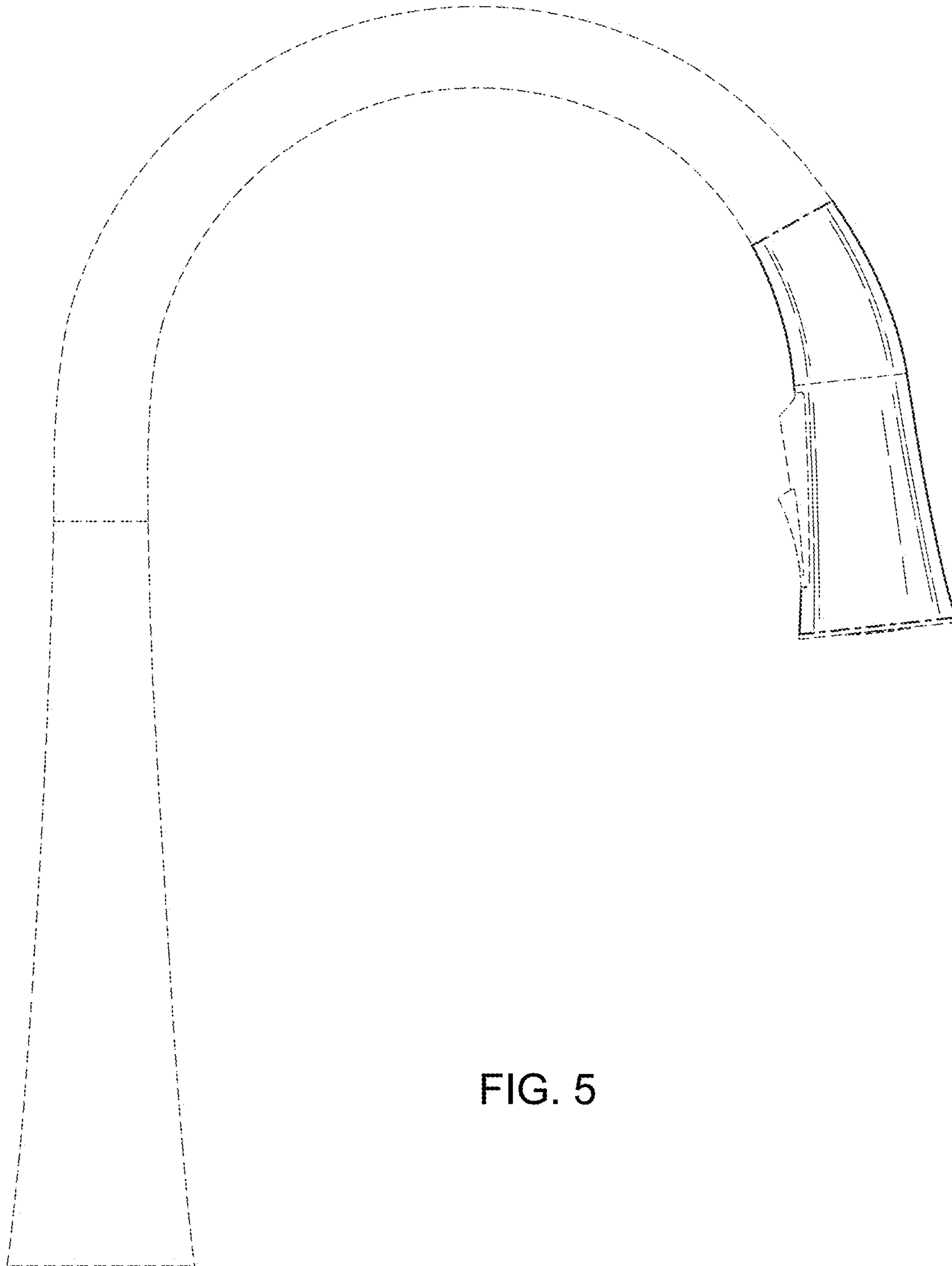

FIG. 5

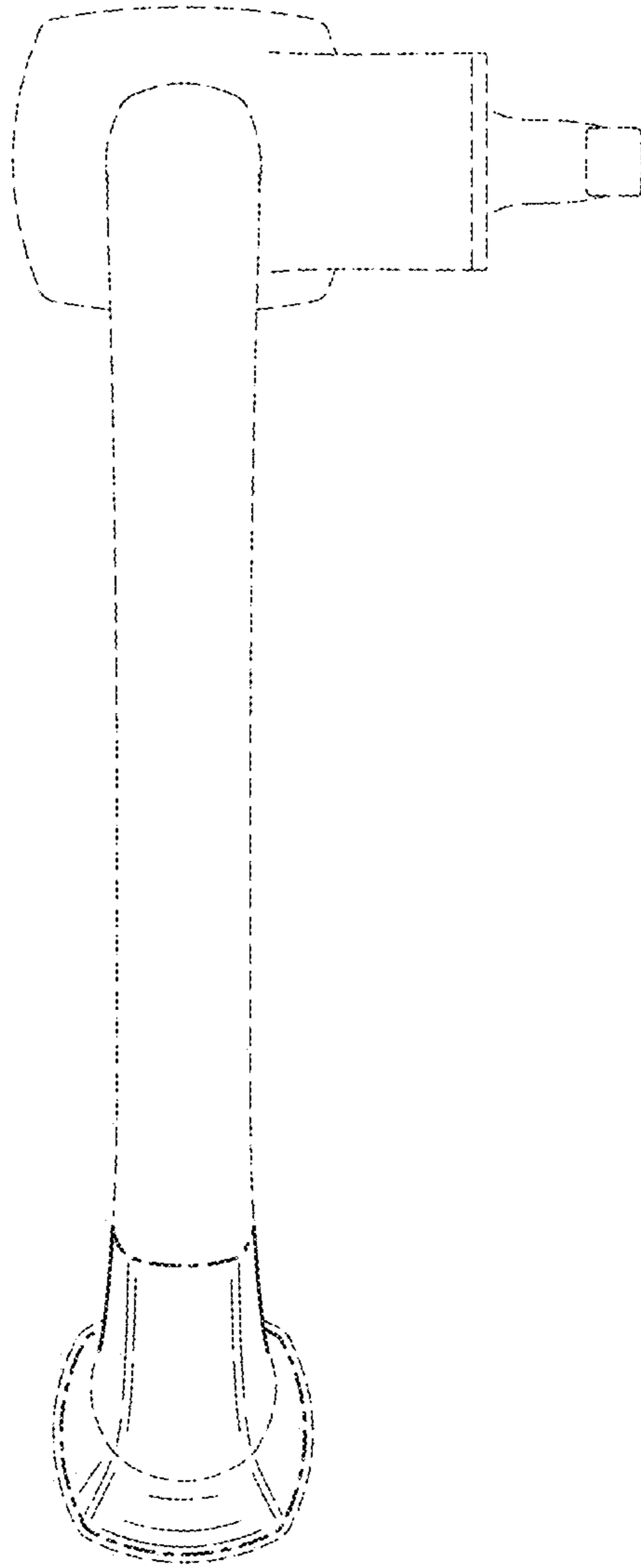

FIG. 6

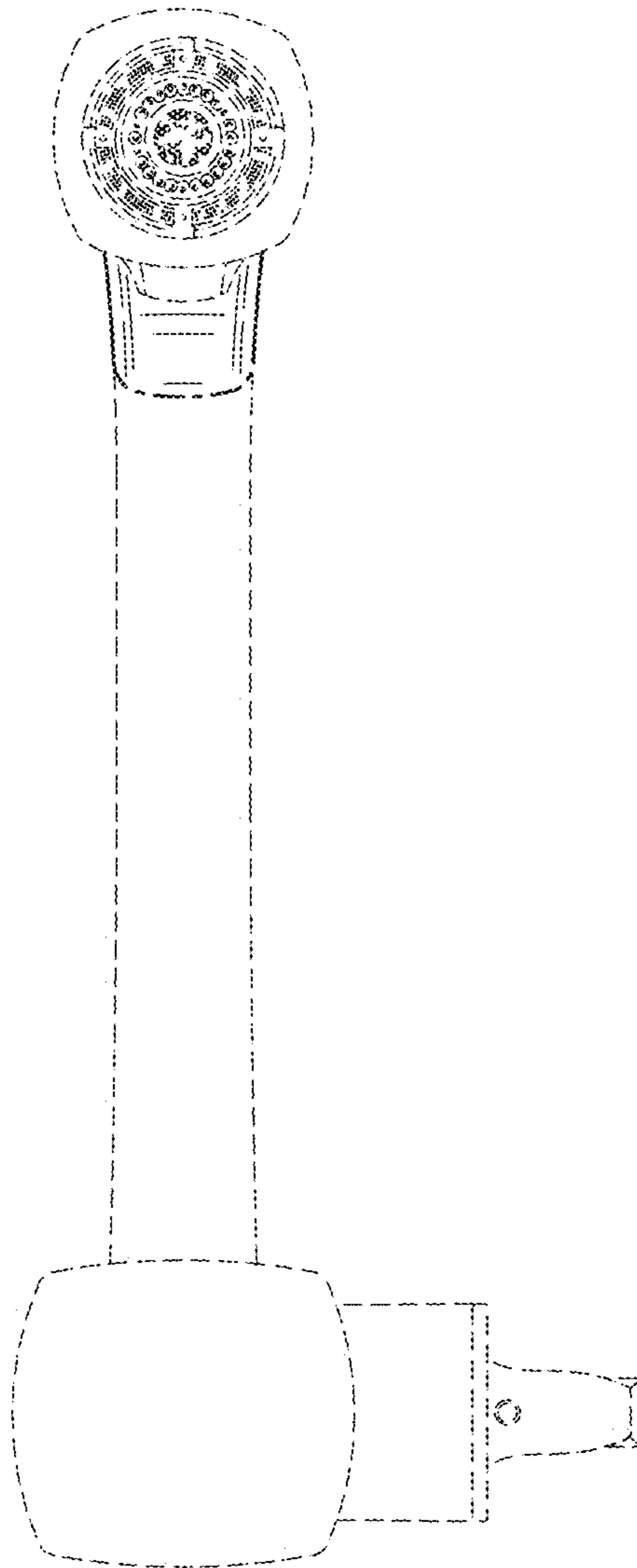

FIG. 7