



US00D922465S

(12) **United States Design Patent** (10) **Patent No.:** **US D922,465 S**
Lee et al. (45) **Date of Patent:** **** Jun. 15, 2021**

(54) **HOUSEHOLD ROBOT**

FOREIGN PATENT DOCUMENTS

(71) Applicant: **LG ELECTRONICS INC.**, Seoul (KR)

JP 2007260822 A * 10/2007

Primary Examiner — Richard E Chilcot

(72) Inventors: **Younghwan Lee**, Seoul (KR); **Hophil Lee**, Seoul (KR); **Jaebom Im**, Seoul (KR)

(74) *Attorney, Agent, or Firm* — Birch, Stewart, Kolasch & Birch, LLP

(73) Assignee: **LG Electronics Inc.**, Seoul (KR)

(57) **CLAIM**

The ornamental design for a household robot, as shown and described.

(**) Term: **15 Years**

DESCRIPTION

(21) Appl. No.: **35/509,238**

1. Household robot

(22) Filed: **Jun. 20, 2019**

1.1 : Perspective

(80) **Hague Agreement Data**

Int. Filing Date: **Jun. 20, 2019**

1.2 : Front

Int. Reg. No.: **DM/207390**

1.3 : Back

Int. Reg. Date: **Jun. 20, 2019**

1.4 : Left

Int. Reg. Pub. Date: **May 1, 2020**

1.5 : Right

1.6 : Top

1.7 : Bottom

1.8 : Perspective

1.9 : Front

1.10 : Back

(30) **Foreign Application Priority Data**

Jan. 30, 2019 (KR) 30-2019-0004694

1.11 : Left

1.12 : Right

1.13 : Top

1.14 : Bottom

(51) **LOC (13) Cl.** **15-99**

1.15 : Perspective

(52) **U.S. Cl.**

1.16 : Front

USPC **D15/199**

1.17 : Back

(58) **Field of Classification Search**

USPC D15/199; D21/419-435, 533, 537, 760, D21/765, 771; 280/87.021, 87.041, 200,

1.18 : Left

1.19 : Right

1.20 : Top

1.21 : Bottom

(Continued)

1.22 : Perspective

1.23 : Front

1.24 : Left

1.25 : Back

1.26 : Right

1.27 : Top

1.28 : Bottom

1.29 : Perspective

(56) **References Cited**

U.S. PATENT DOCUMENTS

4,717,364 A * 1/1988 Furukawa A63H 11/00 367/198

D298,766 S * 11/1988 Tanno D21/578

(Continued)

(Continued)

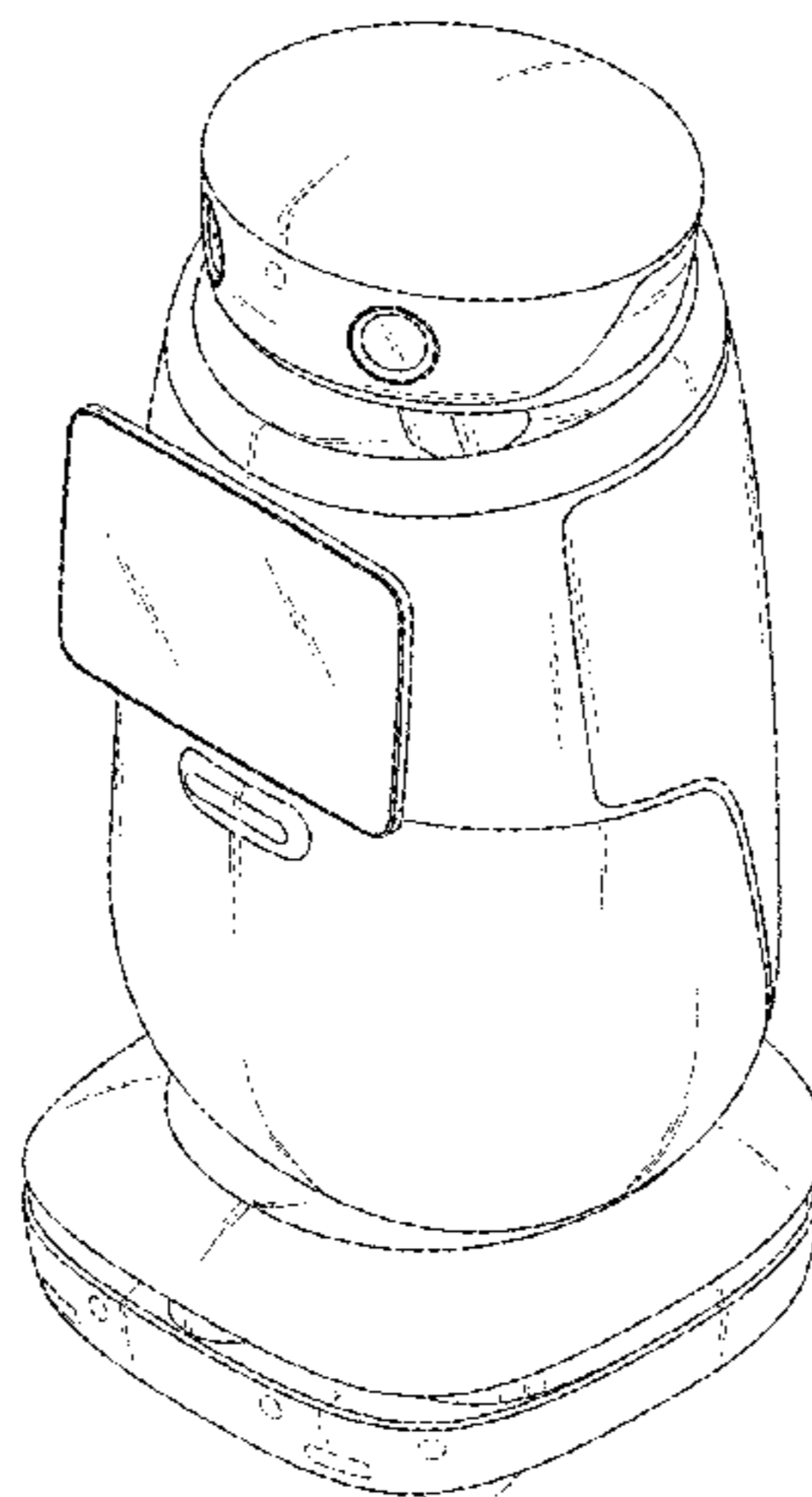

- 1.30 : Front
- 1.31 : Back
- 1.32 : Left
- 1.33 : Right
- 1.34 : Top
- 1.35 : Bottom

The parts shown by means of broken lines in the reproductions are not part of the claimed design.

1 Claim, 35 Drawing Sheets

- (52) **U.S. Cl.**
CPC *B25J 11/00* (2013.01)
- (58) **Field of Classification Search**
USPC 280/210, 214, 239, 263, 282,
280/288.1–288.4; 180/180, 181, 21, 8.2,
180/5.26, 6.5, 7.1, 65.8, 907
CPC B25J 11/00; B25J 11/008
See application file for complete search history.

(56) **References Cited**

U.S. PATENT DOCUMENTS

D456,080 S * 4/2002 Karlsson D24/185
D549,756 S * 8/2007 Park D15/199
D563,443 S * 3/2008 Ahn D15/199
D566,737 S * 4/2008 Matsuda D15/199
D572,739 S * 7/2008 Jennings D15/199
D579,035 S * 10/2008 Kim B25J 11/008
D608,804 S * 1/2010 Labak D15/199
D631,074 S * 1/2011 Peters D15/144
D635,603 S * 4/2011 Paz Rodriguez D15/199
D644,256 S * 8/2011 Kitano D15/199
D663,333 S * 7/2012 Kitano D15/199
D675,656 S * 2/2013 Sutherland D15/199

8,494,675 B2 * 7/2013 Ichinose G05D 1/0272
700/245
8,620,547 B2 * 12/2013 Monsere B60T 7/042
701/70
D701,256 S * 3/2014 Song D15/199
D720,378 S * 12/2014 Dye D15/199
8,935,006 B2 * 1/2015 Vu B25J 11/008
700/264
D725,166 S * 3/2015 Paik D15/199
D732,096 S * 6/2015 Jang D15/199
D735,258 S * 7/2015 Jang D15/199
D739,450 S * 9/2015 Jain D15/199
D752,668 S * 3/2016 Pedersen D15/199
9,291,698 B2 * 3/2016 Watanabe G01S 11/06
D761,339 S * 7/2016 White, Jr. D15/199
D761,894 S * 7/2016 Ho D15/199
D769,953 S * 10/2016 Bauman D15/199
9,469,031 B2 * 10/2016 Saito B25J 9/1676
D781,945 S * 3/2017 Uno D15/199
D802,040 S * 11/2017 Canoso D15/199
D810,167 S * 2/2018 Yang D15/199
D810,800 S * 2/2018 Wang D15/199
D811,458 S * 2/2018 Wang D15/199
D813,284 S * 3/2018 Wei D15/199
D813,285 S * 3/2018 Wei D15/199
D817,375 S * 5/2018 Deyle D15/199
D820,334 S * 6/2018 Lee D15/199
D826,303 S * 8/2018 Metta D15/199
D839,334 S * 1/2019 Chen D15/199
D871,474 S * 12/2019 Kolb D15/199
D884,764 S * 5/2020 Mori D15/199
D884,765 S * 5/2020 Mori D15/199
2007/0132419 A1 * 6/2007 Hashimoto B25J 5/007
318/568.12
2008/0147261 A1 * 6/2008 Ichinose G01C 22/006
701/24
2009/0169347 A1 * 7/2009 Teng B25J 19/005
414/401
2015/0190927 A1 * 7/2015 Sutherland B25J 11/009
700/259
2018/0178375 A1 * 6/2018 Yang B25J 19/00

* cited by examiner

1.1

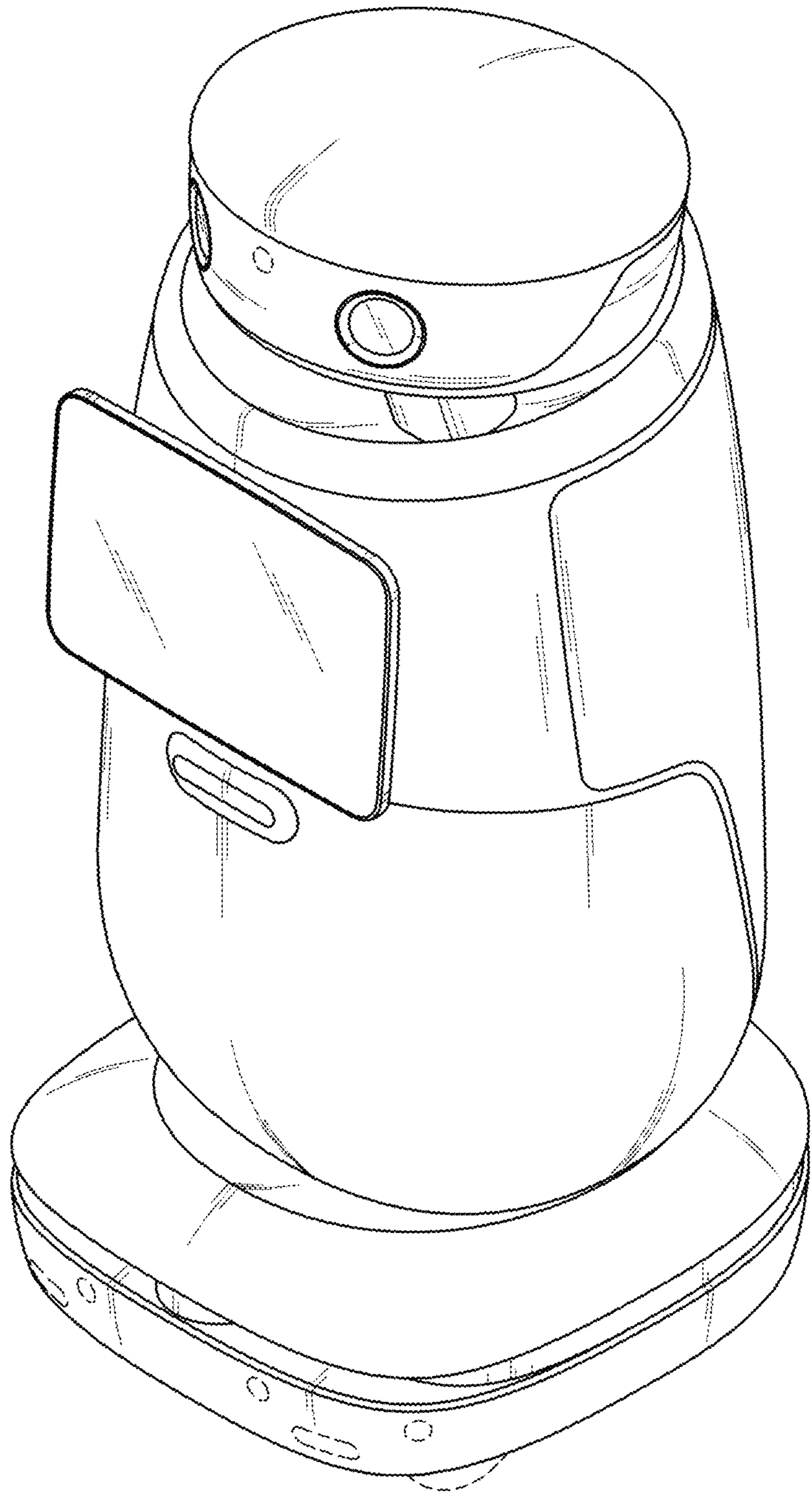

1.2

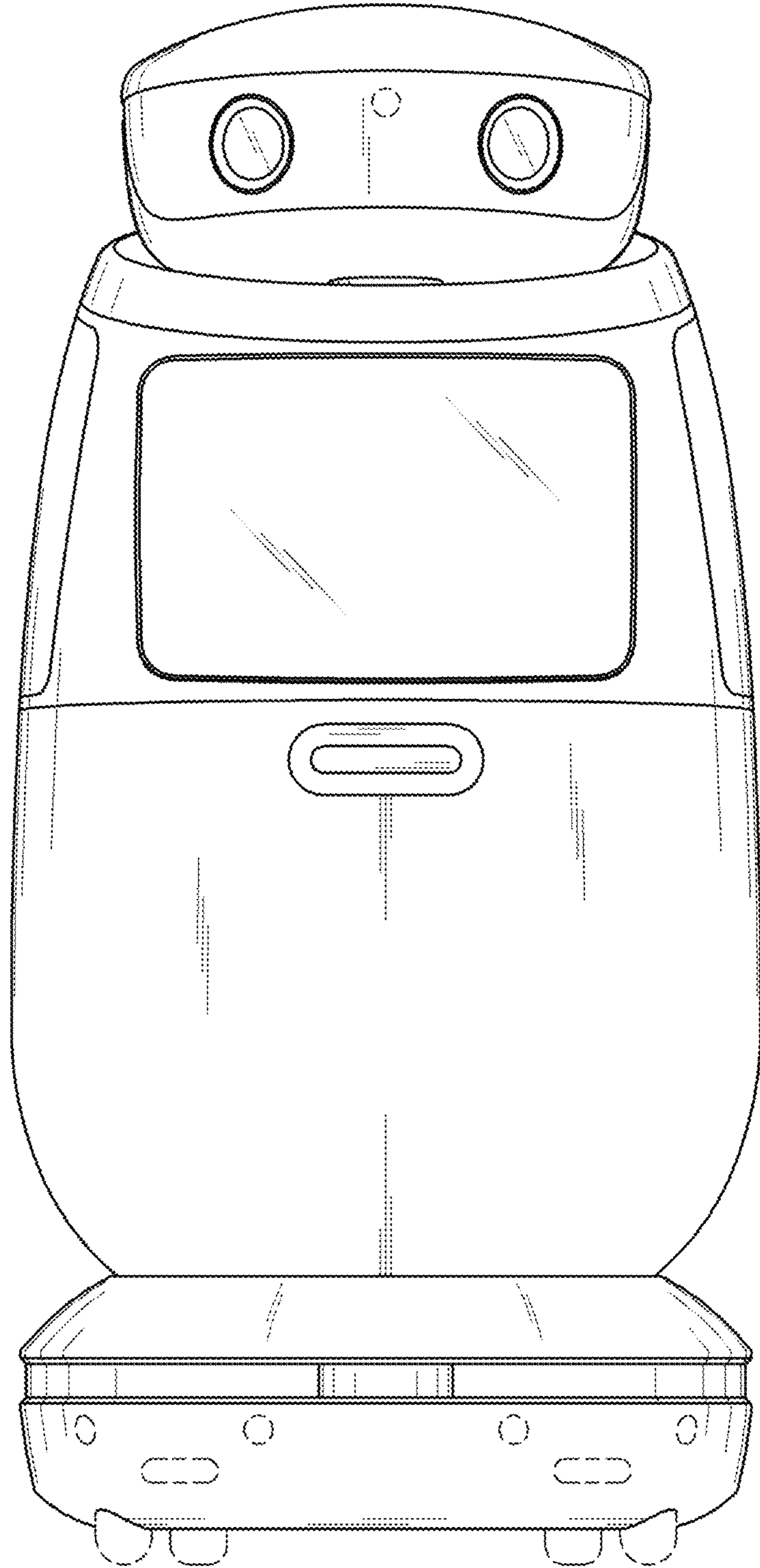

1.3

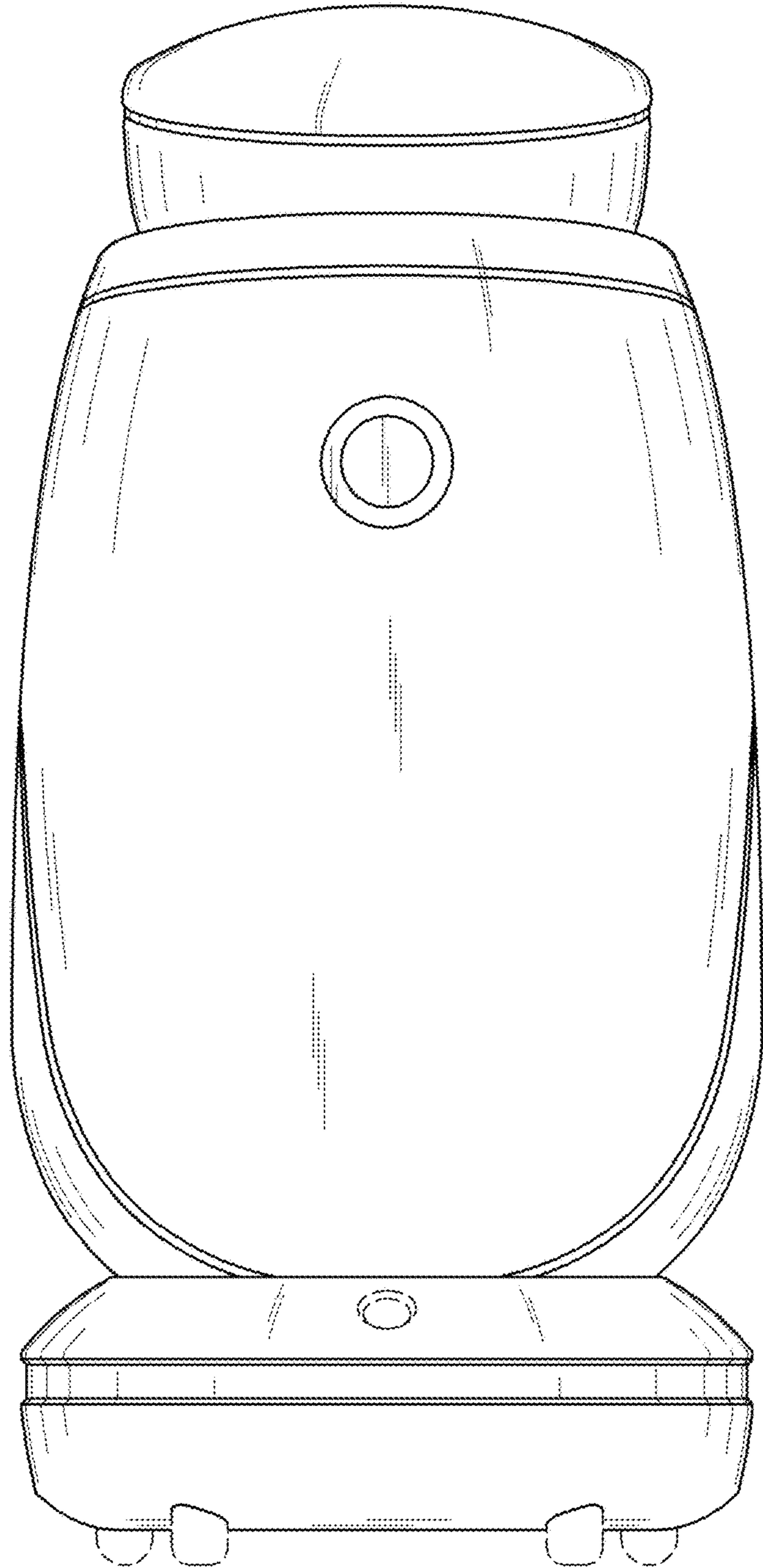

1.4

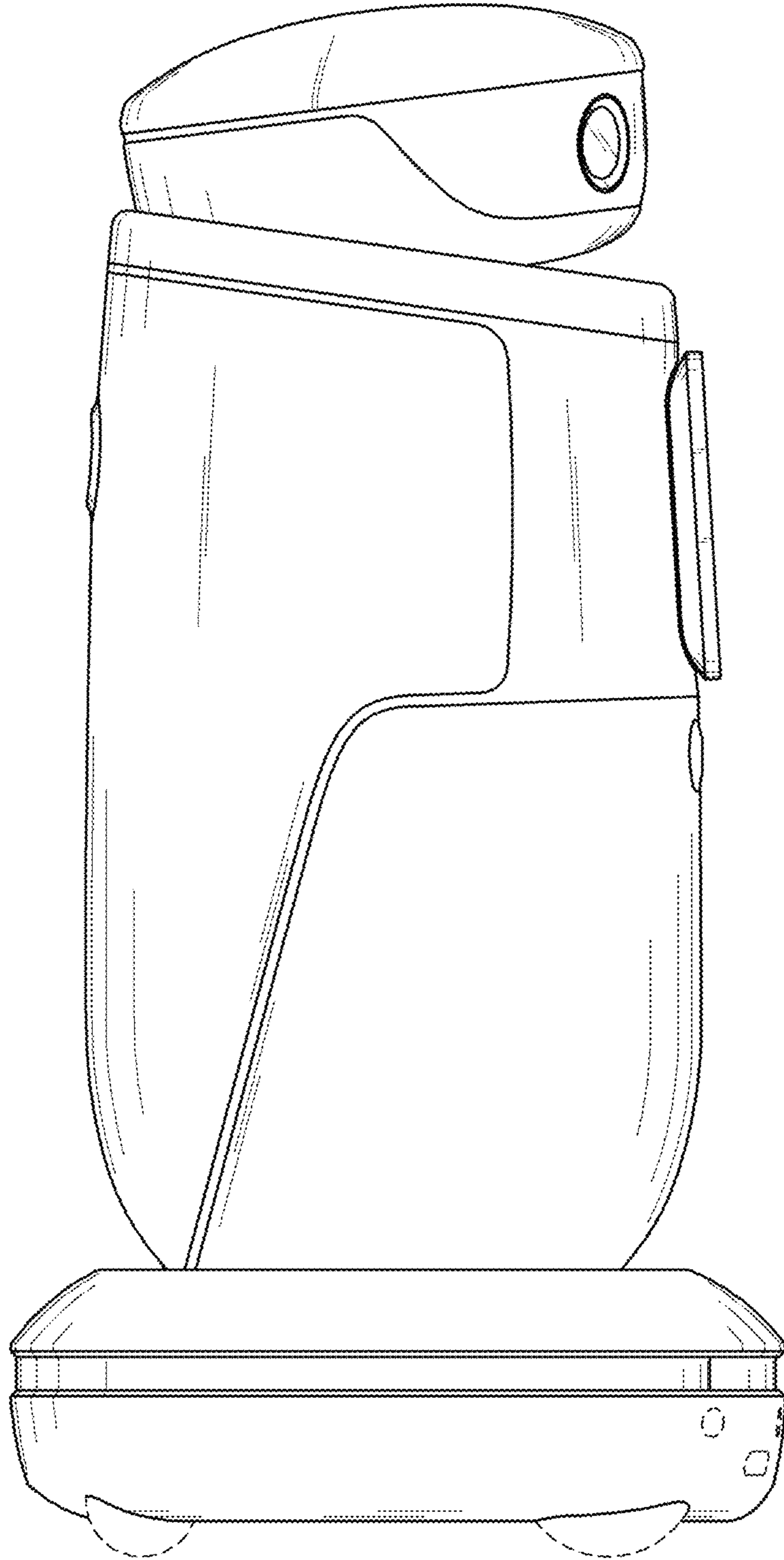

1.5

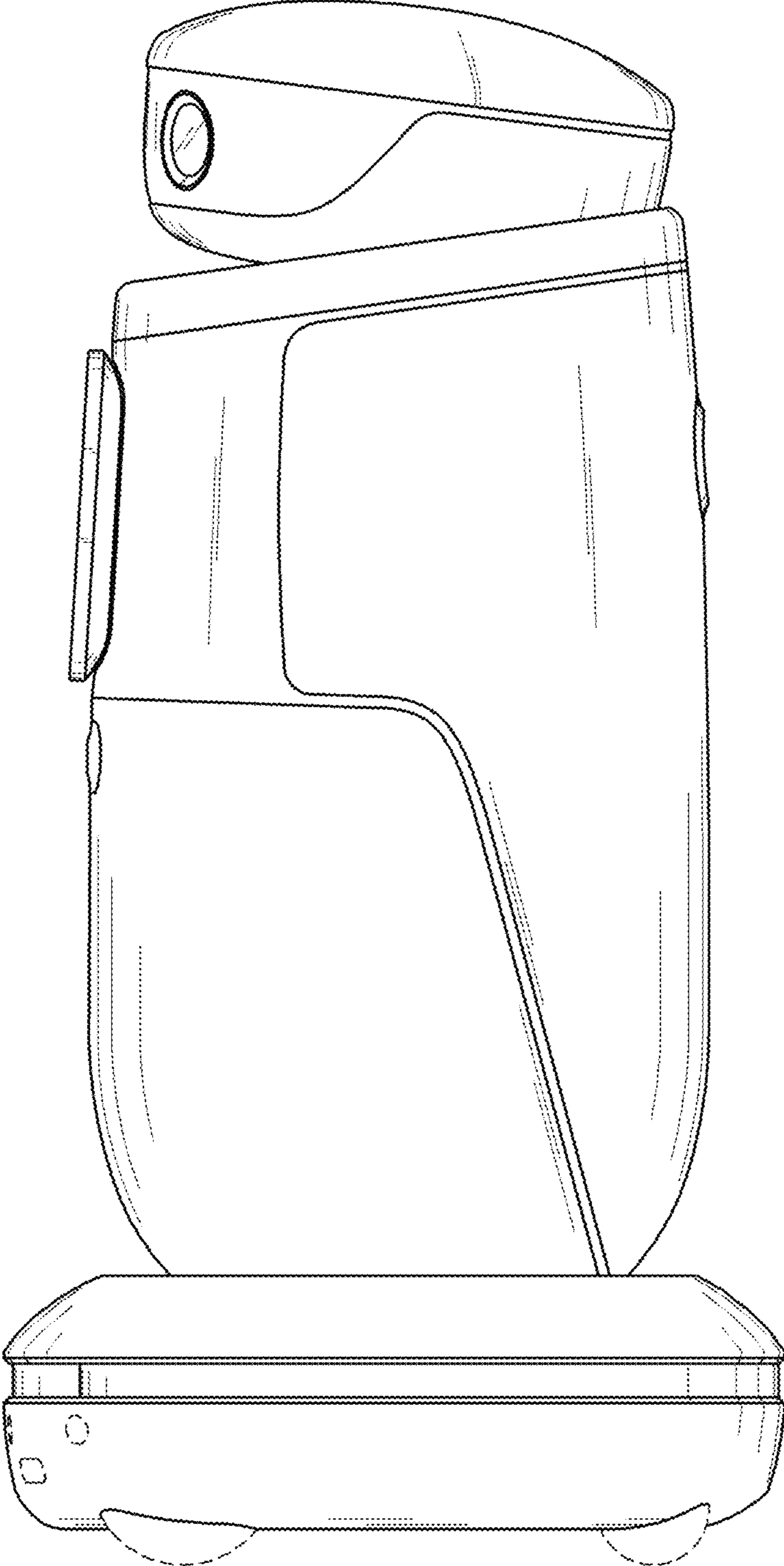

1.6

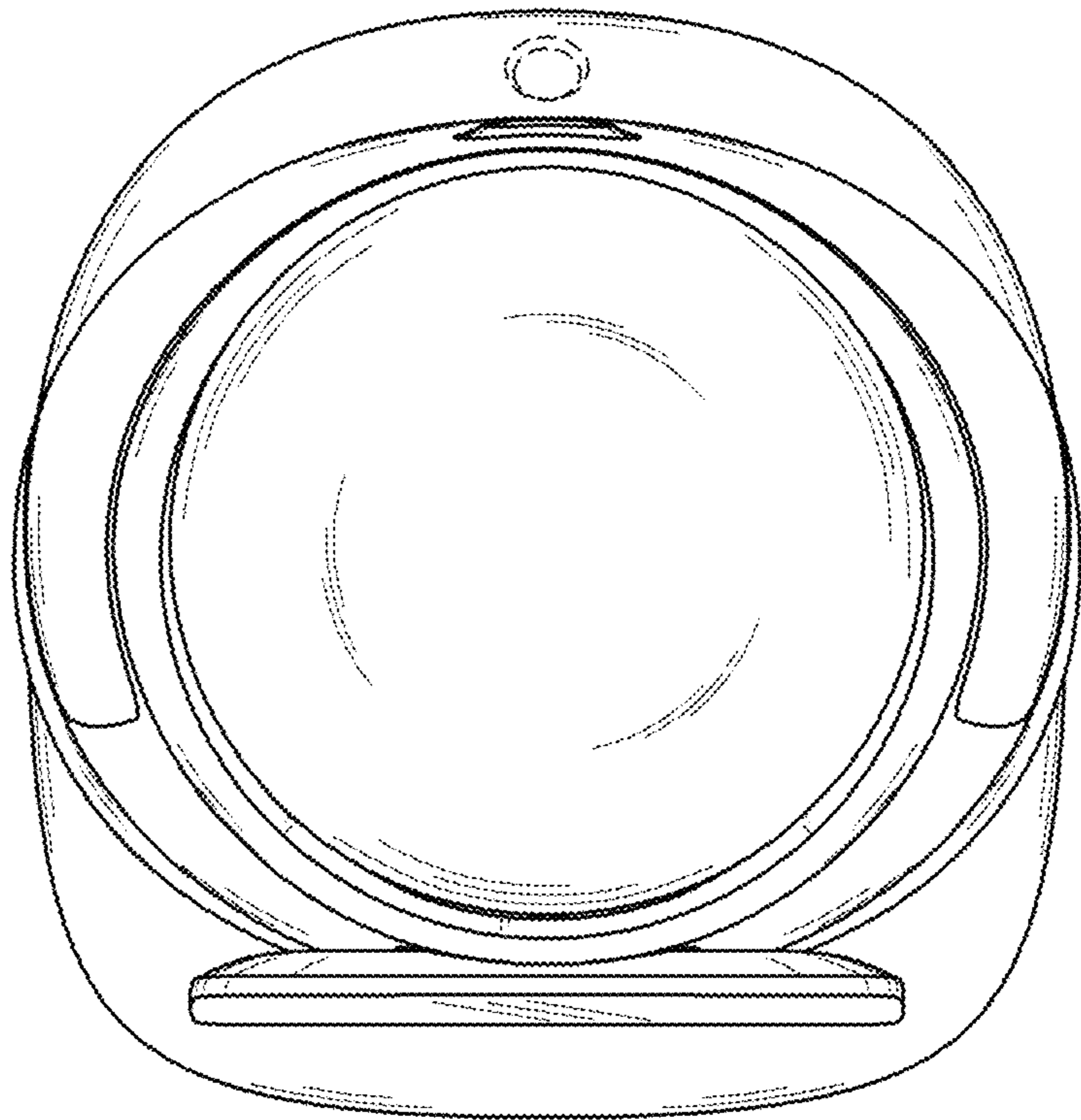

1.7

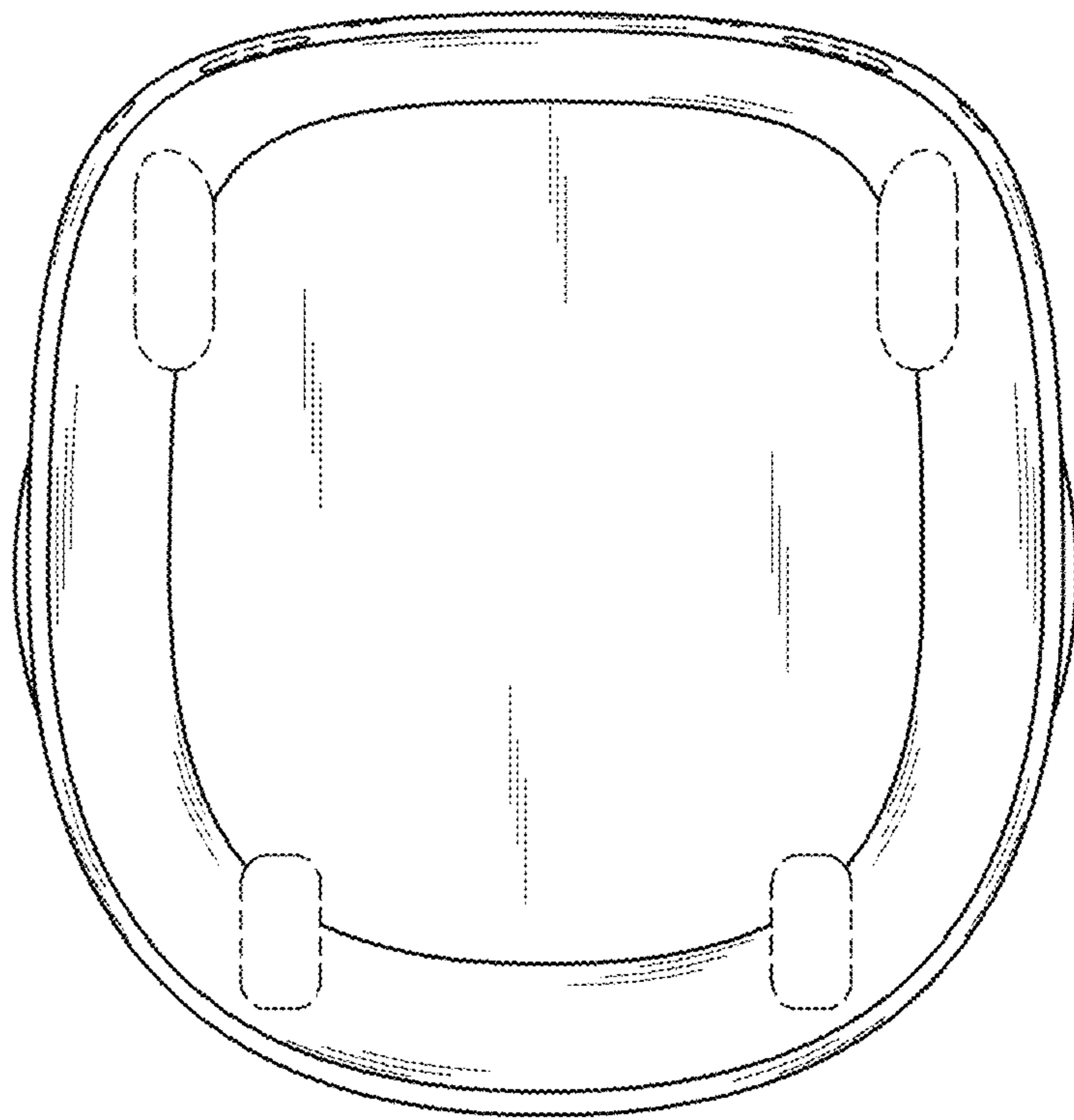

1.8

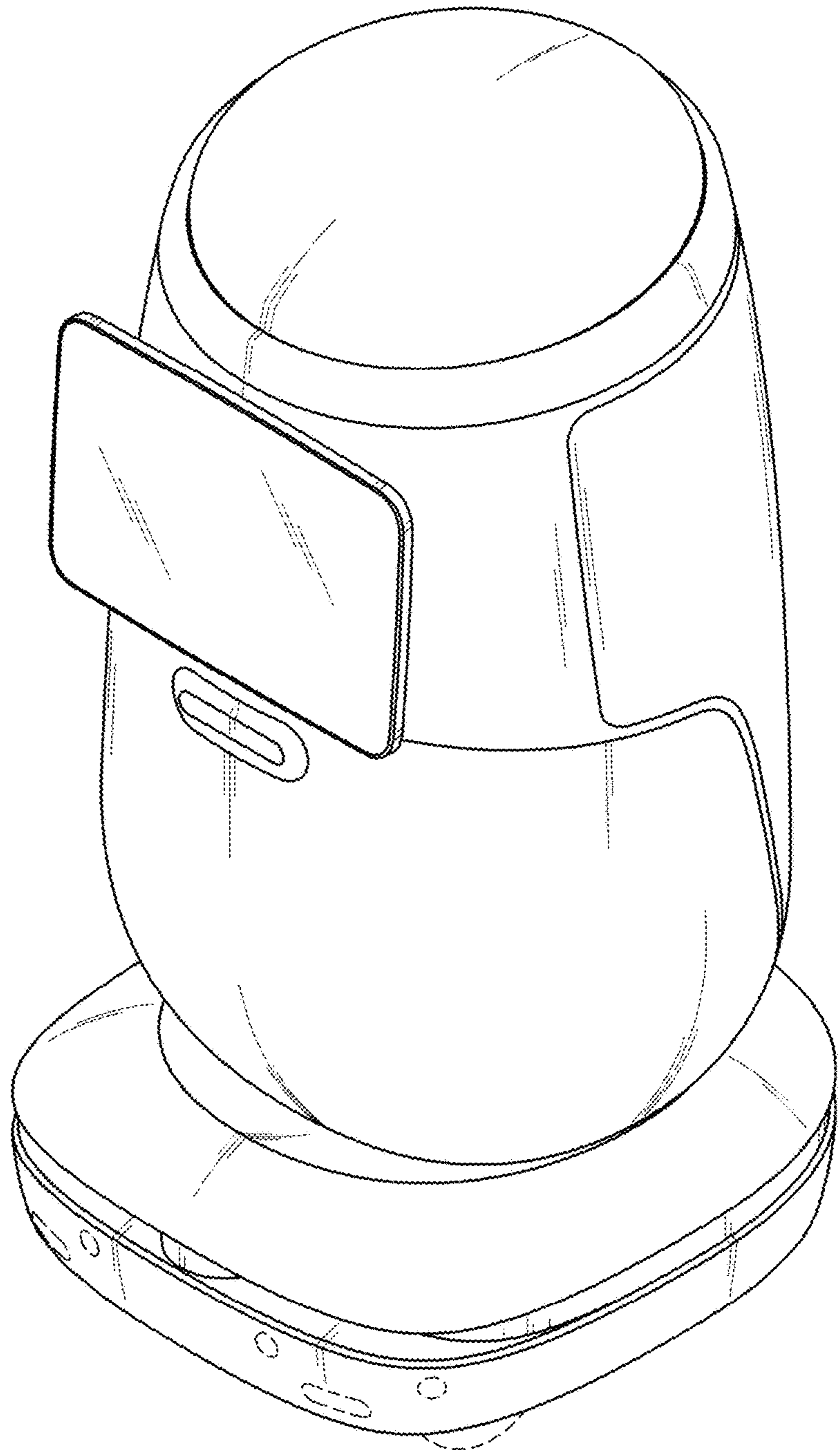

1.9

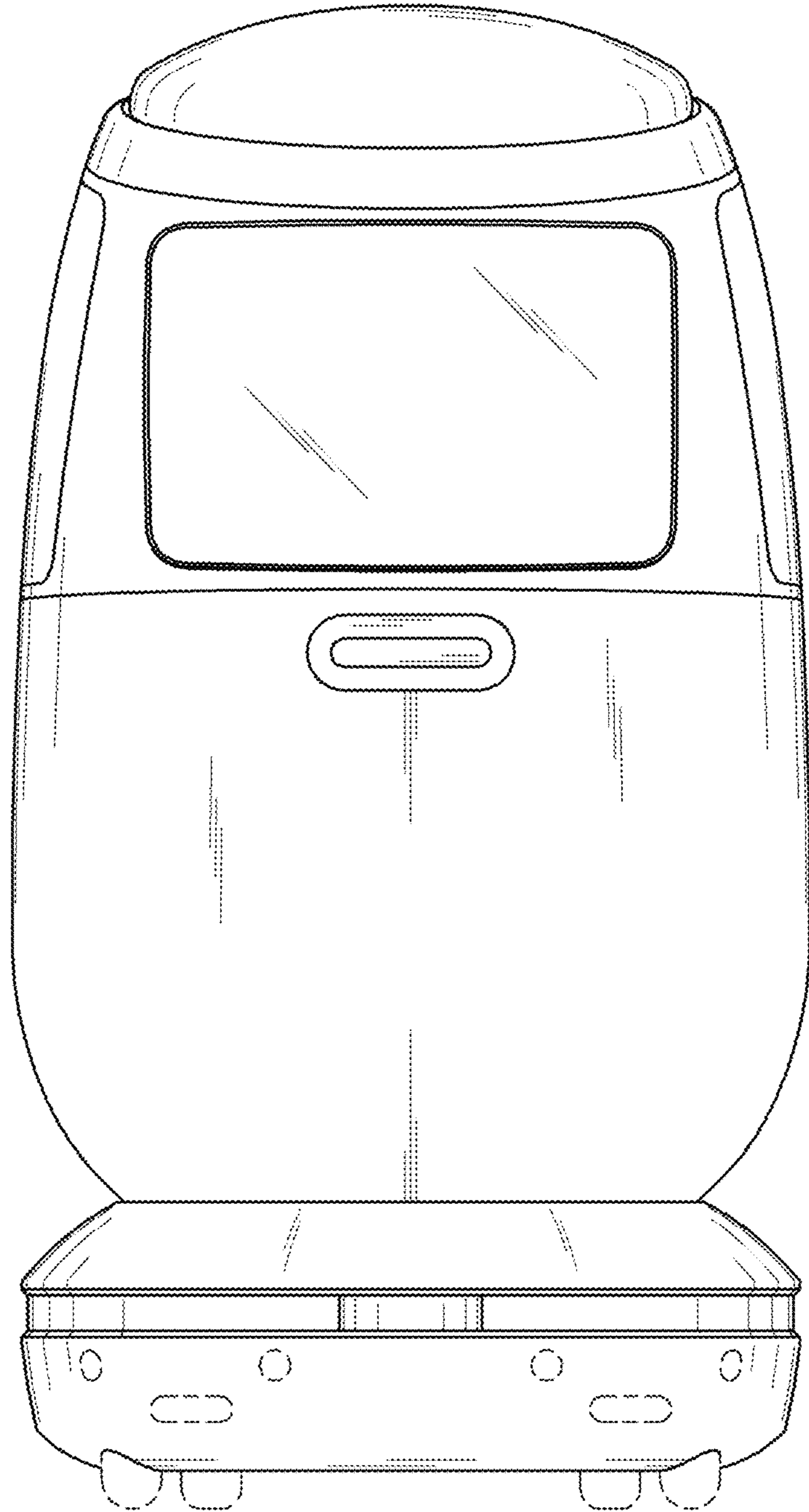

1.10

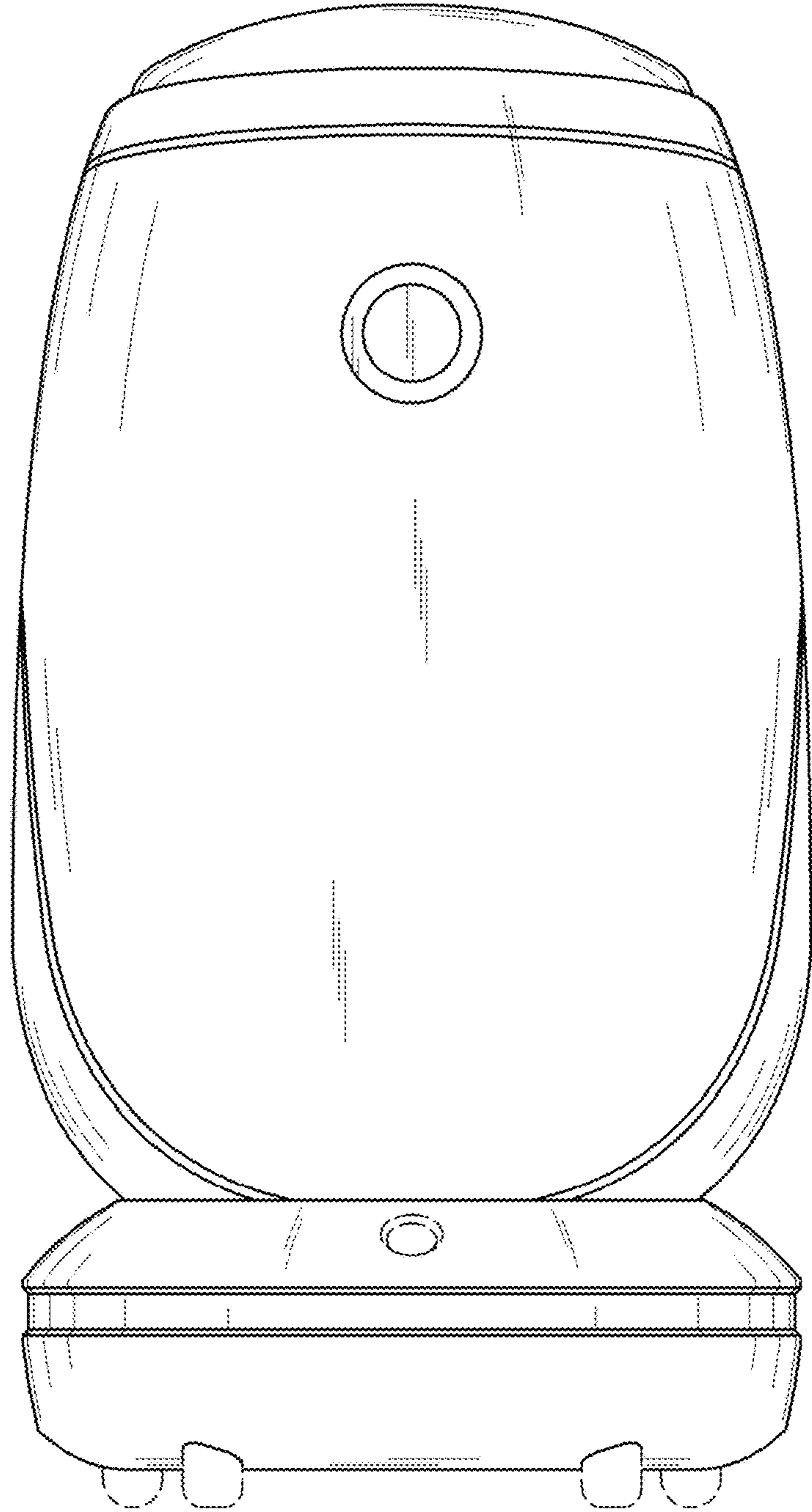

1.11

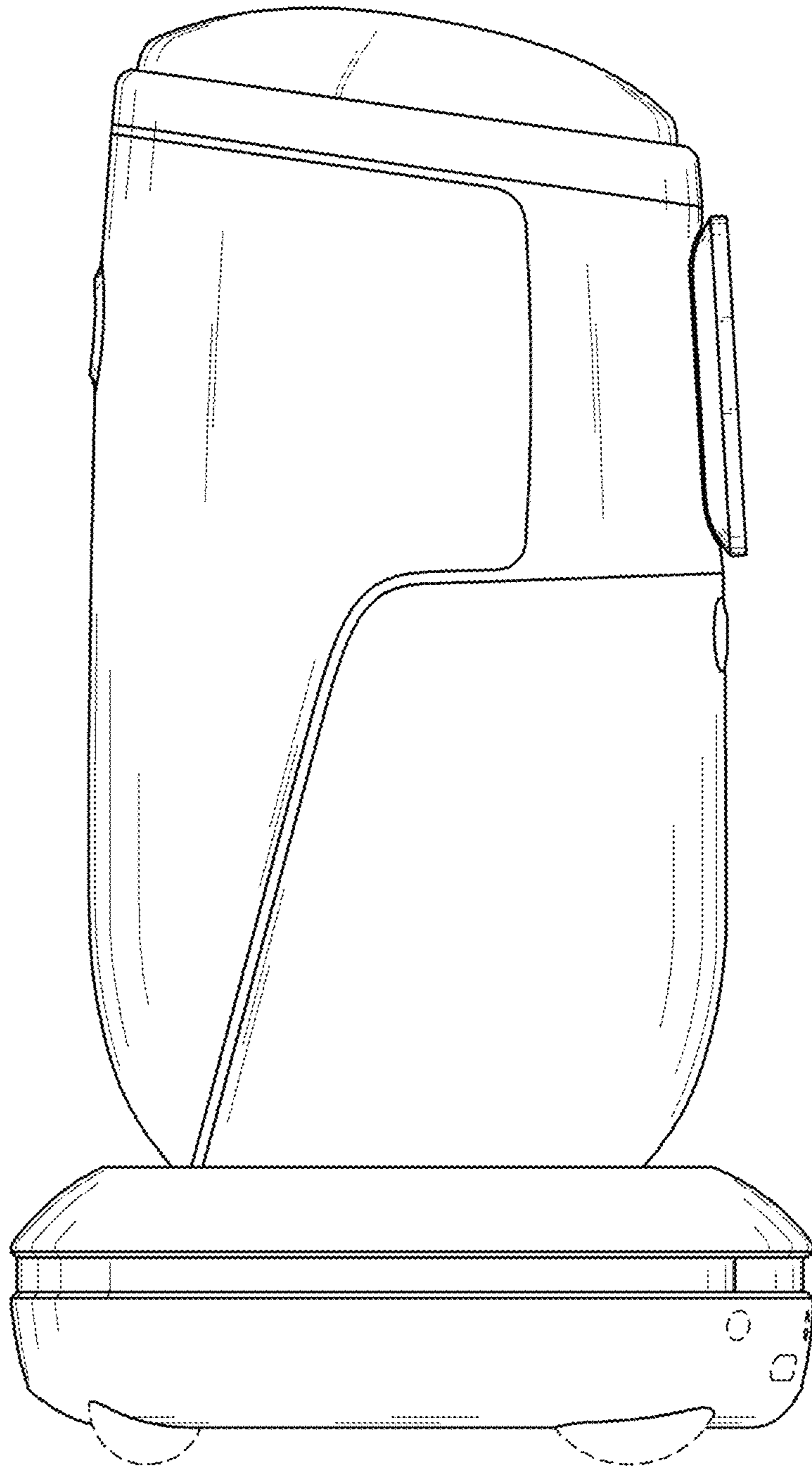

1.12

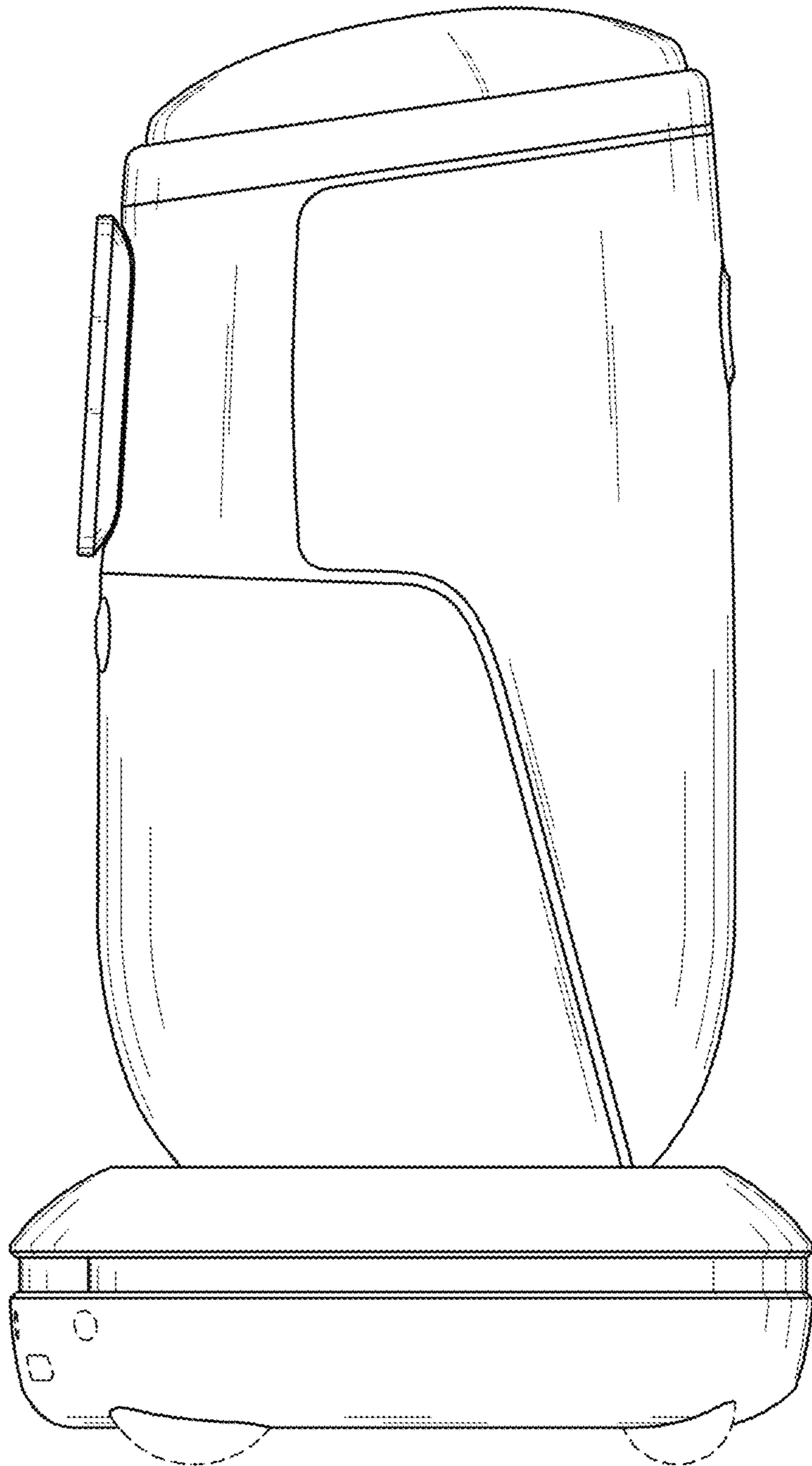

1.13

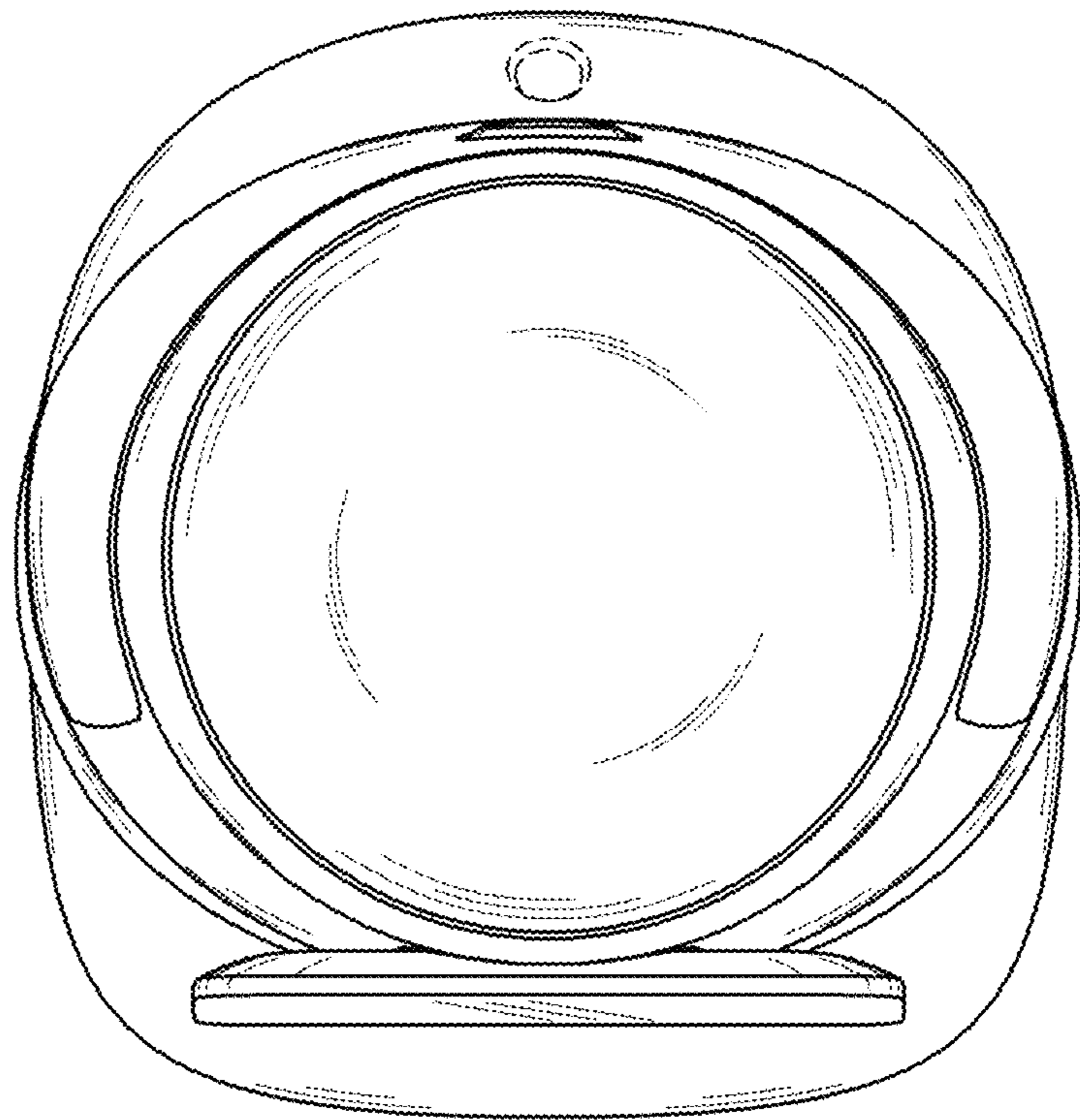

1.14

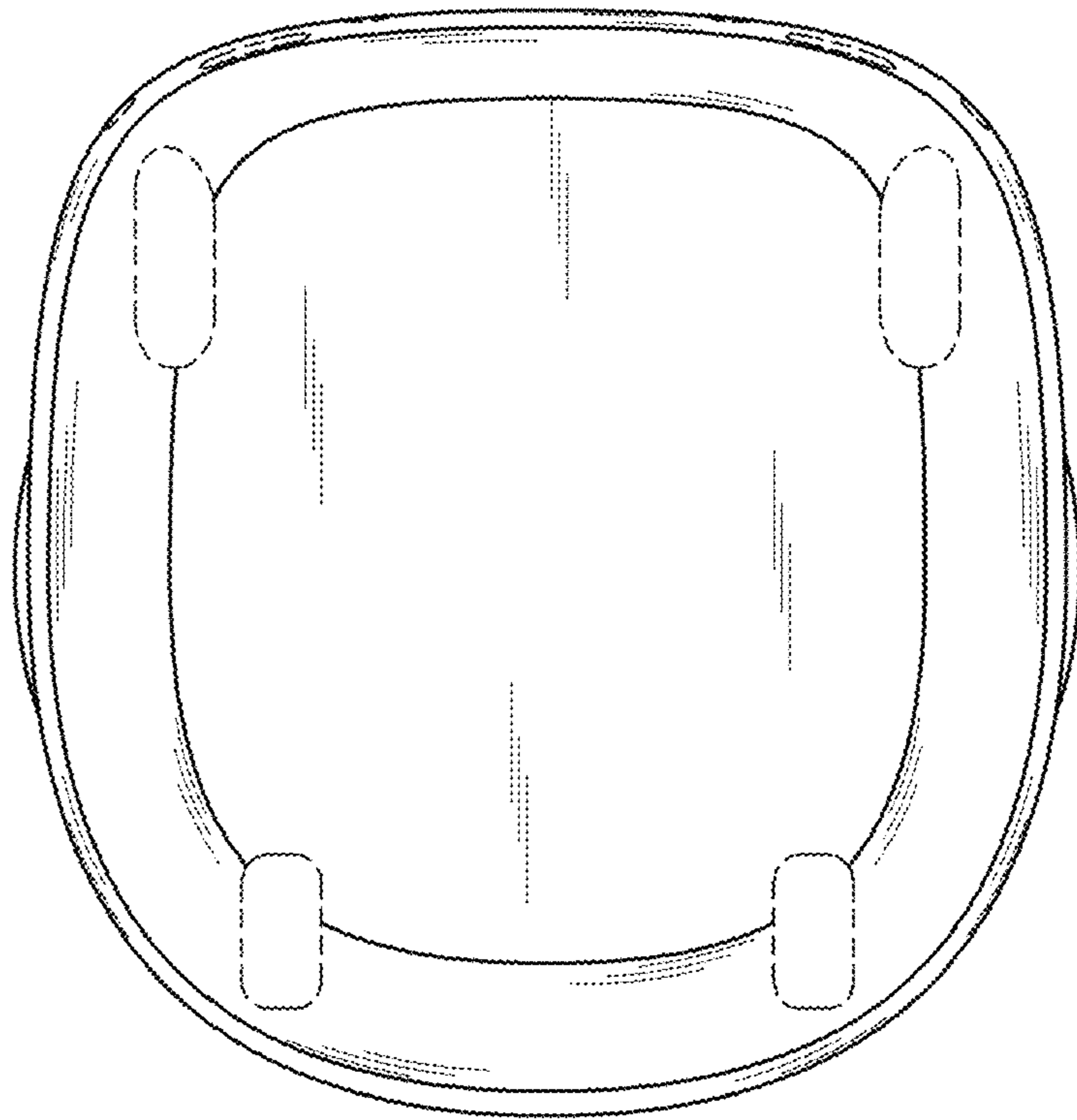

1.15

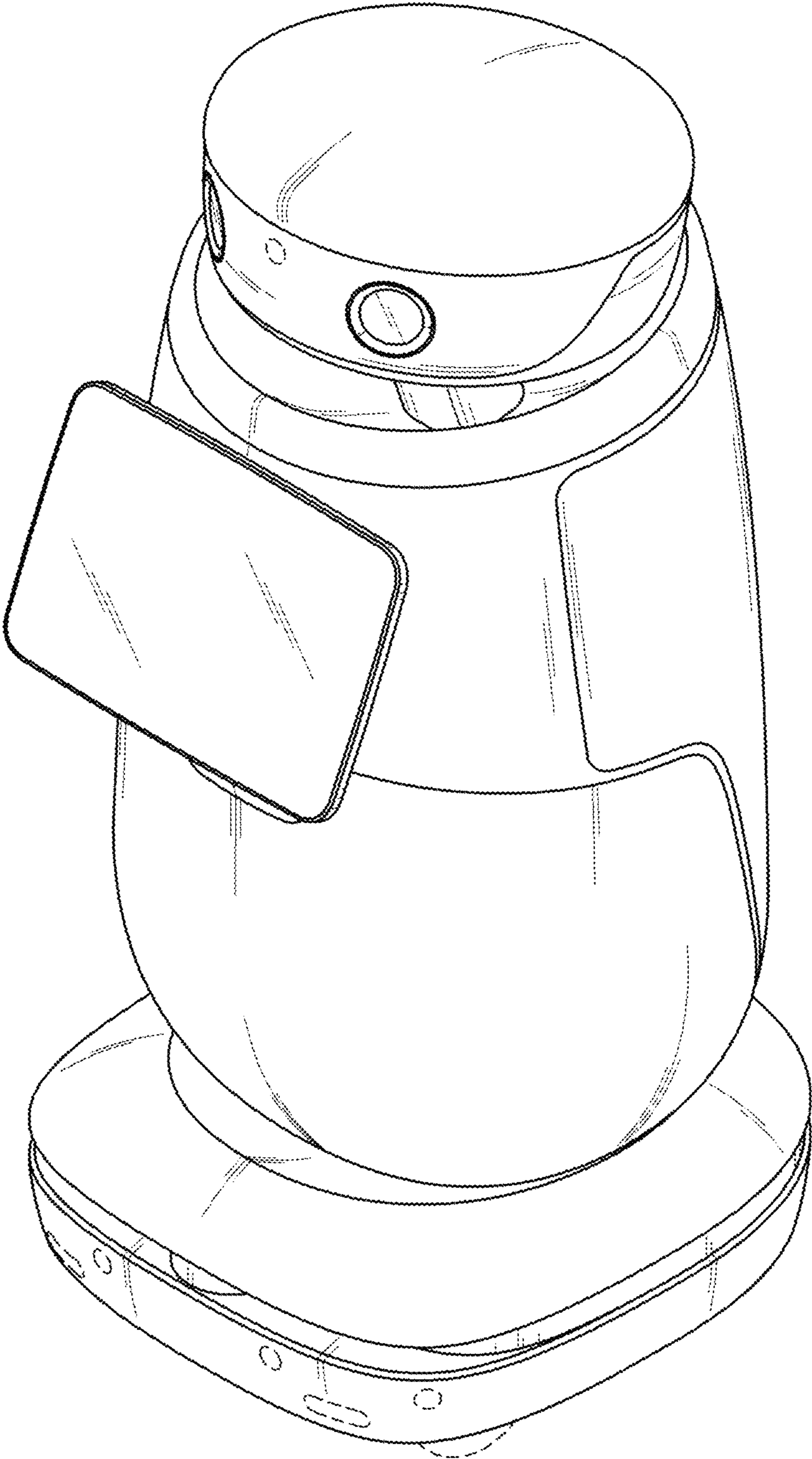

1.16

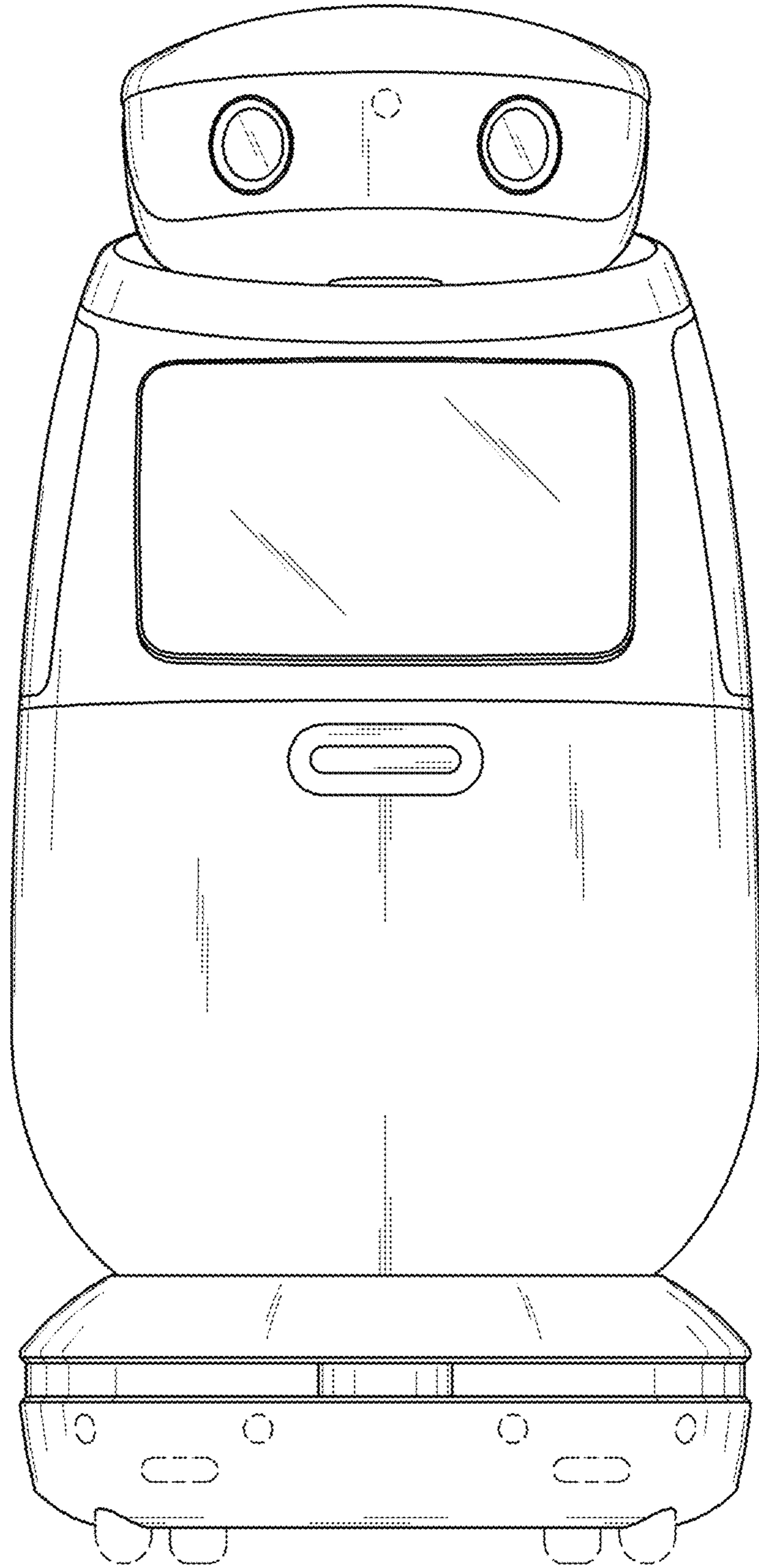

1.17

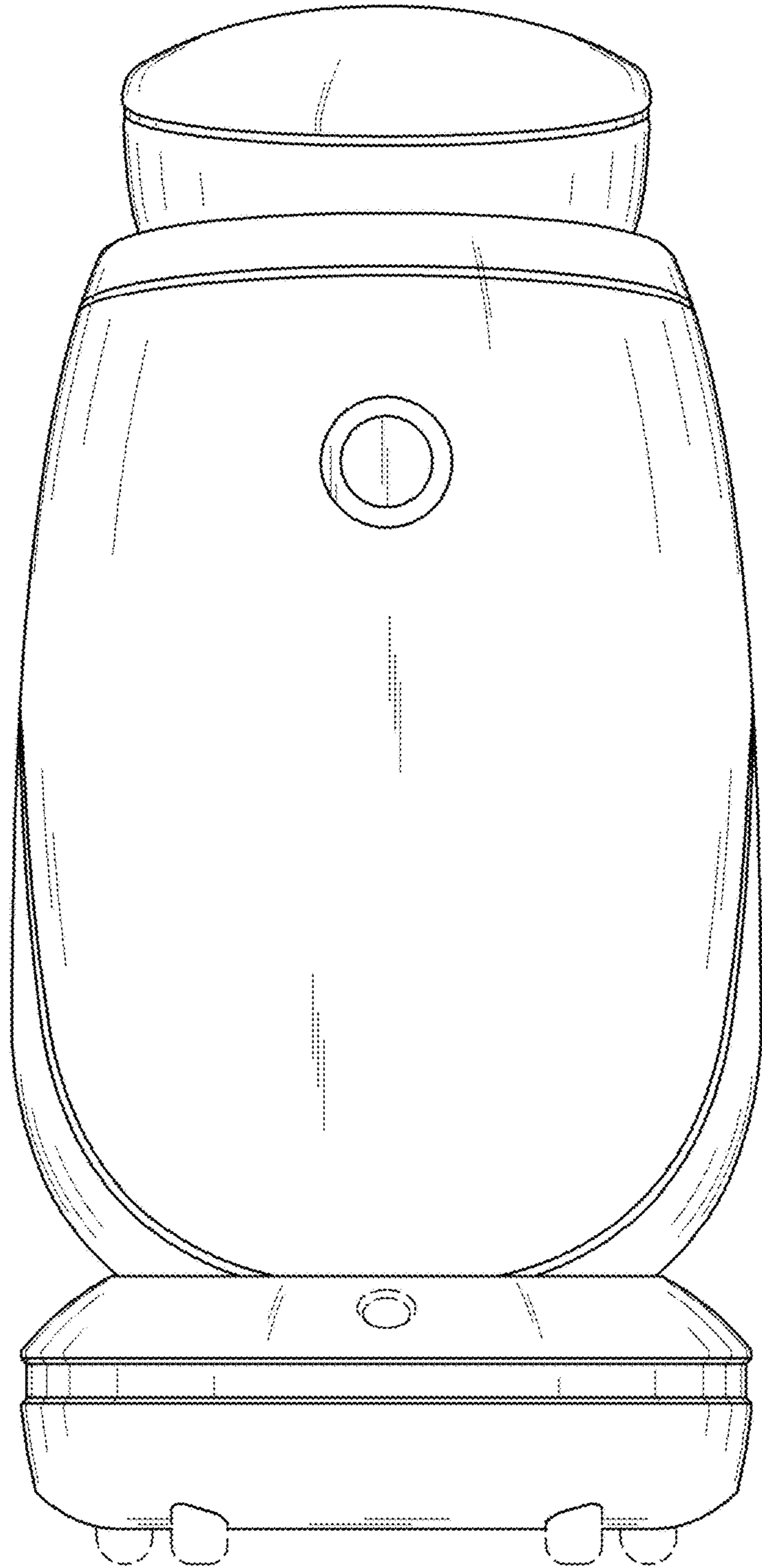

1.18

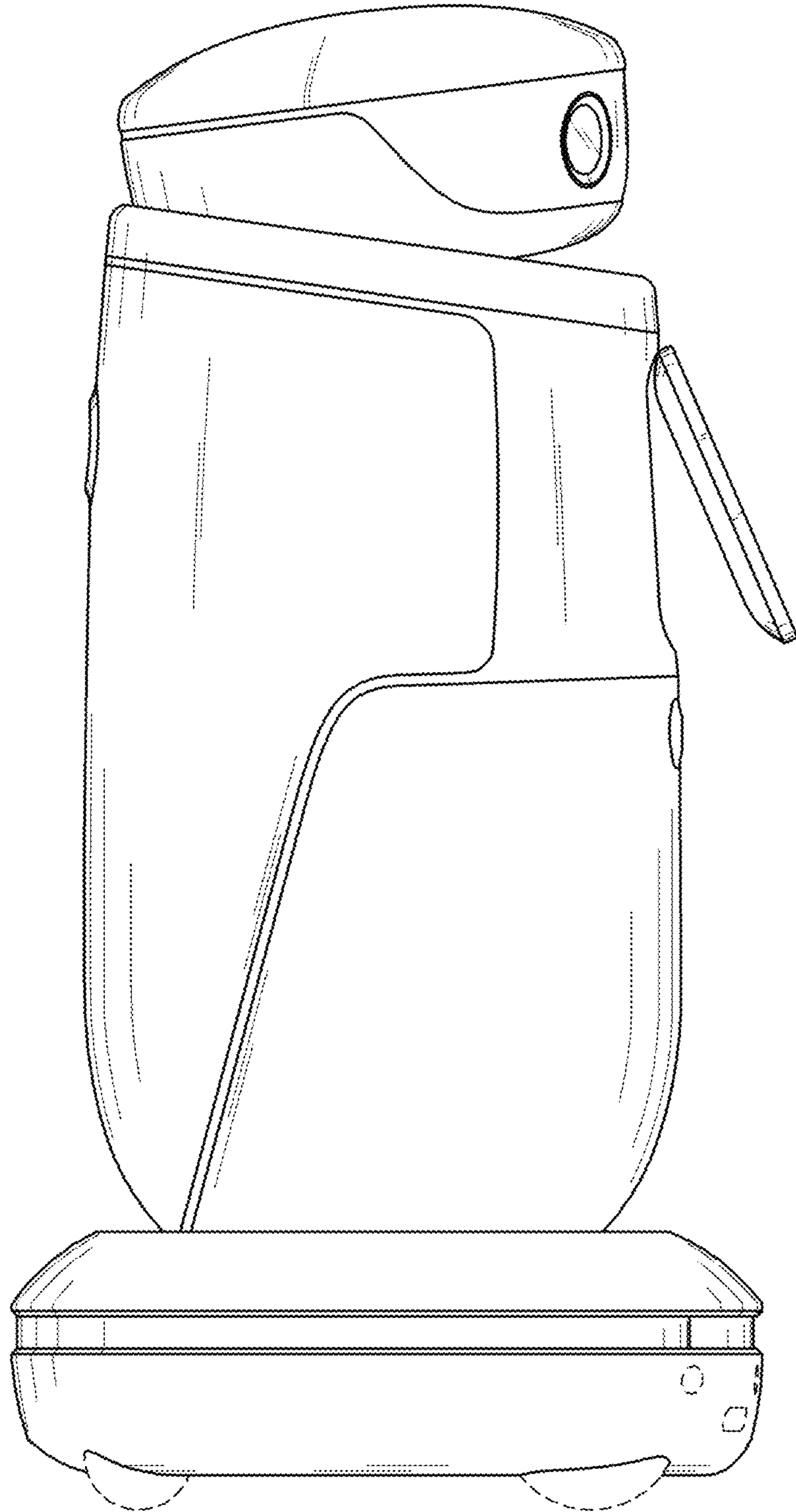

1.19

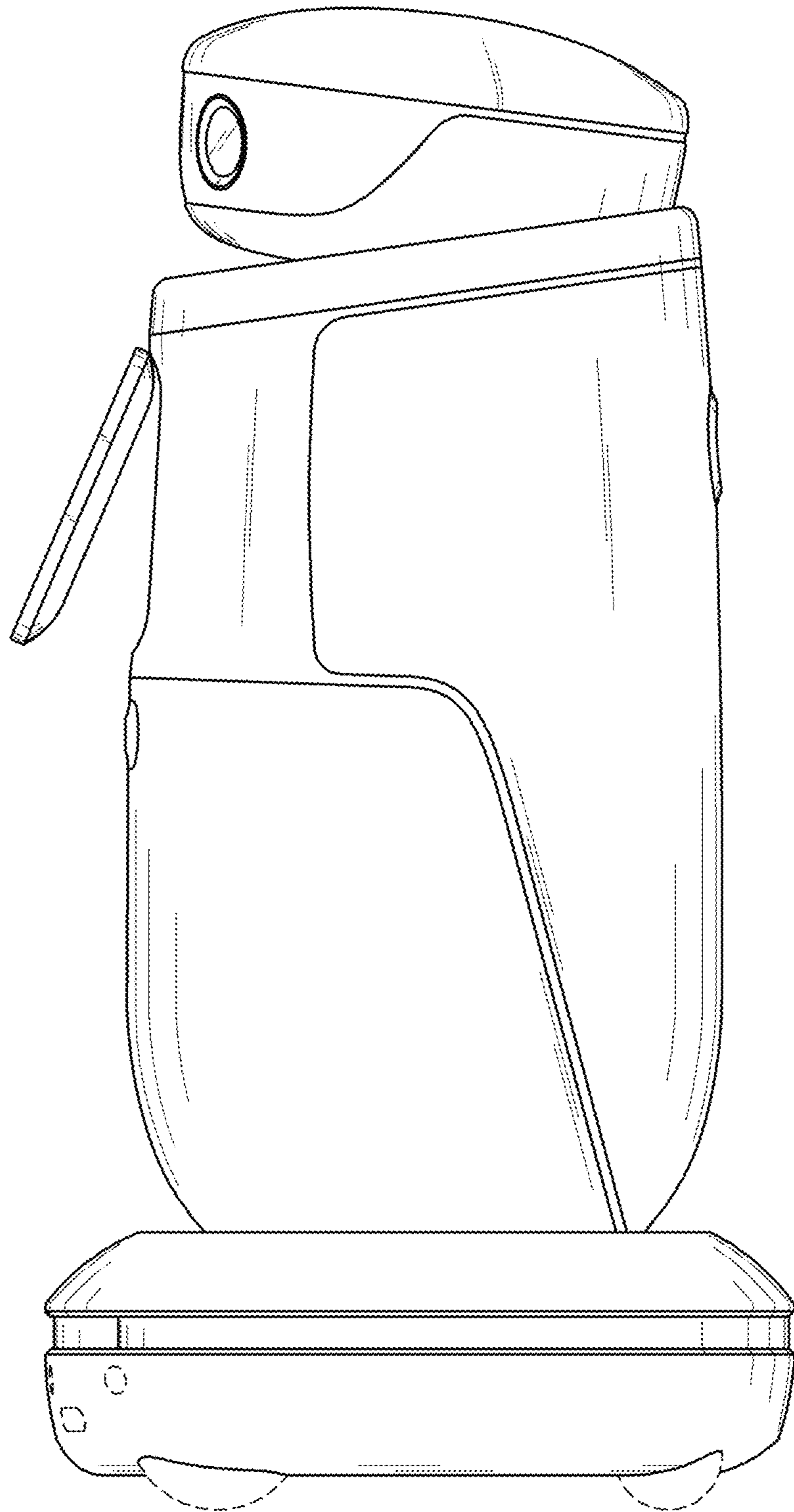

1.20

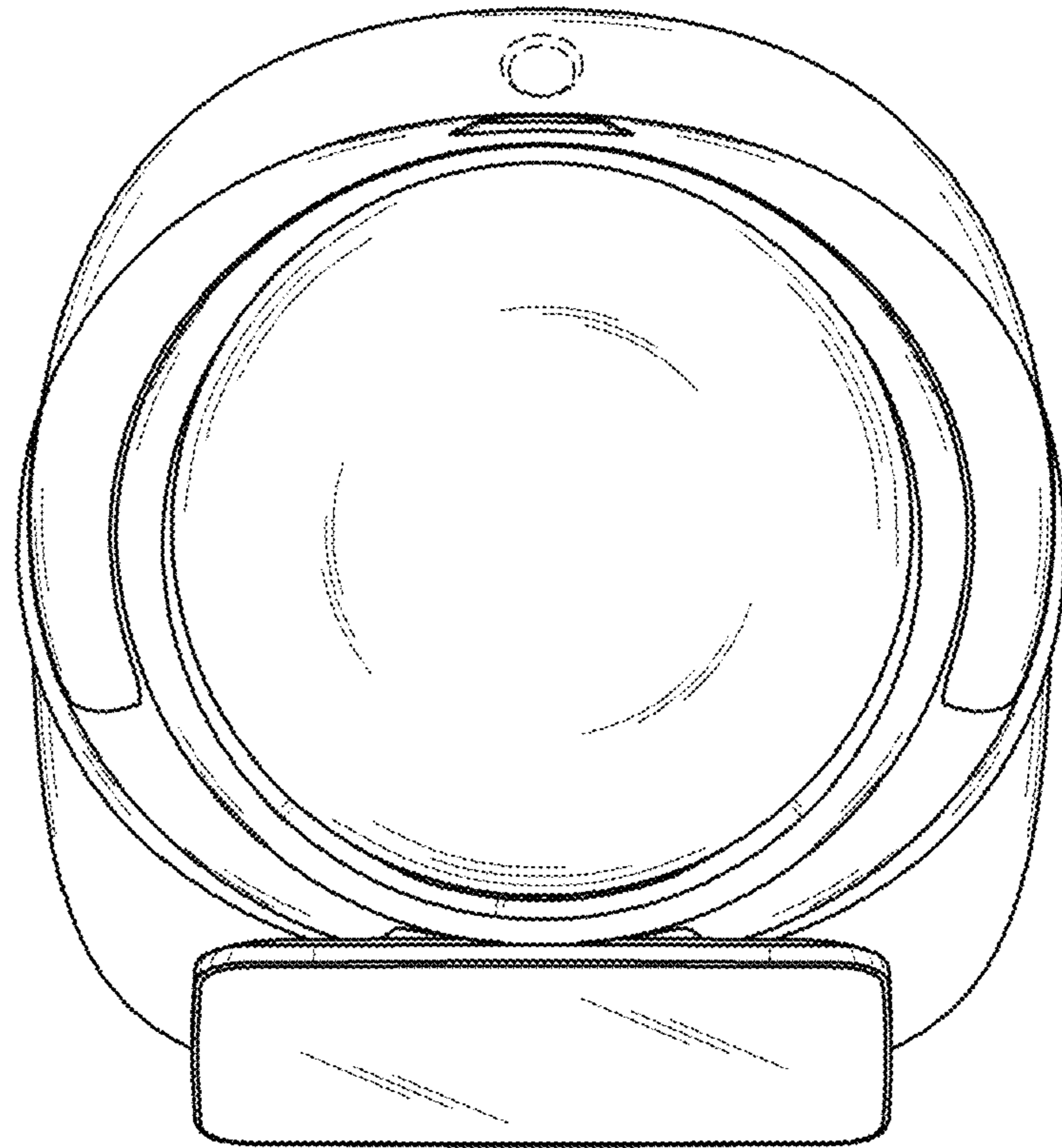

1.21

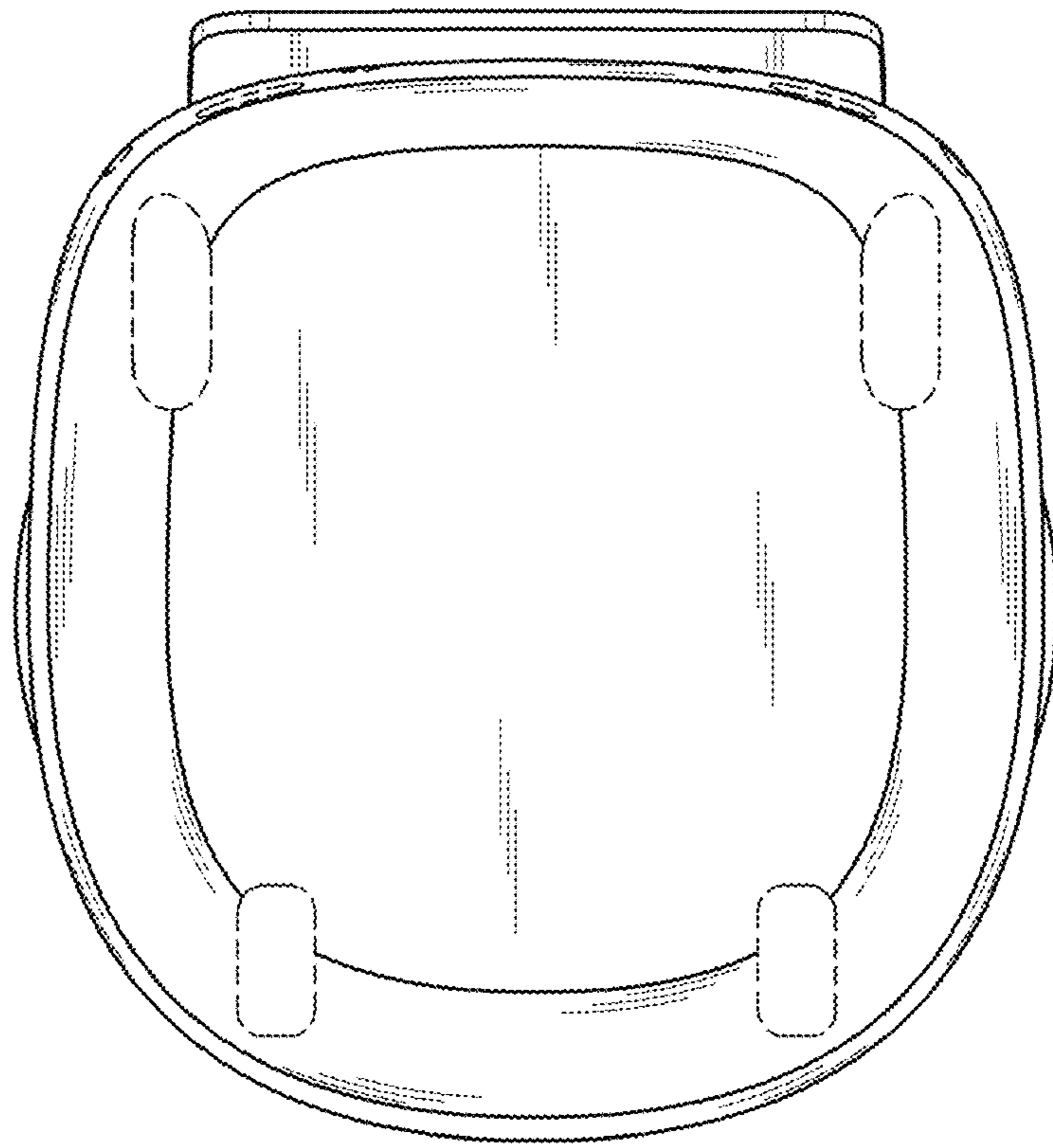

1.22

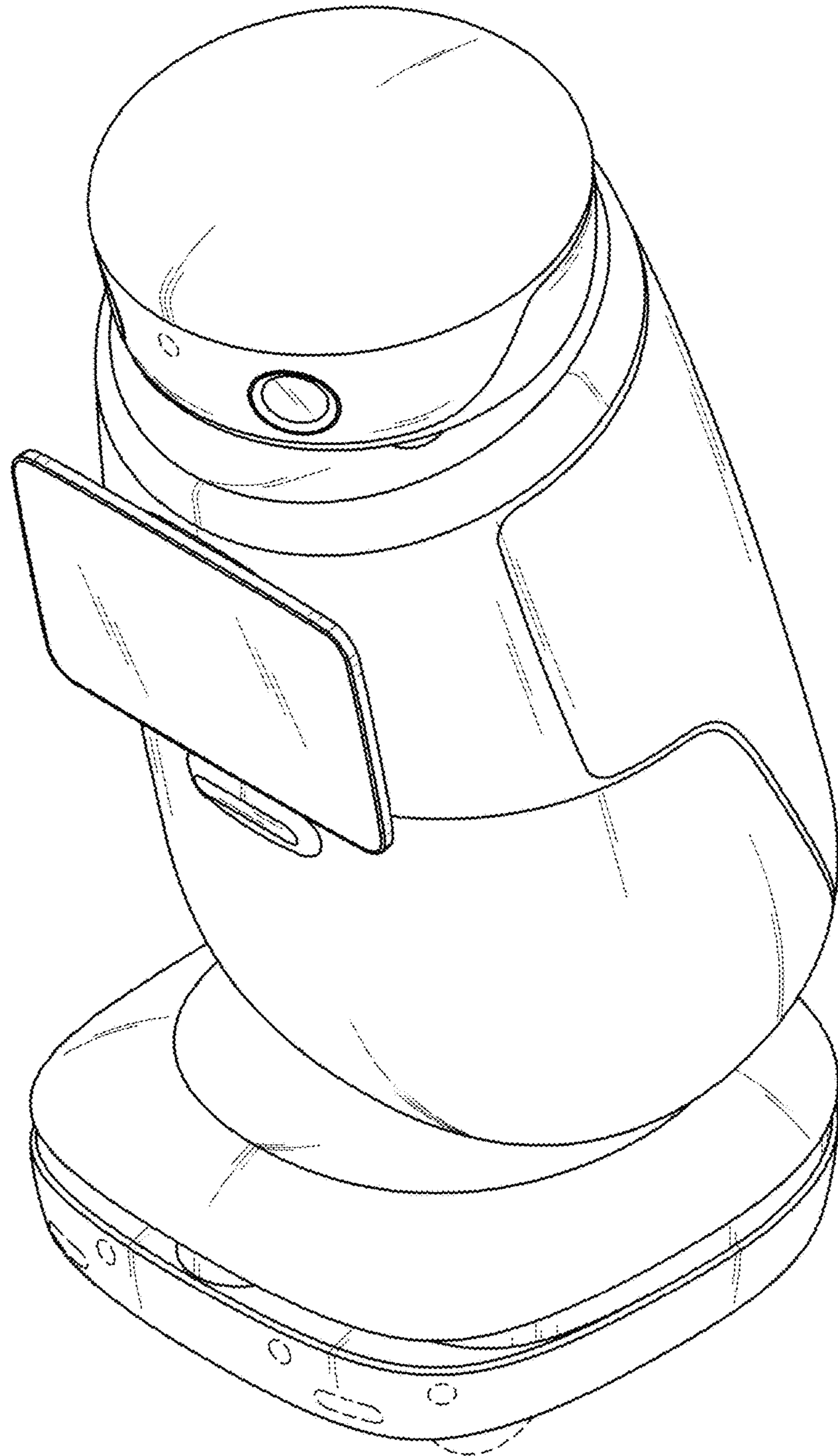

1.23

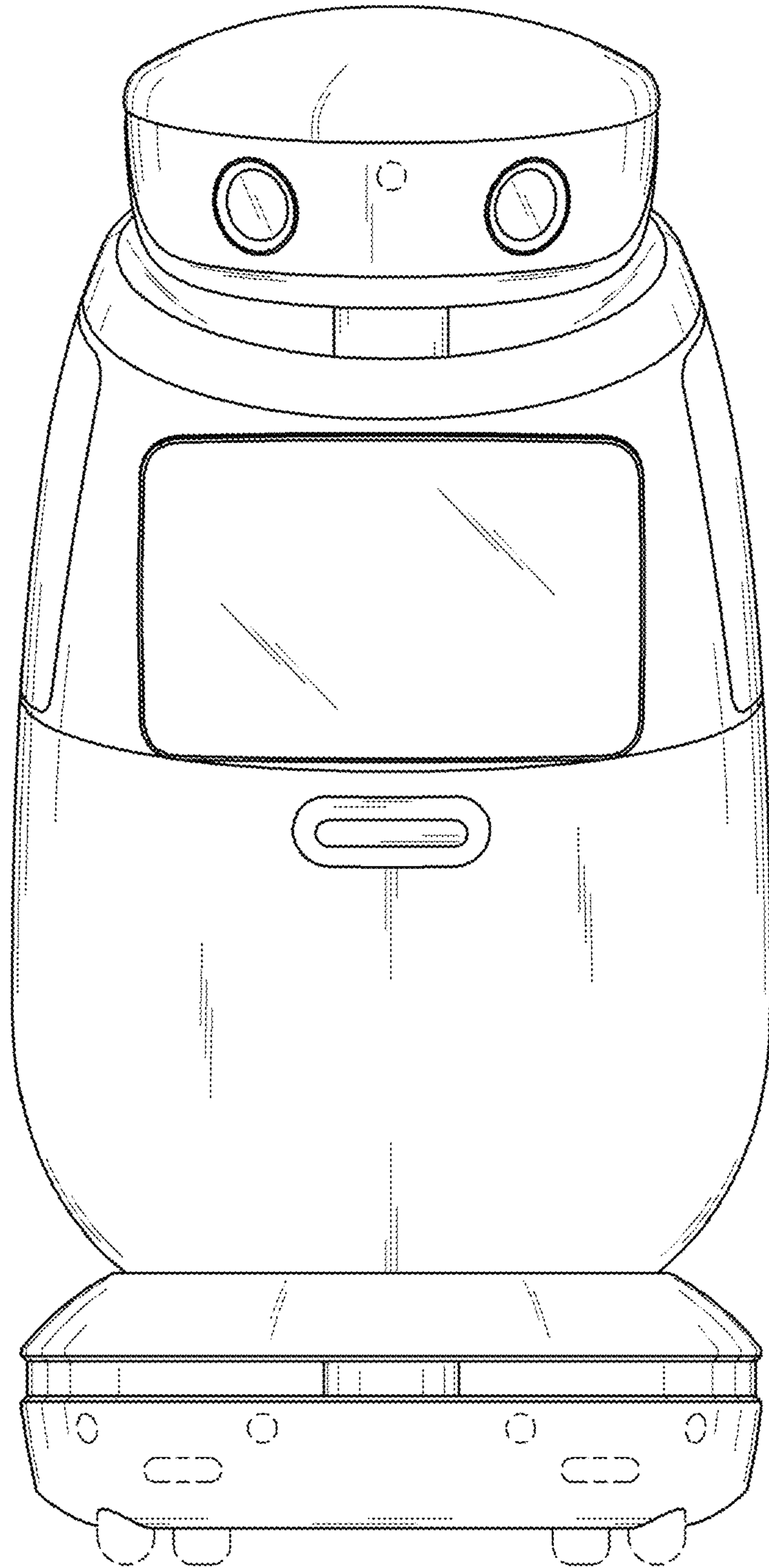

1.24

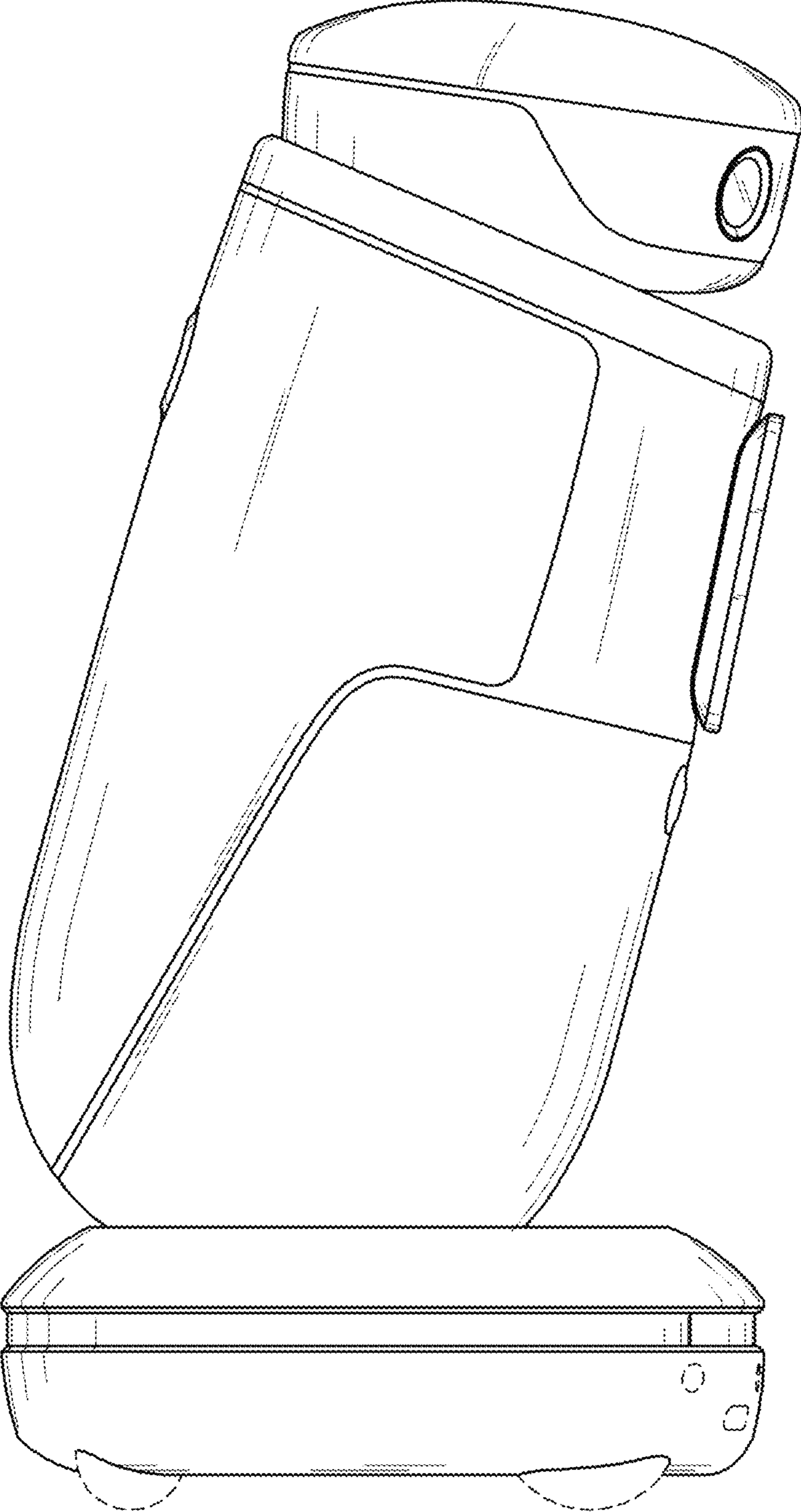

1.25

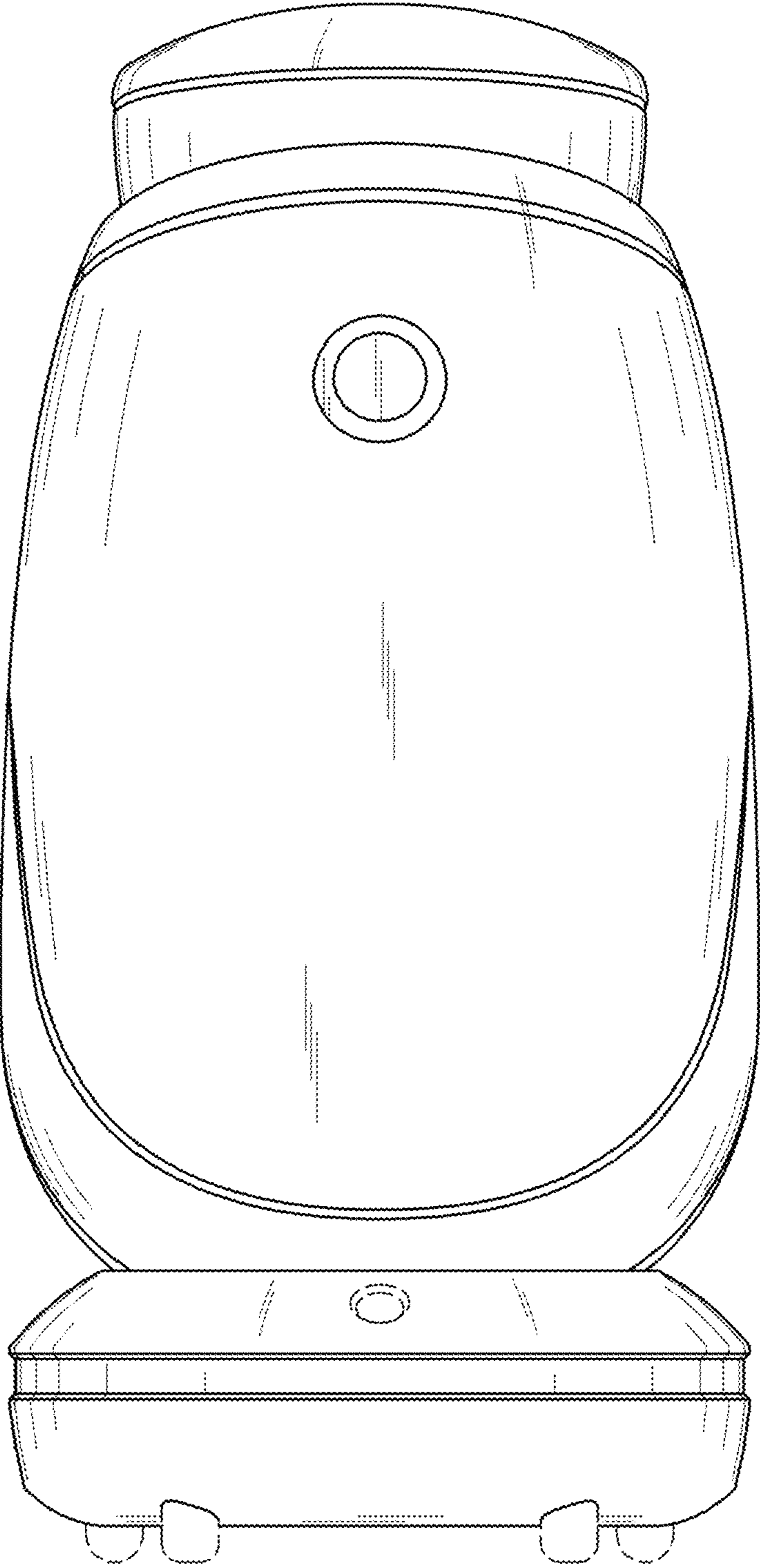

1.26

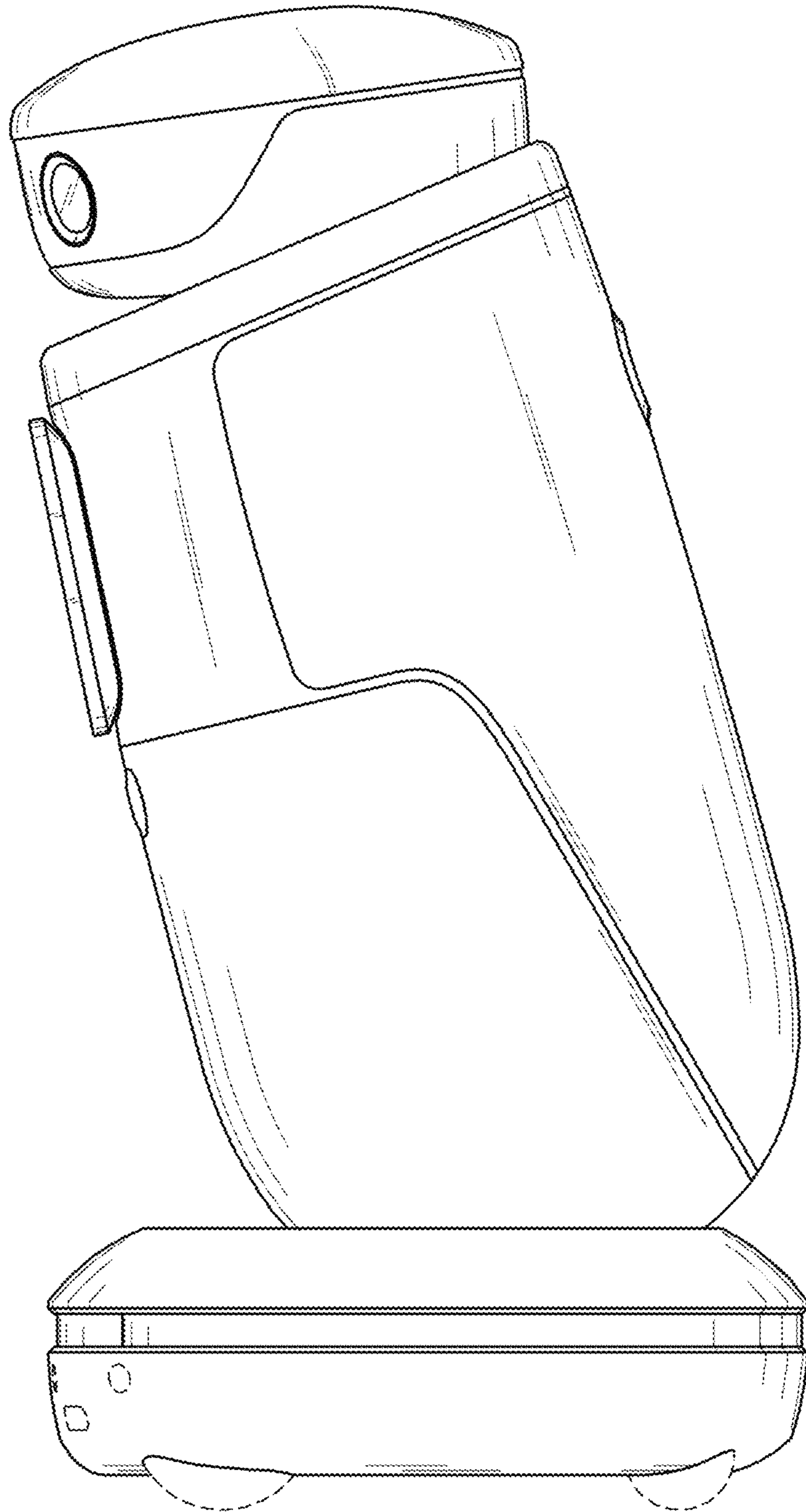

1.27

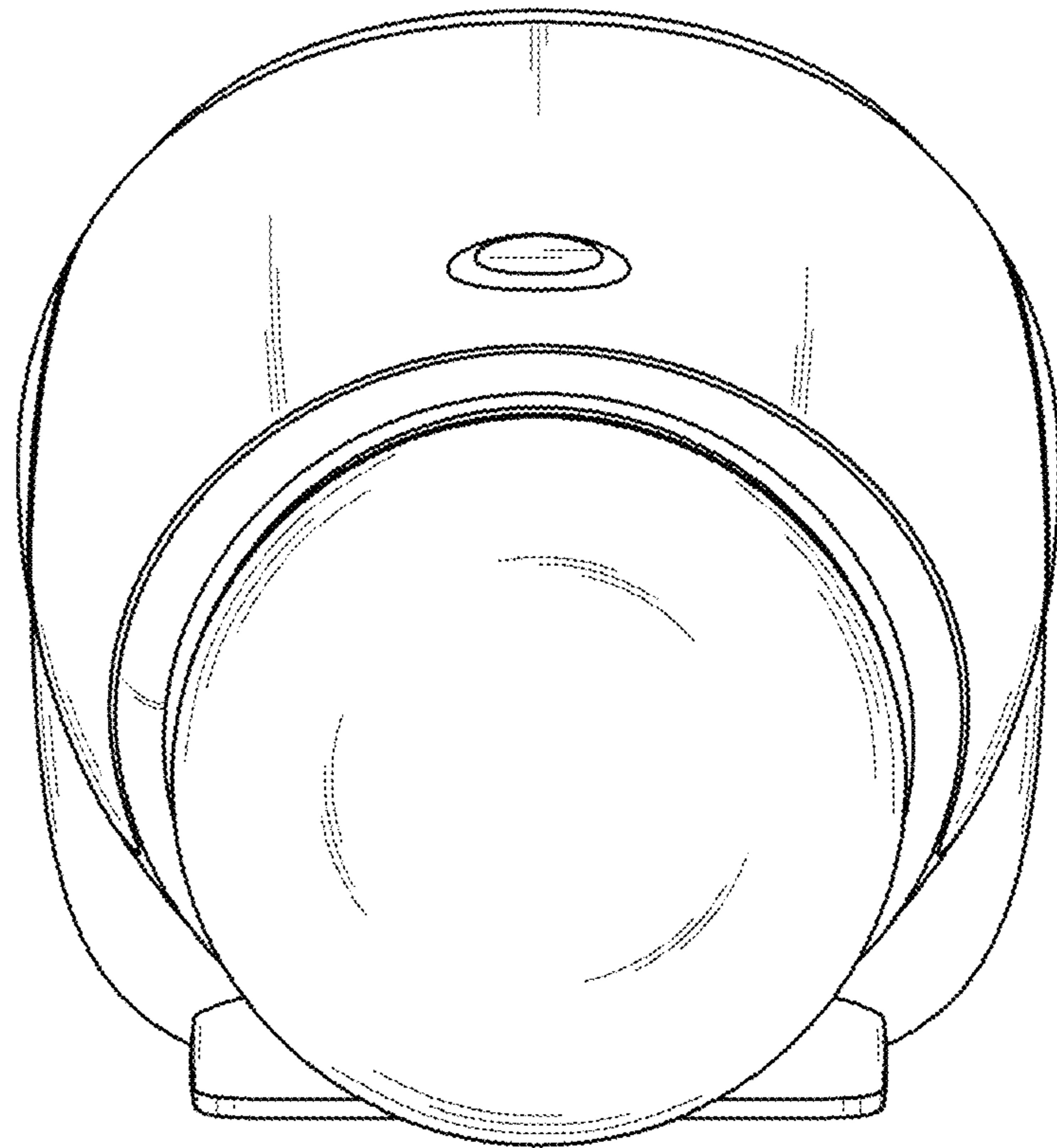

1.28

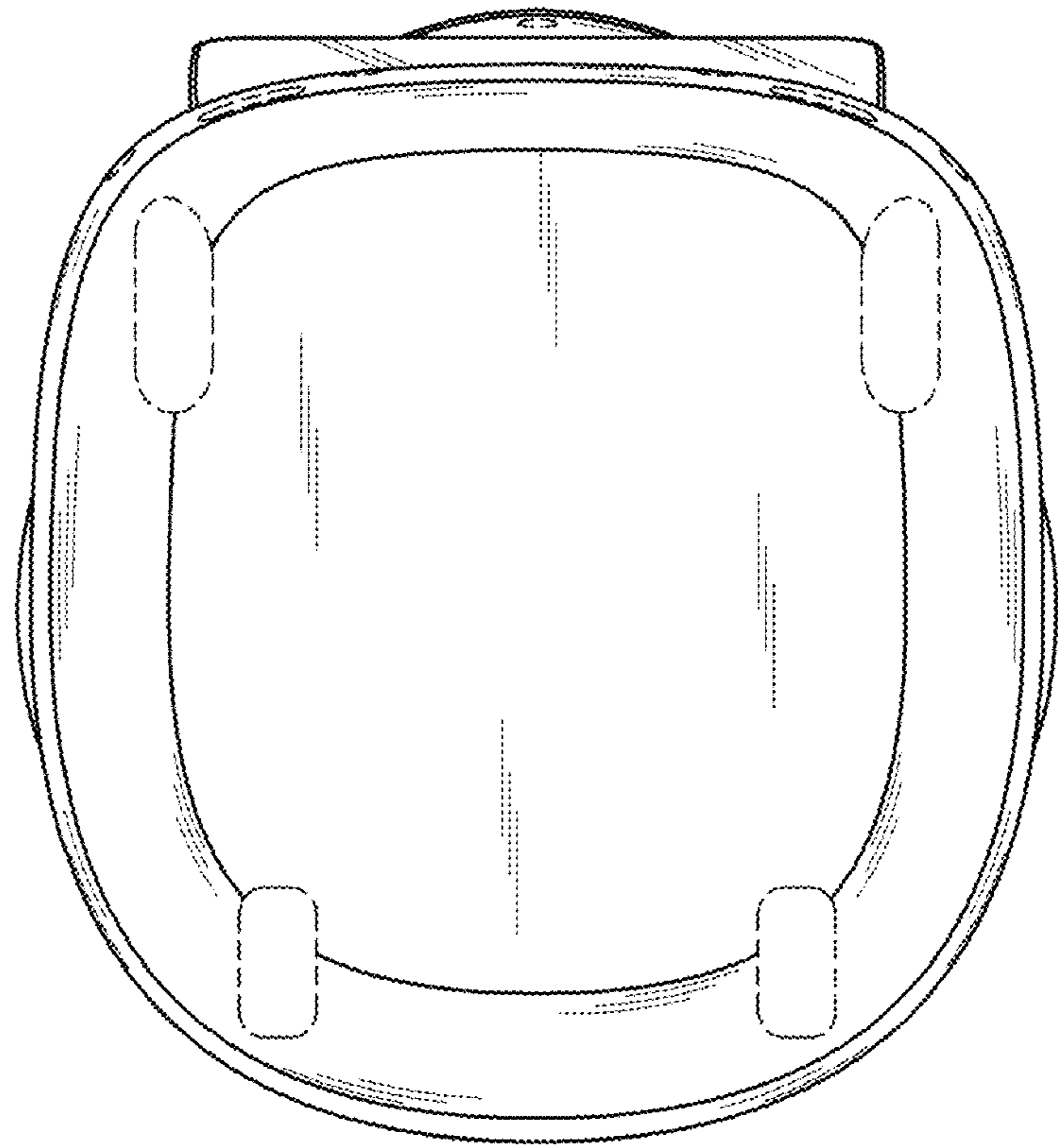

1.29

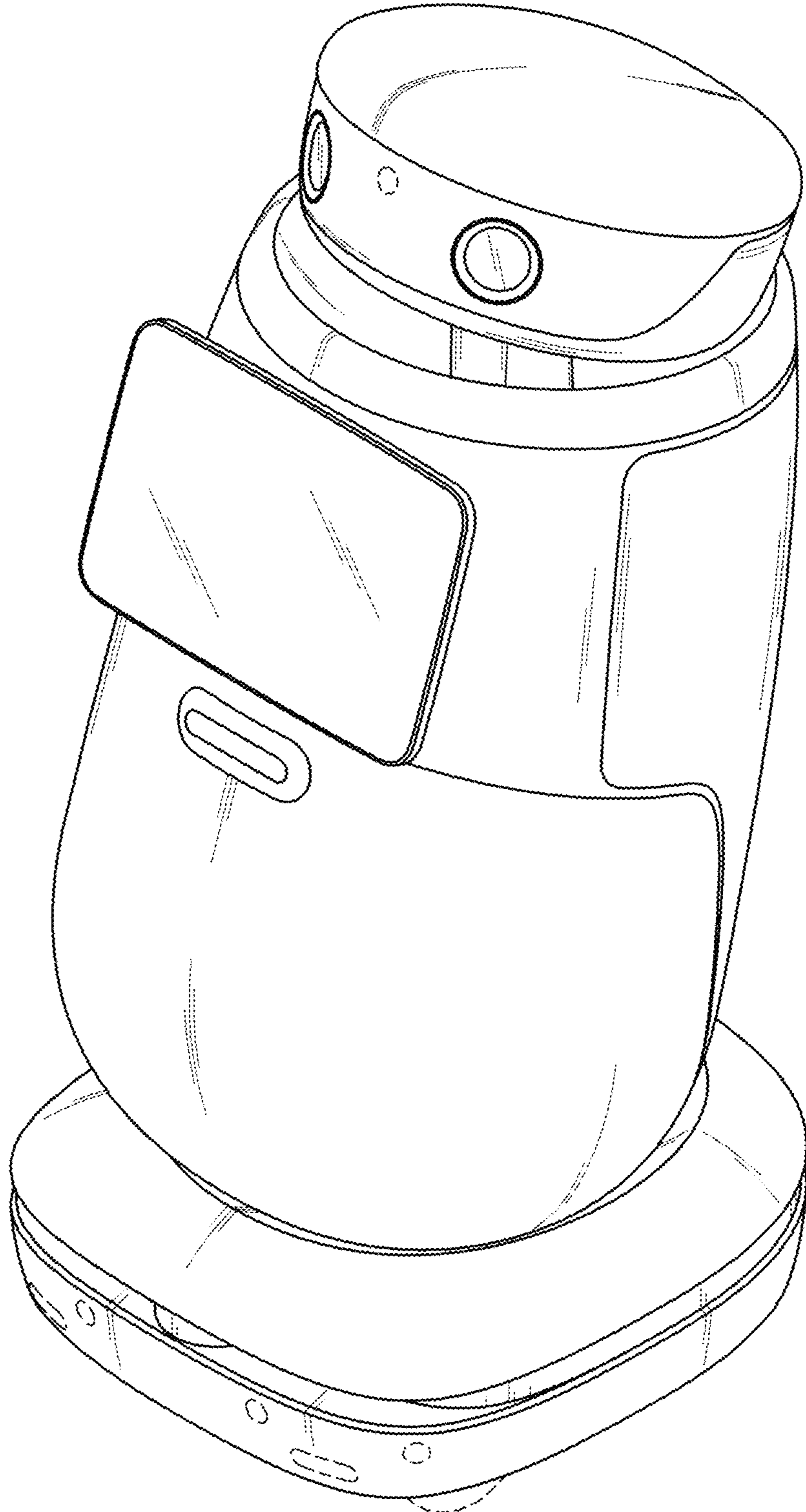

1.30

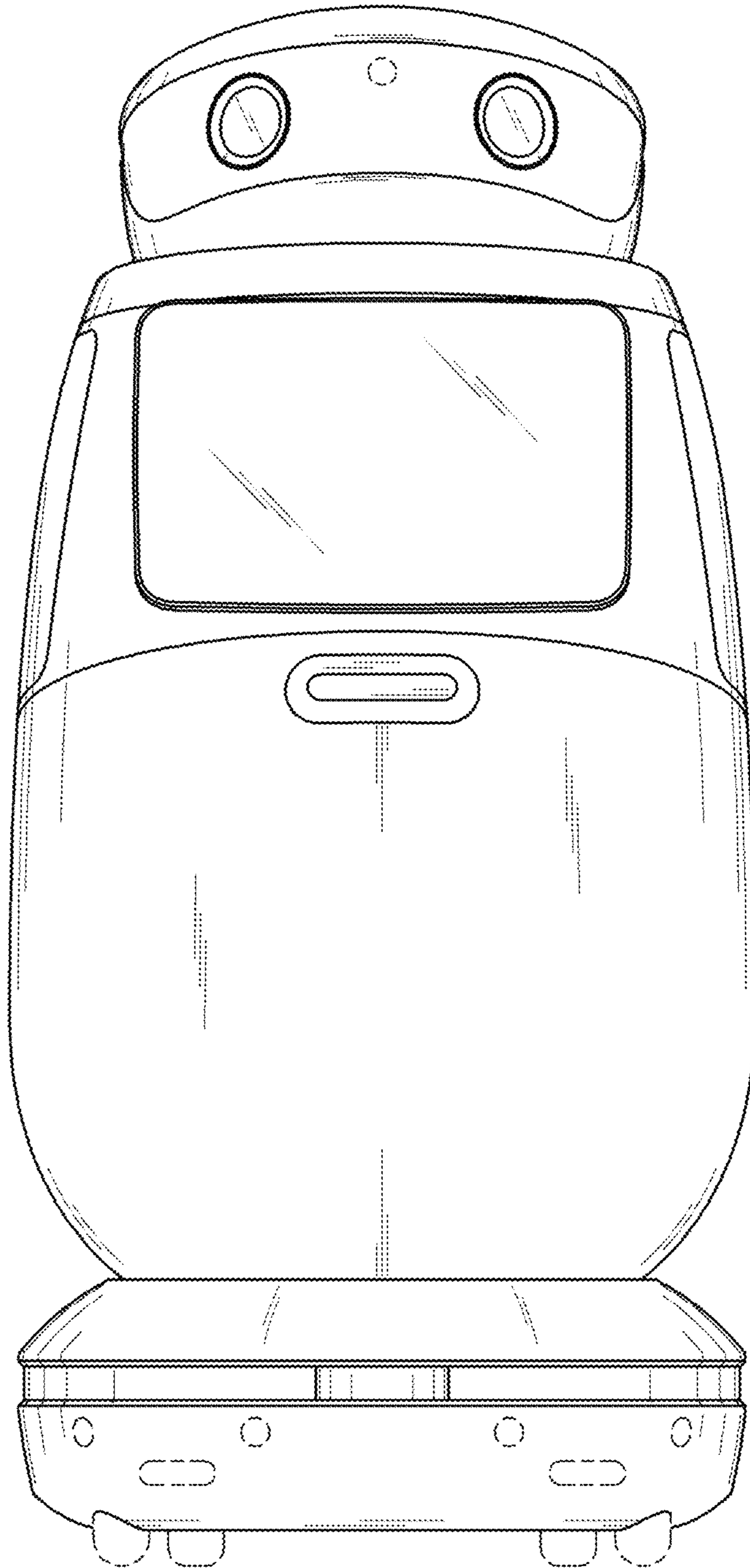

1.31

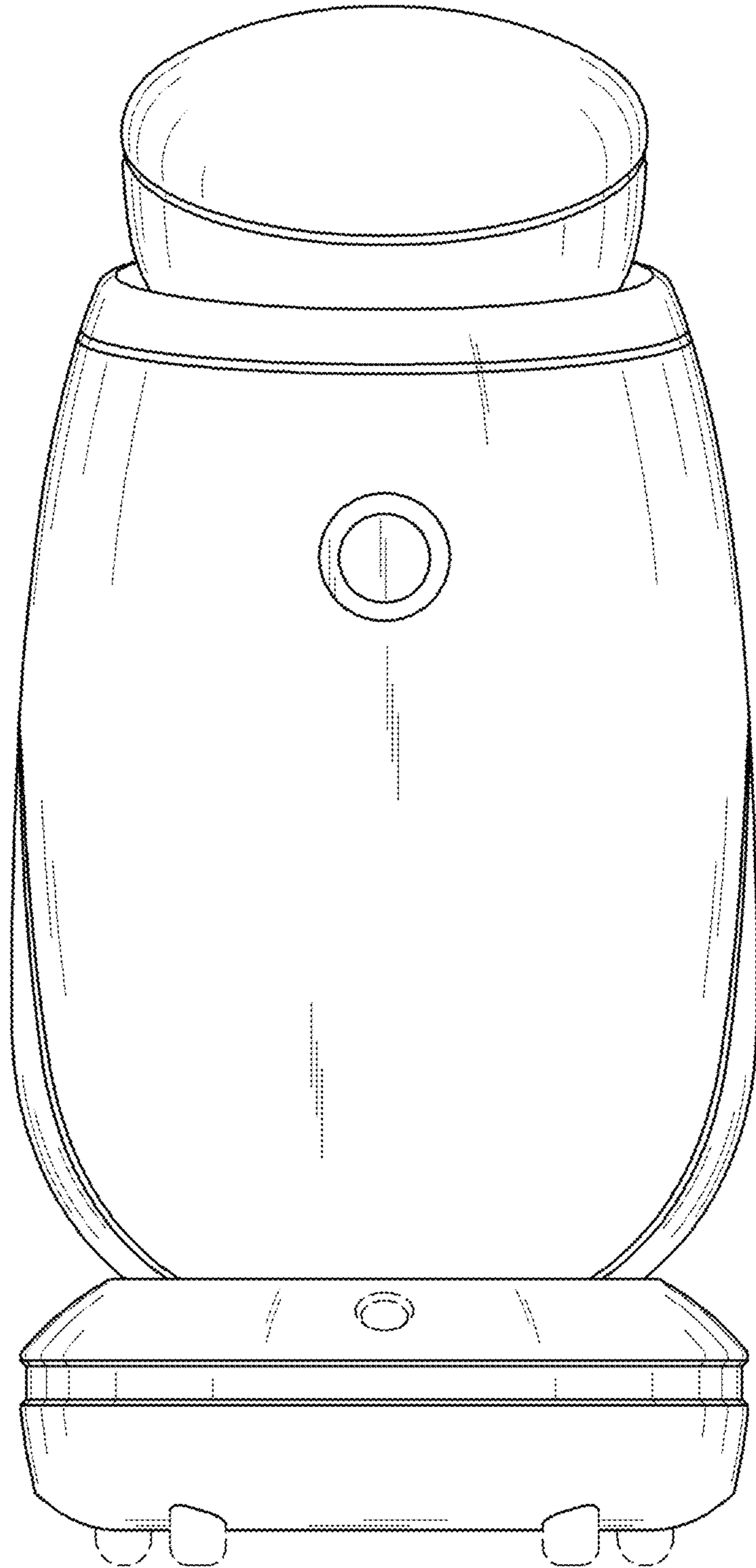

1.32

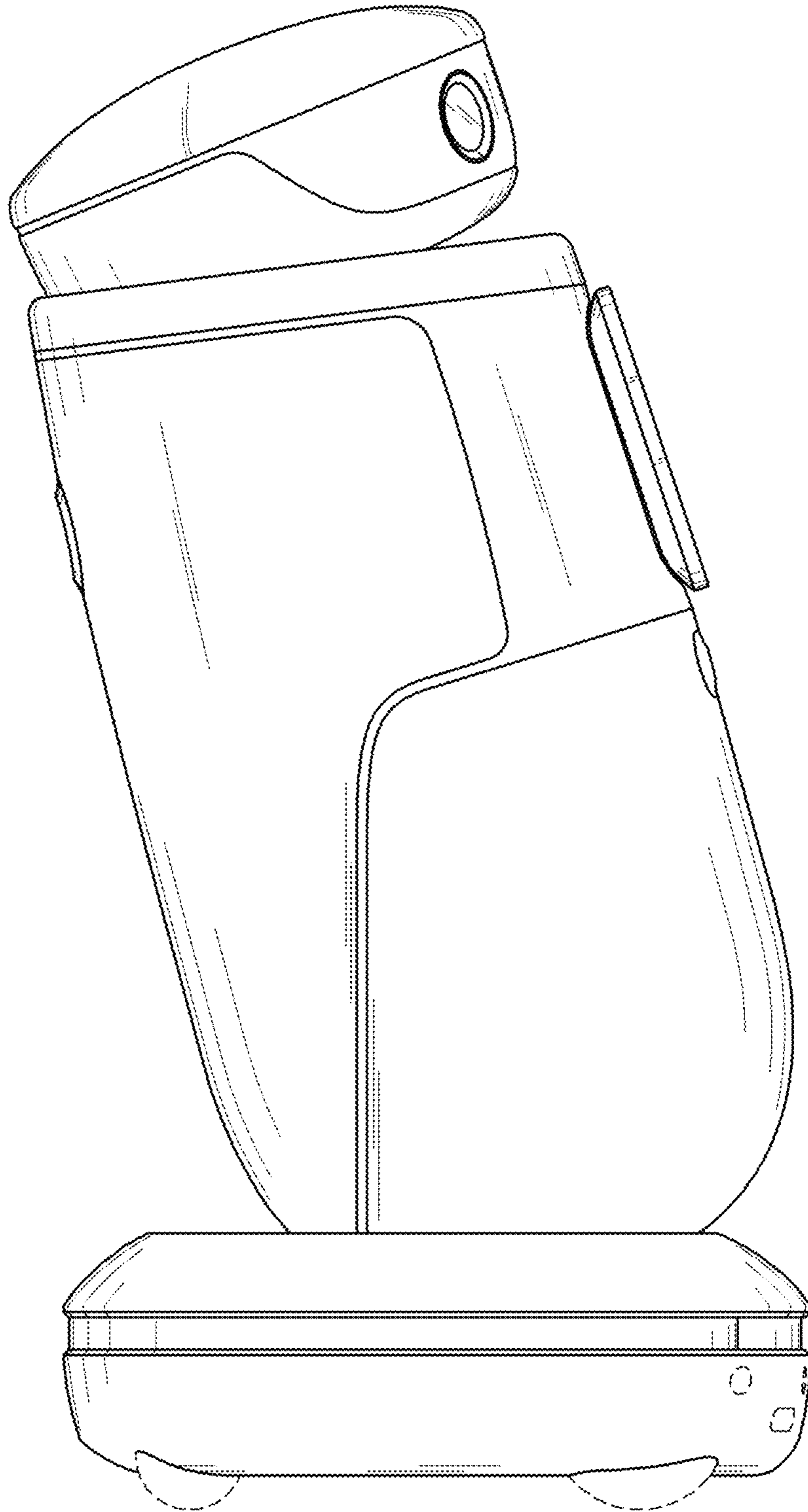

1.33

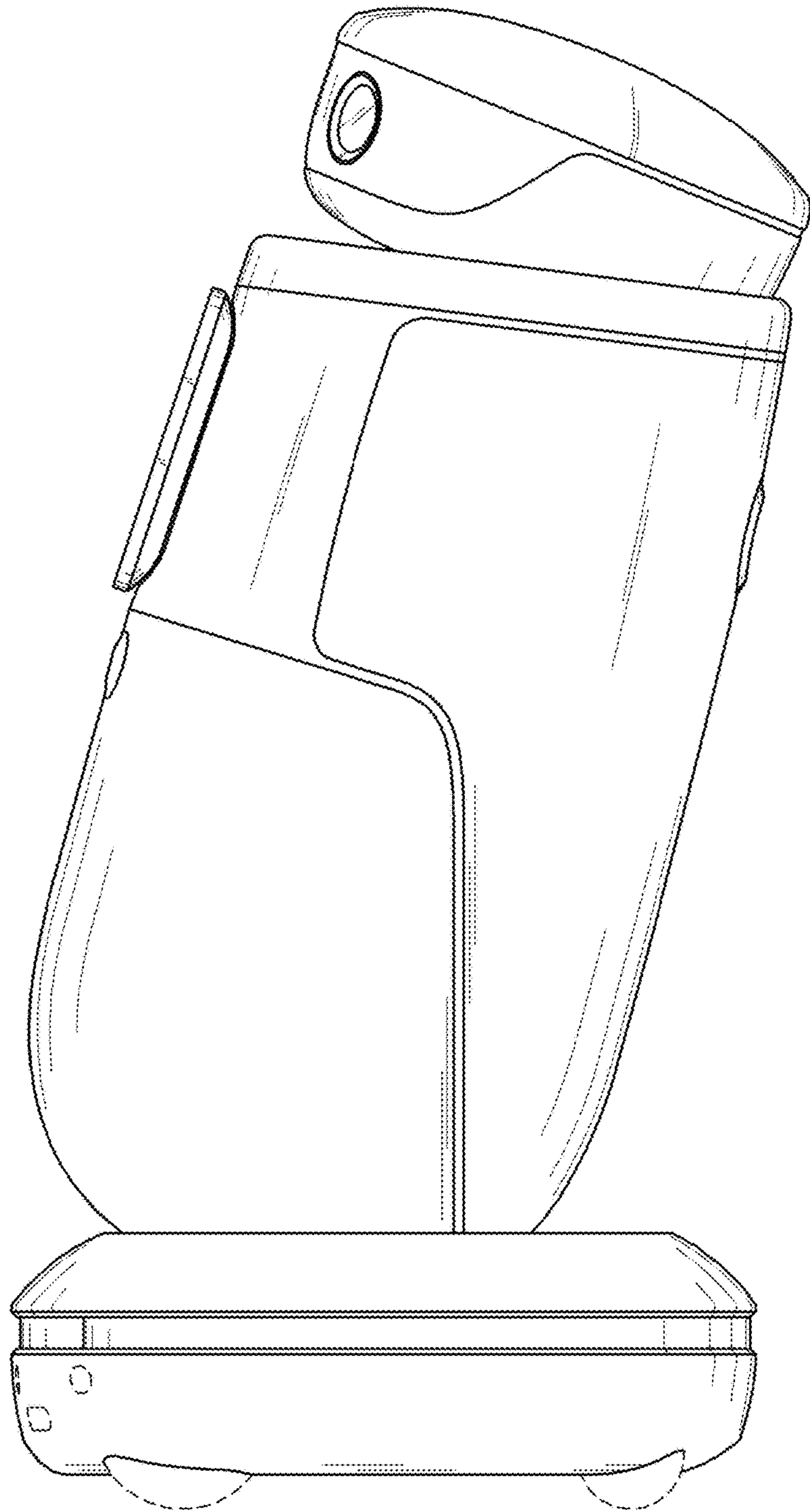

1.34

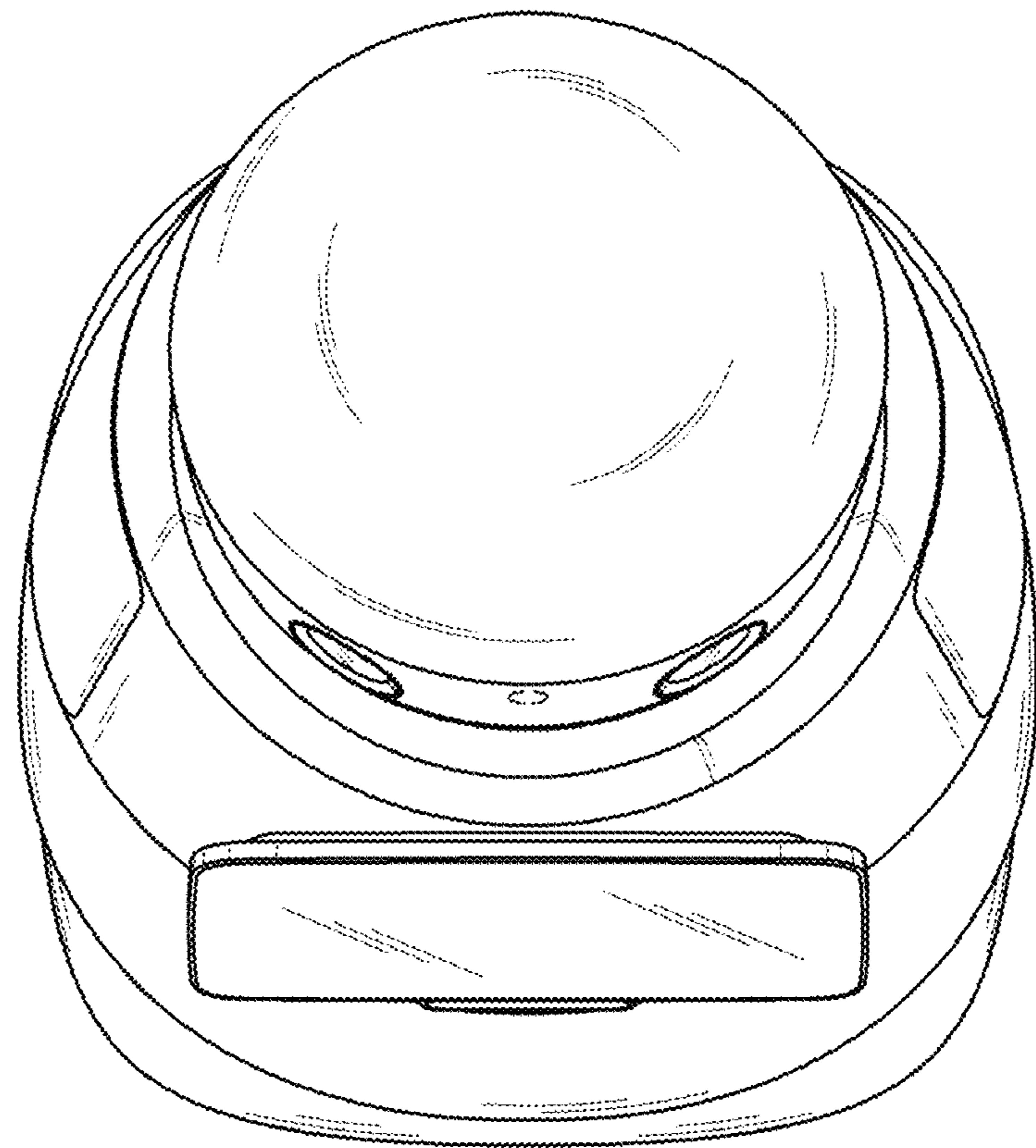

1.35

