



US00D922451S

(12) **United States Design Patent** (10) **Patent No.:** **US D922,451 S**  
**Rajopadhye et al.** (45) **Date of Patent:** **\*\* Jun. 15, 2021**

(54) **PANEL OF A HARVESTER**  
(71) Applicant: **Deere & Company**, Moline, IL (US)  
(72) Inventors: **Dhananjay Rajopadhye**, Pune (IN);  
**Paul M. Richardel**, Polk City, IA (US);  
**Paul J. McCredie**, Bettendorf, IA (US);  
**Shantanu Acharya**, Pune (IN); **Vivek**  
**Vedpathak**, Pune (IN); **Felix Nagelin**,  
Malibu, CA (US); **Tobias Adami**,  
Munich (DE)  
(73) Assignee: **DEERE & COMPANY**, Moline, IL  
(US)  
(\*\*) Term: **15 Years**  
(21) Appl. No.: **29/724,295**  
(22) Filed: **Feb. 13, 2020**

**Related U.S. Application Data**

(63) Continuation of application No. 29/712,598, filed on  
Nov. 8, 2019.

**Foreign Application Priority Data**

May 9, 2019 (EM) ..... 006437083

(51) **LOC (13) Cl.** ..... **15-03**

(52) **U.S. Cl.**  
USPC ..... **D15/33**

(58) **Field of Classification Search**  
USPC ..... D15/10-12, 22-26, 28; 56/14.5-14.7,  
56/16.6, 122-125  
CPC ..... A01B 73/00; A01D 75/00; A01D 41/06;  
A01D 41/1208; A01D 41/00; A01D  
67/00; A01D 45/00; A01D 45/02; A01D  
45/021; A01D 43/081

See application file for complete search history.

(56) **References Cited**

U.S. PATENT DOCUMENTS

4,502,270 A	3/1985	Shupert	
D373,591 S *	9/1996	Von Allworden	D15/26
D639,826 S *	6/2011	Barrelmeyer	D15/26
D643,052 S *	8/2011	Hagele	D15/33
D648,357 S *	11/2011	Hagele	D15/33
D717,345 S *	11/2014	Budde	D15/26
D736,271 S *	8/2015	Jacobsthal	D15/33
D743,450 S *	11/2015	Claeys	D15/33

(Continued)

FOREIGN PATENT DOCUMENTS

CN	302092321 S	9/2012
CN	302220180 S	12/2012

OTHER PUBLICATIONS

Deere & Company, Grain Harvesting Combines and Front End  
Equipment, Brochure, Oct. 2018.

(Continued)

*Primary Examiner* — Mark A Goodwin

(74) *Attorney, Agent, or Firm* — Klintworth & Rozenblat  
IP LLP

(57) **CLAIM**

The ornamental design for a panel of a harvester, as shown  
and described.

**DESCRIPTION**

FIG. 1 is a perspective view of a panel of a harvester  
according to our new design;  
FIG. 2 is a first side elevational view thereof;  
FIG. 3 is a second side elevational view thereof;  
FIG. 4 is a first end elevational view thereof;  
FIG. 5 is a second end elevational view thereof;  
FIG. 6 is a first plan view thereof; and,  
FIG. 7 is a second plan view thereof.  
The dashed lines depict environment subject matter that  
forms no part of the claimed design.

**1 Claim, 5 Drawing Sheets**

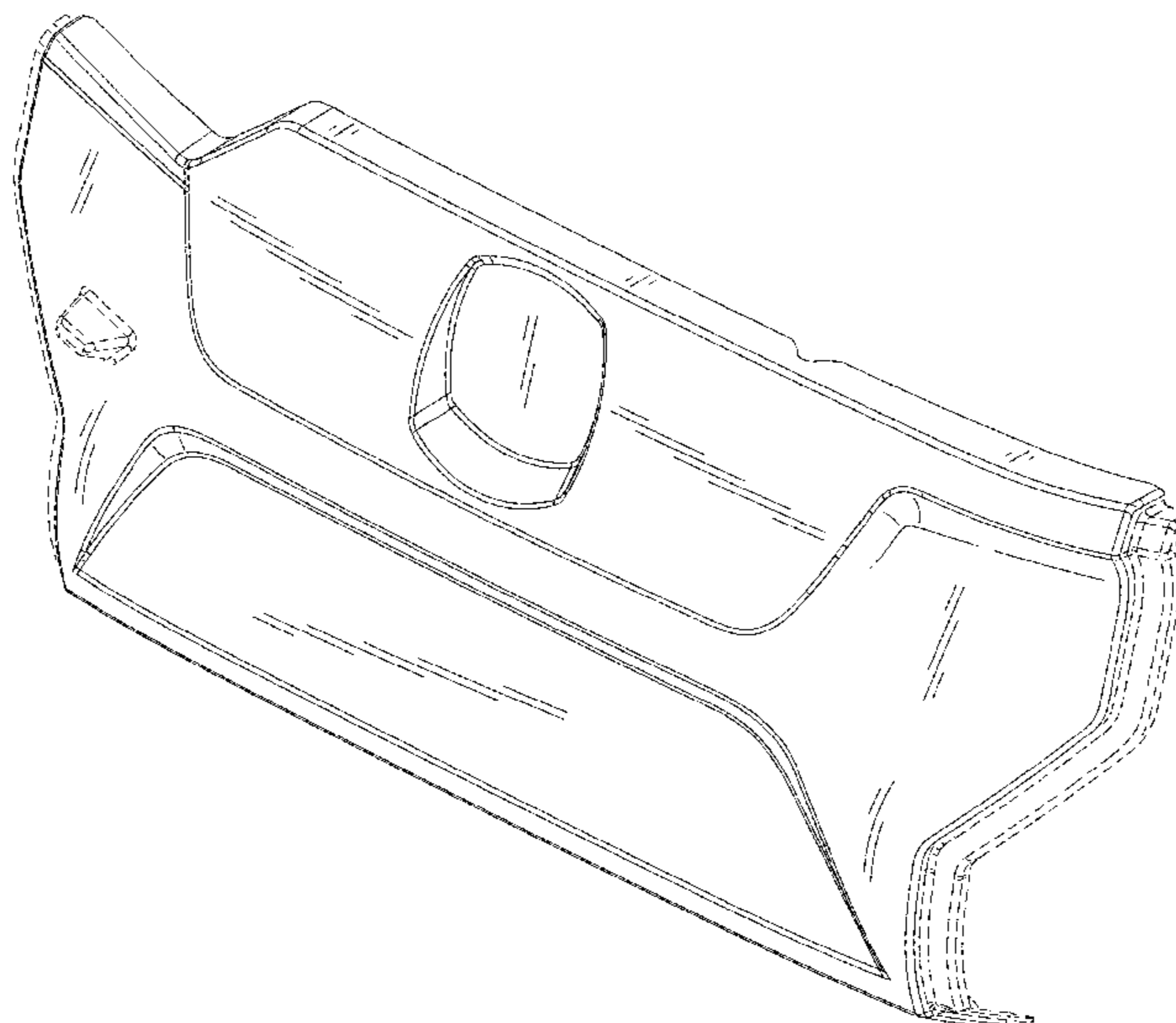

(56)

**References Cited**

## U.S. PATENT DOCUMENTS

D746,342 S \* 12/2015 Jacobsthal ..... D15/33  
D794,086 S \* 8/2017 Thompson ..... D15/26  
D826,994 S \* 8/2018 De Smet ..... D15/26  
D879,843 S \* 3/2020 Gonzales ..... D15/33  
D880,539 S \* 4/2020 Depoorter ..... D15/33  
2017/0086374 A1 3/2017 Engel

## OTHER PUBLICATIONS

Claas of America, Improves Profitability with Increasing Revenue, Google Search, <https://www.serbia.claas.com/news-testimonials/current/claas-news/claas-improves-profitability-with-increasing-revenue-/1904264>, 2019.

Claas of America, photograph of header, 2017.

New Holland, Overview—Corn Heads Leading From The Front, Combines & Headers, <https://agriculture.newholland.com/nar/en-us/equipment/products/combines-and-headers/com-heads>, 2019.

Macdon Industries LTD, D65 Draper Header, Draper Headers for Combine, <https://www.macdon.com/en/products/d65-draper-headers-for-combine/>, 2019.

New Holland, Draper Heads—Overview Combines & Headers New Holland (US) NHAG, <https://agriculture.newholland.com/nar/en-us/equipment/products/combines-and-headers/draper-heads>, 2019.

Case IH, Draper Heads Combine Harvester, Case IH 3100 Series II Draper Heads, <https://www.caseih.com/northamerica/en-us/products/harvesting/draper-heads>, Copyright 2020.

Massey Ferguson, 9250 DynaFlex Draper Header, <http://www.masseyferguson.us/products/combine-harvesting/9250-dynaflex-draper-headers.html#0>, Copyright 2020.

\* cited by examiner

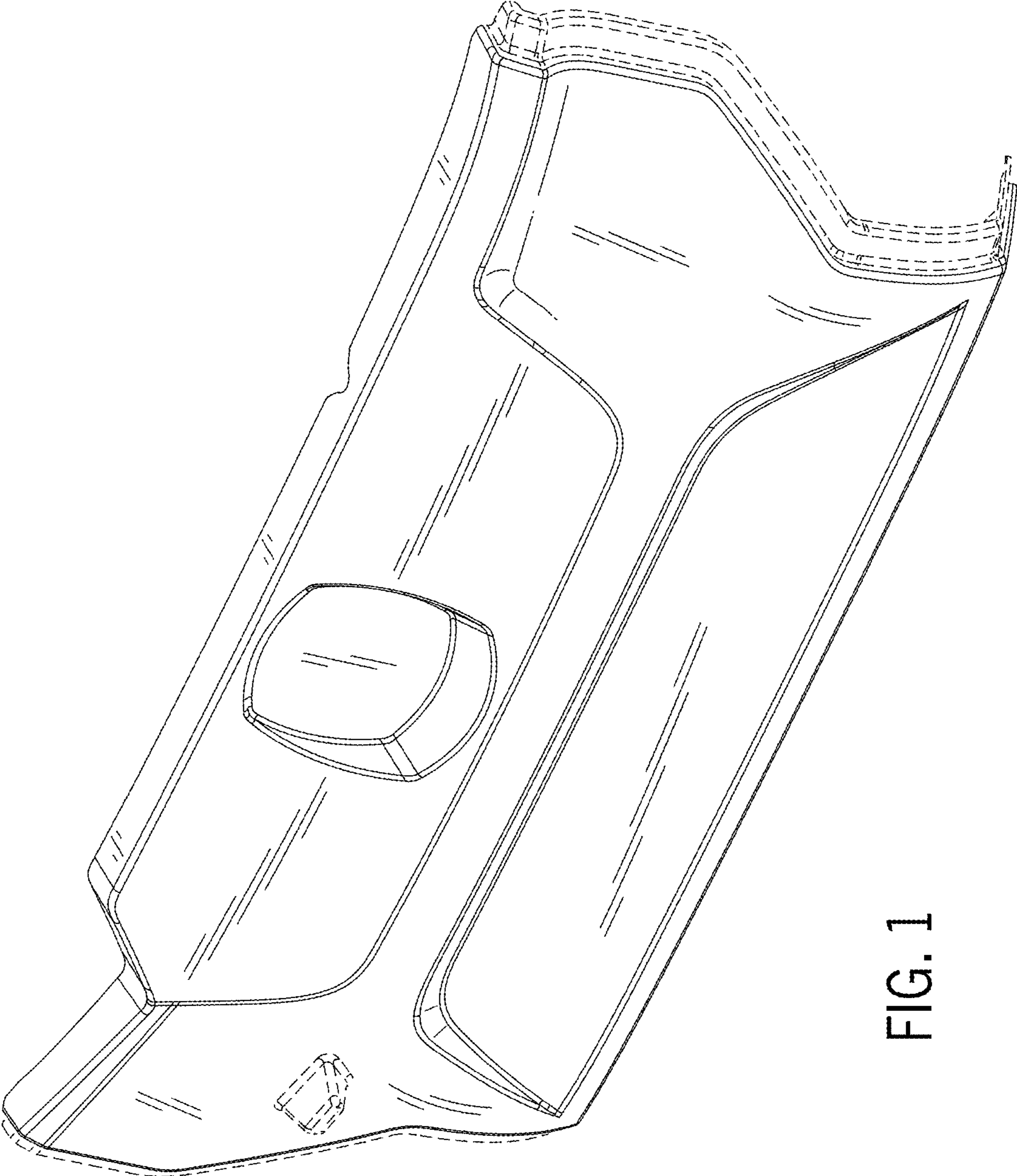

FIG. 1

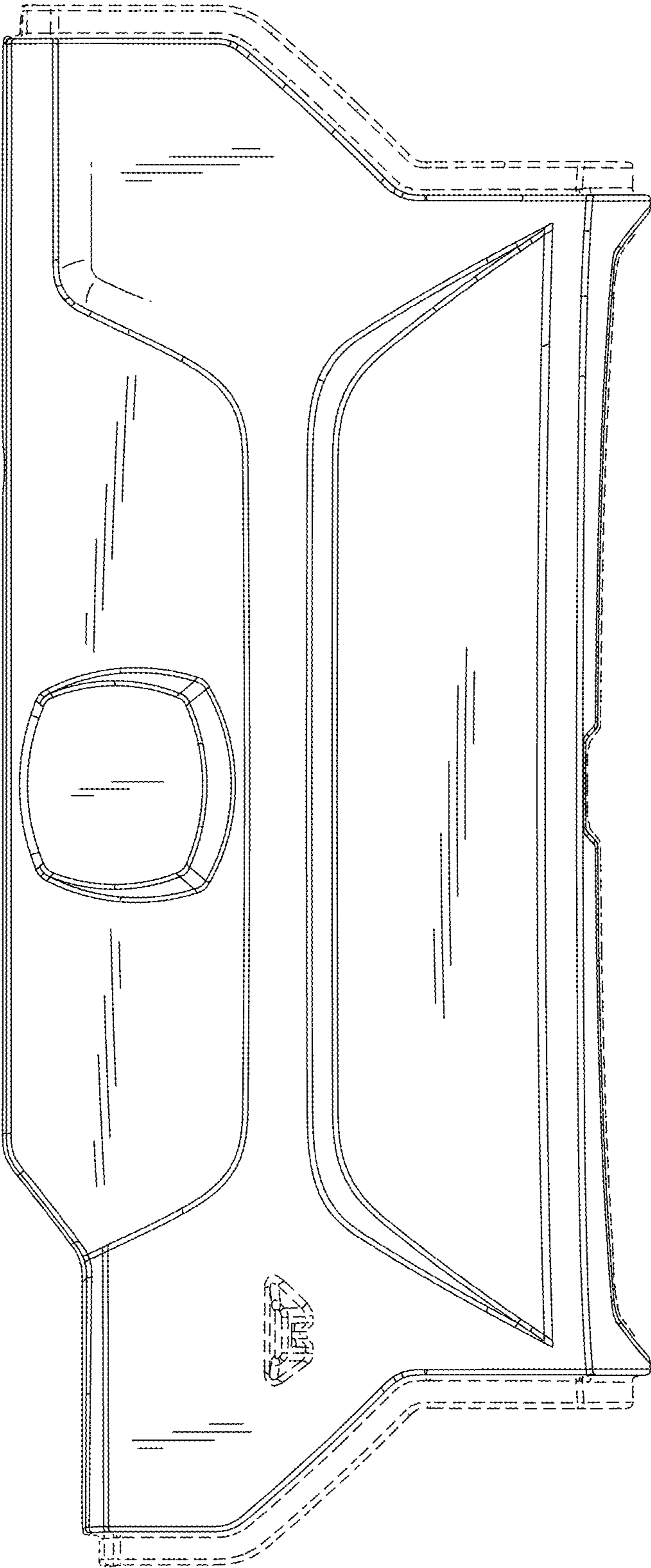

FIG. 2

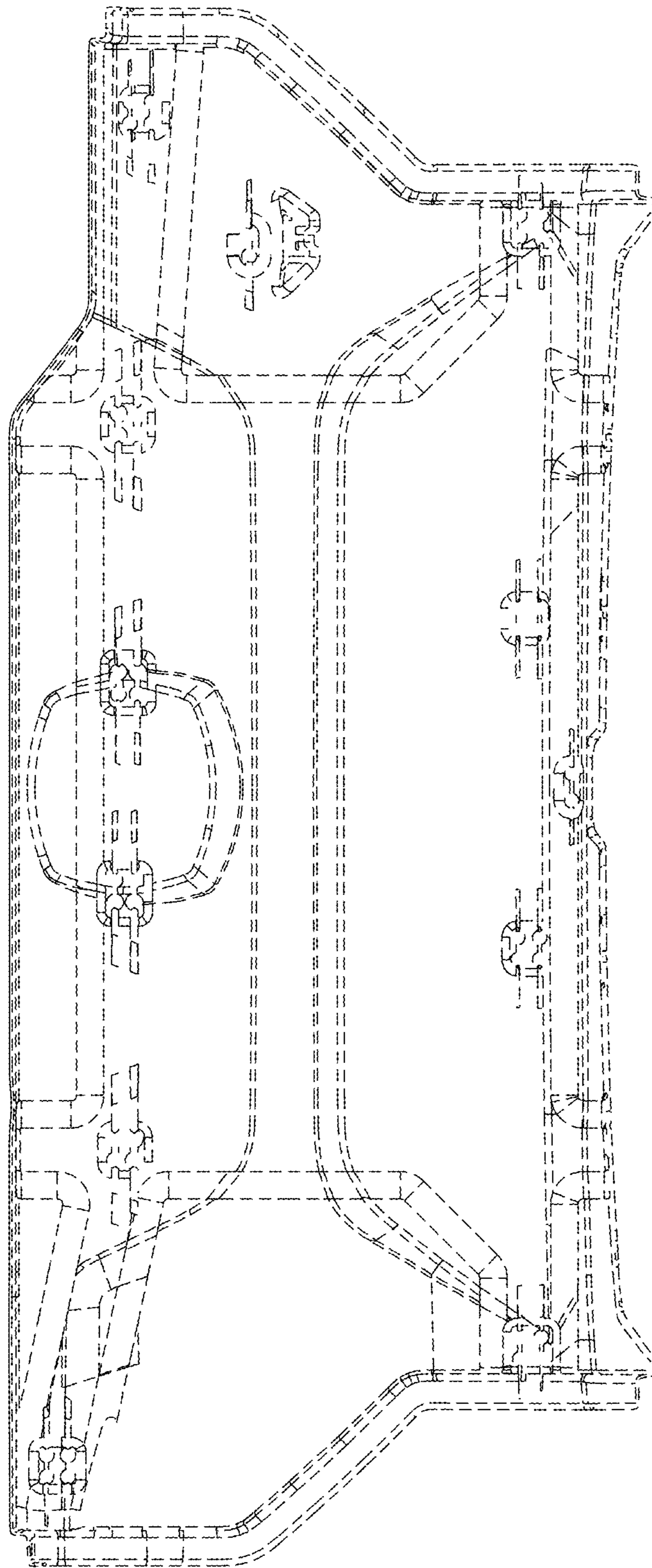

FIG. 3

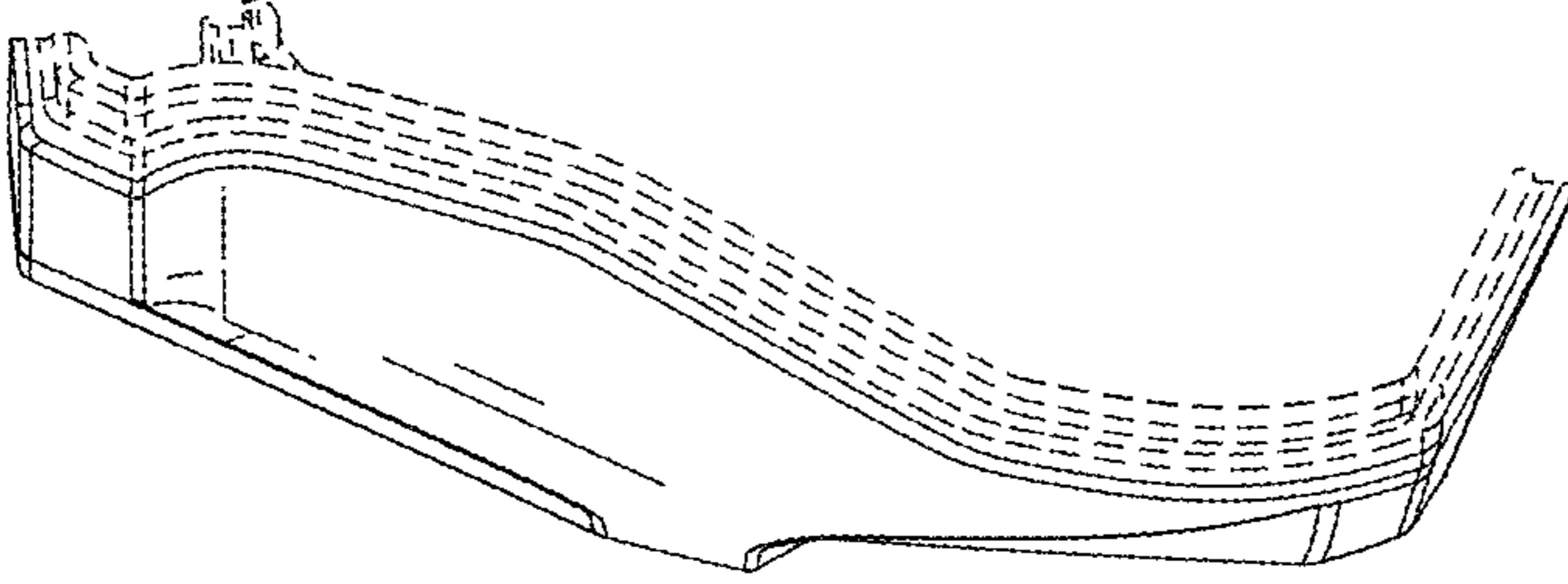

FIG. 5

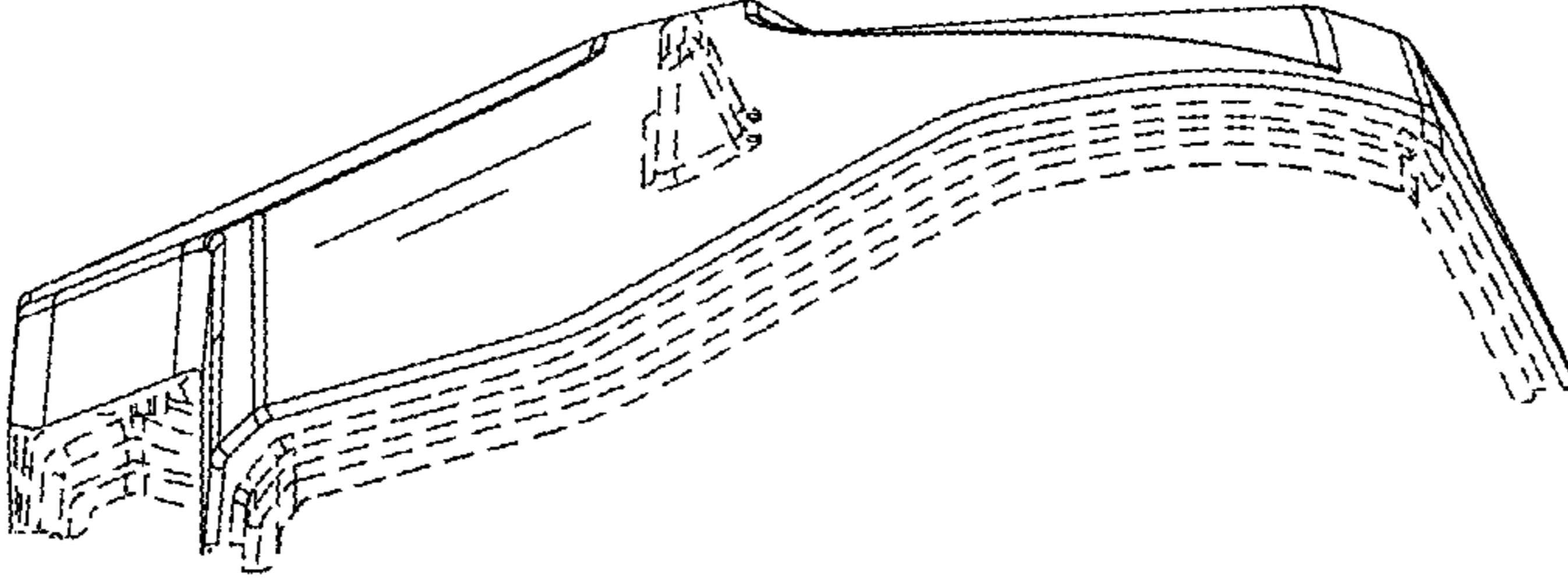

FIG. 4

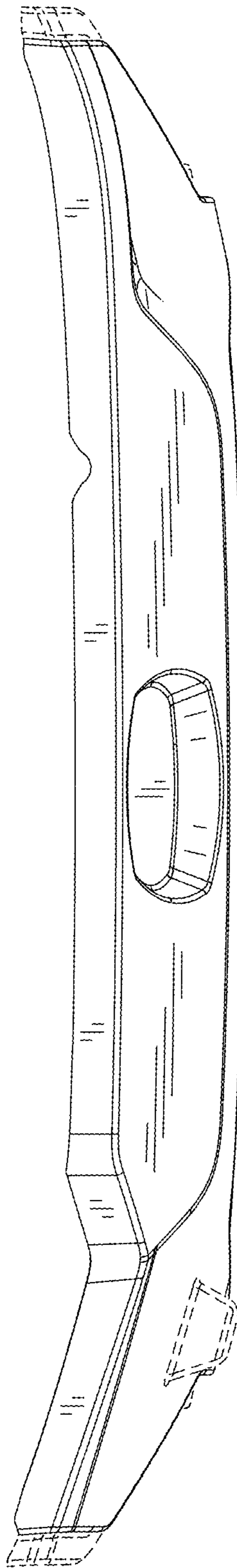

FIG. 6

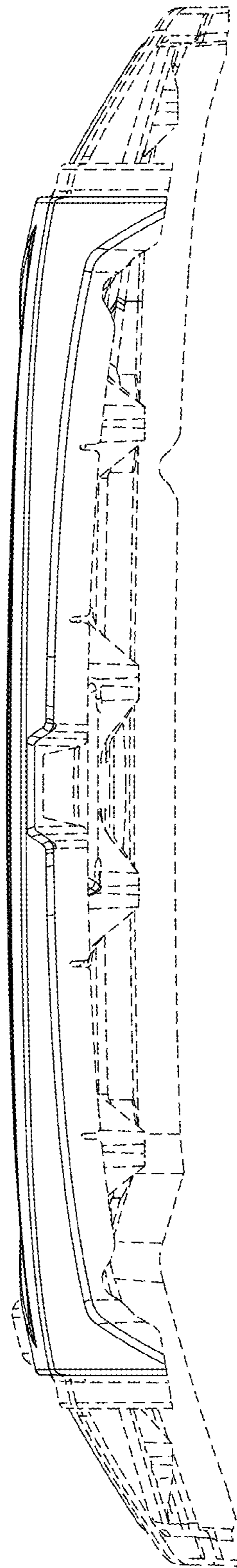

FIG. 7