



US00D922377S

(12) **United States Design Patent** (10) **Patent No.:** **US D922,377 S**  
**Kozlovskaya et al.** (45) **Date of Patent:** **\*\* Jun. 15, 2021**

(54) **SMART WATCH**

(71) Applicant: **Fitbit, Inc.**, San Francisco, CA (US)  
(72) Inventors: **Irina Igorevna Kozlovskaya**, San Francisco, CA (US); **Benjamin Patrick Robert Jean Riot**, San Francisco, CA (US); **Anthony Gerald Kern**, Pleasant Hill, CA (US); **Derek Jenchia Loh**, San Carlos, CA (US); **Bernhard Wildner**, San Francisco, CA (US); **Junyong Park**, San Francisco, CA (US); **Jeffrey Andrew Fisher**, Mountain View, CA (US); **Patrick James Markan**, San Francisco, CA (US)

(73) Assignee: **Fitbit, Inc.**, San Francisco, CA (US)

(\*\*) Term: **15 Years**

(21) Appl. No.: **29/722,312**

(22) Filed: **Jan. 28, 2020**

**Related U.S. Application Data**

(62) Division of application No. 29/635,224, filed on Jan. 29, 2018.

(51) **LOC (13) Cl.** ..... **14-02**

(52) **U.S. Cl.**  
USPC ..... **D14/344**

(58) **Field of Classification Search**  
USPC .. D14/138 R, 144, 341, 344, 358, 388, 218;  
D10/30-39, 70, 98; D11/3, 4, 26, 93-94,  
D11/78.1, 79, 86; D24/167, 169,  
D24/186-187, 164  
CPC .... A41D 1/002; A41D 19/0034; G04G 17/00;  
G04G 17/02; G04G 17/08; G04G 17/083;  
G04G 17/086; G04C 3/00; G04C 3/001;  
G04C 3/002; G04C 3/004; G04C 3/005;  
G04C 3/007; G04C 17/00; G04C 23/02;

(Continued)

(56) **References Cited**

U.S. PATENT DOCUMENTS

D383,073 S 9/1997 Miller  
D545,220 S 6/2007 Leung  
(Continued)

FOREIGN PATENT DOCUMENTS

EM 003027218-0001 3/2016  
WO DM202843 7/2019

OTHER PUBLICATIONS

U.S. Appl. No. 29/706,974, filed Sep. 25, 2019, applicant Fitbit, Inc.  
(Continued)

*Primary Examiner* — Sheryl Lane

*Assistant Examiner* — Calvin E Vansant

(74) *Attorney, Agent, or Firm* — Polson Intellectual Property Law, PC; Margaret Polson

(57) **CLAIM**

The ornamental design for a smart watch, as shown and described.

**DESCRIPTION**

FIG. 1 is a top, right side isometric view of a first embodiment of our new design for a smart watch.  
FIG. 2 is a right side elevation view of FIG. 1.  
FIG. 3 is a left side elevation view of FIG. 1.  
FIG. 4 front side elevation view of FIG. 1.  
FIG. 5 is a back side elevation view of FIG. 1.  
FIG. 6 is a top plan view of FIG. 1.  
FIG. 7 is a bottom plan view of FIG. 1; and,  
FIG. 8 is a bottom, left side isometric view of FIG. 1.  
The broken lines shown in the drawings depict portions of the smart watch that form no part of the claimed design.

**1 Claim, 6 Drawing Sheets**

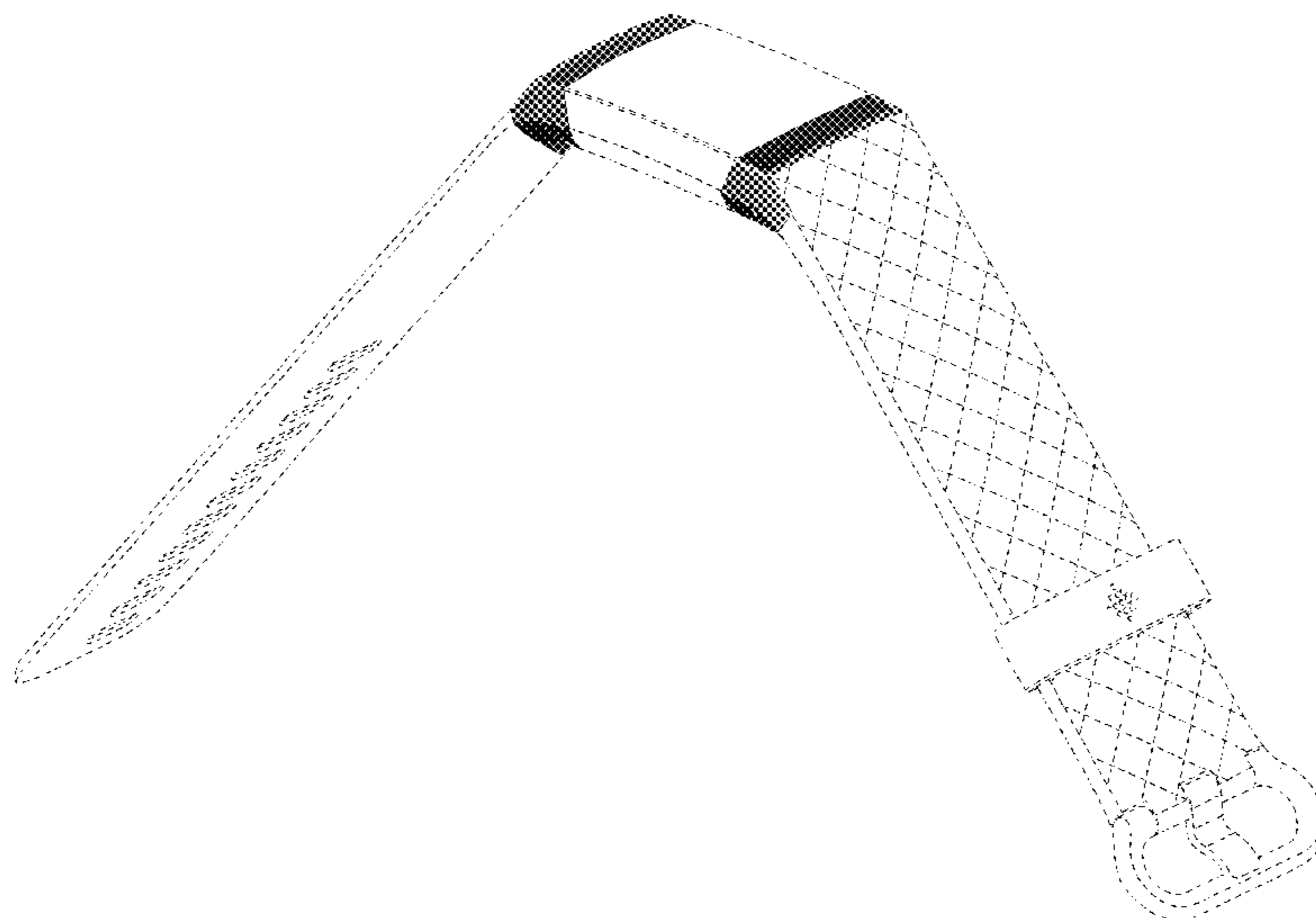



(58) **Field of Classification Search**

CPC ..... G04C 23/04; G04B 3/04; G04B 19/24;  
G04B 19/26; G04B 37/00; G04B  
45/0069; G04B 47/04; G04B 37/0008;  
G04B 37/0058; G04B 37/12; G04B  
37/18; G04B 45/00; G04B 47/00; G04B  
47/042; G04B 47/06; G04B 47/063

See application file for complete search history.

(56) **References Cited**

U.S. PATENT DOCUMENTS

D553,512 S 10/2007 Tang  
8,296,983 B2 10/2012 Padgett et al.  
D714,179 S 9/2014 Park et al.  
D715,167 S 10/2014 Busse  
D715,668 S 10/2014 Roush et al.  
D716,166 S 10/2014 Au Yeung  
D717,956 S 11/2014 Alexander et al.  
D718,647 S 12/2014 Roush et al.  
D720,248 S 12/2014 Law  
D720,249 S 12/2014 Park et al.  
D720,635 S 1/2015 Park et al.  
D724,453 S 3/2015 Ogihara et al.  
D725,510 S 3/2015 Henning  
D729,657 S 5/2015 Behar  
D729,658 S 5/2015 Behar  
D730,211 S 5/2015 Behar  
9,189,023 B2\* 11/2015 Lim ..... G06F 1/163  
D744,357 S 12/2015 Behar et al.  
D744,358 S 12/2015 Behar et al.  
D746,477 S 12/2015 Cha et al.  
D749,002 S 2/2016 Park et al.  
D751,549 S 3/2016 Park et al.  
D752,046 S 3/2016 Jun  
D759,516 S 6/2016 Ling et al.  
D788,608 S 6/2017 Houin et al.  
D796,045 S 8/2017 Henning  
D800,109 S 10/2017 Rouillac et al.  
D800,596 S 10/2017 Ling et al.  
D802,453 S 11/2017 Page et al.  
D806,589 S 1/2018 Le Bihan et al.  
D808,962 S 1/2018 Wu  
D809,144 S 1/2018 Wu  
D809,509 S 2/2018 Bosveld et al.  
D812,497 S 3/2018 Kogen  
D814,643 S 4/2018 Mockler et al.  
D816,080 S 4/2018 Chen et al.  
D816,668 S 5/2018 Wu  
D817,784 S 5/2018 Swenson et al.  
D821,247 S 6/2018 Lean et al.  
D822,836 S 7/2018 Wu  
D826,763 S 8/2018 Chuang  
D827,838 S 9/2018 Lillquist et al.  
D829,330 S 9/2018 Zheng  
D829,713 S 10/2018 Komulainen  
D831,643 S 10/2018 Son et al.  
D831,644 S 10/2018 Wu  
D831,645 S 10/2018 Wu  
10,111,504 B2 10/2018 Hundt et al.  
D833,412 S 11/2018 Guan et al.  
D833,625 S 11/2018 Guan et al.  
10,136,543 B1\* 11/2018 Nadkarni ..... G06F 1/1698  
D835,533 S 12/2018 Zheng  
D838,194 S 1/2019 Mays  
10,168,736 B2\* 1/2019 Lee ..... G04B 37/1486  
D840,042 S 2/2019 Yan  
D840,043 S 2/2019 Li et al.  
D841,171 S 2/2019 Li et al.  
D846,747 S 4/2019 Lillquist et al.  
D848,875 S 5/2019 Wildner et al.  
D851,641 S 6/2019 Zhang  
D857,011 S \* 8/2019 Kang ..... D14/344  
D858,516 S \* 9/2019 Kang ..... D14/344  
D858,517 S \* 9/2019 Kern ..... D14/344  
D858,518 S \* 9/2019 Riot ..... D14/344  
D860,989 S 9/2019 Choplin et al.

D861,677 S 10/2019 Wu  
D861,678 S 10/2019 Kern et al.  
D861,679 S \* 10/2019 Riot ..... D14/344  
D862,277 S \* 10/2019 Ling ..... D11/3  
D863,296 S \* 10/2019 Kern ..... D14/344  
D864,956 S \* 10/2019 Kern ..... D14/344  
D865,759 S 11/2019 Haranaka et al.  
D869,982 S 12/2019 Paschke et al.  
D875,728 S 2/2020 Wu  
D878,364 S \* 3/2020 Kern ..... D14/344  
2015/0342529 A1 12/2015 Gassoway et al.  
2016/0223992 A1\* 8/2016 Seo ..... G04G 17/02  
2017/0065224 A1 3/2017 Rahko et al.  
2018/0132738 A1 5/2018 Choi et al.

OTHER PUBLICATIONS

U.S. Appl. No. 29/712,115, filed Nov. 5, 2019, applicant Fitbit, Inc.  
U.S. Appl. No. 29/710,723, filed Oct. 25, 2019, applicant Fitbit, Inc.  
U.S. Appl. No. 29/635,224, filed Jan. 29, 2018, applicant Fitbit, Inc.  
U.S. Appl. No. 29/721,845, filed Jan. 23, 2020, applicant Fitbit, Inc.  
U.S. Appl. No. 29/721,870, filed Jan. 23, 2020, applicant Fitbit, Inc.  
U.S. Appl. No. 29/722,312, filed Jan. 28, 2020, applicant Fitbit, Inc.  
U.S. Appl. No. 29/722,314, filed Jan. 28, 2020, applicant Fitbit, Inc.  
U.S. Appl. No. 29/725,314, filed Feb. 24, 2020, applicant Fitbit, Inc.  
U.S. Appl. No. 29/645,397, filed Apr. 25, 2018, applicant Fitbit, Inc.  
U.S. Appl. No. 29/708,648, filed Oct. 8, 2019, applicant Fitbit, Inc.  
U.S. Appl. No. 29/707,456, filed Sep. 27, 2019, applicant Fitbit, Inc.  
U.S. Appl. No. 29/656,638, filed Jul. 13, 2018, applicant Fitbit, Inc.  
U.S. Appl. No. 29/671,144, filed Nov. 24, 2018, applicant Fitbit, Inc.  
U.S. Appl. No. 29/669,190, filed Nov. 6, 2018, applicant Fitbit, Inc.  
U.S. Appl. No. 29/702,572, filed Aug. 20, 2019, applicant Fitbit, Inc.  
U.S. Appl. No. 29/702,946, filed Aug. 22, 2019, applicant Fitbit, Inc.  
U.S. Appl. No. 29/702,703, filed Aug. 21, 2019, applicant Fitbit, Inc.  
U.S. Appl. No. 29/688,946, filed Apr. 25, 2019, applicant Fitbit, Inc.  
U.S. Appl. No. 29/702,397, filed Aug. 19, 2019, applicant Fitbit, Inc.  
U.S. Appl. No. 29/705,182, filed Sep. 10, 2019, applicant Fitbit, Inc.  
U.S. Appl. No. 29/711,032, filed Oct. 28, 2019, applicant Fitbit, Inc.  
U.S. Appl. No. 29/725,309, filed Feb. 24, 2020, applicant Fitbit, Inc.  
U.S. Appl. No. 29/725,313, filed Feb. 24, 2020, applicant Fitbit, Inc.  
“New Fitbit Versa on the way with built-in Amazon Alexa?” Source: androidauthority.com (<https://www.androidauthority.com/fitbit-versa-2-amazon-alexa-1014860/>). Website accessed Mar. 30, 2020.  
Connect By Timex Active Smartwatch with Heart Rate, Notifications and Activity Tracking, available at Amazon.com (<https://www.amazon.com/iConnect-Timex-TW5M34400-Active-Smartwatch/dp/B07XZRQBGV>). Website accessed Mar. 30, 2020.  
Alfawise H19 RFID Sports Smartwatch Fitness Tracker—Black, available at gearbest.com ([https://www.gearbest.com/smartwatches/pp\\_009207049039.html?wid=1433363](https://www.gearbest.com/smartwatches/pp_009207049039.html?wid=1433363)). Website accessed Mar. 30, 2020.  
Ergofinity™ Bluetooth Smart Watch available at ergofinity.com (<https://ergofinity.com/products/bluetooth-smart-watch-ios-android>). Website accessed Mar. 30, 2020.  
Amazfit BIP Lite 3ATM Smart Watch (Blue) available at amazon.in ([https://www.amazon.in/Amazfit-Lite-3ATM-Smart-Watch/dp/B07WQWDYJ7/ref=asc\\_df\\_B07WQWDYJ7/?tag=googleshopdes-21&linkCode=df0&hvadid=397082878775&hvpos=&hvnetw=g&hvrand=13400080515884943460&hvpone=&hvptwo=&hvqmt=&hvdev=c&hvdvcmdl=&hvlocint=&hvlocphy=1007765&hvtargid=pla-819594895182&pvc=1&ext\\_vmc=hi](https://www.amazon.in/Amazfit-Lite-3ATM-Smart-Watch/dp/B07WQWDYJ7/ref=asc_df_B07WQWDYJ7/?tag=googleshopdes-21&linkCode=df0&hvadid=397082878775&hvpos=&hvnetw=g&hvrand=13400080515884943460&hvpone=&hvptwo=&hvqmt=&hvdev=c&hvdvcmdl=&hvlocint=&hvlocphy=1007765&hvtargid=pla-819594895182&pvc=1&ext_vmc=hi)). Website accessed Mar. 30, 2020.  
Silicone Sport wristband Watch band For Samsung Gear Fit 2 SM-R360 smart watch For Samsung Gear Fit 2 watchbands Accessories, available at Ali Express <https://www.aliexpress.com/item/32971838973.html>.  
Watch Repair Tool Stainless Connector Watch Accessory For Samsung Gear Fit 2 Pro Replace Tools Connect Device For Gear Fit 2,



(56)

## References Cited

## OTHER PUBLICATIONS

available at Ali Express ([https://www.aliexpress.com/item/32953625569.html?aff\\_platform=dynamic-window&sk=AMnm2vF&aff\\_trace\\_key=fb0d3327f41349d3b416c0af3d374d93-1584617558441-08967-AMnm2vF&terminal\\_id=830dca5b7b89422b94fafe85b01e7764&aff\\_request\\_id=fb0d3327f41349d3b416c0af3d374d93-1584617558441-08967-AMnm2vF](https://www.aliexpress.com/item/32953625569.html?aff_platform=dynamic-window&sk=AMnm2vF&aff_trace_key=fb0d3327f41349d3b416c0af3d374d93-1584617558441-08967-AMnm2vF&terminal_id=830dca5b7b89422b94fafe85b01e7764&aff_request_id=fb0d3327f41349d3b416c0af3d374d93-1584617558441-08967-AMnm2vF)). Website accessed Mar. 30, 2020.

U.S. Appl. No. 29/712,571, filed Nov. 8, 2019, applicant Fitbit, Inc.

U.S. Appl. No. 29/716,025, filed Dec. 5, 2019, applicant Fitbit, Inc.

U.S. Appl. No. 29/728,323, filed Mar. 17, 2020, applicant Fitbit, Inc.

U.S. Appl. No. 29/728,402, filed Mar. 18, 2020, applicant Fitbit, Inc.

U.S. Appl. No. 29/728,447, filed Mar. 18, 2020, applicant Fitbit, Inc.

U.S. Appl. No. 29/705,460, filed Sep. 12, 2019, applicant Fitbit, Inc.

U.S. Appl. No. 29/593,261, filed Feb. 7, 2017, applicant Fitbit, Inc.

POY Compatible Bands Replacement for Fitbit Alta, Fitbit Alta HR sold on Amazon. Website accessed Mar. 1, 2019.

Monster Fitness Multicolor Replacement Bands for Fitbit Flex sold on Amazon. Website accessed Mar. 1, 2019.

GK Fitbit Alta Bands—replacement sport strap bands for Fitbit Alta for sale at Walmart ([www.walmart.com](http://www.walmart.com)). Website accessed Nov. 7, 2018.

Suunto Core watchband on Instagram. Accessed Feb. 7, 2017.

Suppa G-Shock Strap Adapters, online at least as early as Dec. 13, 2013. Accessed Feb. 7, 2017.

Monserat de Lucca Measuring Tape Bracelet for sale at Shopbop ([www.shopbop.com](http://www.shopbop.com)). Website accessed Nov. 11, 2018.

Marc by Marc Jacobs Engraved Turlock Leather Bangle Bracelet for sale at Shopbop ([www.shopbop.com](http://www.shopbop.com)). Website accessed Nov. 11, 2018.

ACBEE Replacement watch band with buckle for Fitbit Alta for sale at [www.amazon.com](http://www.amazon.com), Website accessed Nov. 7, 2018.

Perfit rubber watch band with double prong buckle and spring bars for sale at [www.amazon.com](http://www.amazon.com). Website accessed Nov. 7, 2018.

Waterproof diving silicone rubber strap with clasp for sale at [www.aliexpress.com](http://www.aliexpress.com) (Alibaba Group). Website accessed Nov. 7, 2018.

Damusy Fitness Tracker Smart Band for sale at [www.activityandfitness trackers.com](http://www.activityandfitness trackers.com). Website accessed Nov. 10, 2018.

Volemer F09HR Smart Band Fitness Tracker for sale at [www.epaky.com](http://www.epaky.com). Website accessed Nov. 10, 2018.

“First Look: Fitbit announces new Fitbit Alta activity tracker”, published Feb. 3, 2016 on DC Rainmaker ([www.dcrainmaker.com](http://www.dcrainmaker.com)). Website accessed Nov. 10, 2018.

Fitbit Alta—for sale by Fitbit (<https://www.fitbit.com/alta>). Website accessed Mar. 27, 2017.

Fitbit Alta review published Mar. 25, 2016 on C|Net ([www.cnet.com](http://www.cnet.com)). Website accessed Nov. 10, 2018.

Fitbit Charge 2 Heart Rate and Fitness Wristband for sale at [www.amazon.co.uk](http://www.amazon.co.uk). Website accessed Feb. 7, 2018.

Fitbit Flex Wireless Activity and Sleep Wristband for sale at [www.amazon.com](http://www.amazon.com). Listed at least as early as Apr. 16, 2013.

Fitbit Ionic Accessory Band for sale at Nordstrom (<https://shop.nordstrom.com>). Website accessed Nov. 7, 2018.

Fitbit Alta HR Bands for sale at The Fitness Equipment Shop ([www.thefitness equipmentshop.com](http://www.thefitness equipmentshop.com)). Website accessed Nov. 17, 2018.

Luminox Replacement Rubber Watch Band Strap for sale at Walmart ([www.walmart.com](http://www.walmart.com)). Website accessed Nov. 7, 2018.

“MPOW DS-D6 Fitness Band Review” published Jan. 13, 2018 on ZeroAir ([www.zeroair.wordpress.com](http://www.zeroair.wordpress.com)). Website accessed Nov. 10, 2018.

“Fitbit Product Teardown” on Pinterest, pinned from [www.ifixit.com](http://www.ifixit.com). Website accessed Feb. 27, 2017.

Pro Elite Medicine Ball by Power Systems ([www.power-systems.com](http://www.power-systems.com)). Website accessed Feb. 27, 2018.

Replacement metal watch band Connector for Fitbit Alta/Fitbit Alta HR for sale at Banggood ([www.banggood.com](http://www.banggood.com)). Website accessed Nov. 10, 2018.

Citrine by the Stones Sol Forearm Band for sale at Shopbop ([www.shopbop.com](http://www.shopbop.com)). Website accessed Nov. 11, 2018.

Gorjana Mia Wrap Cuff for sale at Shopbop ([www.shopbop.com](http://www.shopbop.com)). Website accessed Nov. 11, 2018.

Fintie for Gear S2 Watch Band Stainless Steel Metal Replacement Strap, for sale at [www.amazon.com](http://www.amazon.com). Website accessed Apr. 24, 2019.

Fitbit Inspire HR review: One size, many styles, fit all, posted May 24, 2019, [retrieved Jun. 5, 2019]. Retrieved from Internet, <URL: <https://www.macworld.com/article/3397320/fitbit-inspire-hr-review.html>>.

The New Fitbit Inspire HR Is Finally Available to the Public!, posted Mar. 6, 2019, [retrieved Jun. 5, 2019]. Retrieved from Internet, <URL: <https://amyeverafter.com/new-fitbit-inspire-hr-srnatwatch/>>.

Samsung’s 6th smartwatch has a 3G modern and a massive curved display, posted Aug. 28, 2014, [retrieved Jun. 5, 2019]. Retrieved from Internet, <URL: <https://arstechnica.com/gadgets/2014/08/samsungs-6th-smartwatch-has-a-3g-modern-and-a-massive-curved-display/>>.

Microsoft Band 2 Fitness Tracker with Curved Screen Announced, posted Oct. 7, 2015, [retrieved Jun. 5, 2019]. Retrieved from Internet, <URL: <https://gadgets.in.com/microsoft-band-2-fitness-tracker-with-curved-screen-announced.html>>.

Samsung Introduces Three New Wearables for Balanced and Connected Living, Samsung Newsroom, posted Feb. 20, 2019, accessed Feb. 25, 2019. <URL: <https://news.samsung.com/us/samsung-wearable-galaxy-watch-active-galaxy-fit-galaxy-buds-unpacked-2019/>>.

Wang et al., “Integrity Protection for Code-On-Demand Mobile Agents,” *Journal of Systems and Software*, vol. 60, Issue 3, pp. 211-221, downloaded from: <https://www.researchgate.net/researcher/9579357TianhanWang>, Feb. 15, 2002.

Seifert, “Making Time: how Pebble built its next smartwatch,” downloaded from: <http://www.theverge.com/2015/2124/8091175/pebble-time-watchwearable-platform-eric-migicovsky-interview>, The Verge, Feb. 24, 2015.

Fitbit Charge 3 leak hints at massive changes, posted Aug. 14, 2018, [retrieved Jan. 29, 2019]. Retrieved from Internet, <URL: <https://www.slashgear.com/fitbit-charge-3-leak-hints-at-massive-changes-14541228/>>.

New Fitbit is a waterproof smartwatch in disguise, posted Aug. 28, 2018, [retrieved Jan. 29, 2019]. Retrieved from Internet, <URL: [https://www.fox5vegas.com/archives/new-fitbit-is-a-waterproof-smartwatch-in-disguise/article\\_277bf36f-2e79-5b48-b490-1abce7603fae.html](https://www.fox5vegas.com/archives/new-fitbit-is-a-waterproof-smartwatch-in-disguise/article_277bf36f-2e79-5b48-b490-1abce7603fae.html)>.

Silicone Rubber Waterproof Watch Strap Band FORTE Spring Bars, for sale at eBay (<https://www.ebay.com.au/itm/Silicone-Rubber-Waterproof-Watch-Strap-Band-FORTE-Spring-Bars-20mm-22mm-24mm-/272077865335>). Website accessed Dec. 6, 2019.

Kartice Compatible with Fitbit Inspire Bands/Fitbit Inspire HR Bands, for sale at [www.amazon.com](http://www.amazon.com). Website accessed Jun. 10, 2019.

Tuscom Replacement Bands Compatible with Fitbit Inspire and Fitbit Inspire HR, for sale at [www.amazon.com](http://www.amazon.com). Website accessed Jun. 10, 2019.

ACBEE Fitbit alta Band, Watch Buckle Design, for sale on amazon.com ([https://www.amazon.com/ACBEE-Perfect-Replacement-Original-Band-Neve/dp/B01G2IECXO/ref=as\\_li\\_ss\\_tlie=UTF8&linkCode=sll1&tag=mbyte-20&linkId=d7045d83d76ae70cec2212,2019.55ad2f282088&linkCode=w61&imprToken=n-LMJ6kaAeLbRPMusOUq7A&slotNum=14](https://www.amazon.com/ACBEE-Perfect-Replacement-Original-Band-Neve/dp/B01G2IECXO/ref=as_li_ss_tlie=UTF8&linkCode=sll1&tag=mbyte-20&linkId=d7045d83d76ae70cec2212,2019.55ad2f282088&linkCode=w61&imprToken=n-LMJ6kaAeLbRPMusOUq7A&slotNum=14)). Website accessed Jun. 12, 2019.

Gold premium NATO strap Le Mans, for sale at [cheapestnatostraps.com](http://cheapestnatostraps.com) (<https://www.cheapestnatostraps.com/products/gold-premium-nato-strap-le-mans>). Website accessed Dec. 6, 2019.

Alfawise H19 RFID Sports Smartwatch Fitness Tracker for sale at gearbest.com ([https://www.gearbest.com/smart-watches/pp\\_009207049039.html?wid=1433363](https://www.gearbest.com/smart-watches/pp_009207049039.html?wid=1433363)). Website accessed Dec. 6, 2019.

Fitbit Versa Smartwatch and Activity Tracker with Classic Band for sale at HSN (<https://www.hsn.com/products/fitbit-versa-smartwatch-and-activity-tracker-with-class/8688605>). Website accessed Dec. 6, 2019.

(56)

**References Cited**

OTHER PUBLICATIONS

Fitbit Versa Smartwatch for sale at kohls.com (<https://www.kohls.com/product/prd-3296179/fitbit-versa-smart-fitness-watch-non-nfc.jsp>). Website accessed Dec. 6, 2019.

Princeton University 18mm NATO Watch Strap with Silver Fittings for sale at Smart Turnout (<https://smartturnout.com/university-watchstrap-princeton-university/>). Website accessed Dec. 6, 2019.

Fitbit Ace 2 activity tracker for kids 6+, for sale at fitbit.com (<https://www.fitbit.com/us/products/trackers/ace2?sku=414BKBU>). Website accessed Jan. 2020.

Samsung Galaxy Fit, Black, available from Samsung (<https://www.samsung.com/us/mobile/wearables/smart-fitness-bands/samsung-galaxy-fit-sm-r370nzkaxar/>). Website accessed Mar. 16, 2020.

“Colorful TPE Strap Replacement Sport Wrist Watch Band for Xiaomi Miband 3 Miband 4—No. 2” available from Banggood ([https://www.banggood.in/Colorful-TPE-Strap-Replacement-Sport-Wrist-Watch-Band-for-Xiaomi-Miband-3-Miband-4-p-1307559.html?ID=529070&cur\\_warehouse=CN](https://www.banggood.in/Colorful-TPE-Strap-Replacement-Sport-Wrist-Watch-Band-for-Xiaomi-Miband-3-Miband-4-p-1307559.html?ID=529070&cur_warehouse=CN)). Website accessed Mar. 16, 2020.

\* cited by examiner



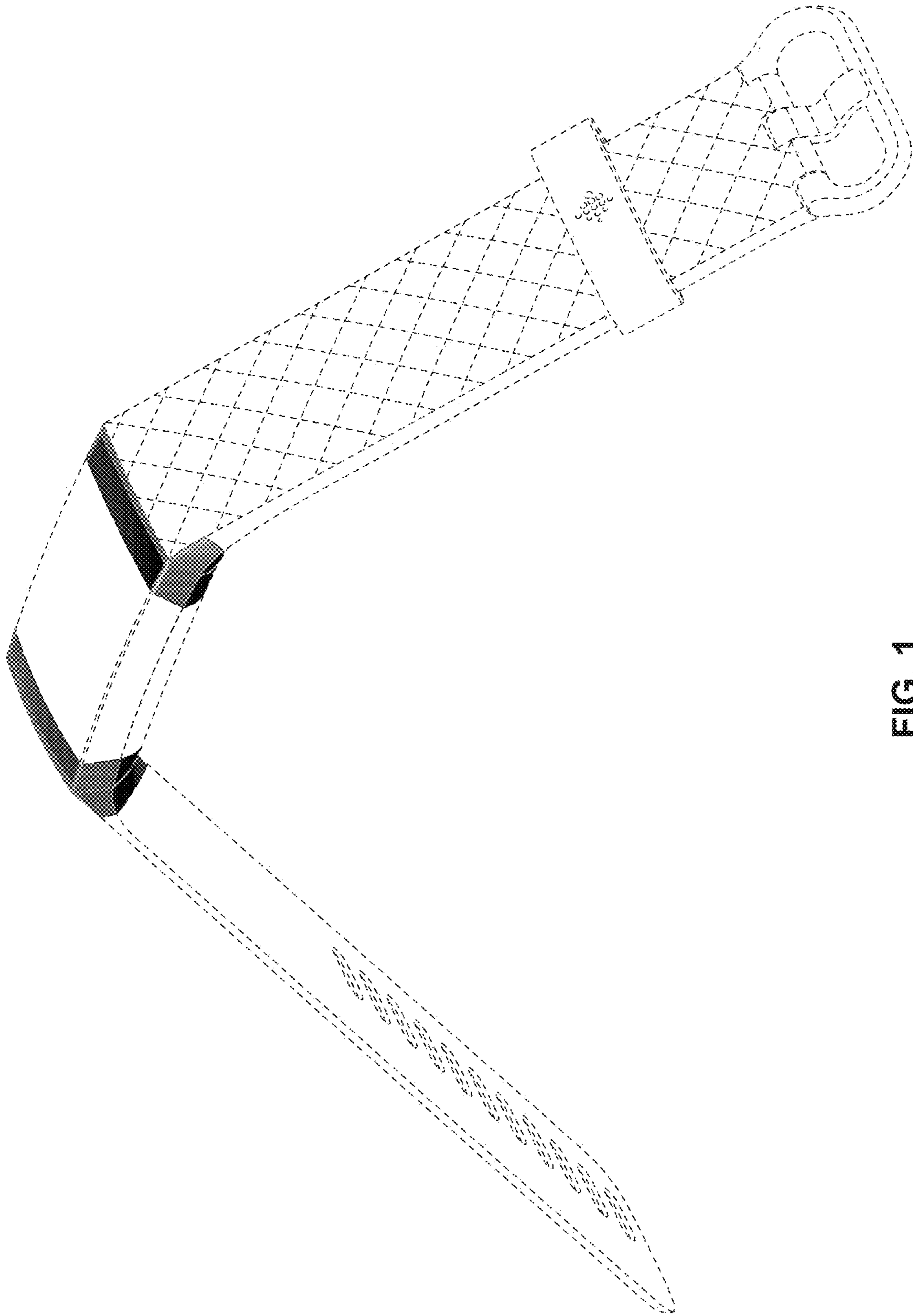

FIG. 1

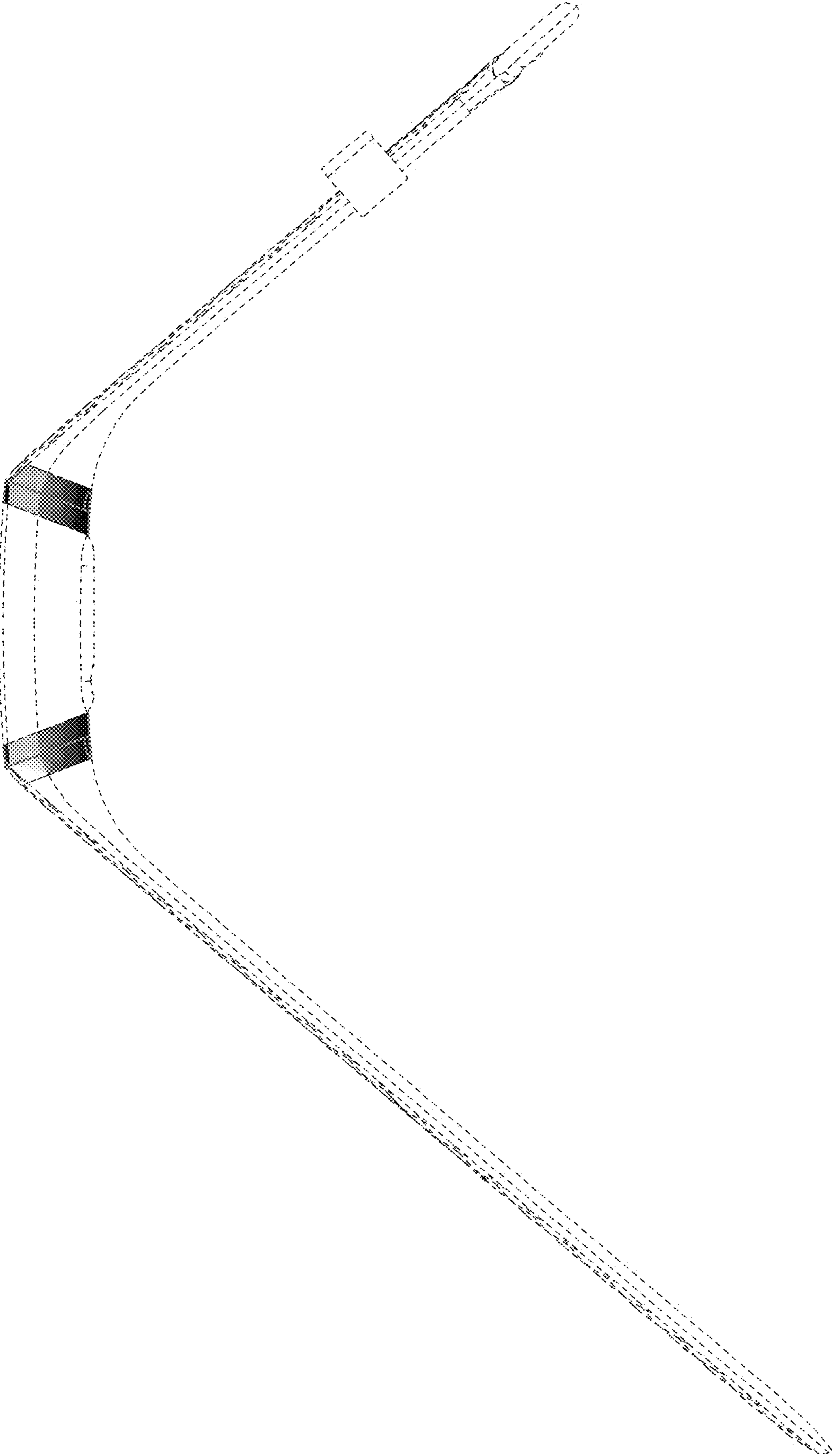

FIG. 2

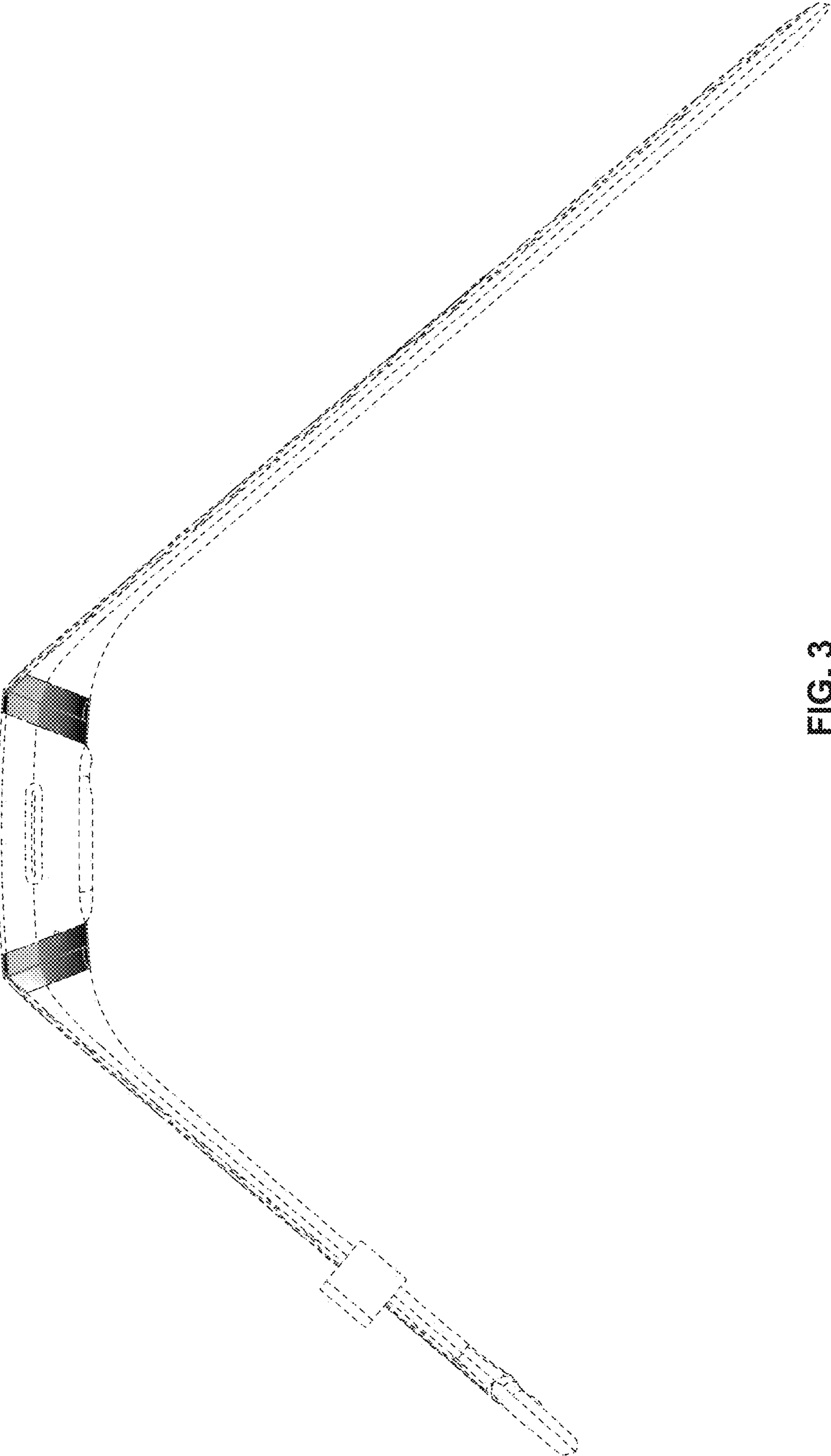

FIG. 3

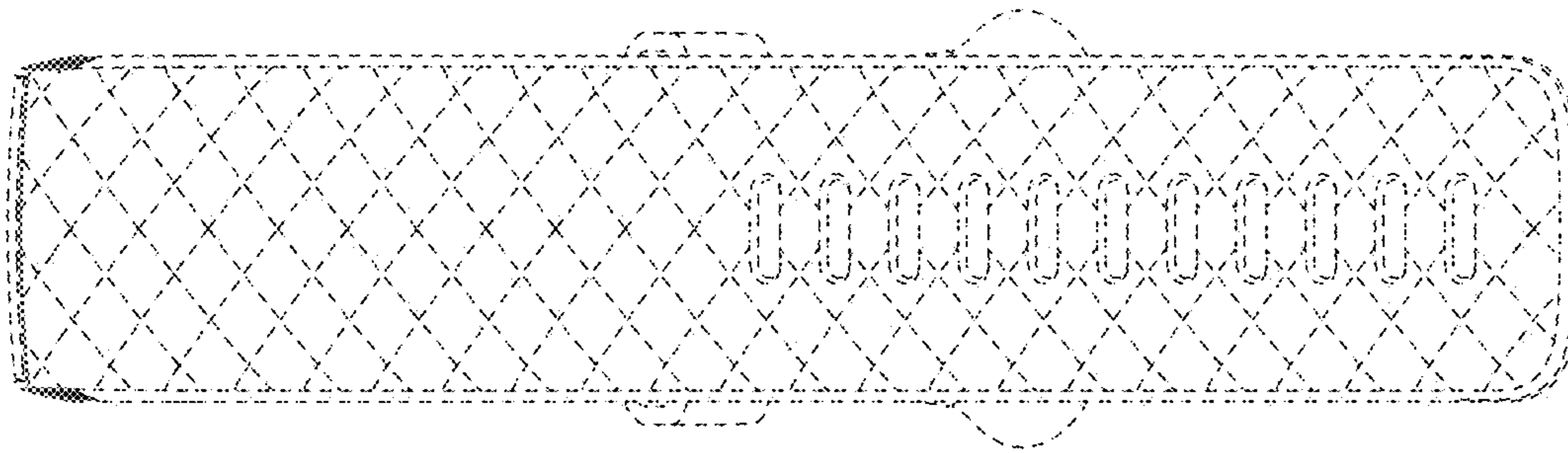

FIG. 5

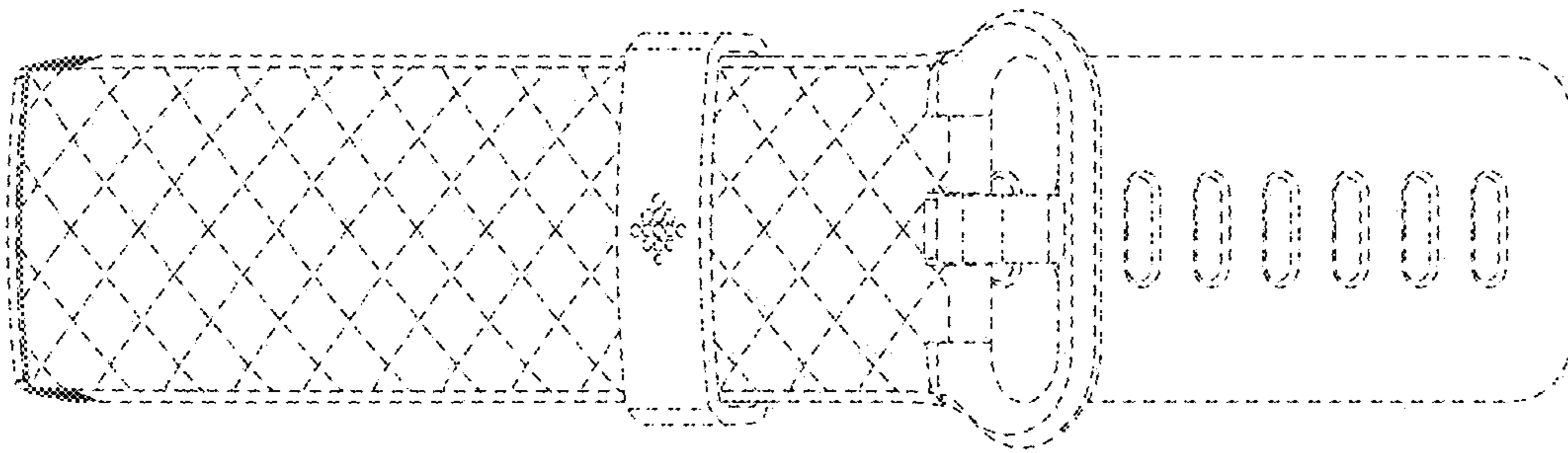

FIG. 4



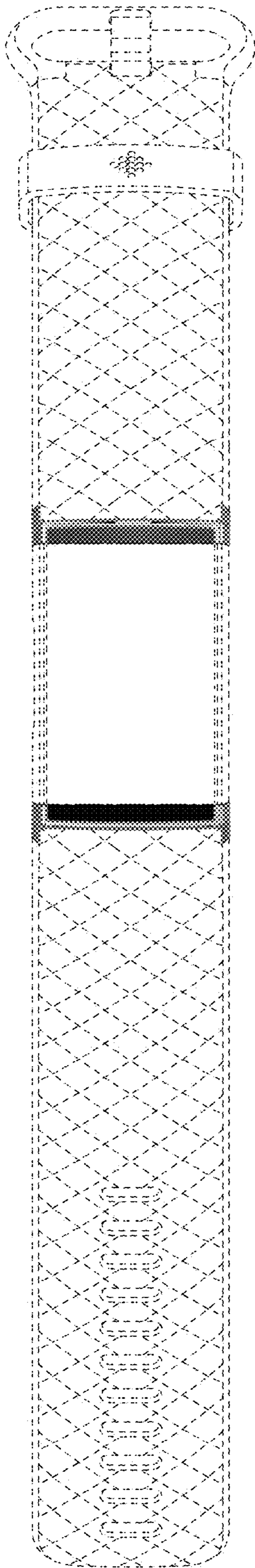

FIG. 6

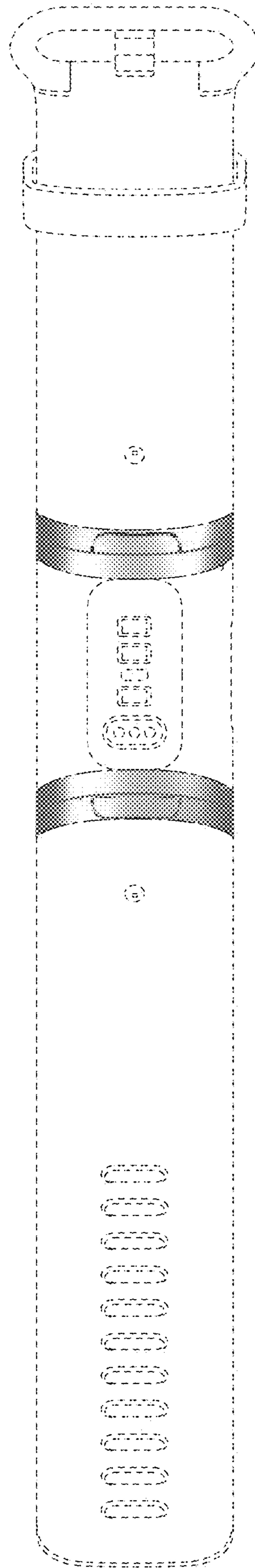

FIG. 7

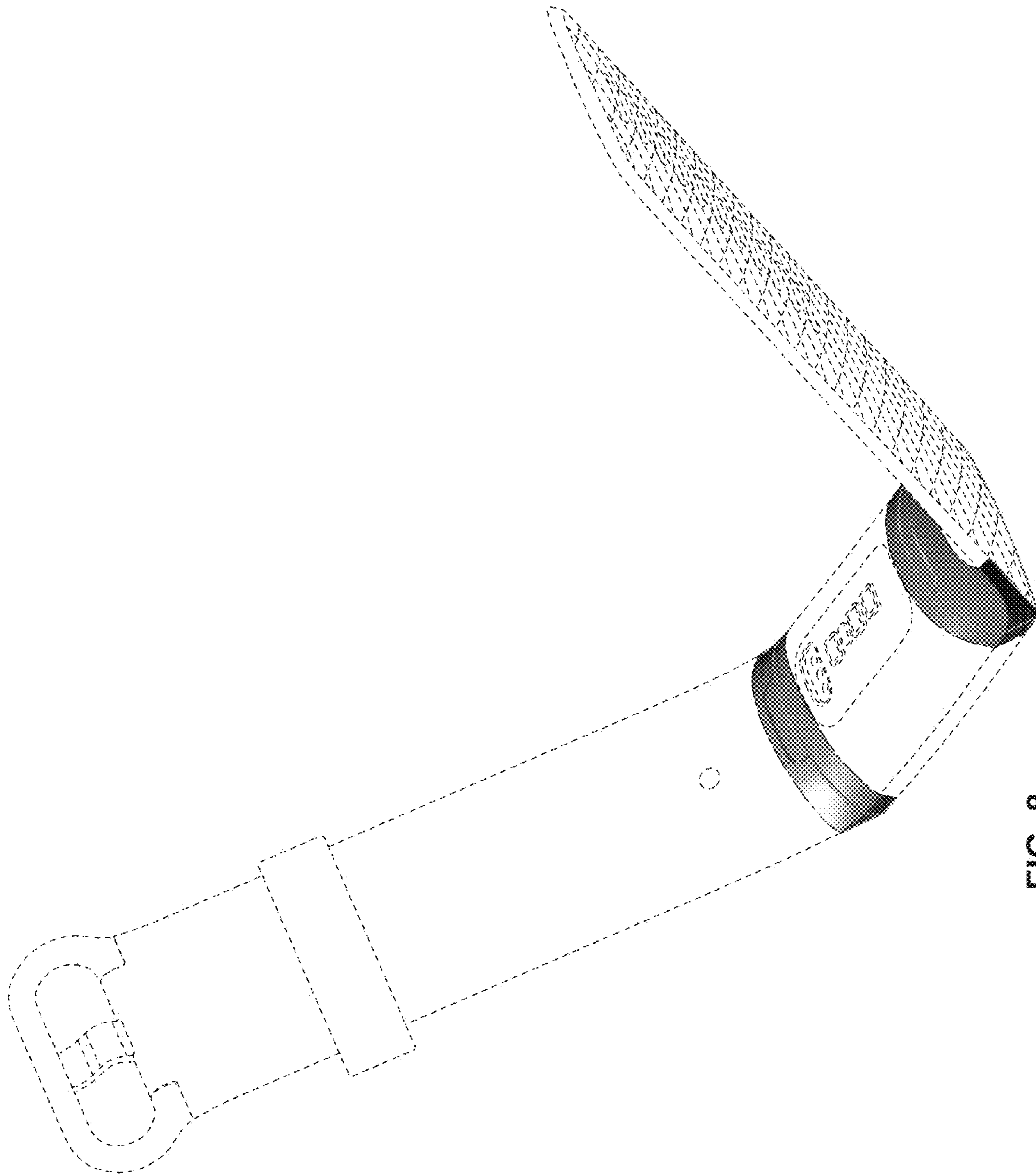

FIG. 8