



US00D922345S

(12) **United States Design Patent**
Bae et al.

(10) **Patent No.:** **US D922,345 S**
(45) **Date of Patent:** **** Jun. 15, 2021**

(54) **MOBILE PHONE**

- (71) Applicant: **LG ELECTRONICS INC.**, Seoul (KR)
- (72) Inventors: **Jinwan Bae**, Seoul (KR); **Jonghak Lee**, Seoul (KR); **Joungyoung Joung**, Seoul (KR)
- (73) Assignee: **LG ELECTRONICS INC.**, Seoul (KR)
- (**) Term: **15 Years**
- (21) Appl. No.: **29/681,016**
- (22) Filed: **Feb. 21, 2019**

(30) **Foreign Application Priority Data**

Aug. 21, 2018 (KR) 30-2018-0038824

(51) **LOC (13) Cl.** **14-03**

(52) **U.S. Cl.**
USPC **D14/138 AB; D14/345**

(58) **Field of Classification Search**
USPC D14/129-130, 137, 138 AA, 138 AB, D14/138 AC, 138 AD, 138 C, 138 G, D14/138 R, 147, 203.3-203.8, 218, 240, D14/247, 248, 315-318, 341-347, 371, D14/374, 388-389, 420, 426, 496; D6/308, 310; D10/50, 65, 104.1; D18/6-7; D19/26, 59-60; D21/324, D21/329-330, 332

(Continued)

(56) **References Cited**

U.S. PATENT DOCUMENTS

- D776,108 S * 1/2017 Hsu D14/341
- D788,772 S * 6/2017 Kim D14/341

(Continued)

OTHER PUBLICATIONS

Are Foldable Phones a Gimmick or the Next Big Thing?, date not available, [retrieved Dec. 3, 2020], Retrieved from Internet, URL: <<https://www.brainbridge.be/news/are-foldable-phones-a-gimmick-or-the-next-big-thing>> (Year: 2020).*

(Continued)

Primary Examiner — Barbara Fox
Assistant Examiner — Aram Kwon

(74) *Attorney, Agent, or Firm* — Birch, Stewart, Kolasch & Birch LLP

(57) **CLAIM**

The ornamental design for a mobile phone, as shown and described.

DESCRIPTION

FIG. 1 is a front perspective view of a mobile phone showing our new design in a folded state;
FIG. 2 is a front view thereof;
FIG. 3 is a rear view thereof;
FIG. 4 is a left side view thereof;
FIG. 5 is a right side view thereof;
FIG. 6 is a top plan view thereof;
FIG. 7 is a bottom plan view thereof;
FIG. 8 is a rear perspective view thereof;
FIG. 9 is a front perspective view of the mobile phone showing our new design in a fully opened state;
FIG. 10 is a front view of FIG. 9;
FIG. 11 is a rear view of FIG. 9;
FIG. 12 is a left side view of FIG. 9;
FIG. 13 is a right side view of FIG. 9;
FIG. 14 is a top plan view of FIG. 9;
FIG. 15 is a bottom plan view of FIG. 9; and,
FIG. 16 is a rear perspective view of FIG. 9.
The broken lines depict portions of the mobile phone that form no part of the claimed design.

1 Claim, 16 Drawing Sheets

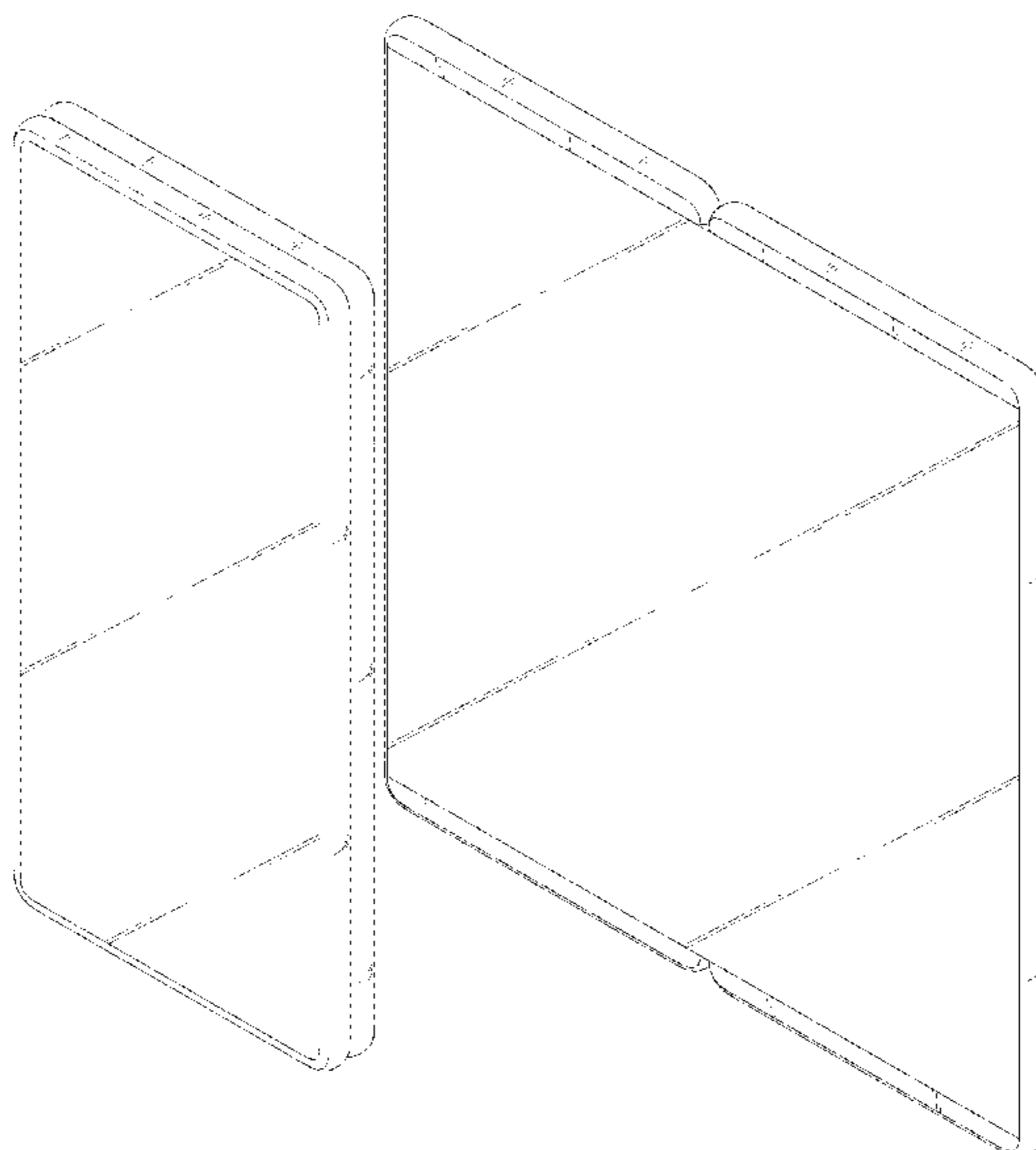

(58) **Field of Classification Search**

CPC G06F 1/1613; G06F 1/1626; G06F 3/0488;
 G06F 3/04886; H04M 1/725; H04M
 1/0202; H04M 1/0266

See application file for complete search history.

(56) **References Cited**

U.S. PATENT DOCUMENTS

D813,214	S	*	3/2018	Fan	D14/248
D832,805	S	*	11/2018	Xu	D14/138 G
D842,833	S	*	3/2019	Seo	D14/138 AB
D852,157	S	*	6/2019	Lin	D14/248
D859,381	S	*	9/2019	Lin	D14/248
D864,953	S	*	10/2019	Ahn	D14/341
D892,782	S	*	8/2020	Liu	D14/248
D897,302	S	*	9/2020	Lee	D14/138 AB
2020/0352038	A1	*	11/2020	Kim	H05K 5/0017

OTHER PUBLICATIONS

LG smartphone allows flexible display to fold outwards, Jan. 3, 2019 [online], [retrieved Dec. 3, 2020], Retrieved from Internet, URL: <<https://nl.letsgodigital.org/smartphones/lg-vouwbare-smartphone/>> (Year: 2019).*

LG's Dual Screen 'foldable phone' breaks apart, Feb. 24, 2019 [online], [retrieved Dec. 3, 2020], Retrieved from Internet, URL: <<https://www.bbc.com/news/technology-47352129>> (Year: 2019).*

Microsoft's Foldable Surface Phone, Jan. 31, 2019 [online], [retrieved Dec. 3, 2020], Retrieved from Internet, URL: <<https://www.forbes.com/sites/jaymcgregor/2019/01/31/microsofts-foldable-surface-phone-needs-two-features/?sh=31aa329562f3>> (Year: 2019).*

* cited by examiner

FIG. 1

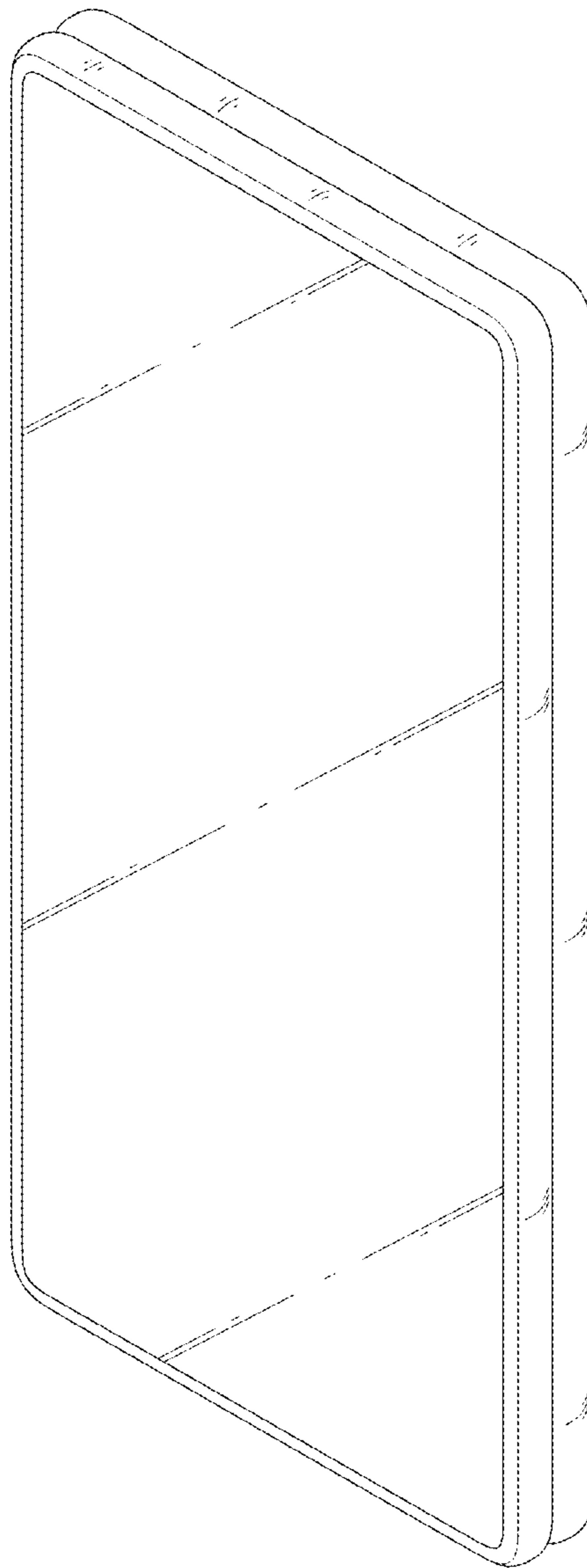

FIG. 2

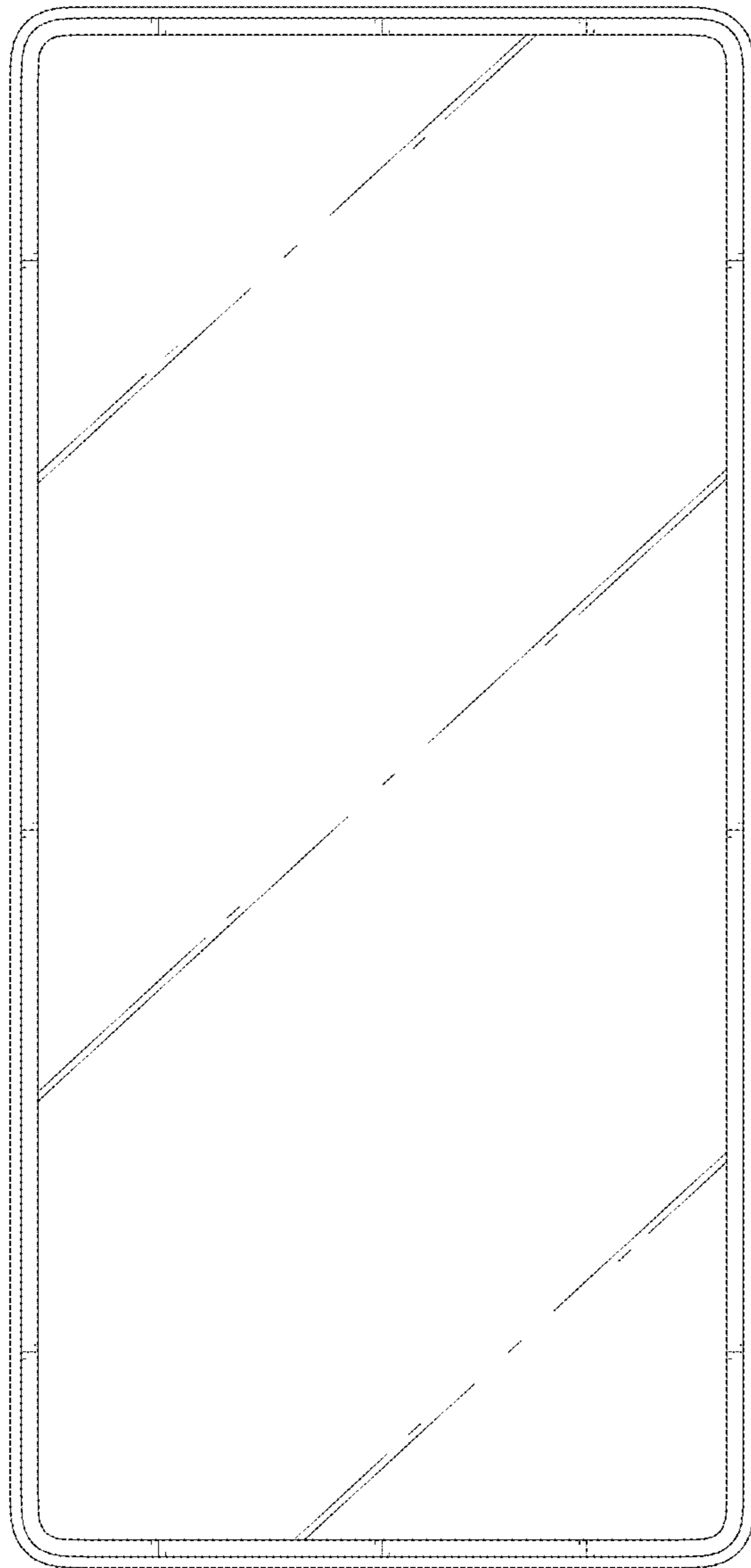

FIG. 3

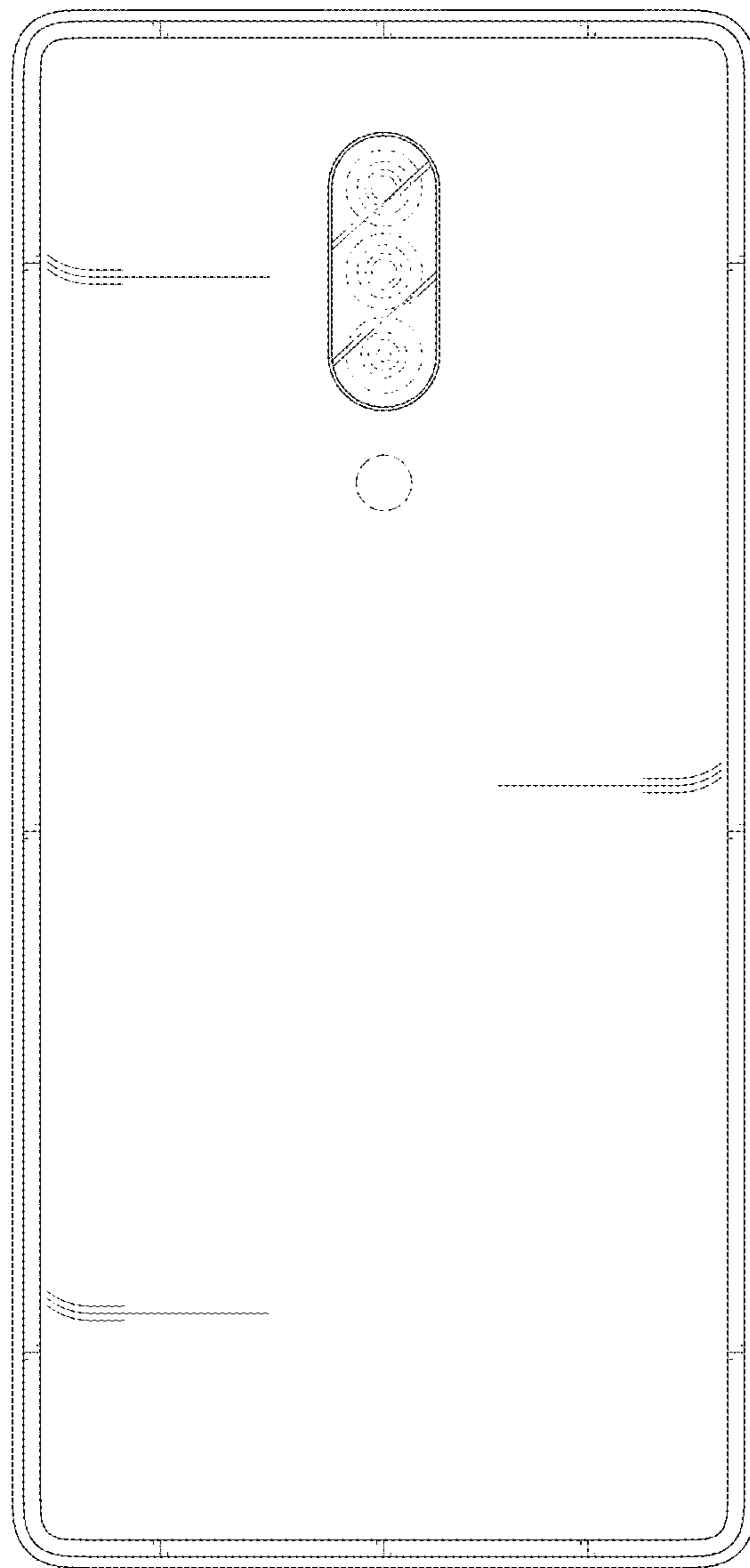

FIG. 4

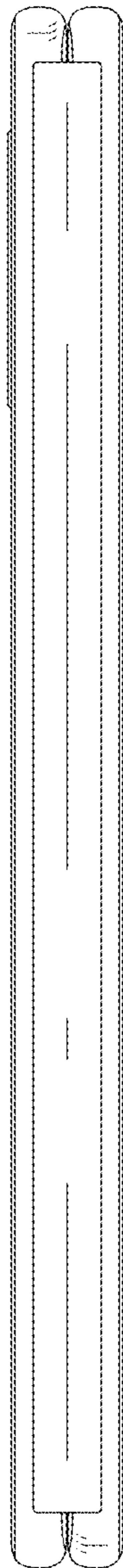

FIG. 5

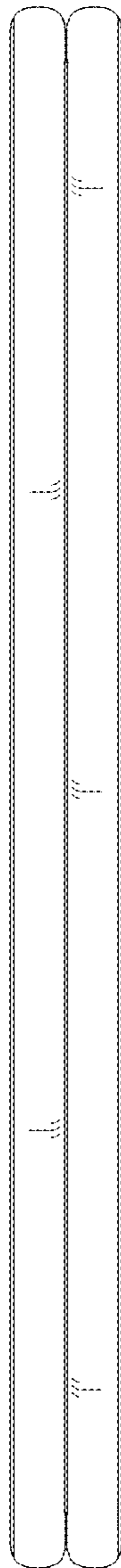

FIG. 6

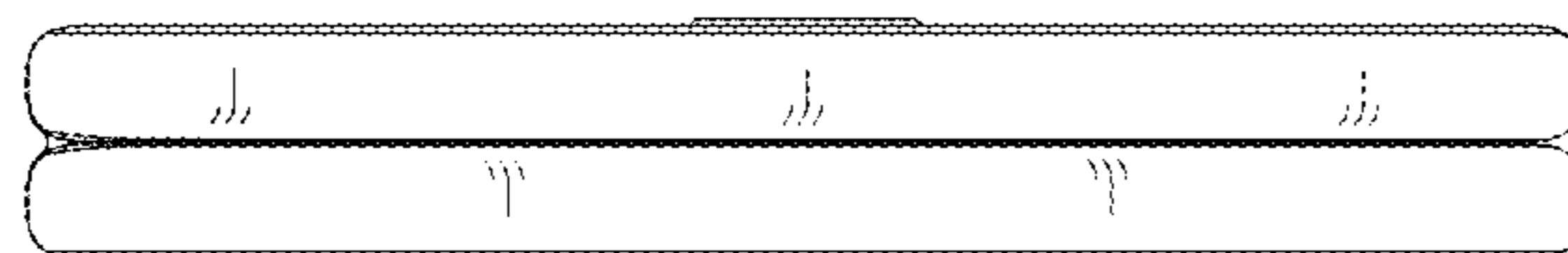

FIG. 7

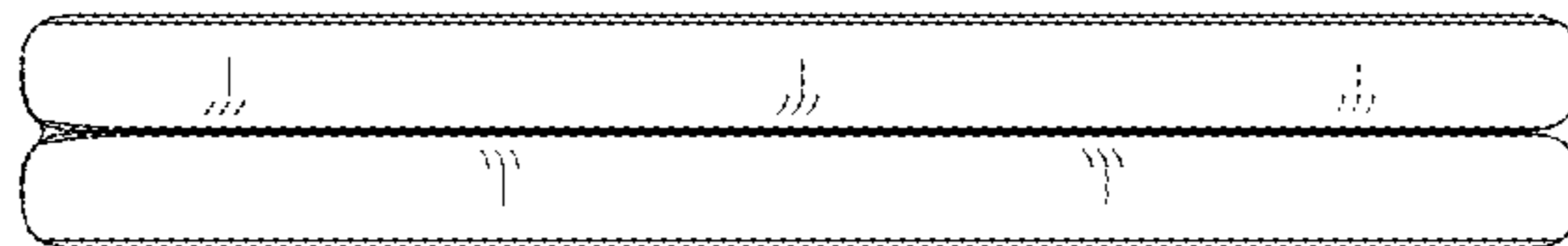

FIG. 8

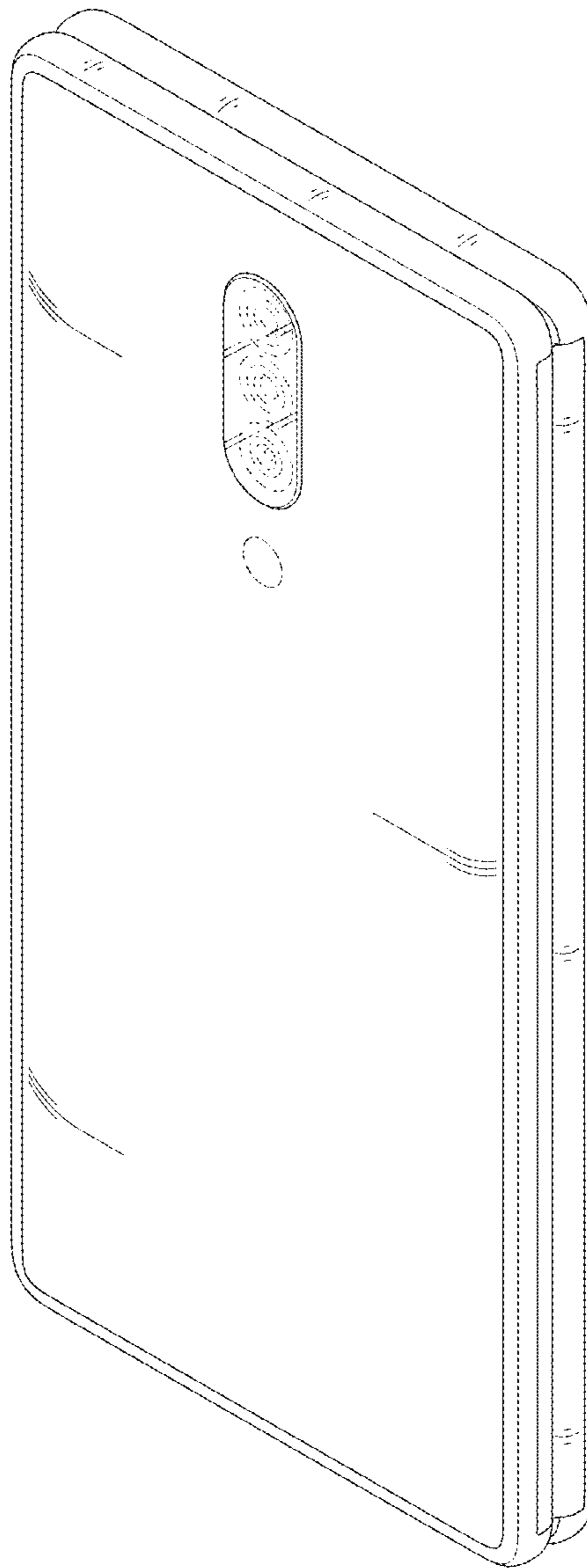

FIG. 9

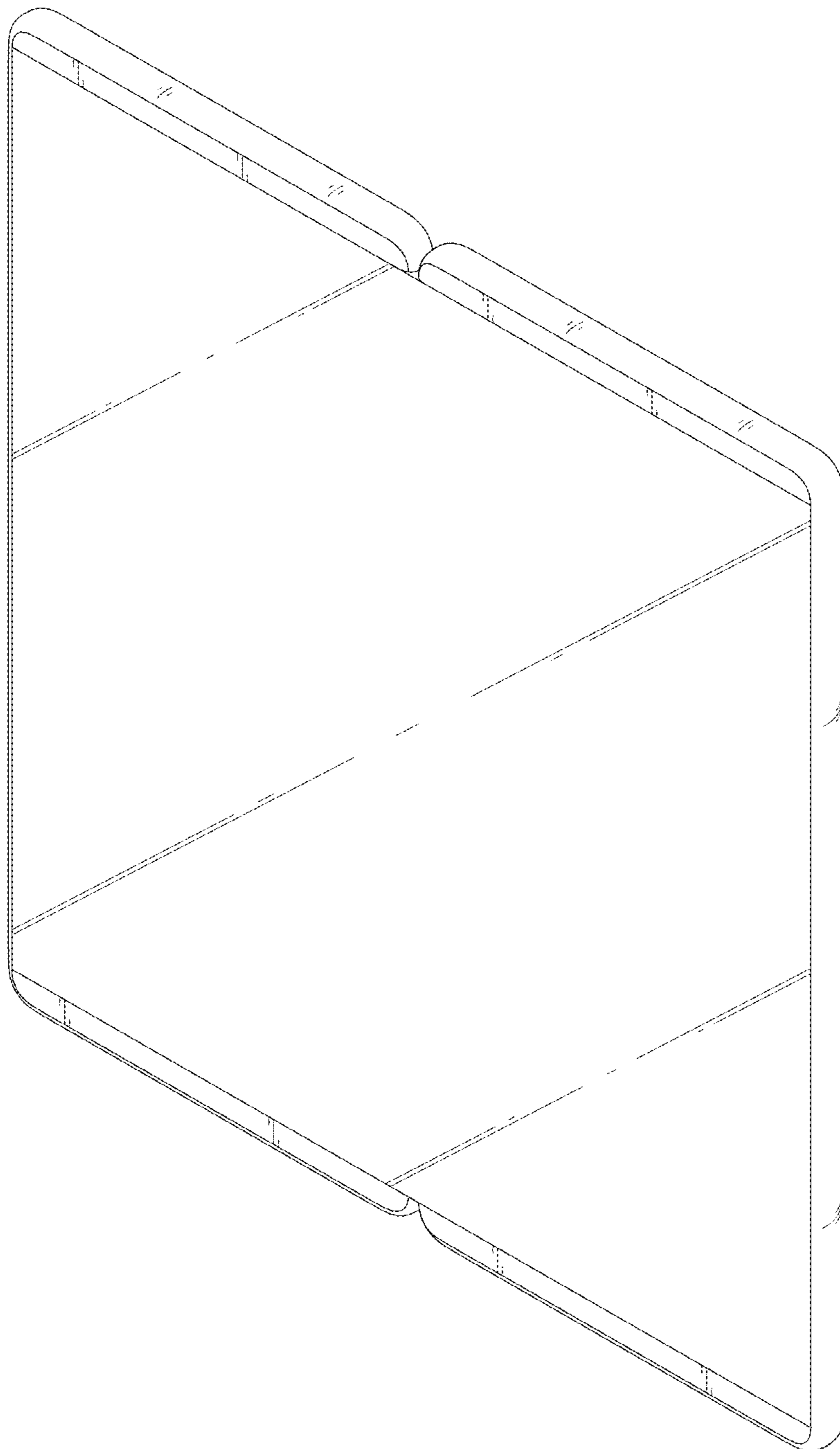

FIG. 10

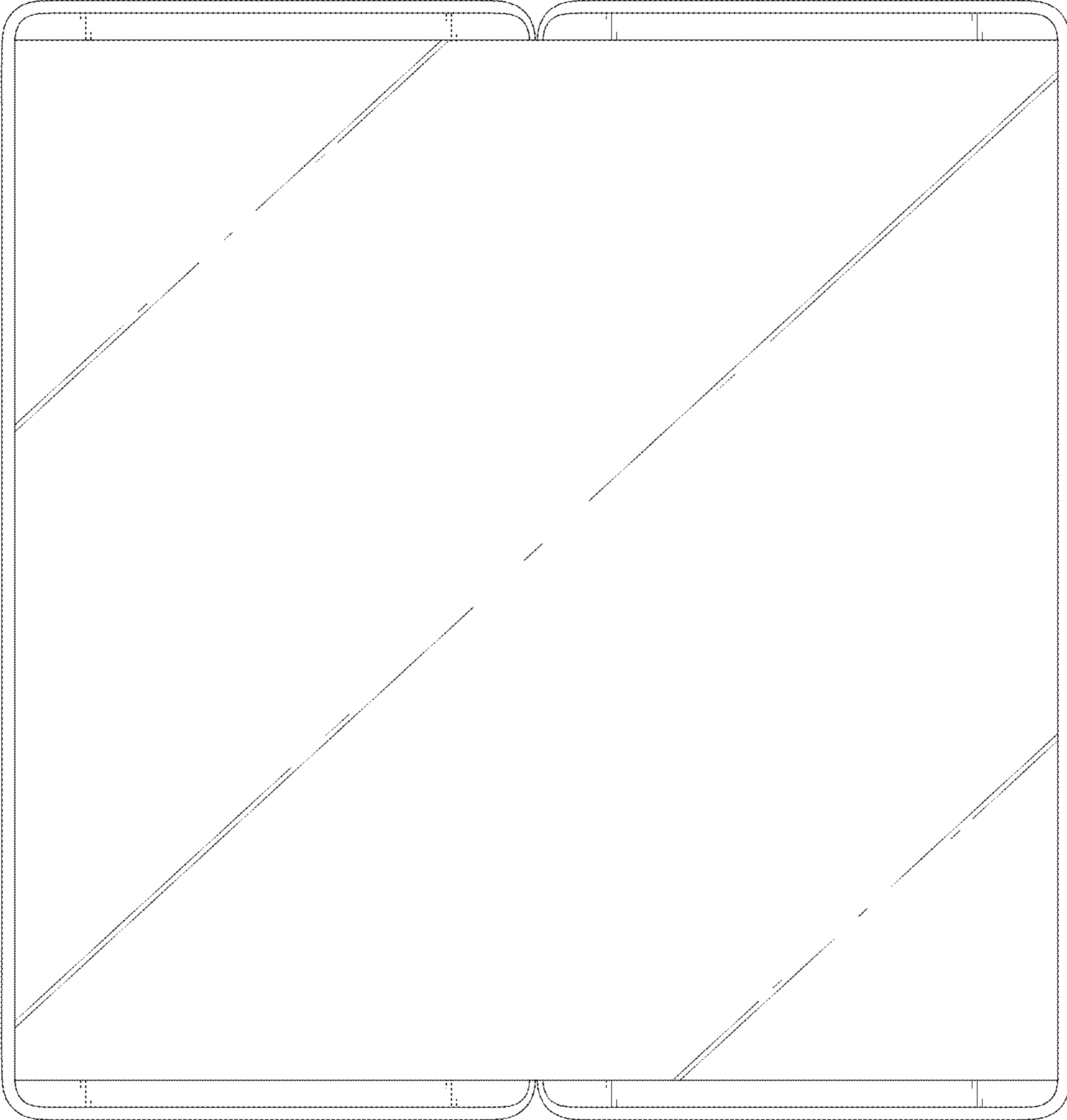

FIG. 11

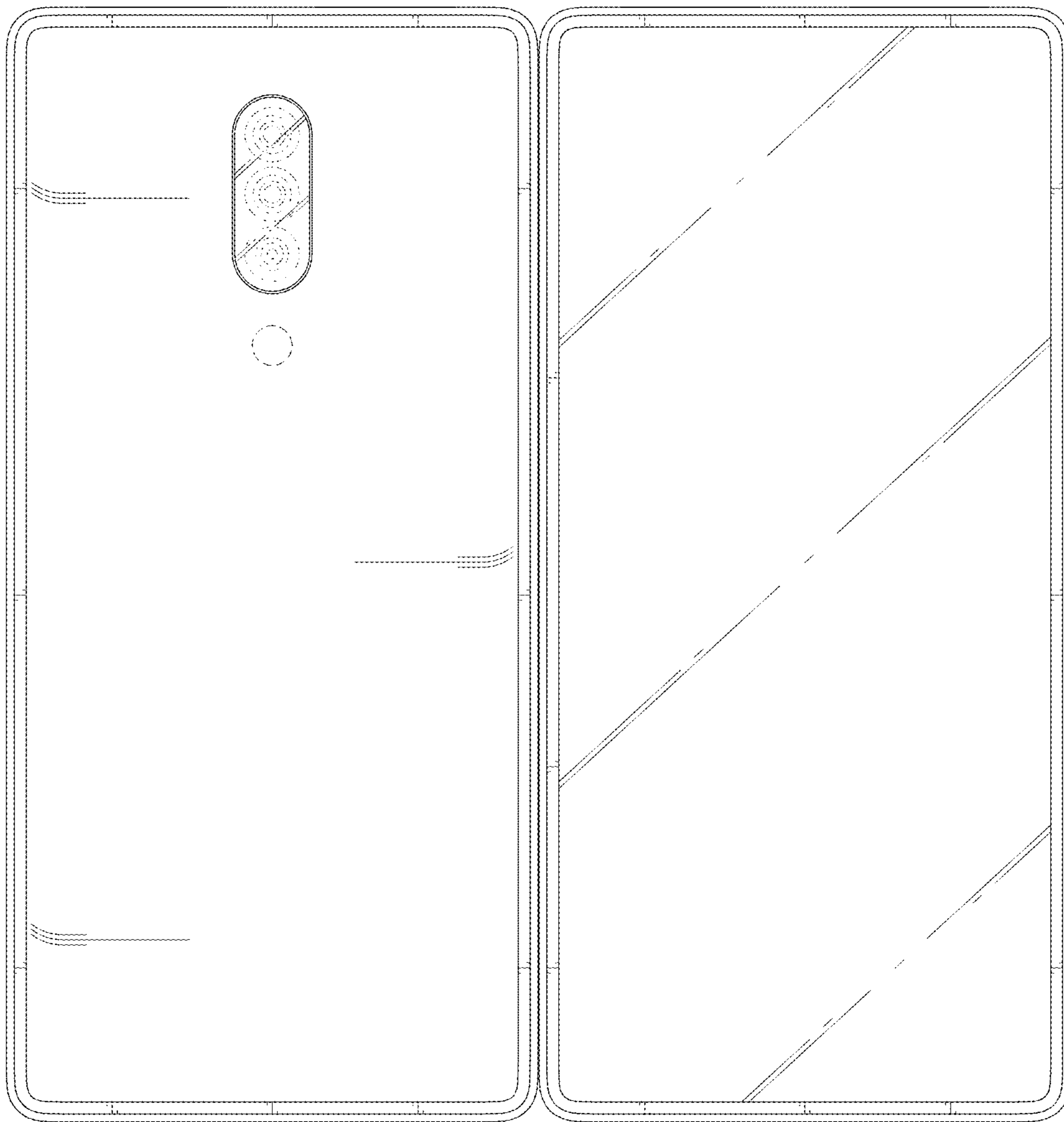

FIG. 12

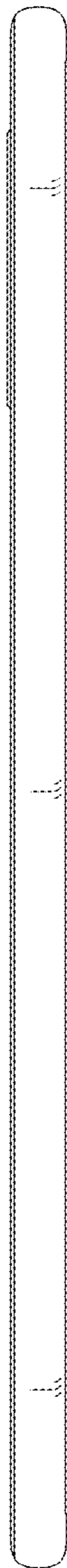

FIG. 13

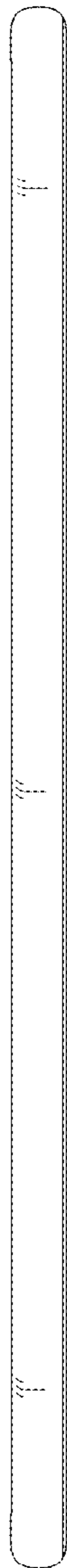

FIG. 14

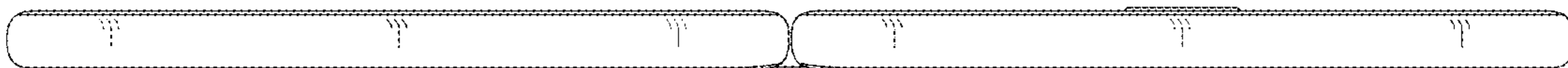

FIG. 15

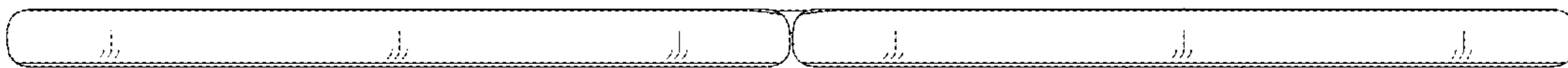

FIG. 16

