



US00D922263S

(12) **United States Design Patent**
McCuskey

(10) **Patent No.:** **US D922,263 S**

(45) **Date of Patent:** **** *Jun. 15, 2021**

(54) **DROP DOWN TRAILER HITCH V**

D857,565 S * 8/2019 McCuskey D12/162
D862,306 S * 10/2019 Porath B60D 1/605

(71) Applicant: **Scott McCuskey**, Boardman, OH (US)

D12/162
D862,308 S * 10/2019 Siegel D12/162

(72) Inventor: **Scott McCuskey**, Boardman, OH (US)

D873,723 S * 1/2020 Borkholder D12/162

(*) Notice: This patent is subject to a terminal disclaimer.

D876,290 S * 2/2020 Kirkland D12/162

D881,078 S * 4/2020 Rebick D12/162

D890,637 S * 7/2020 McCuskey D12/162

* cited by examiner

(**) Term: **15 Years**

Primary Examiner — Katrina A Betton

(21) Appl. No.: **29/701,904**

(74) *Attorney, Agent, or Firm* — Harpman & Harpman

(22) Filed: **Aug. 15, 2019**

(57) **CLAIM**

(51) **LOC (13) Cl.** **12-16**

The ornamental design for a drop down trailer hitch V, as shown and described.

(52) **U.S. Cl.**

DESCRIPTION

USPC **D12/162**

(58) **Field of Classification Search**

USPC D12/159–162

CPC . B60D 1/60; B60D 1/065; B60D 1/00; B60D 1/06; B60D 1/36

See application file for complete search history.

FIG. 1 is a front and right side perspective view of a fixed drop down trailer hitch V showing my new design; FIG. 2 is a right side elevational view thereof; FIG. 3 is a left side elevational view thereof; FIG. 4 is a top plan view thereof; FIG. 5 is a bottom plan view thereof; FIG. 6 is a rear elevational view thereof; FIG. 7 is a front elevational view thereof; and, FIG. 8 is a front and right side perspective view of the fixed drop down trailer hitch V with related environment in broken lines. The broken lines form no part of the claim and are shown only as relatable environment.

(56) **References Cited**

U.S. PATENT DOCUMENTS

| | | | | |
|--------------|--------|----------|-------|---------|
| D794,515 S * | 8/2017 | McCuskey | | D12/162 |
| D847,697 S * | 5/2019 | McCuskey | | D12/162 |
| D851,545 S * | 6/2019 | McCuskey | | D12/162 |
| D851,546 S * | 6/2019 | McCuskey | | D12/162 |
| D854,970 S * | 7/2019 | McCuskey | | D12/162 |
| D857,564 S * | 8/2019 | McCuskey | | D12/162 |

1 Claim, 6 Drawing Sheets

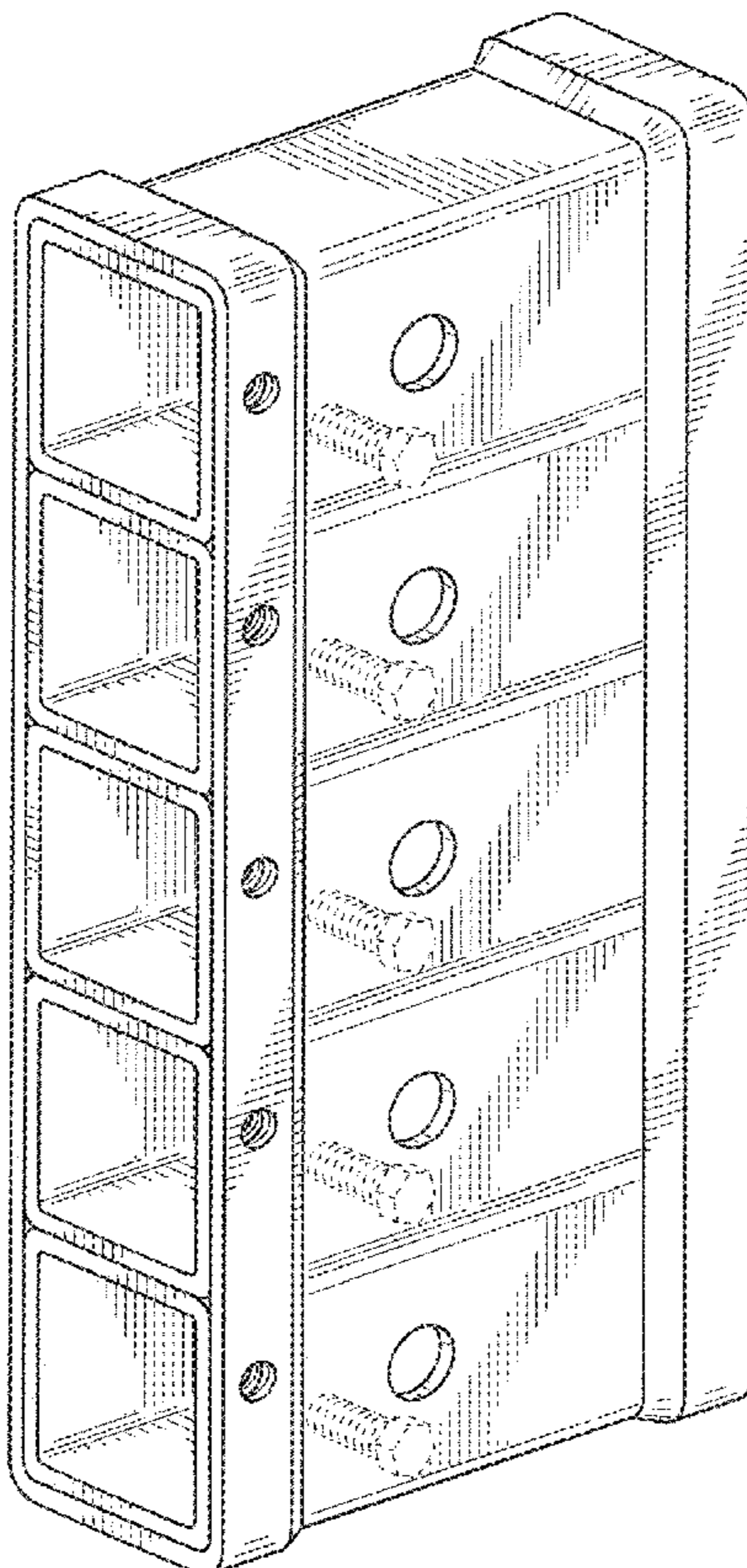

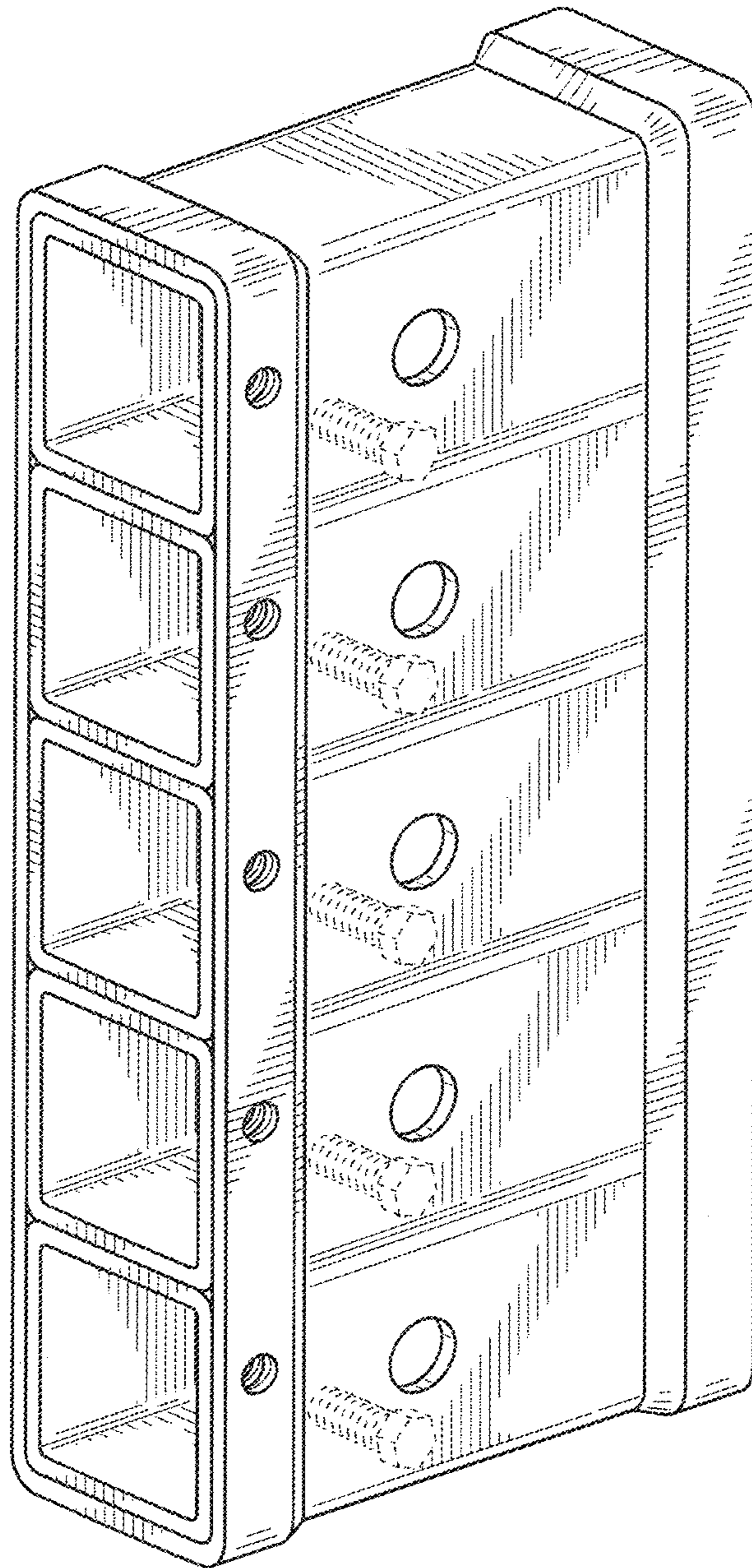

FIG. 1

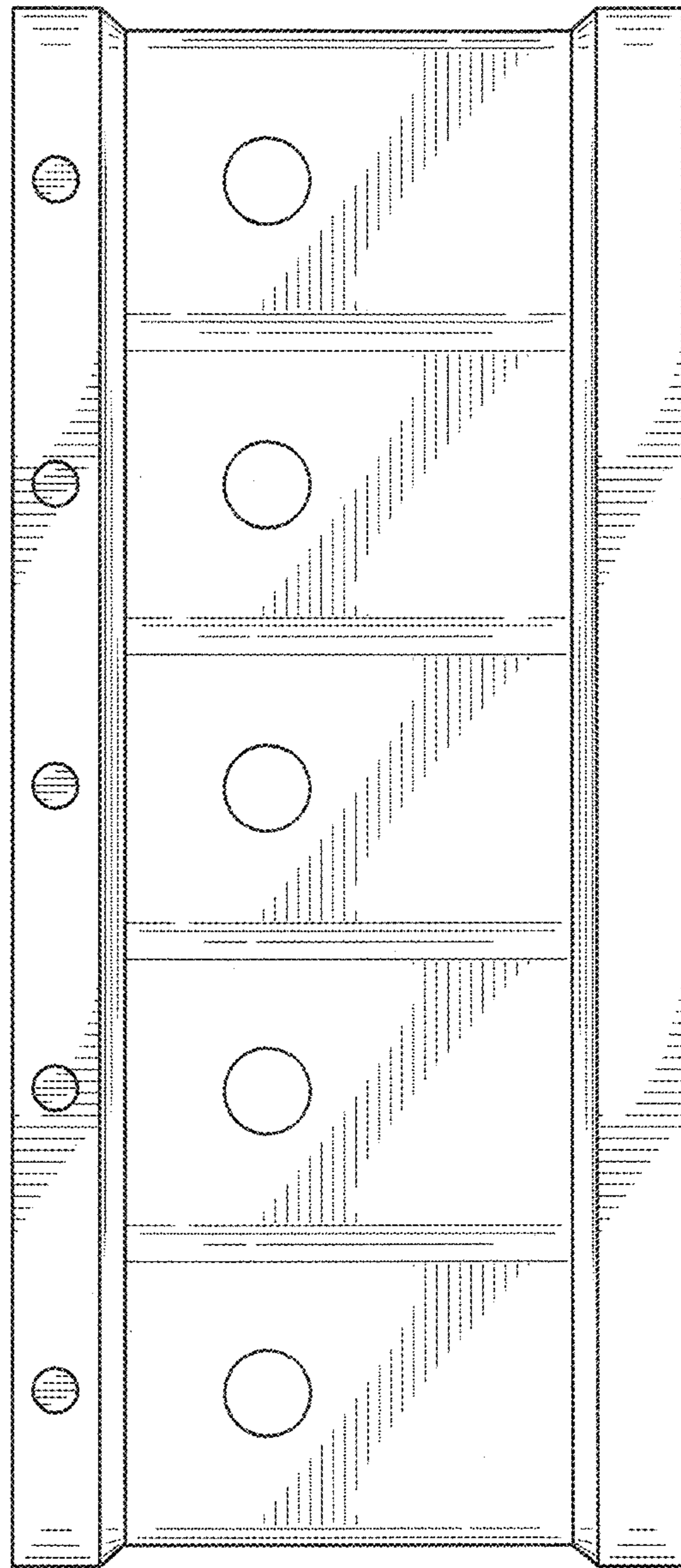

FIG. 2

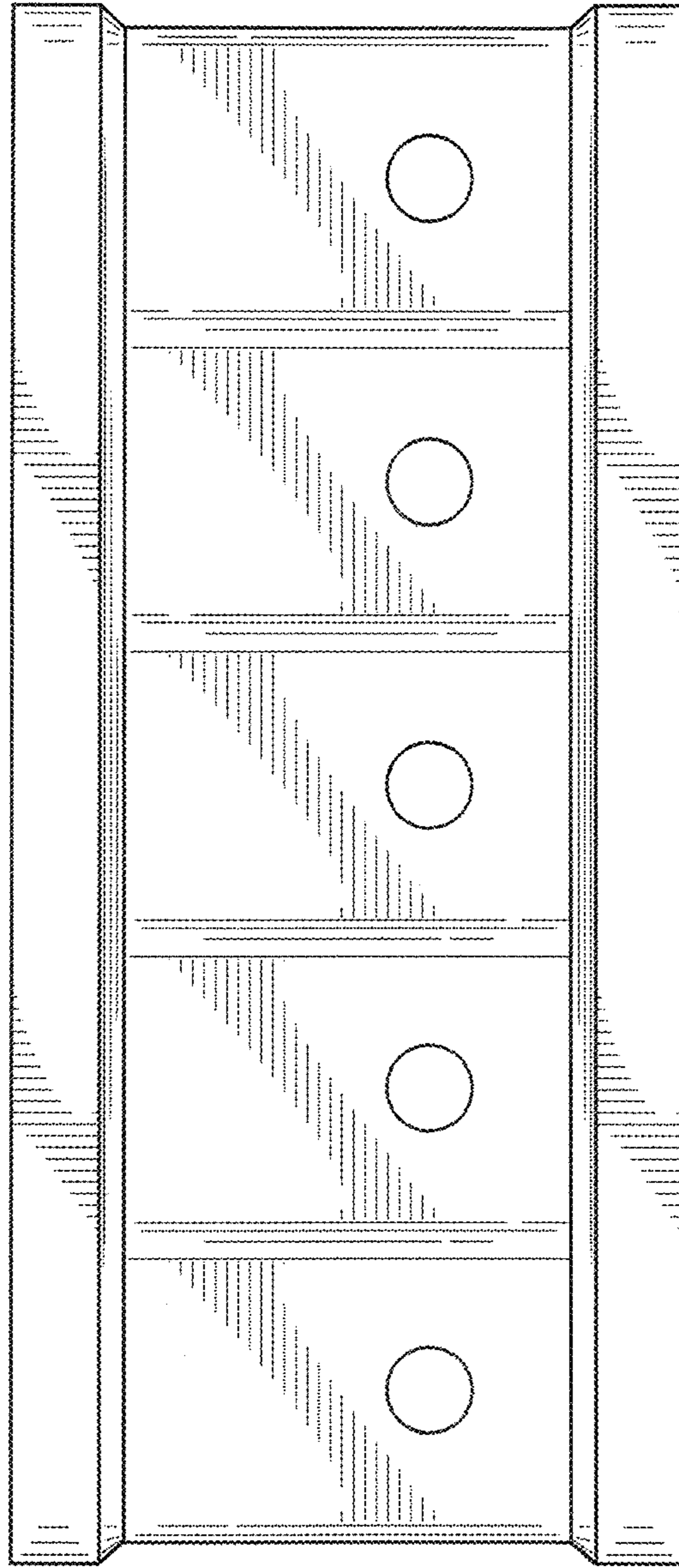

FIG. 3

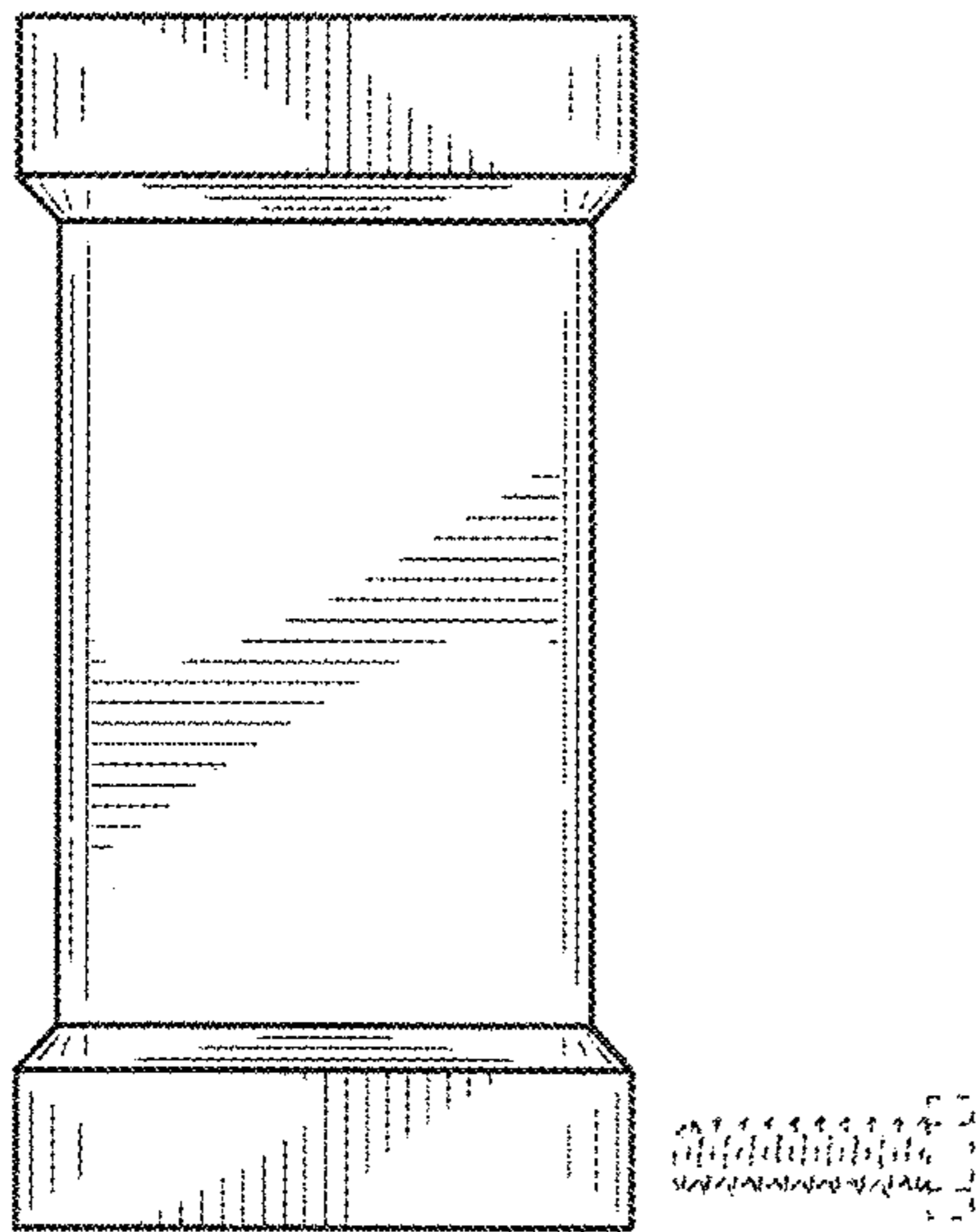

FIG. 4

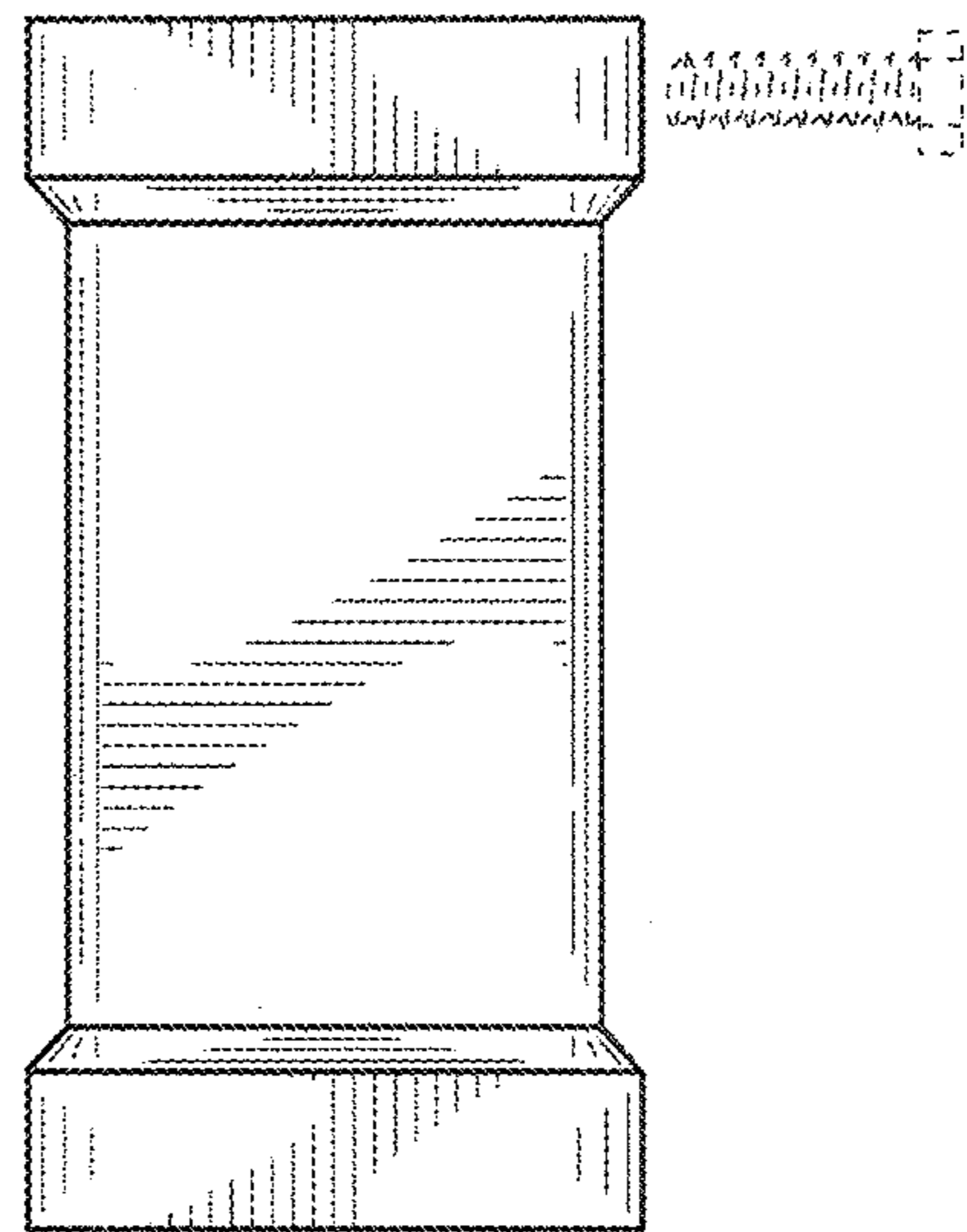

FIG. 5

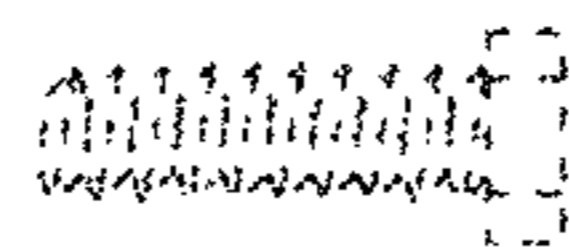
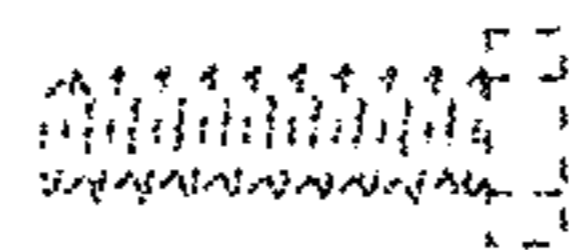
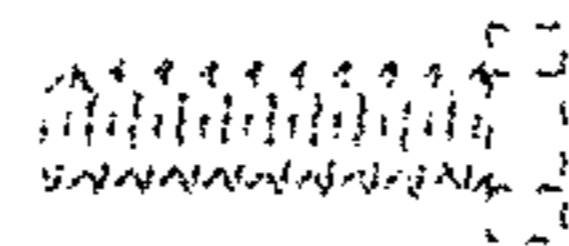
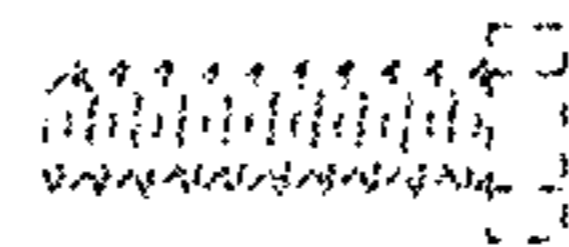
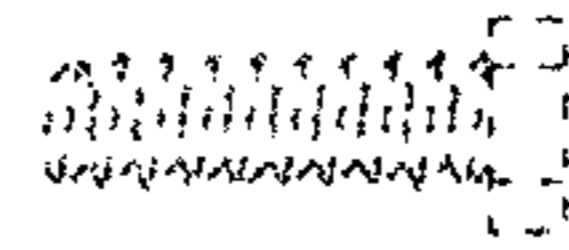
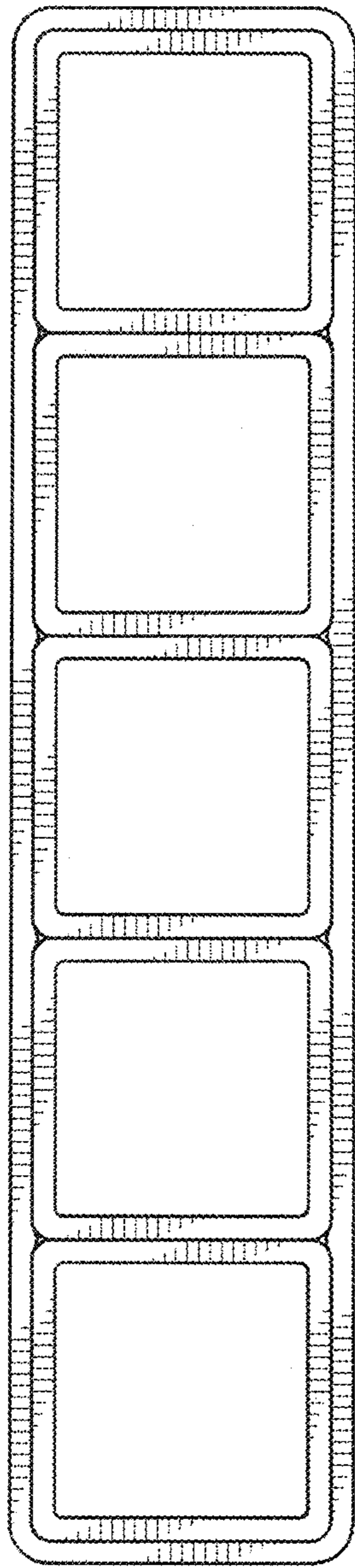

FIG. 6

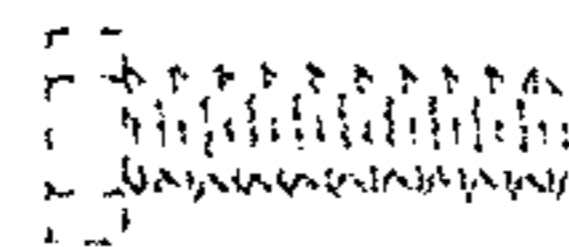
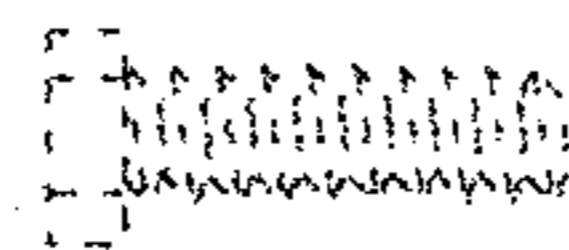
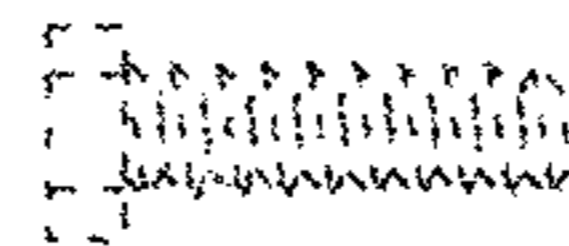
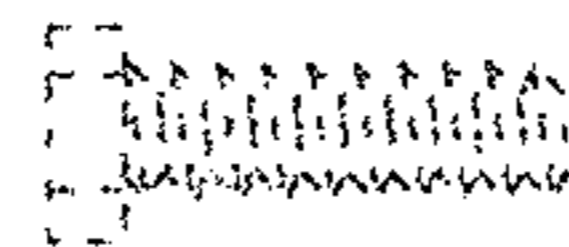
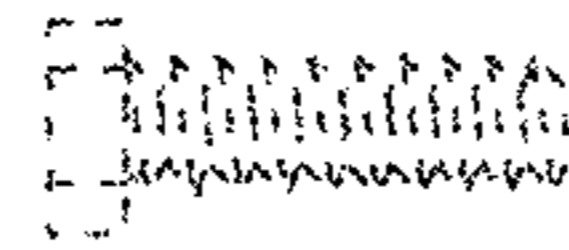
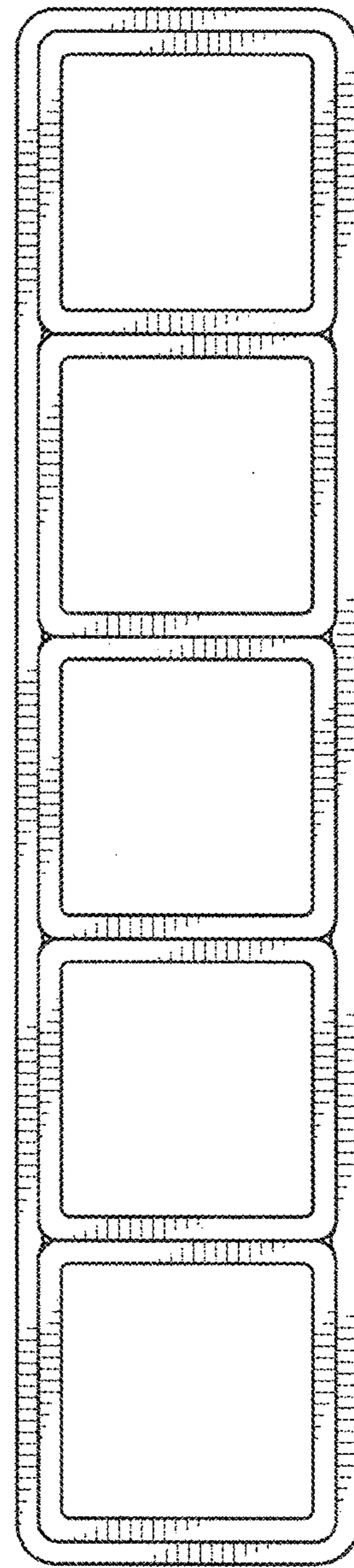

FIG. 7

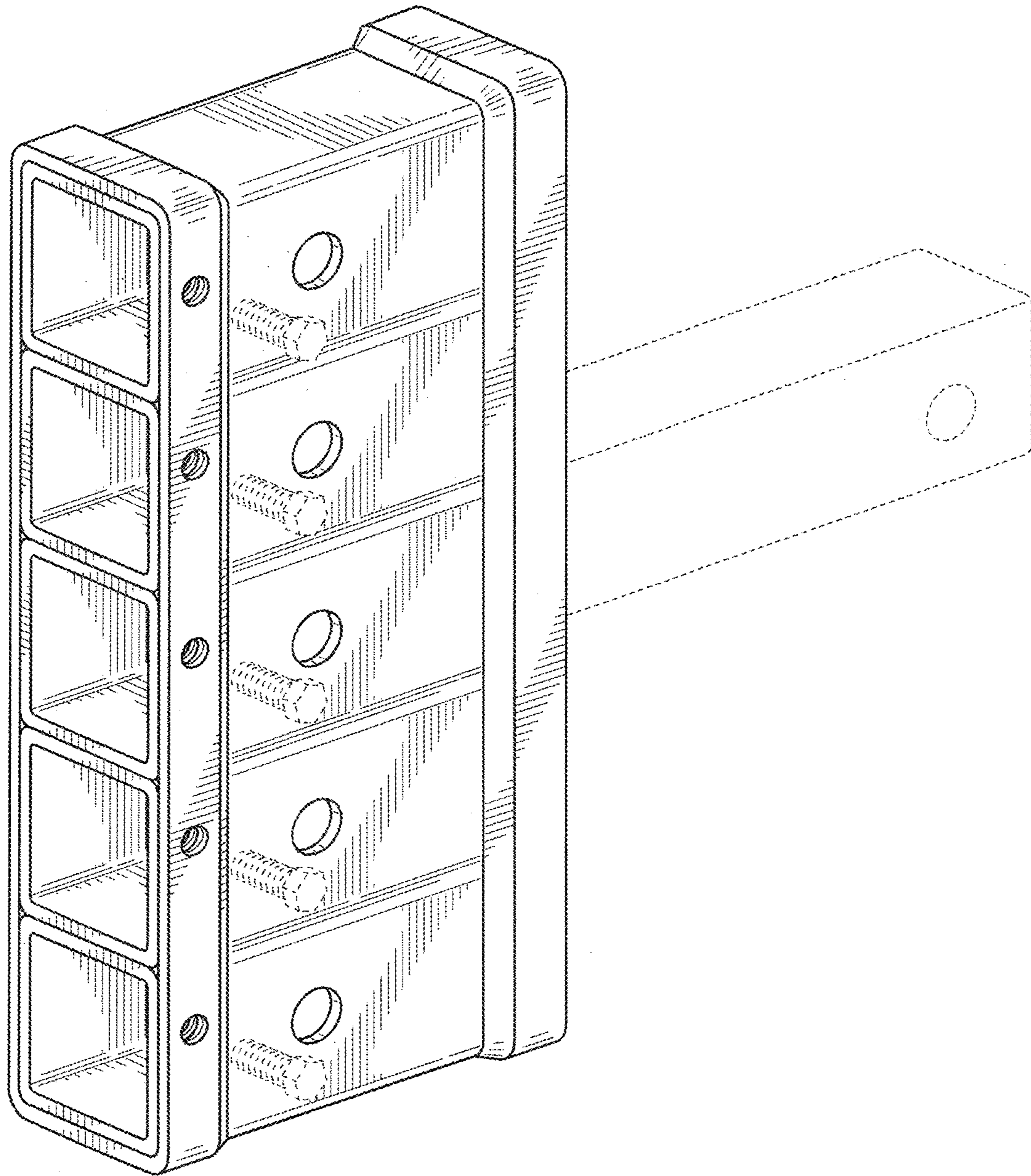

FIG. 8