

US00D922261S

(12) **United States Design Patent** (10) **Patent No.:** **US D922,261 S**
McCuskey (45) **Date of Patent:** **** *Jun. 15, 2021**

(54) **DROP DOWN TRAILER HITCH IV**

D857,565 S * 8/2019 McCuskey D12/162
D862,306 S * 10/2019 Porath B60D 1/605
D12/162
D862,308 S * 10/2019 Siegel D12/162
D873,723 S * 1/2020 Borkholder D12/162
D876,290 S * 2/2020 Kirkland D12/162
D881,078 S * 4/2020 Rebick D12/162
D890,637 S * 7/2020 McCuskey D12/162

(71) Applicant: **Scott McCuskey**, Boardman, OH (US)

(72) Inventor: **Scott McCuskey**, Boardman, OH (US)

(*) Notice: This patent is subject to a terminal disclaimer.

(**) Term: **15 Years**

(21) Appl. No.: **29/699,535**

(22) Filed: **Jul. 26, 2019**

(51) **LOC (13) Cl.** **12-16**

(52) **U.S. Cl.**
USPC **D12/162**

(58) **Field of Classification Search**
USPC D12/159-162
CPC . B60D 1/60; B60D 1/065; B60D 1/00; B60D
1/06; B60D 1/36
See application file for complete search history.

(56) **References Cited**

U.S. PATENT DOCUMENTS

D794,515 S * 8/2017 McCuskey D12/162
D847,697 S * 5/2019 McCuskey D12/162
D851,545 S * 6/2019 McCuskey D12/162
D851,546 S * 6/2019 McCuskey D12/162
D854,970 S * 7/2019 McCuskey D12/162
D857,564 S * 8/2019 McCuskey D12/162

* cited by examiner

Primary Examiner — Katrina A Betton

(74) *Attorney, Agent, or Firm* — Harpman & Harpman

(57) **CLAIM**

The ornamental design for a drop down trailer hitch IV, as shown and described.

DESCRIPTION

FIG. 1 is a front and right side perspective view of a fixed drop down trailer hitch IV showing my new design; FIG. 2 is a right side elevational view thereof; FIG. 3 is a left side elevational view thereof; FIG. 4 is a top plan view thereof; FIG. 5 is a bottom plan view thereof; FIG. 6 is a rear elevational view thereof; FIG. 7 is a front elevational view thereof; and, FIG. 8 is a front and right side perspective view of the fixed drop down trailer hitch IV with related environment in broken lines. The broken lines form no part of the claim and are shown only as relatable environment.

1 Claim, 6 Drawing Sheets

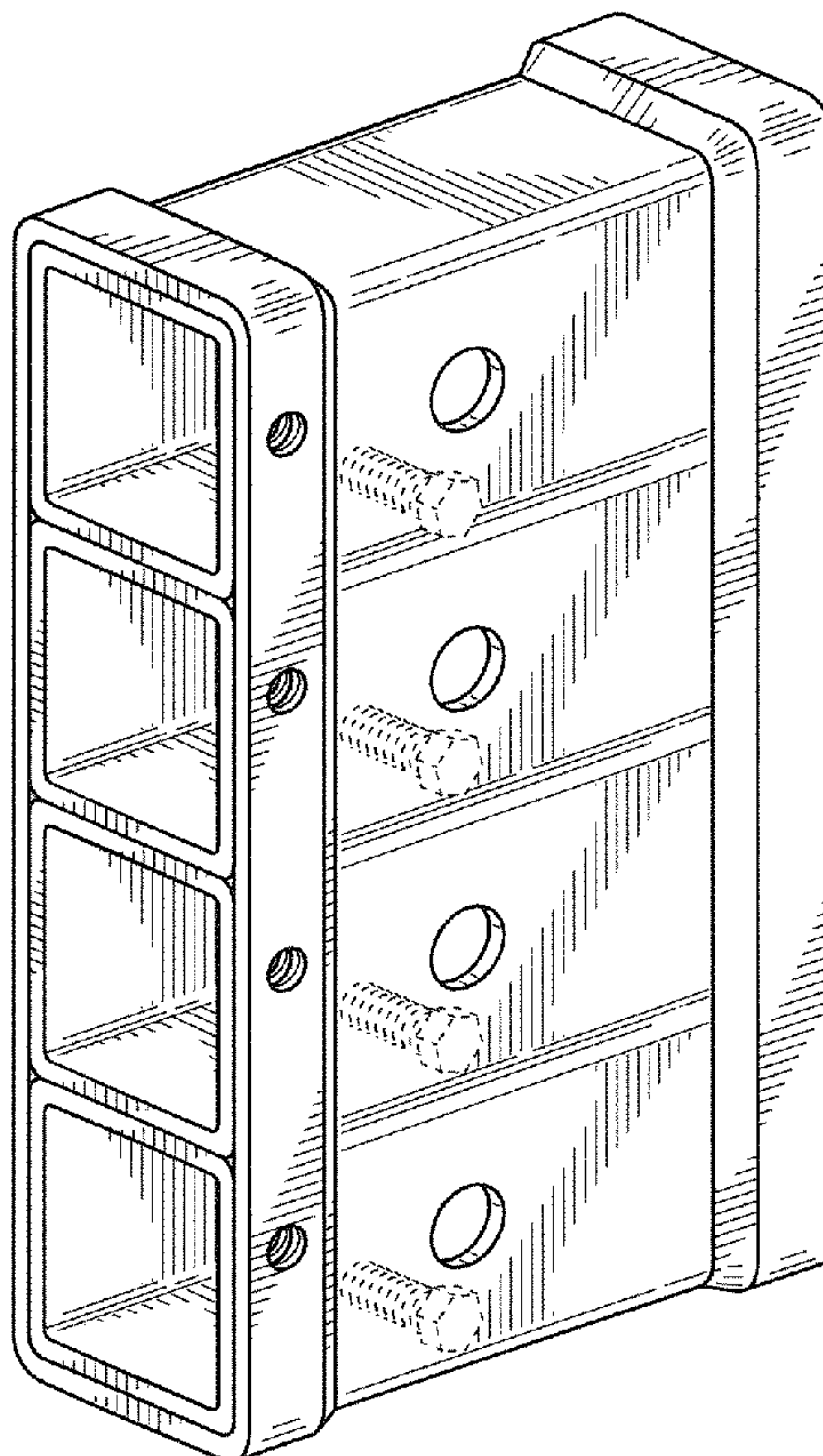

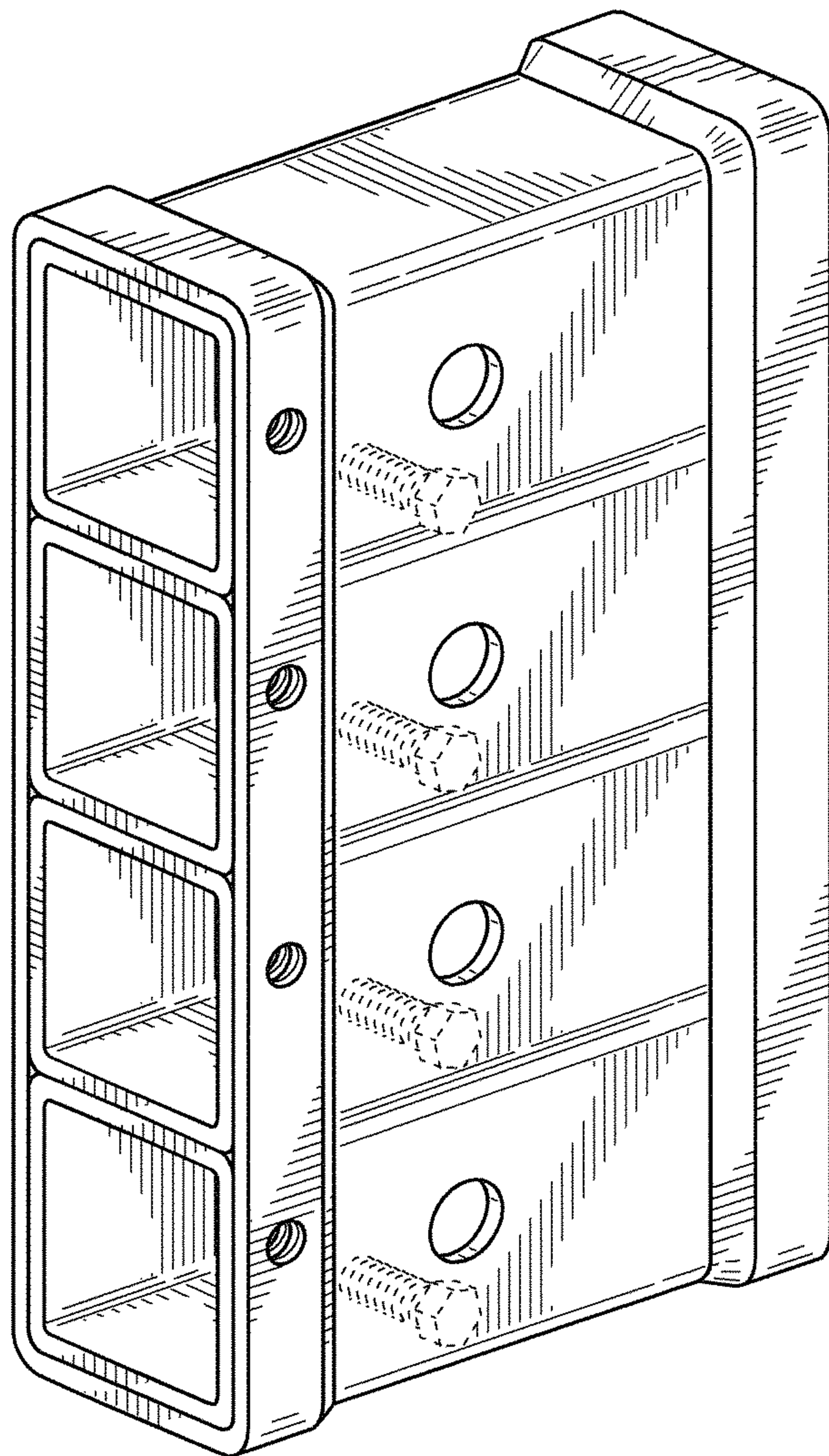

FIG. 1

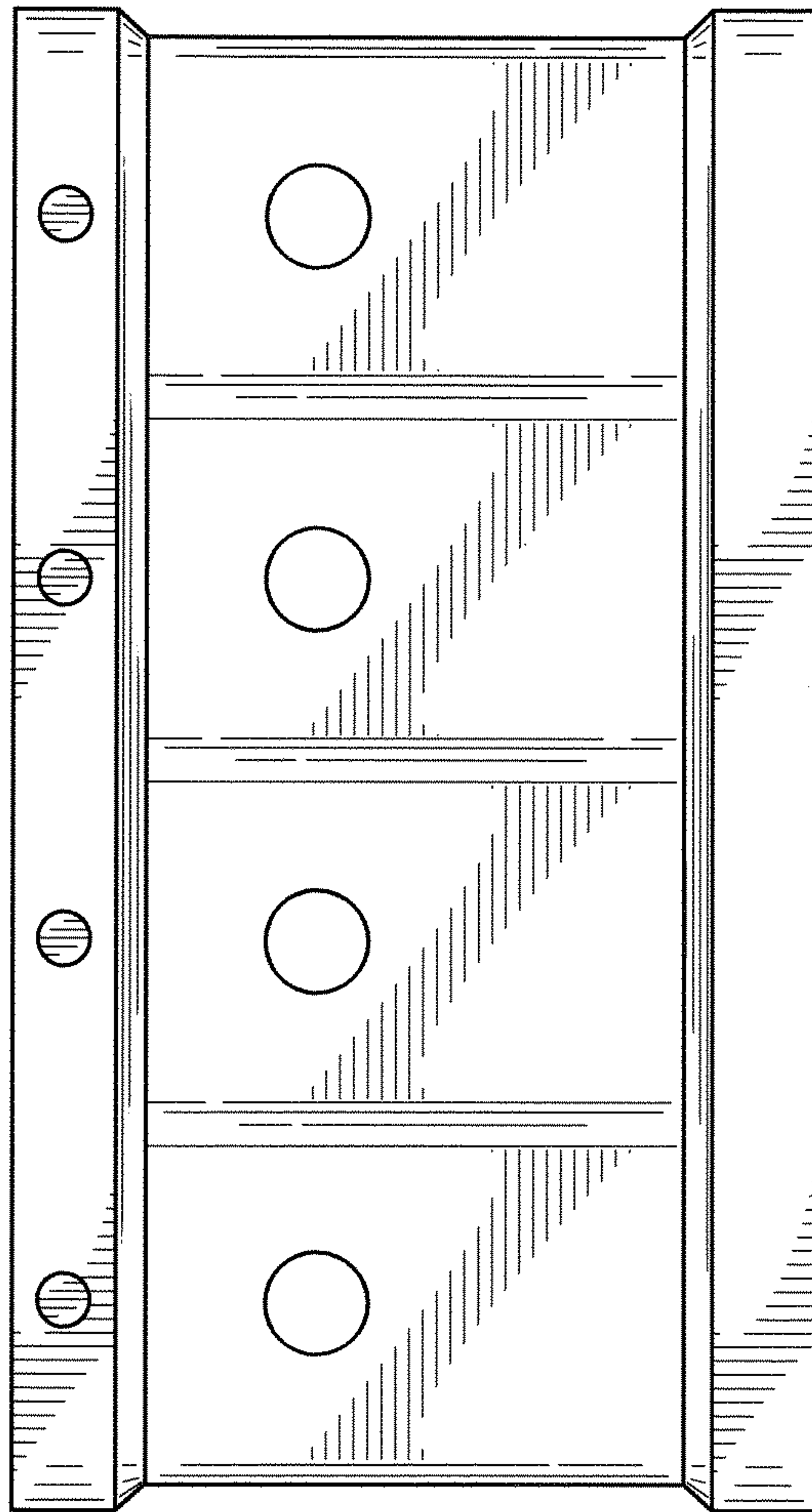

FIG. 2

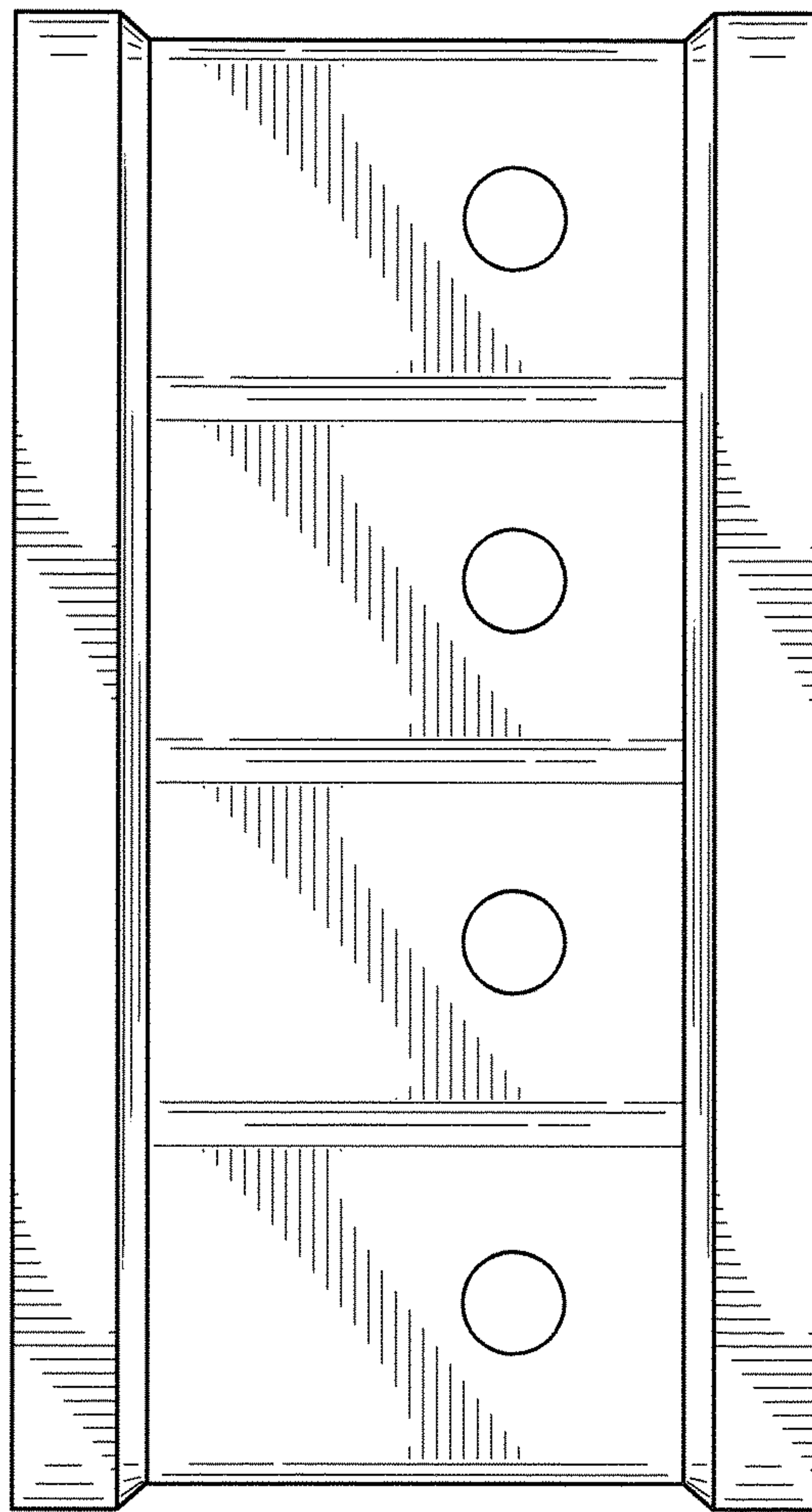

FIG. 3

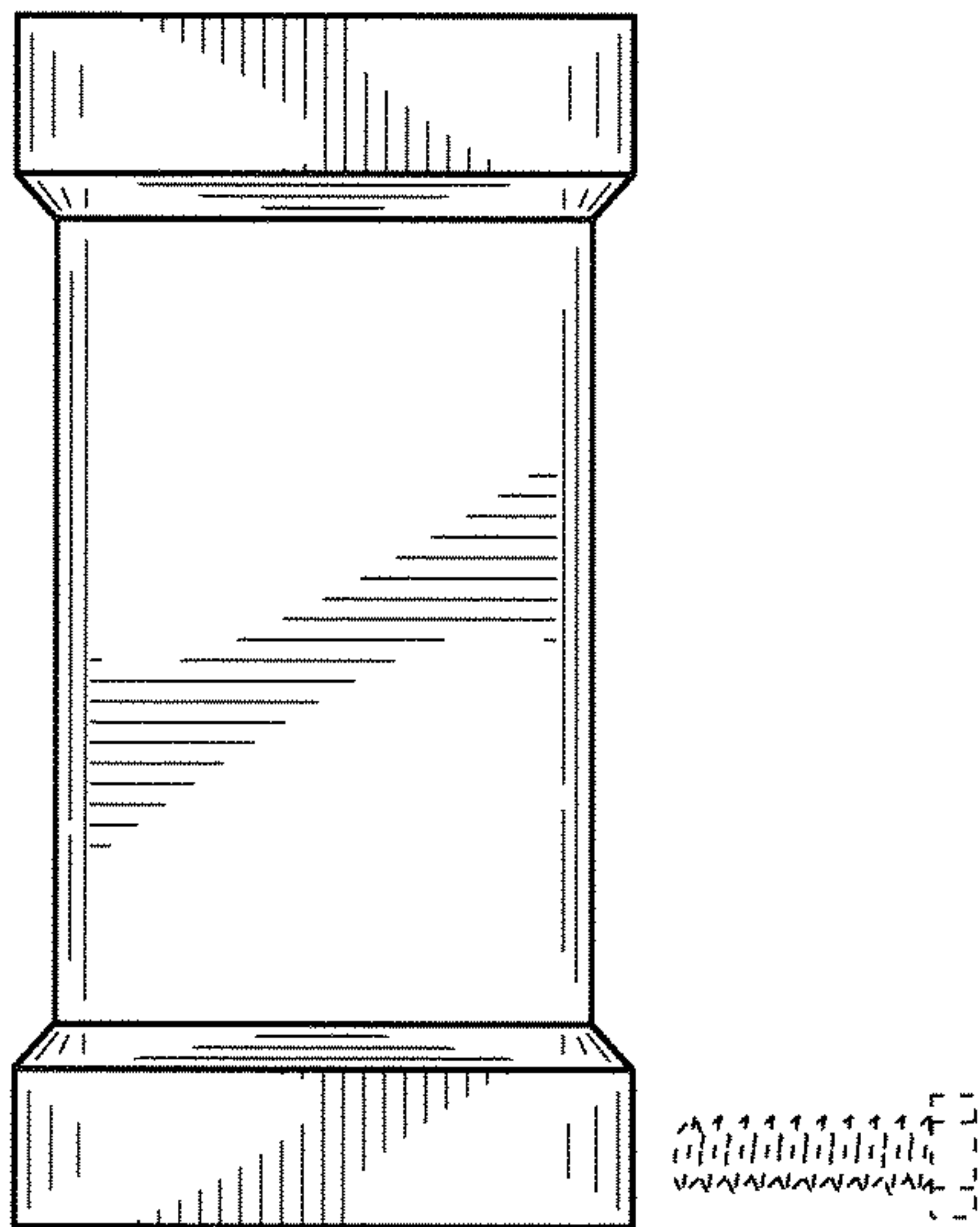

FIG. 4

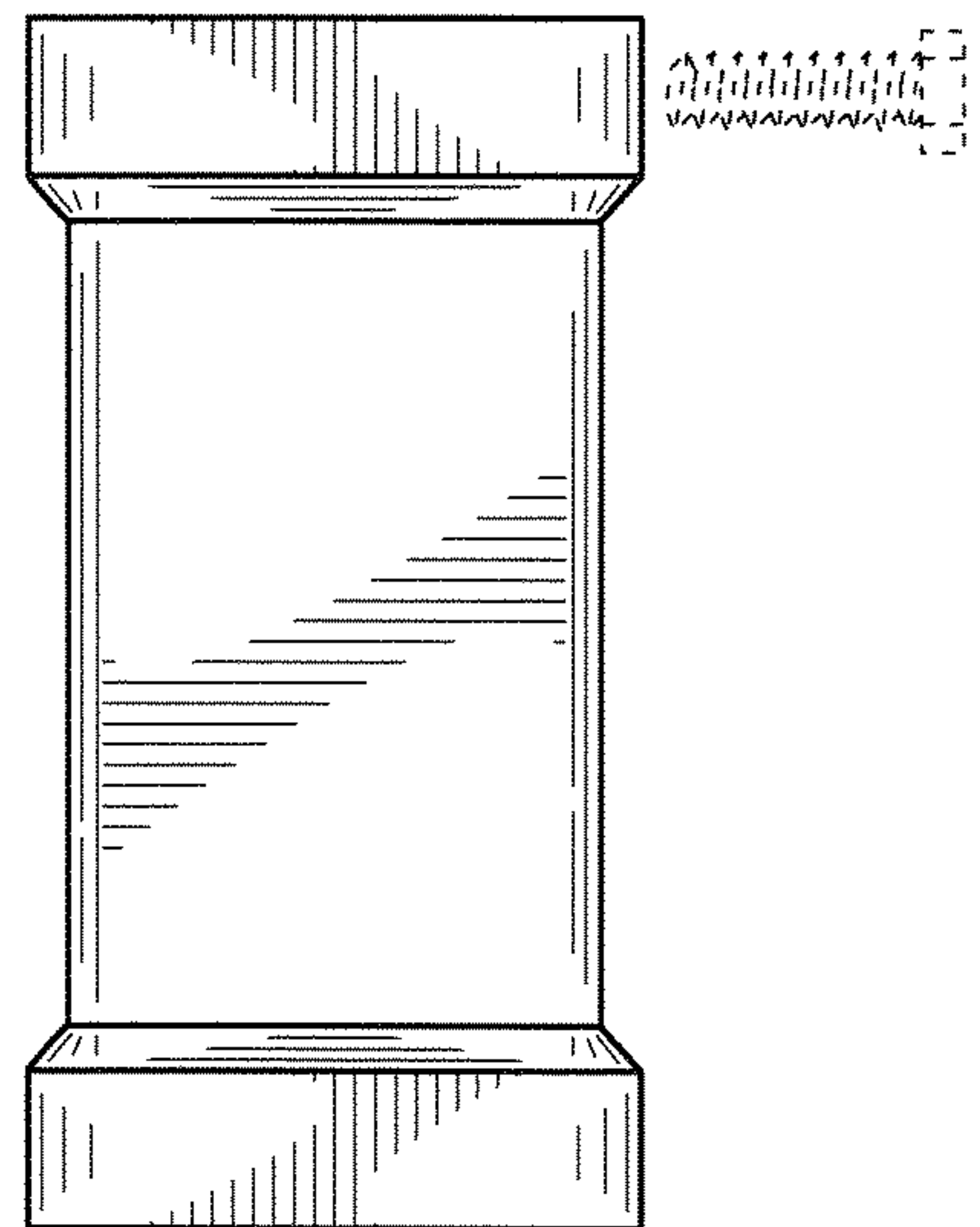

FIG. 5

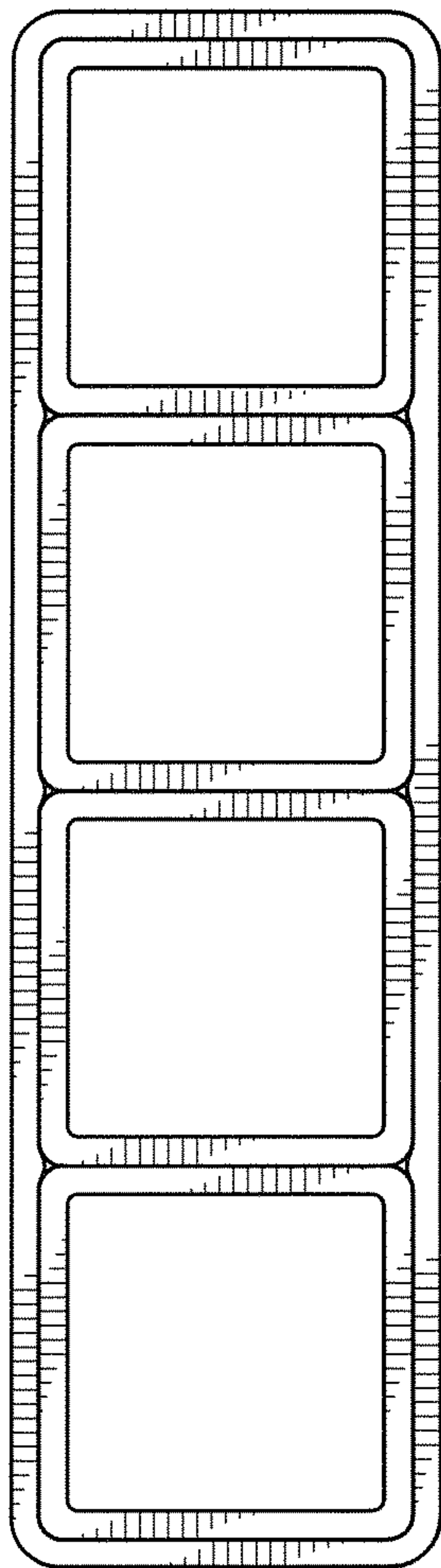

FIG. 6

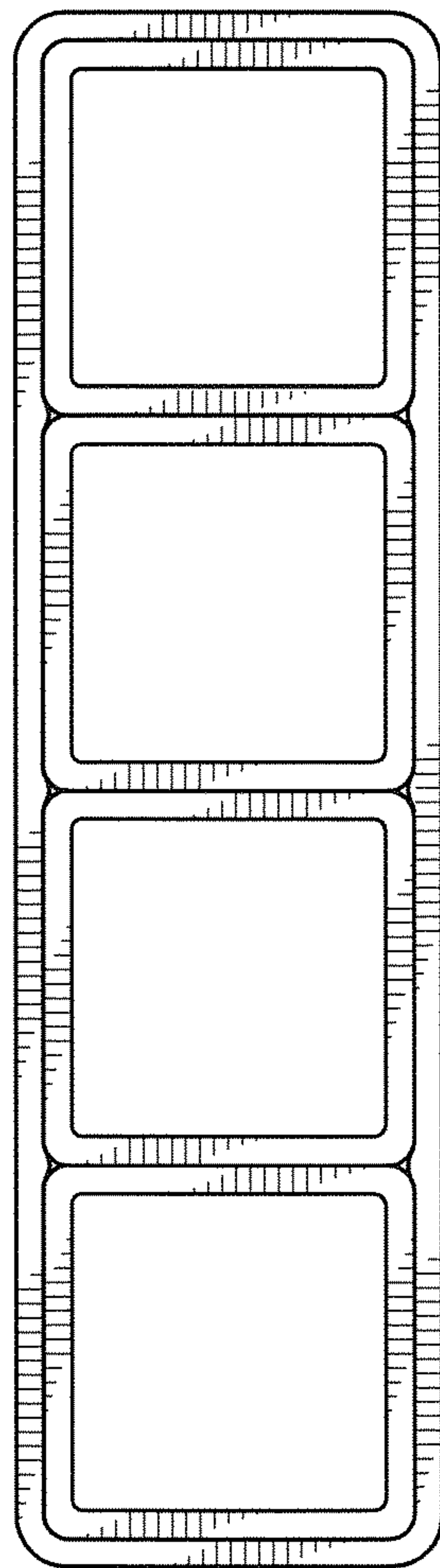
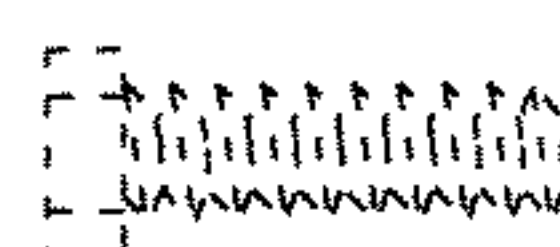
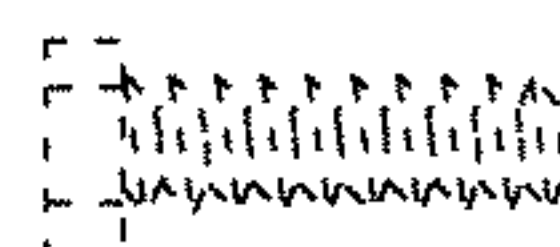
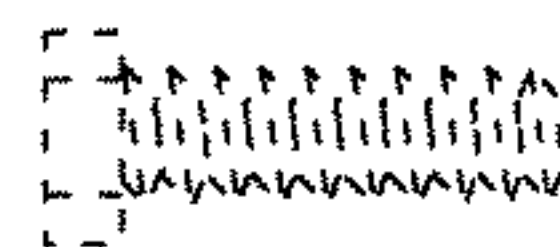
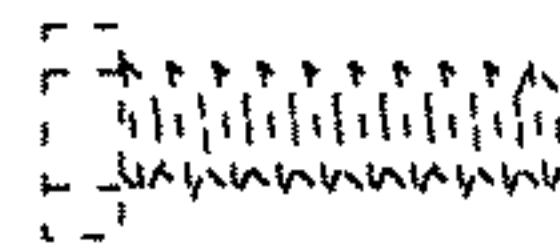
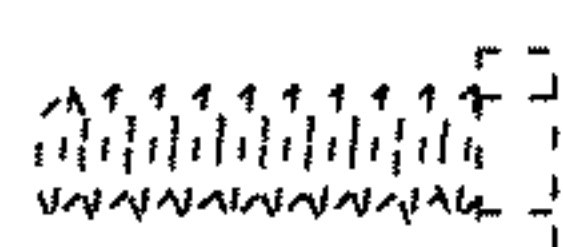
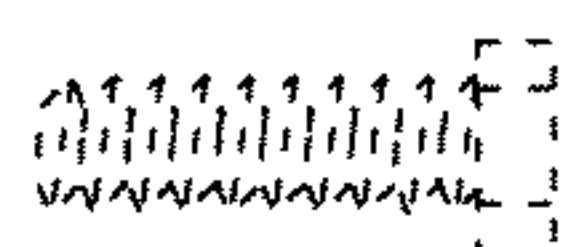
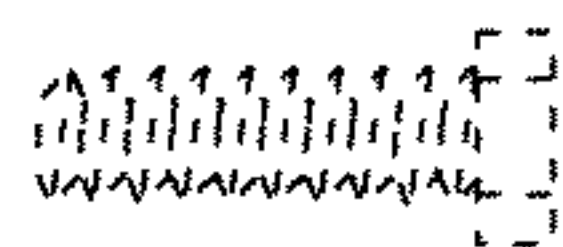
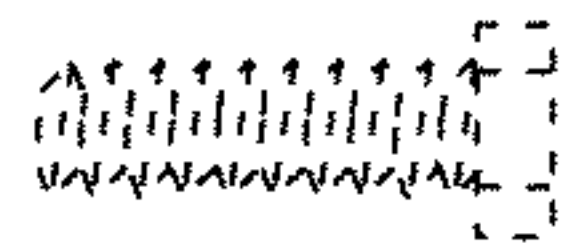

FIG. 7

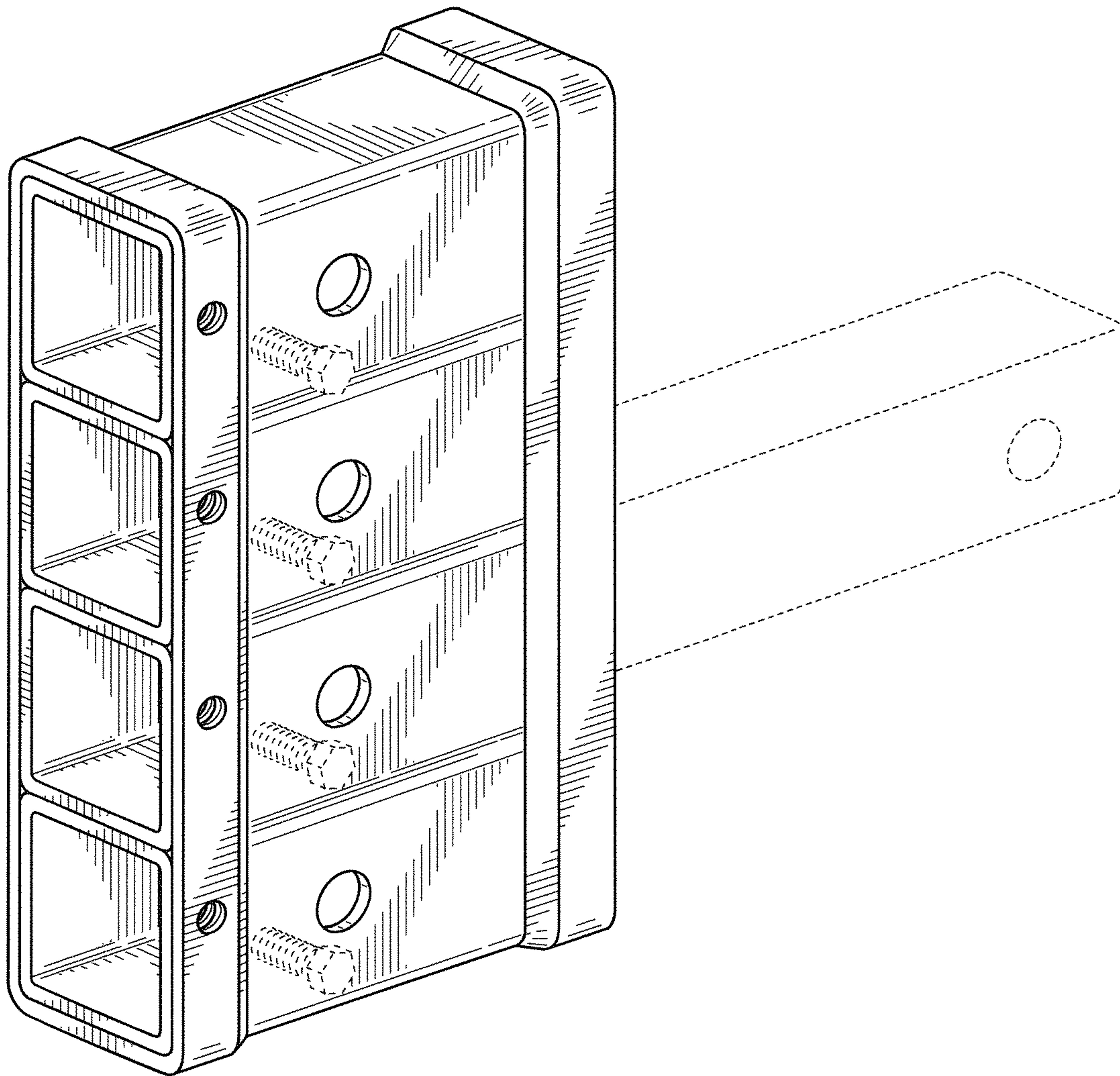

FIG. 8