



US00D922244S

(12) **United States Design Patent** (10) **Patent No.:** **US D922,244 S**
Biancalana et al. (45) **Date of Patent:** **** Jun. 15, 2021**

(54) **DECORATIVE ORNAMENT WITH SURFACE ORNAMENTATION**

- (71) Applicant: **Ferrari S.p.A.**, Modena (IT)
- (72) Inventors: **Matteo Biancalana**, Modena (IT);
Adalberto Cattabriga, Modena (IT);
Luca Zanetti, Modena (IT)
- (73) Assignee: **FERRARI S.p.A.**, Modena (IT)
- (**) Term: **15 Years**
- (21) Appl. No.: **29/756,753**
- (22) Filed: **Oct. 30, 2020**

Related U.S. Application Data

- (62) Division of application No. 35/508,257, filed on Mar. 14, 2019 (U.S. filing date under 35 U.S.C. 384), and
(Continued)

Foreign Application Priority Data

- Sep. 14, 2018 (EM) 005640901
- (51) **LOC (13) Cl.** **11-05**
- (52) **U.S. Cl.**
USPC **D11/125**; D12/86
- (58) **Field of Classification Search**
USPC D12/86, 88, 90-92, 184, 196; D21/424,
D21/433, 434, 533, 548
(Continued)

References Cited

U.S. PATENT DOCUMENTS

- D784,204 S * 4/2017 Abdallah B62D 35/005
D12/92
- D800,020 S * 10/2017 Manzoni D12/91
(Continued)

OTHER PUBLICATIONS

Tuxipuppy-art, Rainbow Car, Deviantart.com, Sep. 2015, retrieved Mar. 18, 2021 from <URL:https://www.deviantart.com/tuxipuppy-art/art/Rainbow-Car-560886630> (Year: 2015).*

(Continued)

Primary Examiner — Sheryl Lane
Assistant Examiner — Calvin E Vansant

(74) *Attorney, Agent, or Firm* — Cowan, Liebowitz & Latman, P.C.; Anastasia Zhadina

(57) **CLAIM**

The ornamental design for a decorative ornament with surface ornamentation, as shown and described.

DESCRIPTION

The patent or application file contains at least one drawing executed in color. Copies of this patent or patent application publication with color drawing(s) will be provided by the Office upon request and payment of the necessary fee.

FIG. 1 is a front perspective view of a first embodiment of the decorative ornament with surface ornamentation showing our design;

FIG. 2 is a rear perspective view thereof;

FIG. 3 is a front view thereof;

FIG. 4 is a rear view thereof;

FIG. 5 is a right-side view thereof;

FIG. 6 is a top plan view thereof;

FIG. 7 is a bottom view thereof;

FIG. 8 is a front perspective view of a second embodiment of the decorative ornament with surface ornamentation showing my design;

FIG. 9 is a rear perspective view thereof;

FIG. 10 is a front view thereof;

FIG. 11 is a rear view thereof;

FIG. 12 is a right-side view thereof;

FIG. 13 is a top plan view thereof; and,

FIG. 14 is a bottom view thereof.

1 Claim, 14 Drawing Sheets
(7 of 14 Drawing Sheet(s) Filed in Color)

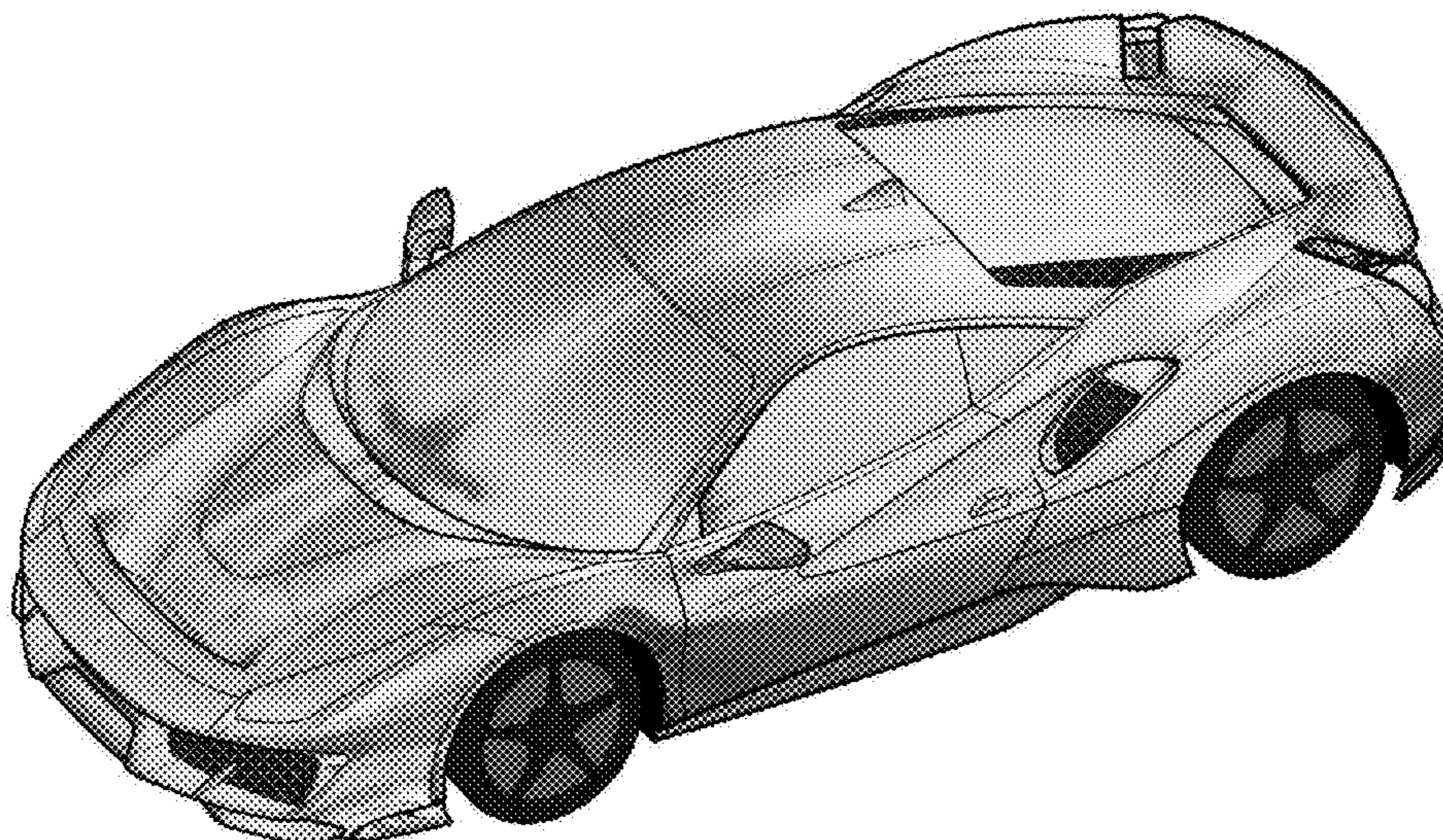

Related U.S. Application Data

having an international filing date of Mar. 14, 2019,
now Pat. No. Des. 904,926.

(58) **Field of Classification Search**

CPC B62D 25/00; B62D 25/02; B62D 25/06;
B62D 35/00; B62D 35/005; B60J 5/04
See application file for complete search history.

(56) **References Cited**

U.S. PATENT DOCUMENTS

D801,227 S * 10/2017 Stephenson D12/88
D801,871 S * 11/2017 Manzoni D12/92
D813,095 S * 3/2018 Manzoni D12/88
D817,814 S * 5/2018 Nurnberger D12/88
D823,724 S * 7/2018 Melville D12/92
D830,901 S * 10/2018 Manzoni D12/88
D830,902 S * 10/2018 Manzoni D12/88
D856,194 S * 8/2019 Saleen D12/92
D863,104 S * 10/2019 Bennion D12/88
D870,823 S * 12/2019 Manzoni D21/548
2019/0233022 A1 * 8/2019 Biancalana B62D 35/005

OTHER PUBLICATIONS

Youtube.com, Camaro ZL1 Heat Map, Apr. 2017, video still retrieved
Mar. 18, 2021 from <URL:https://youtu.be/Qw6JZIGYPos?t=8>
(Year: 2017).*

* cited by examiner

FIG. 1

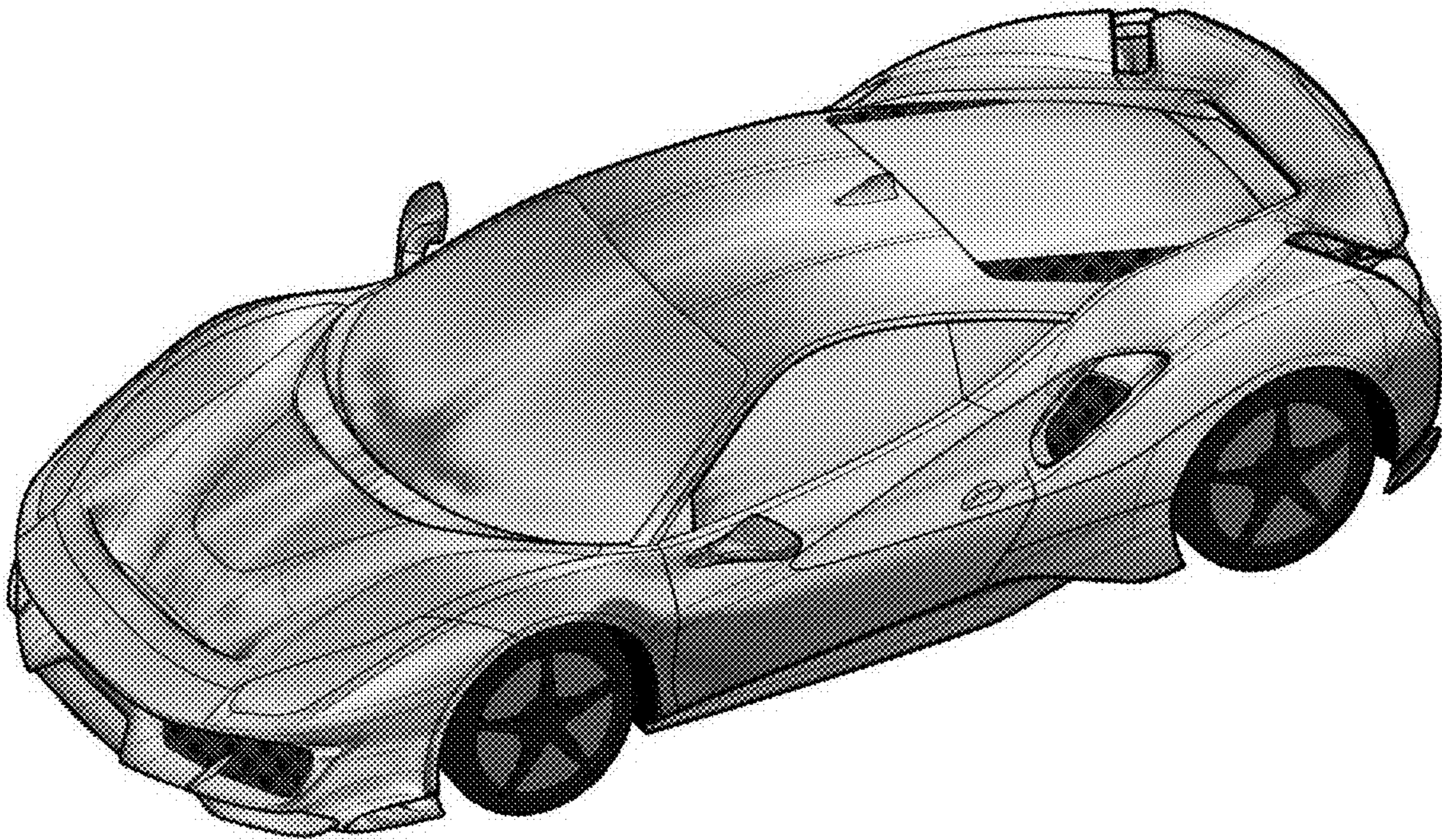

FIG. 2

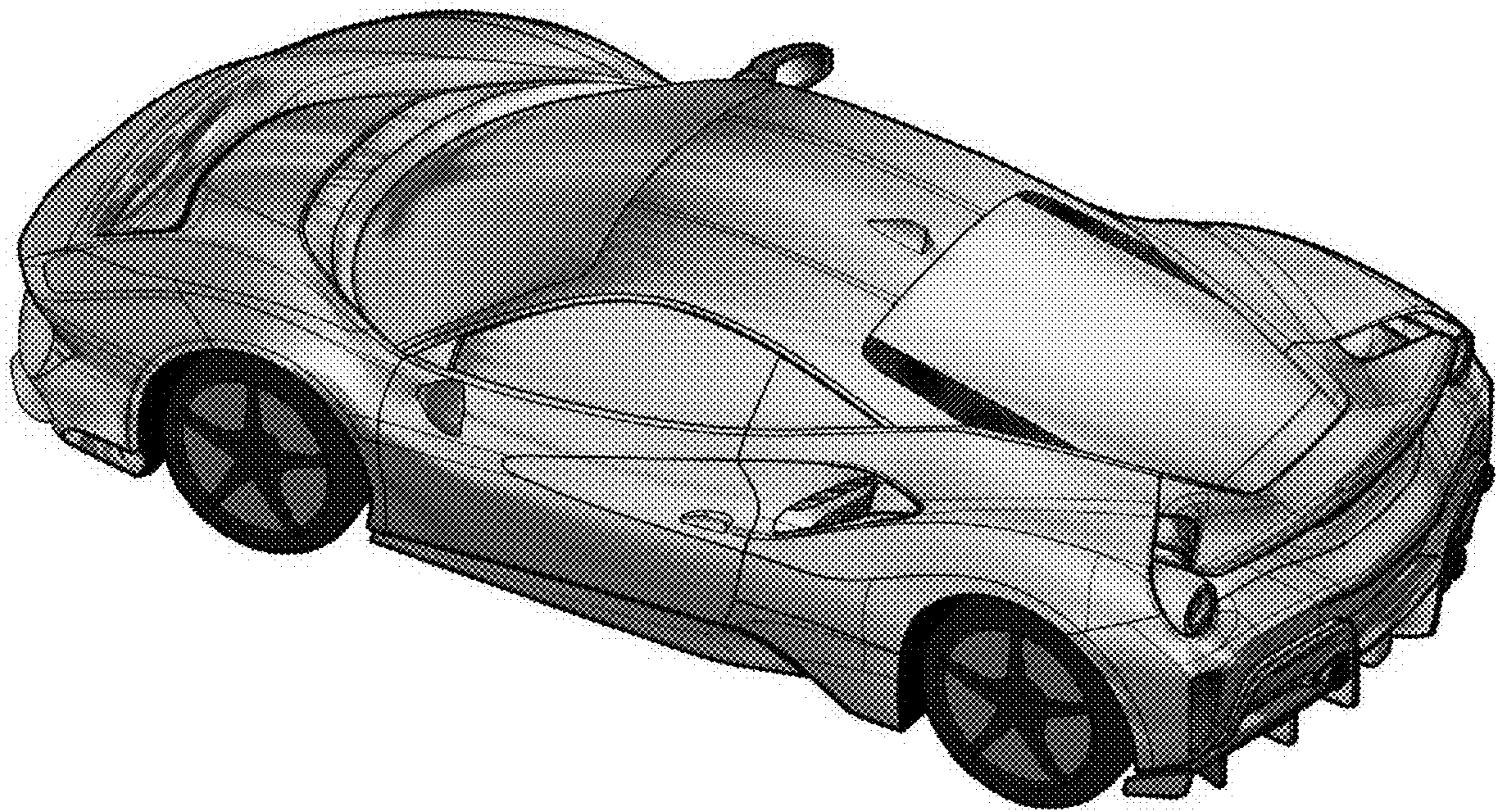

FIG. 3

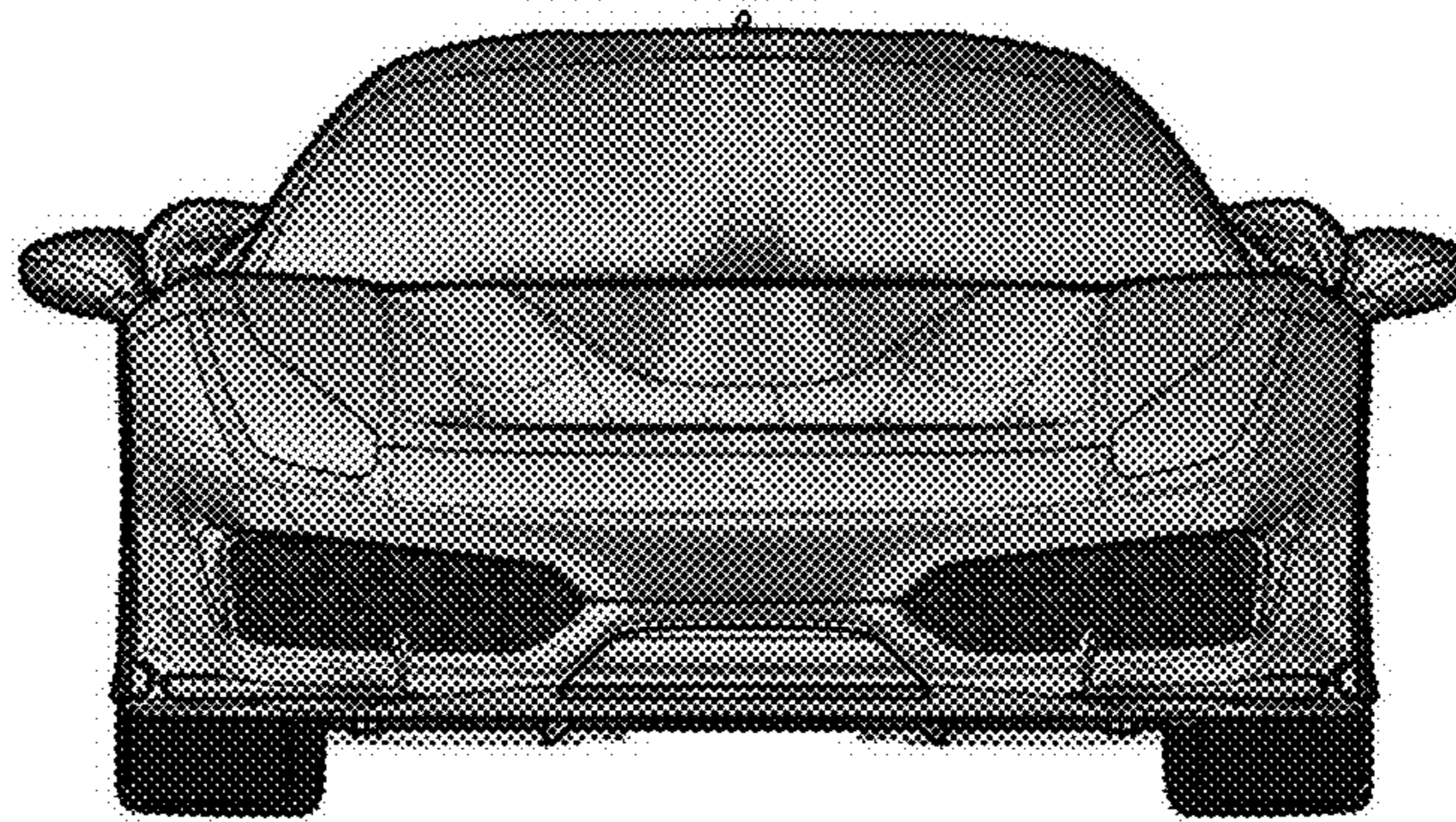

FIG. 4

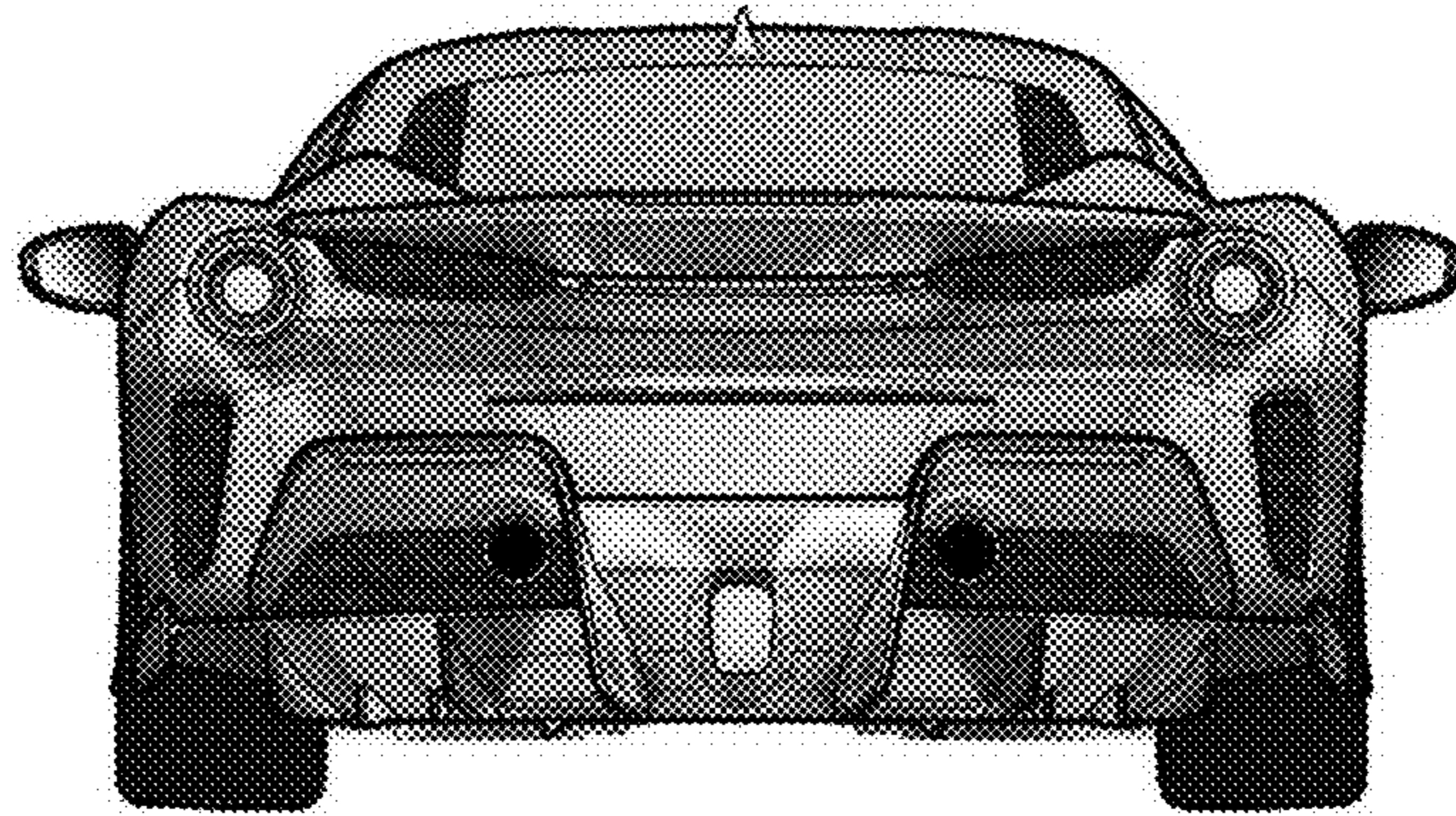

FIG. 5

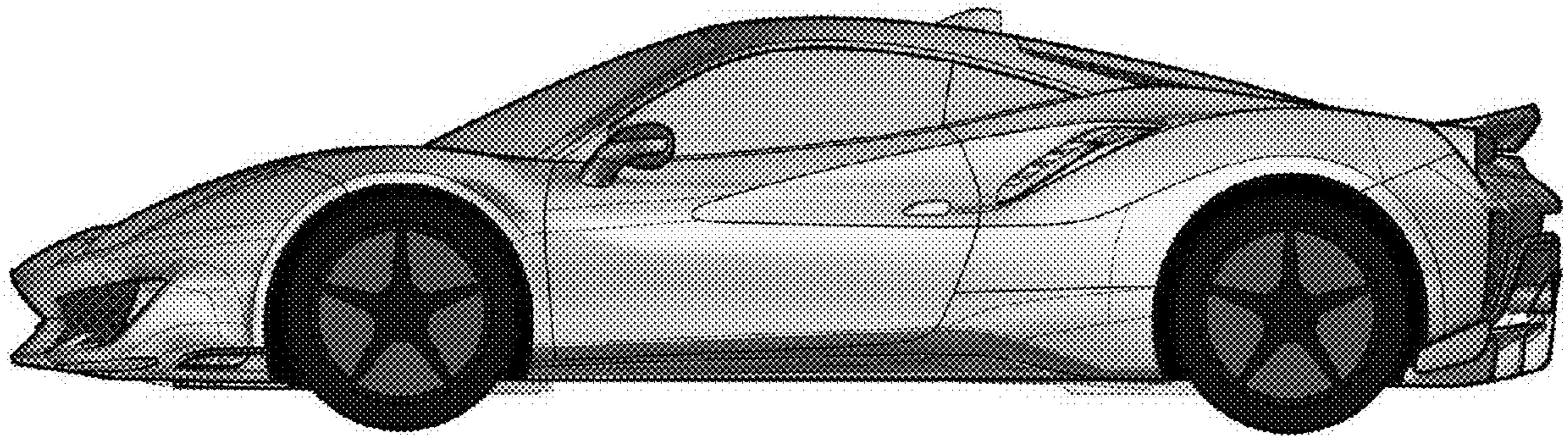

FIG. 6

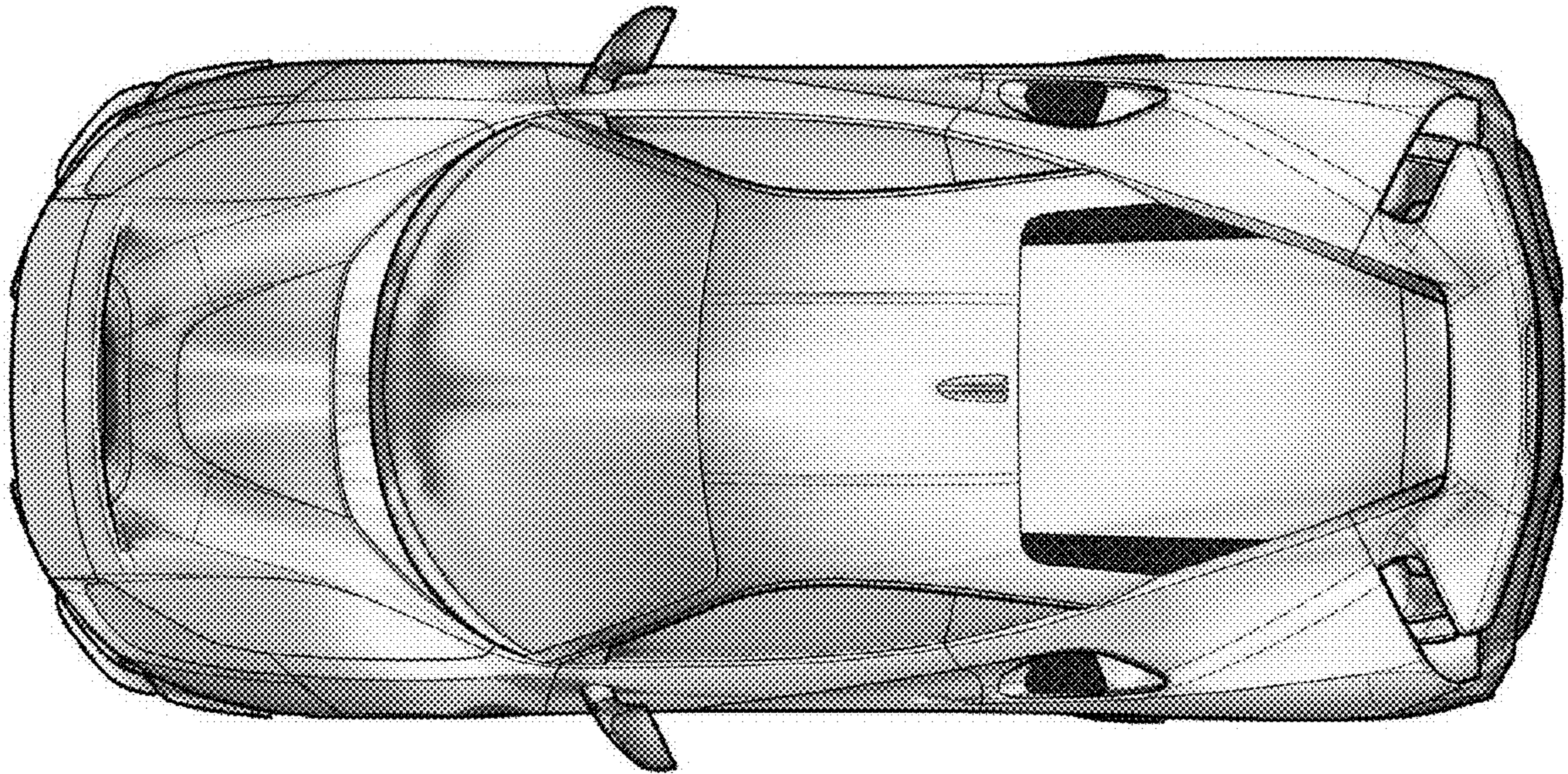

FIG. 7

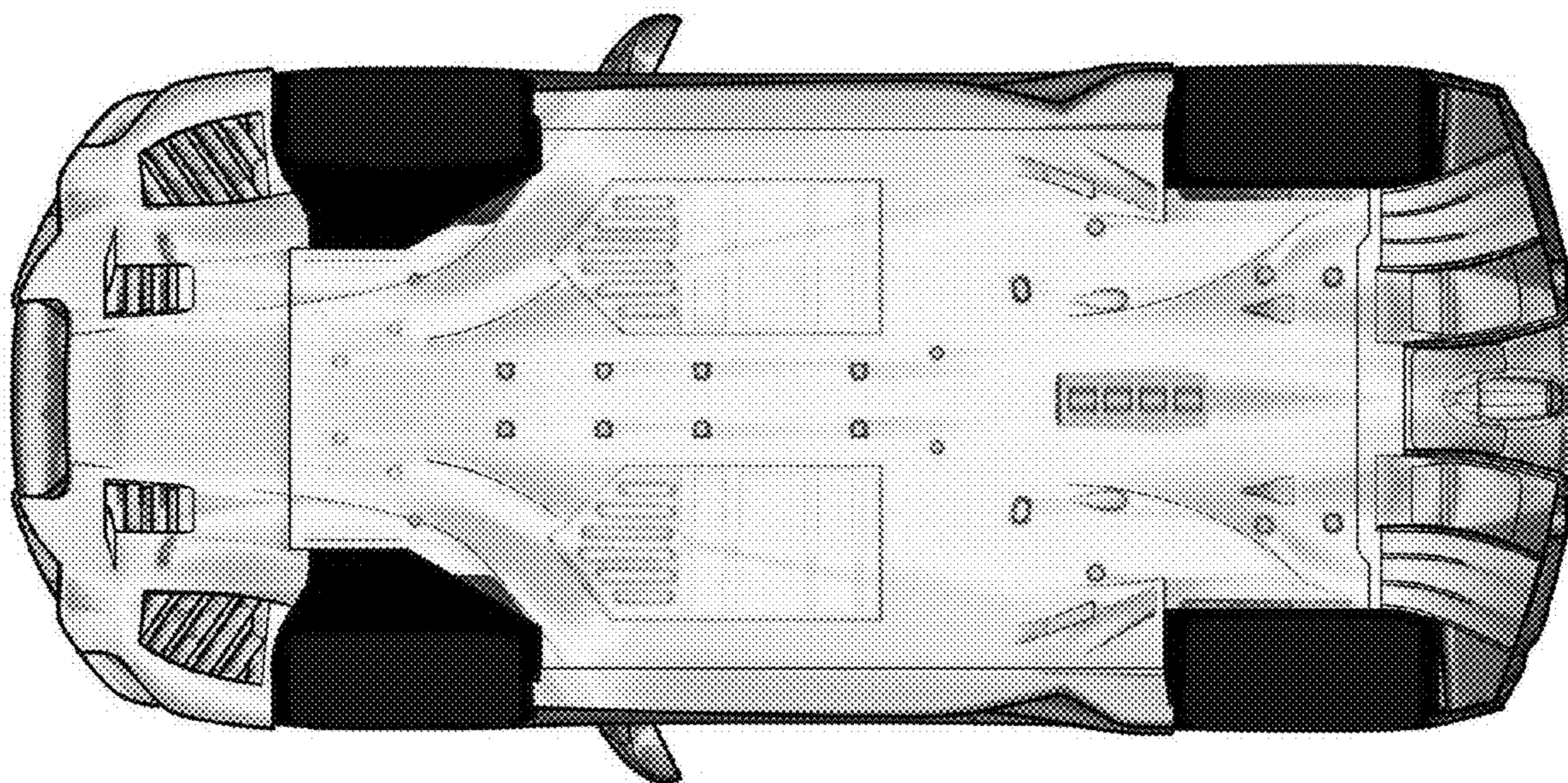

FIG. 8

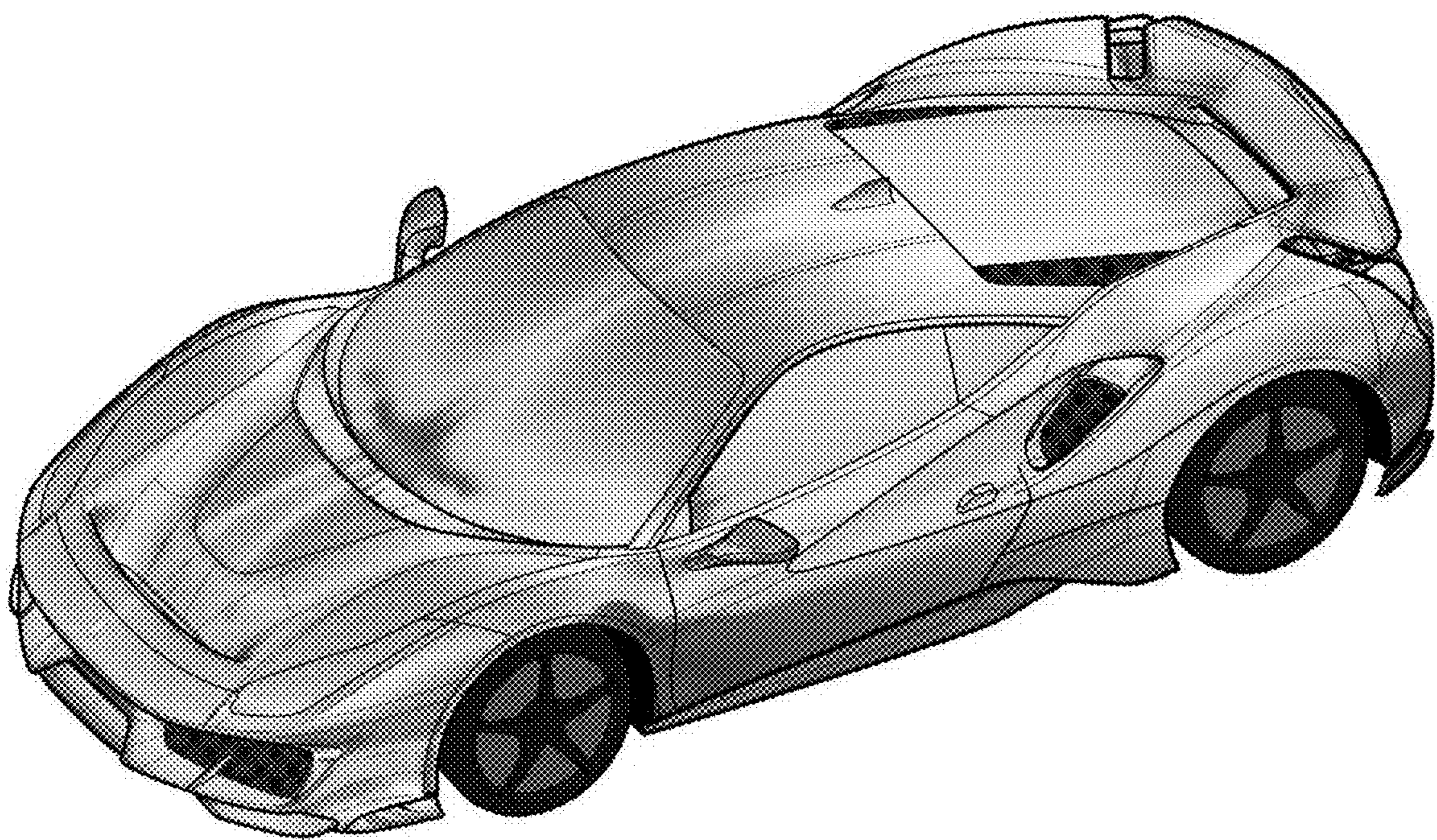

FIG. 9

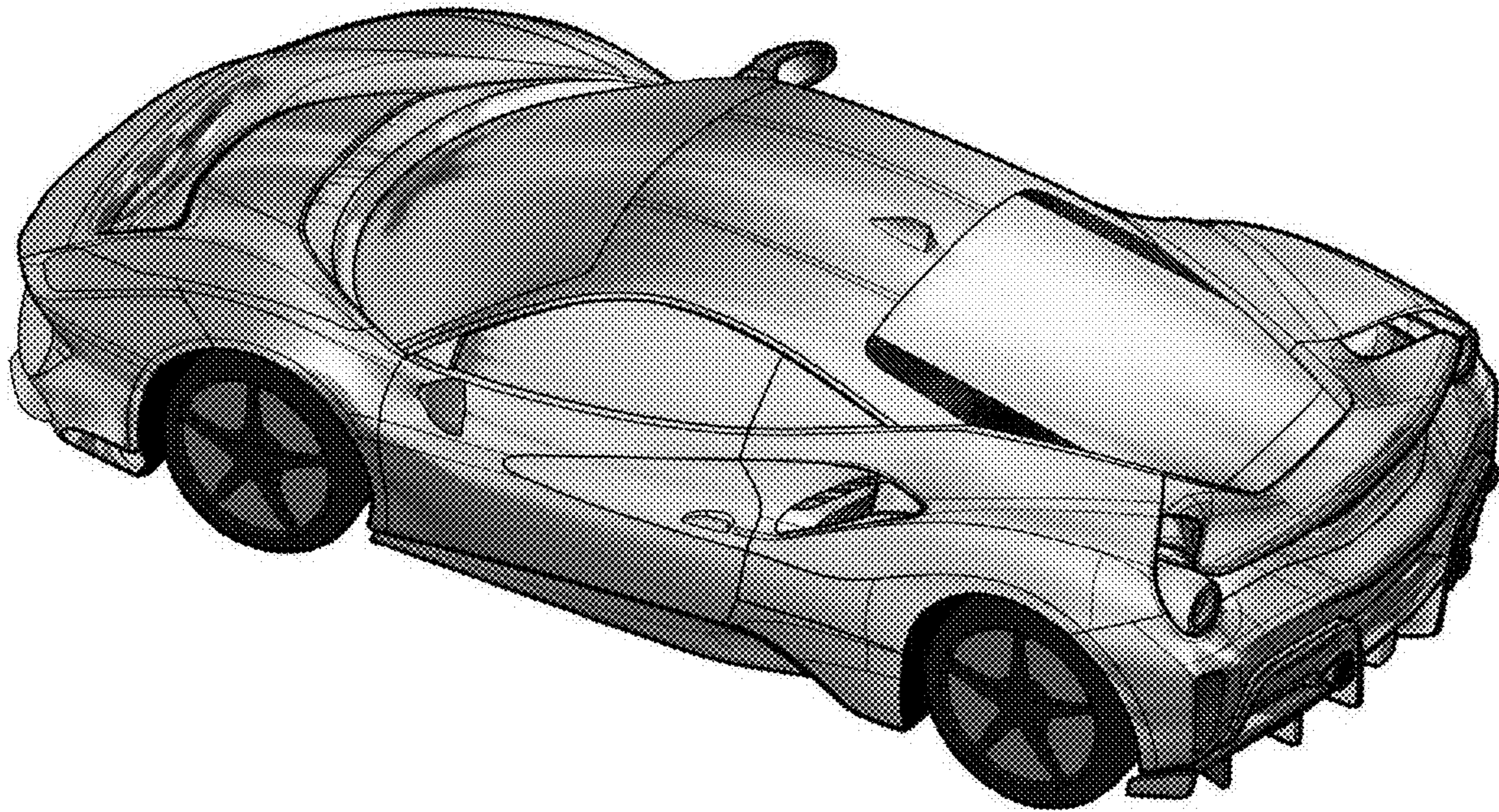

FIG. 10

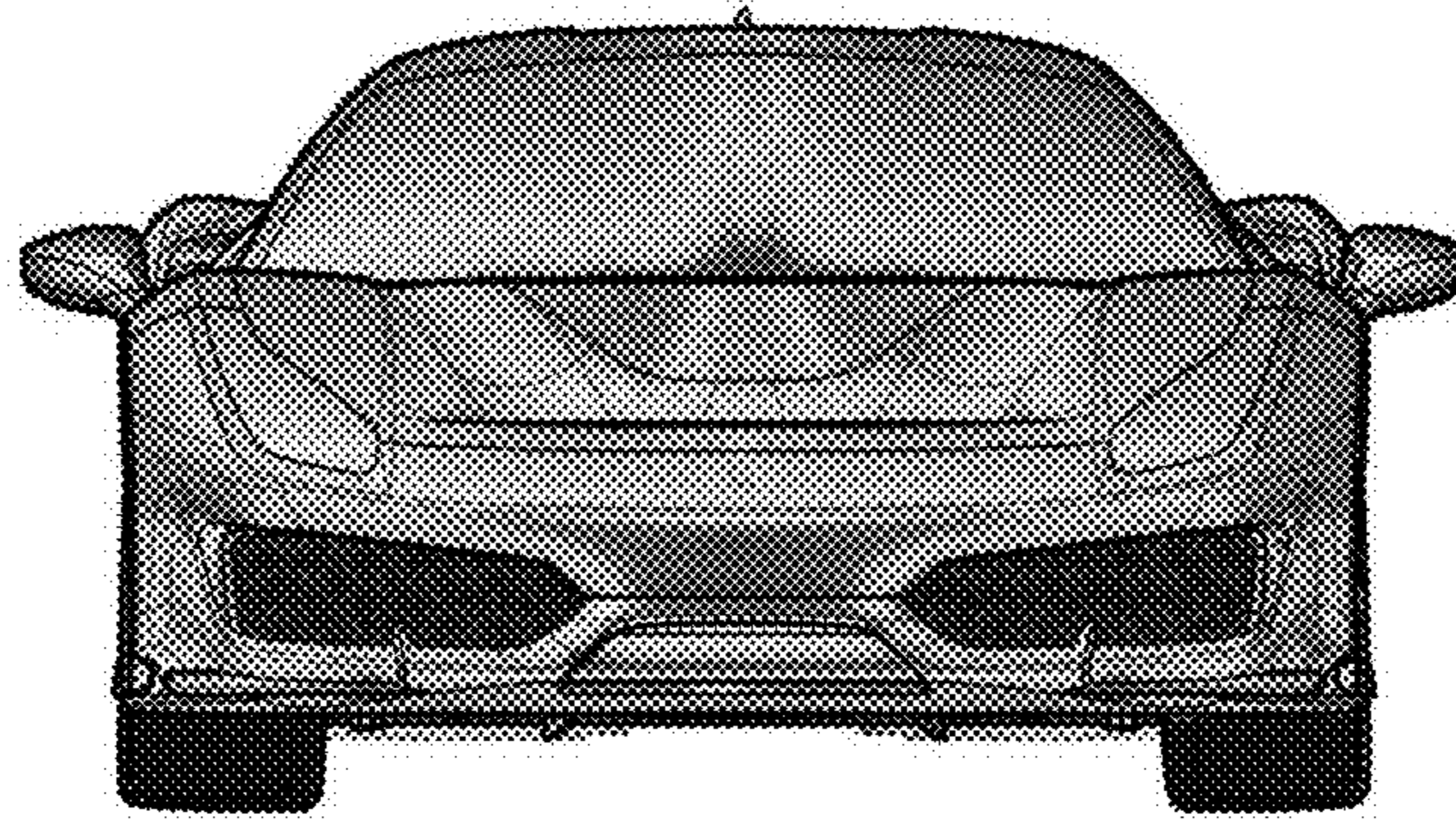

FIG. 11

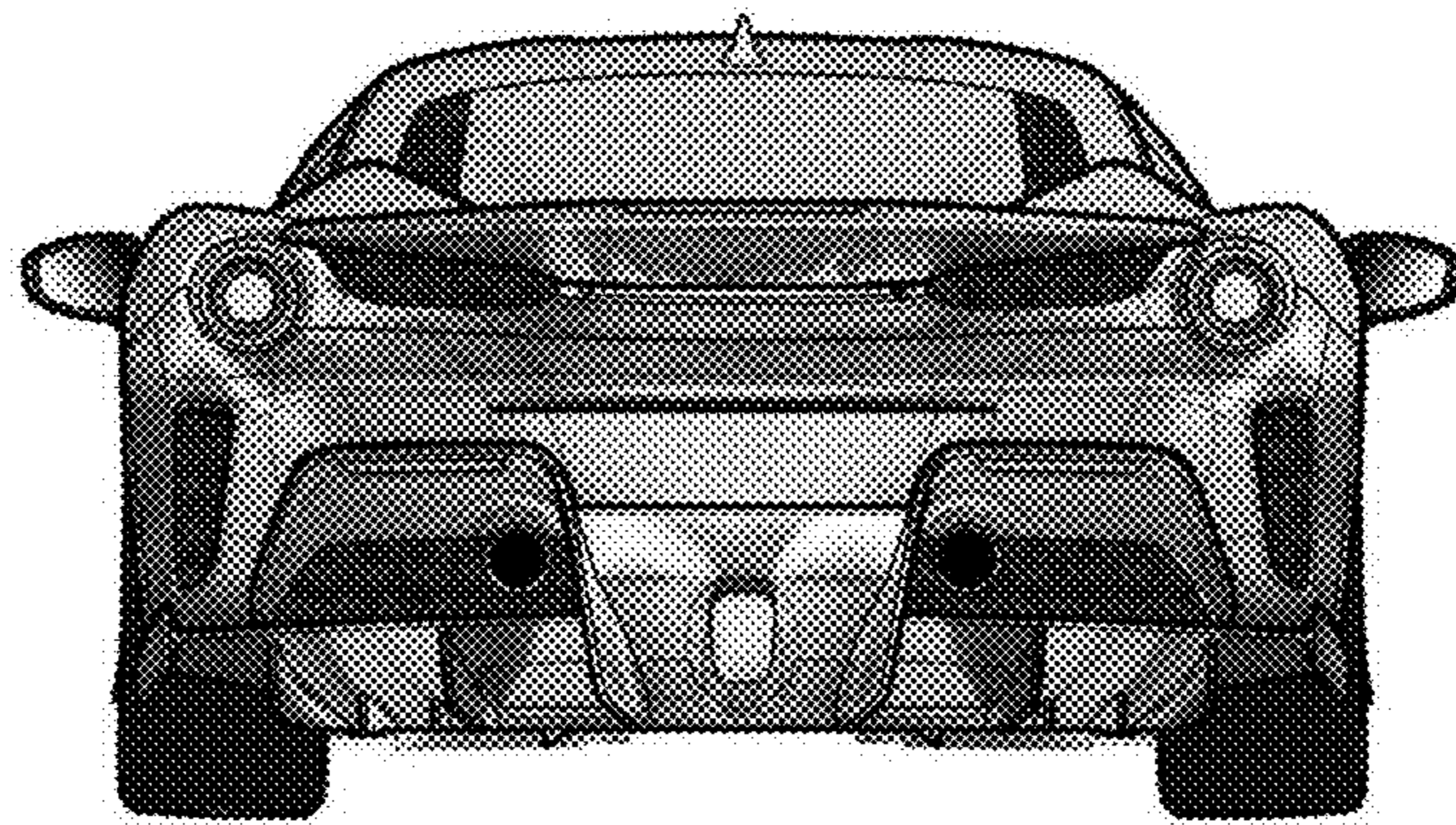

FIG. 12

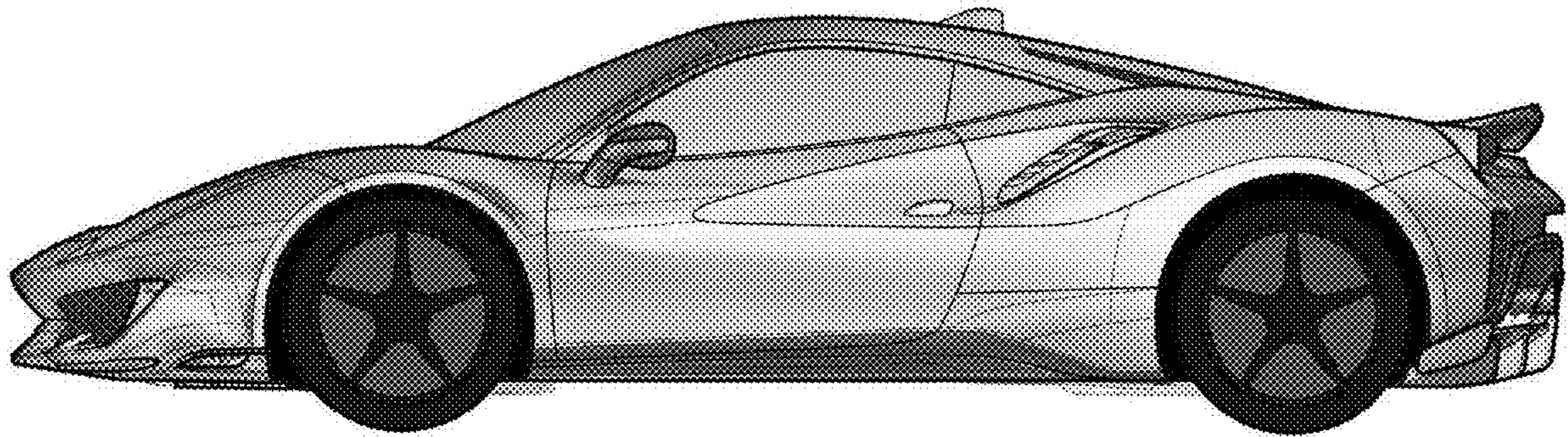

FIG. 13

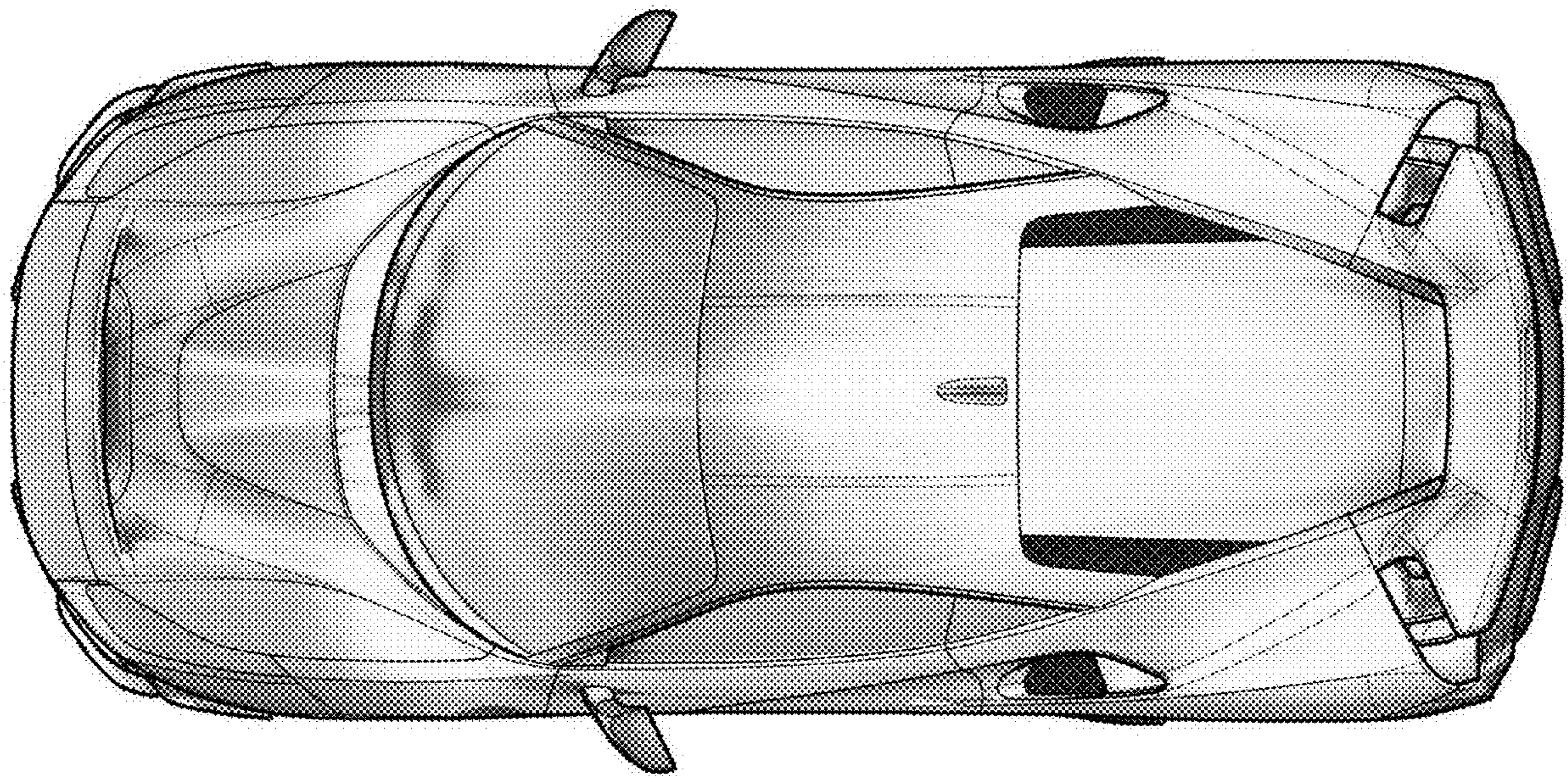

FIG. 14

