



US00D922163S

(12) **United States Design Patent**  
**Roberts et al.**

(10) **Patent No.:** **US D922,163 S**  
(45) **Date of Patent:** **\*\* Jun. 15, 2021**

(54) **PRUNER**

(71) Applicant: **Fiskars Finland Oy Ab**, Helsinki (FI)

(72) Inventors: **Colin Roberts**, Helsinki (FI); **Brian Rojas-Edge**, Helsinki (FI)

(73) Assignee: **FISKARS FINLAND OY AB**, Helsinki (FI)

(\*\*) Term: **15 Years**

(21) Appl. No.: **29/710,923**

(22) Filed: **Oct. 28, 2019**

(51) **LOC (13) Cl.** ..... **08-03**

(52) **U.S. Cl.**  
USPC ..... **D8/5**

(58) **Field of Classification Search**  
USPC ..... D8/4, 5, 7, 51, 52, 57  
CPC ..... A01G 2003/005; A01G 2/35; A01G 3/02;  
A01G 3/065; A01G 3/021; A01G  
2003/023; B26B 13/26; B26B 13/28;  
B26B 13/285; B26B 13/16; B25B 7/14  
See application file for complete search history.

D426,755 S 6/2000 Wu  
D457,040 S 5/2002 Hirschfeld  
D457,401 S \* 5/2002 Clivio ..... D8/5  
D458,094 S 6/2002 Clivio  
D458,815 S 6/2002 Meyerratken  
D458,816 S 6/2002 Meyerratken  
6,418,626 B1 \* 7/2002 Jang ..... A01G 3/02  
30/254

D463,227 S 9/2002 Choi  
D472,433 S 4/2003 Richwine  
D496,838 S 10/2004 Tomchak  
D499,316 S \* 12/2004 Tatic ..... D8/5  
D499,317 S \* 12/2004 Tatic ..... D8/5  
D500,236 S \* 12/2004 Albert ..... D8/5

(Continued)

*Primary Examiner* — Sandra Snapp  
*Assistant Examiner* — Ieisha N Price  
(74) *Attorney, Agent, or Firm* — Leason Ellis LLP

(57) **CLAIM**

The ornamental design for a pruner, as shown and described.

**DESCRIPTION**

FIG. 1 is a top plan view of our pruner according to our new design;  
FIG. 2 is a left, side view thereof;  
FIG. 3 is a right, side view thereof;  
FIG. 4 is a bottom-left rear perspective view thereof;  
FIG. 5 is a bottom-left front perspective view thereof;  
FIG. 6 is a top-left rear perspective view thereof;  
FIG. 7 is a top-left front perspective view thereof;  
FIG. 8 is a front view thereof;  
FIG. 9 is a bottom plan view thereof; and,  
FIG. 10 is a rear view thereof.  
The broken lines in the drawings illustrate portions of the pruner and form no part of the claimed design.  
Conventional shading is illustrated for purposes of highlighting the line drawings, but forms no part of the claimed design.

(56) **References Cited**

U.S. PATENT DOCUMENTS

4,073,059 A 2/1978 Wallace et al.  
4,079,513 A 3/1978 Harrison  
4,268,963 A 5/1981 Harrison  
4,341,016 A 7/1982 Harrison et al.  
5,058,277 A 10/1991 Kishimoto  
D336,412 S 6/1993 Wensley  
D337,033 S \* 7/1993 DeVille ..... D8/5  
5,367,774 A 11/1994 Labarre et al.  
5,426,857 A 6/1995 Linden  
D377,588 S 1/1997 Birkholz  
5,697,159 A \* 12/1997 Linden ..... A01G 3/02  
30/192

D396,615 S 8/1998 Spear

**1 Claim, 10 Drawing Sheets**

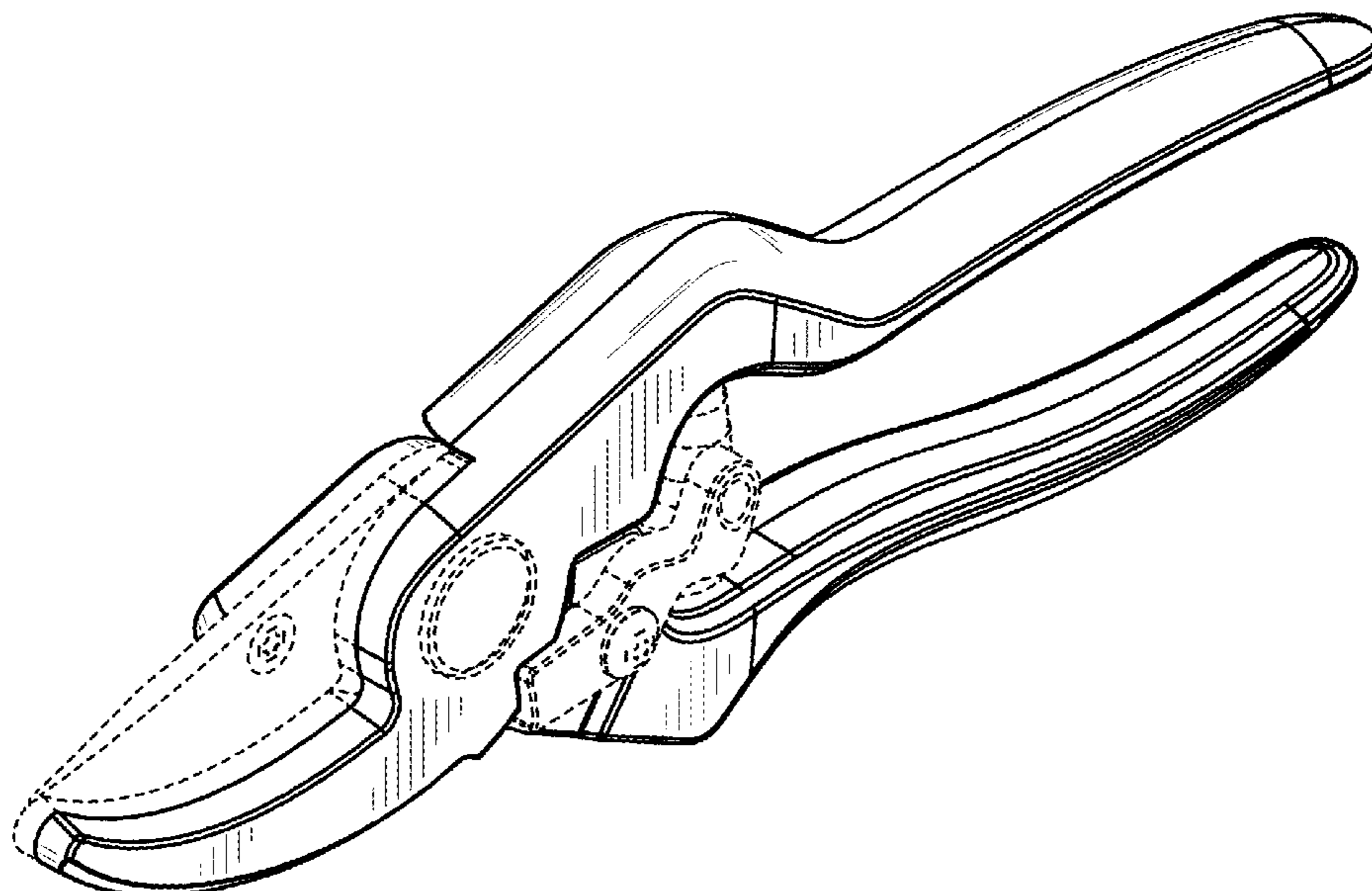



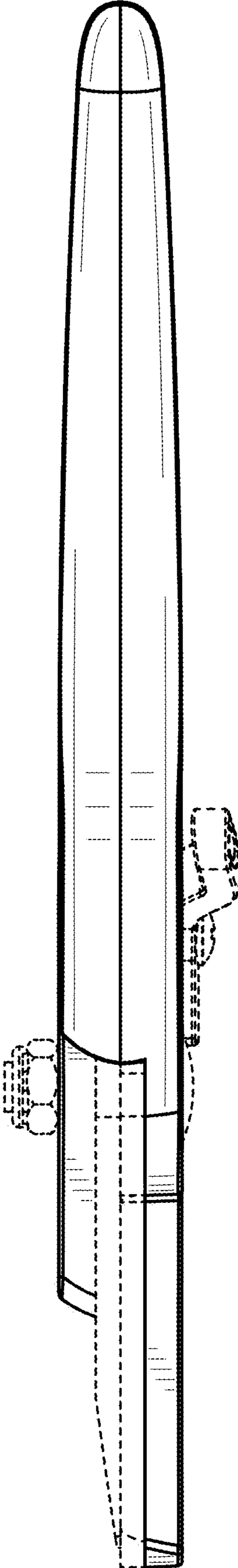

FIG. 1

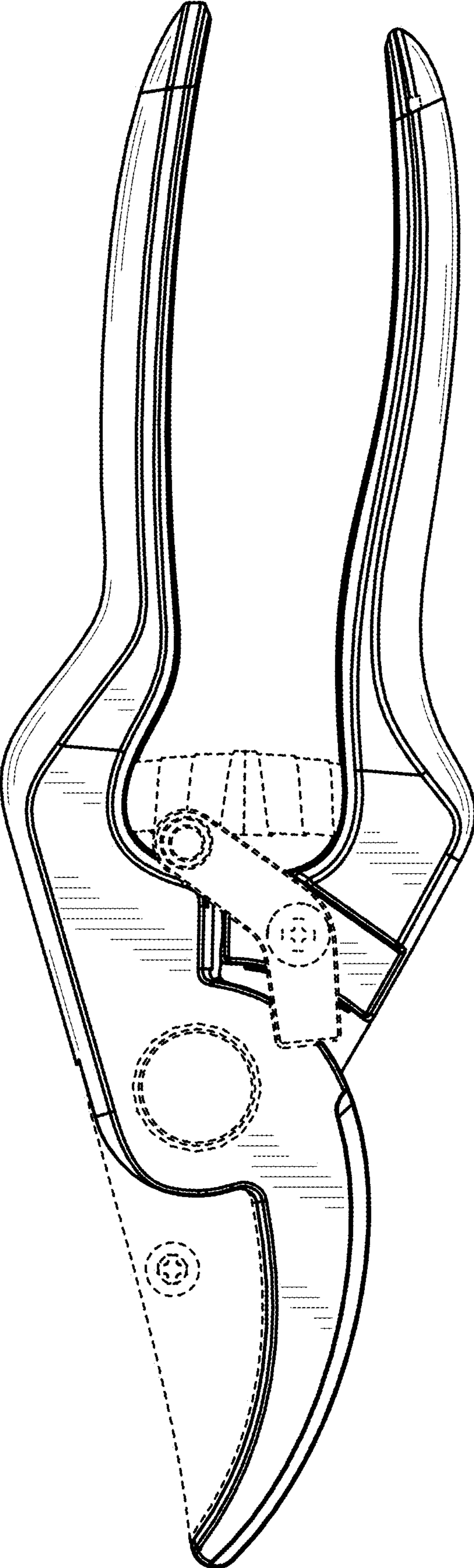

FIG. 2

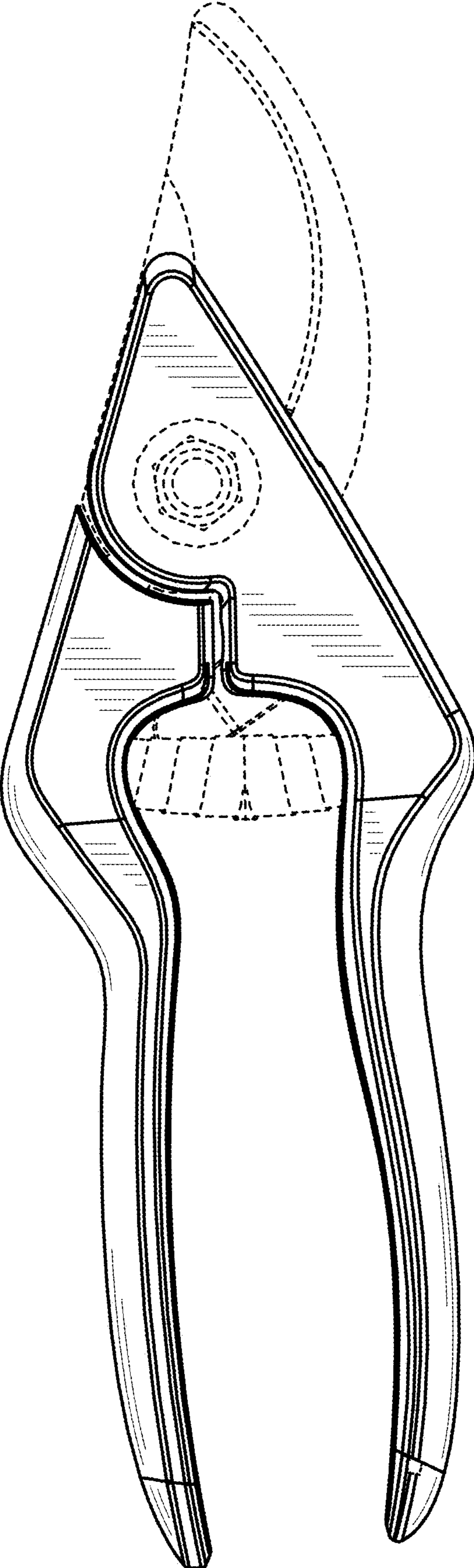

FIG. 3

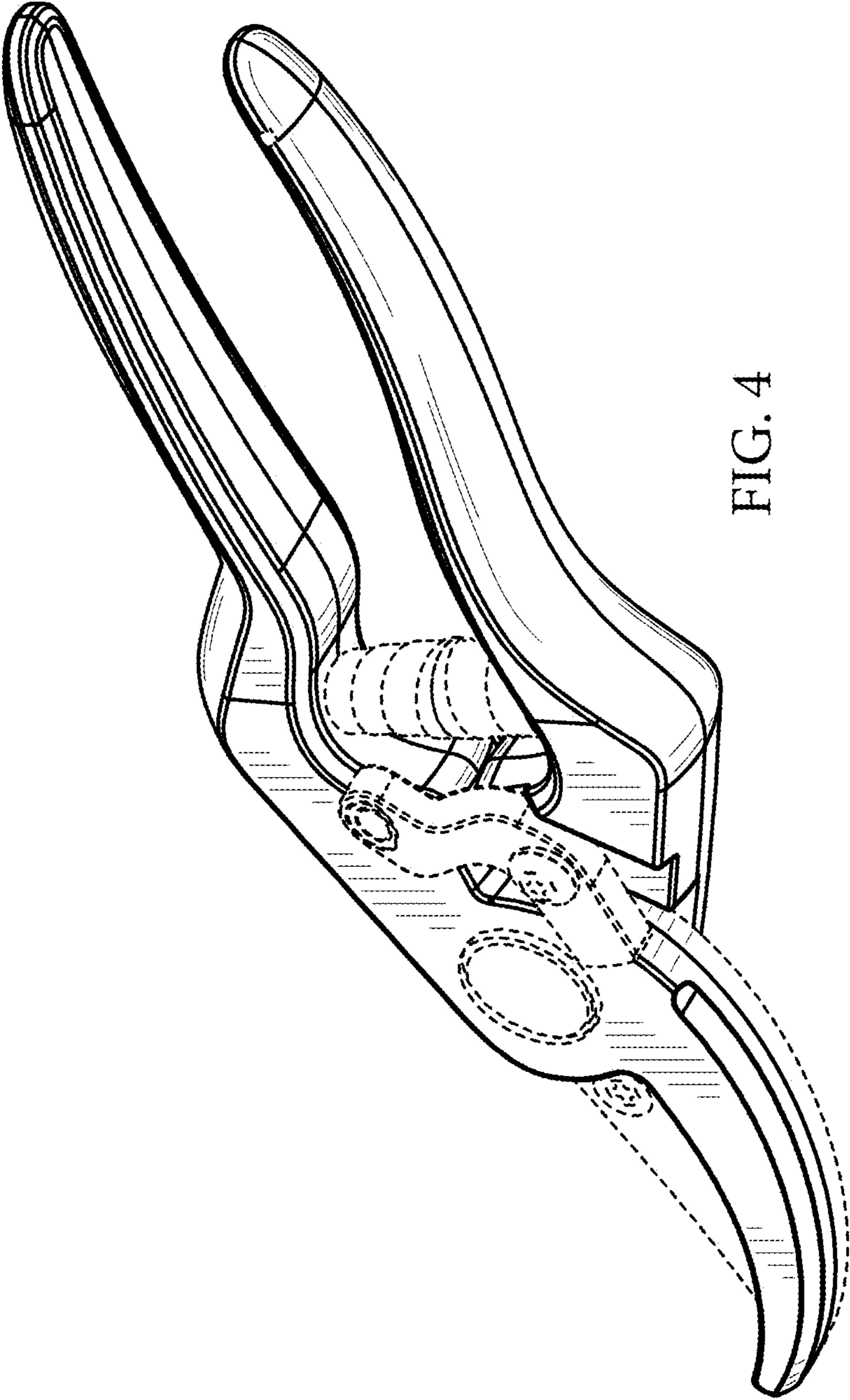

FIG. 4

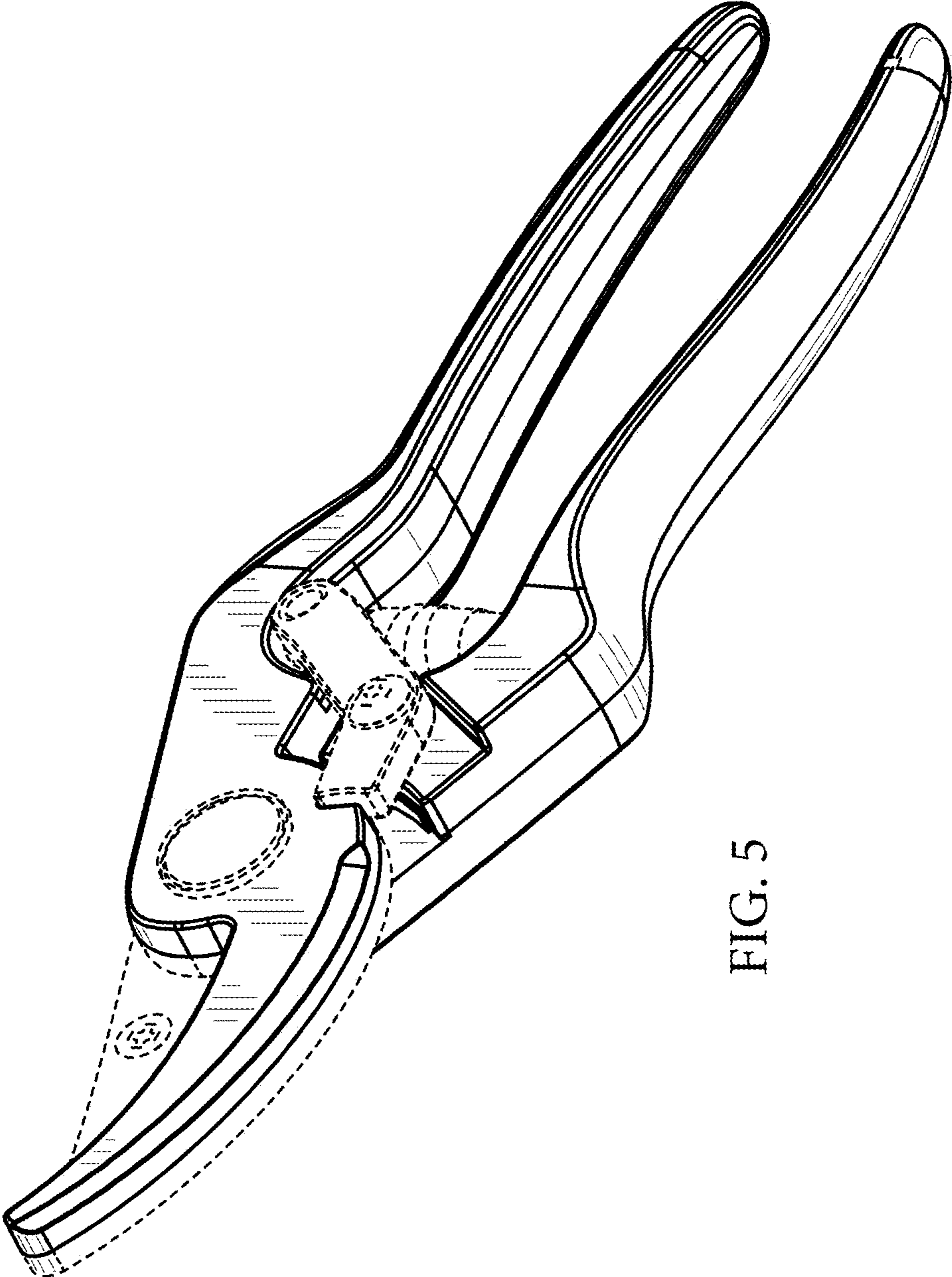

FIG. 5

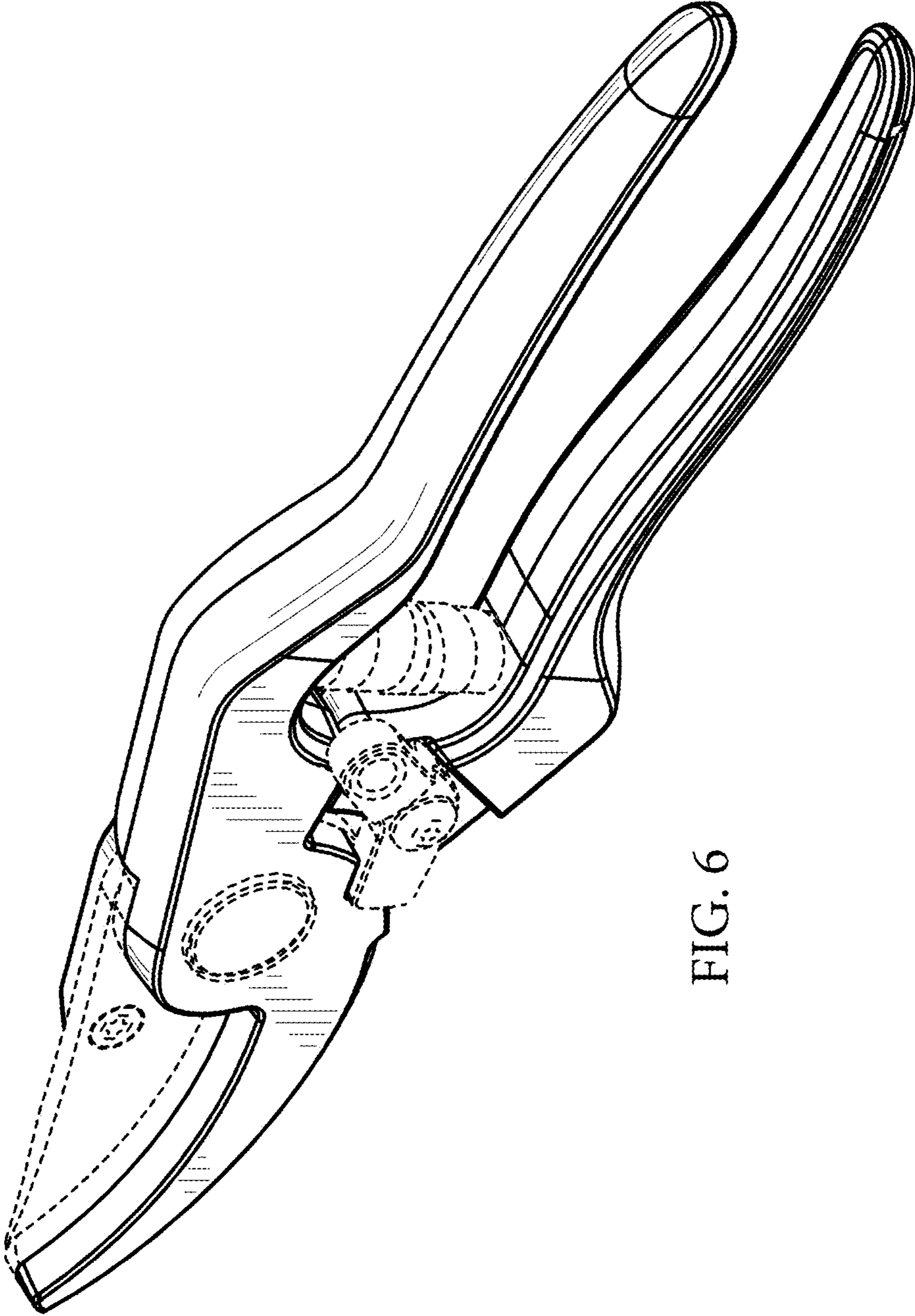

FIG. 6



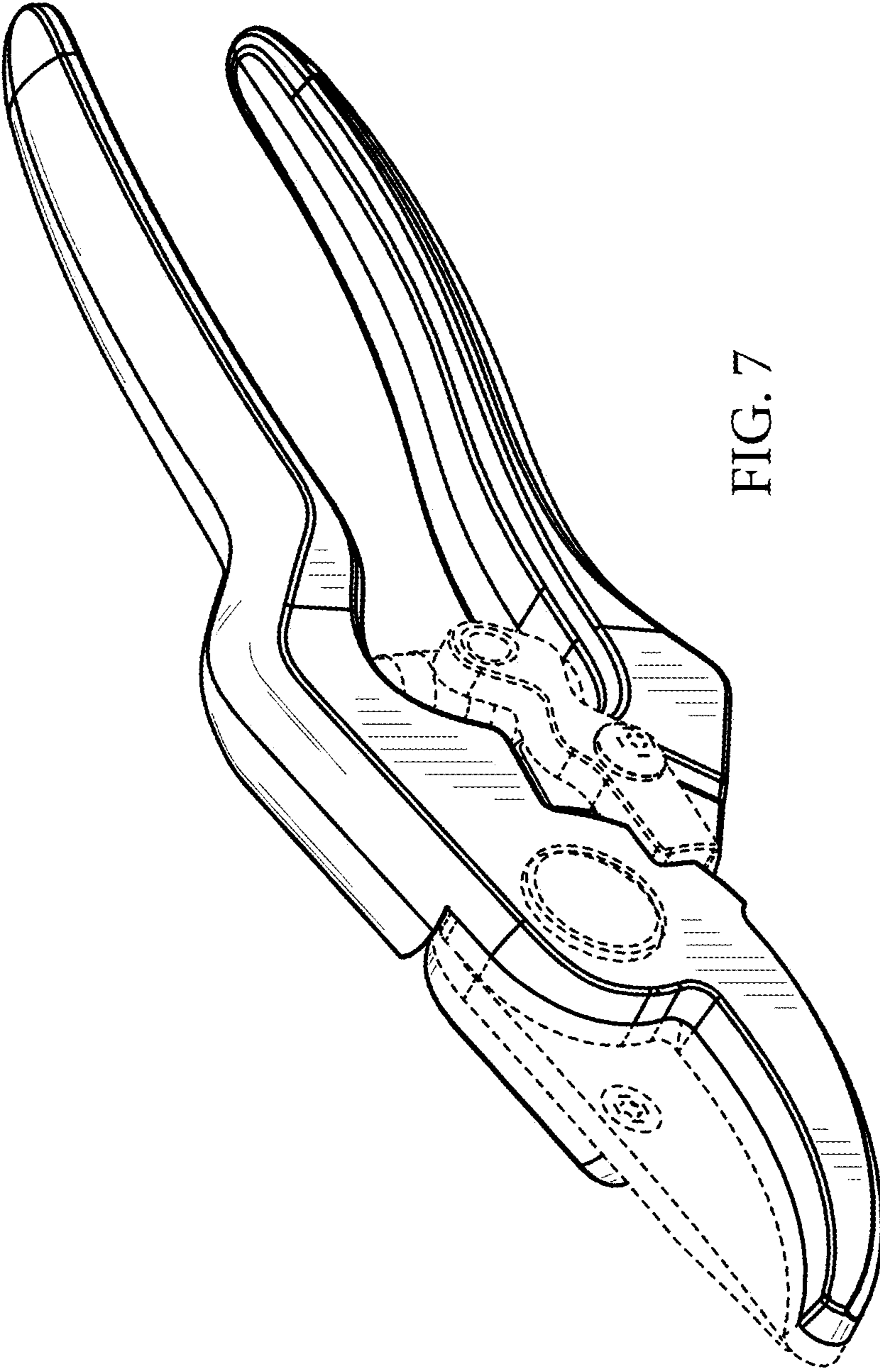

FIG. 7

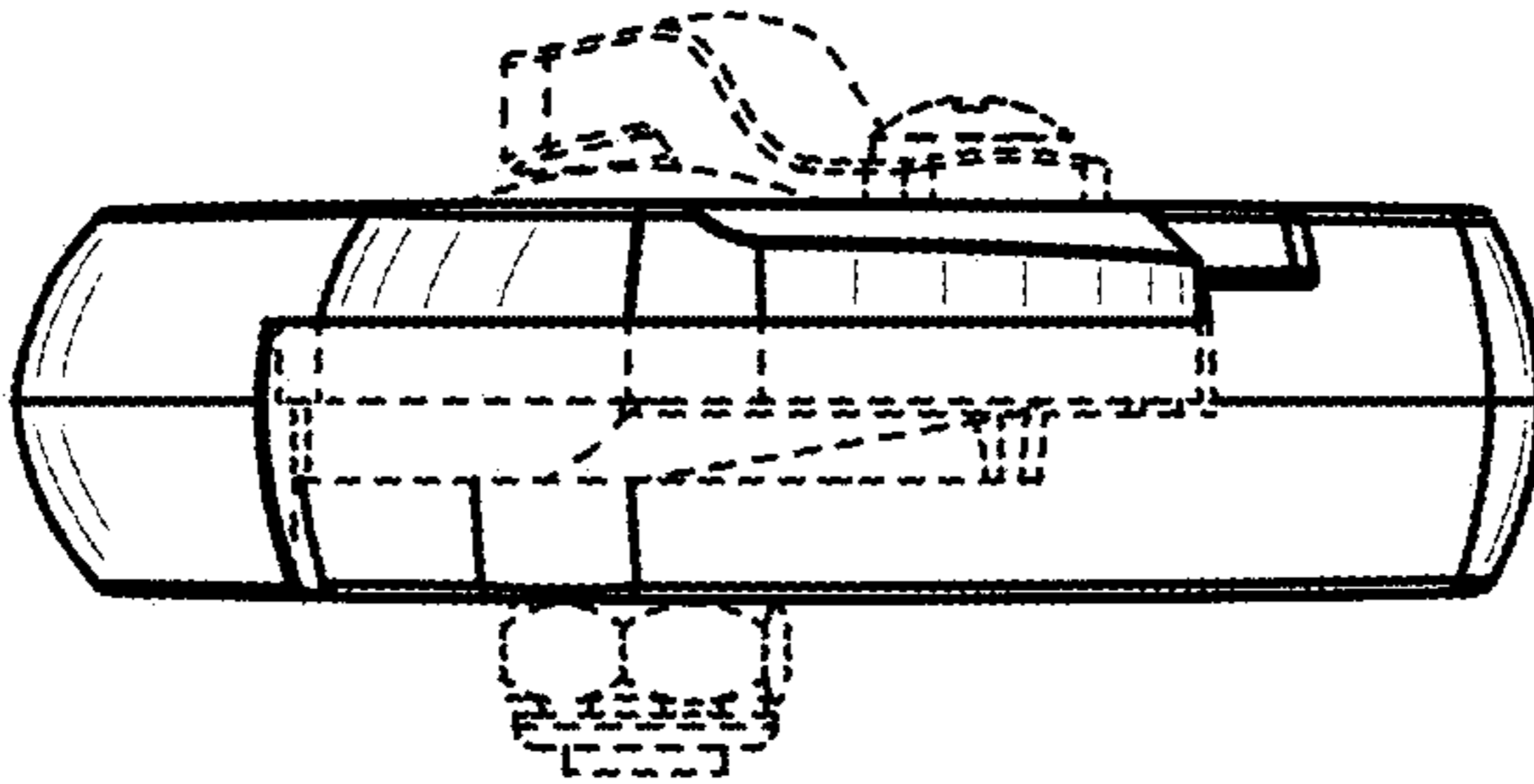

FIG. 8

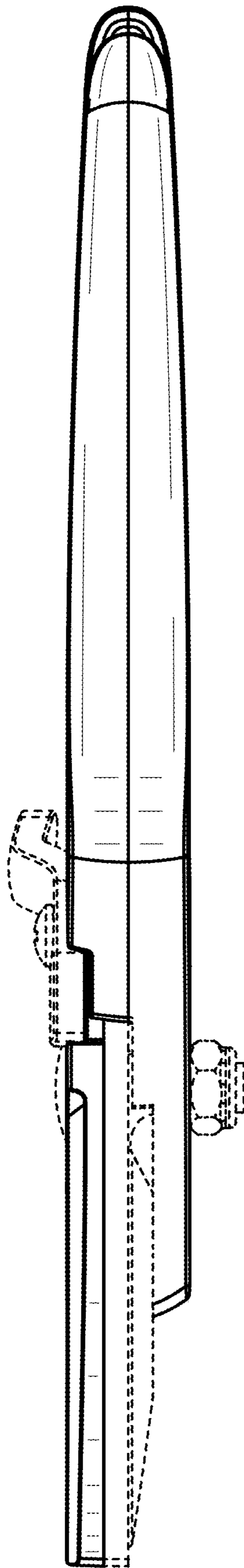

FIG. 9

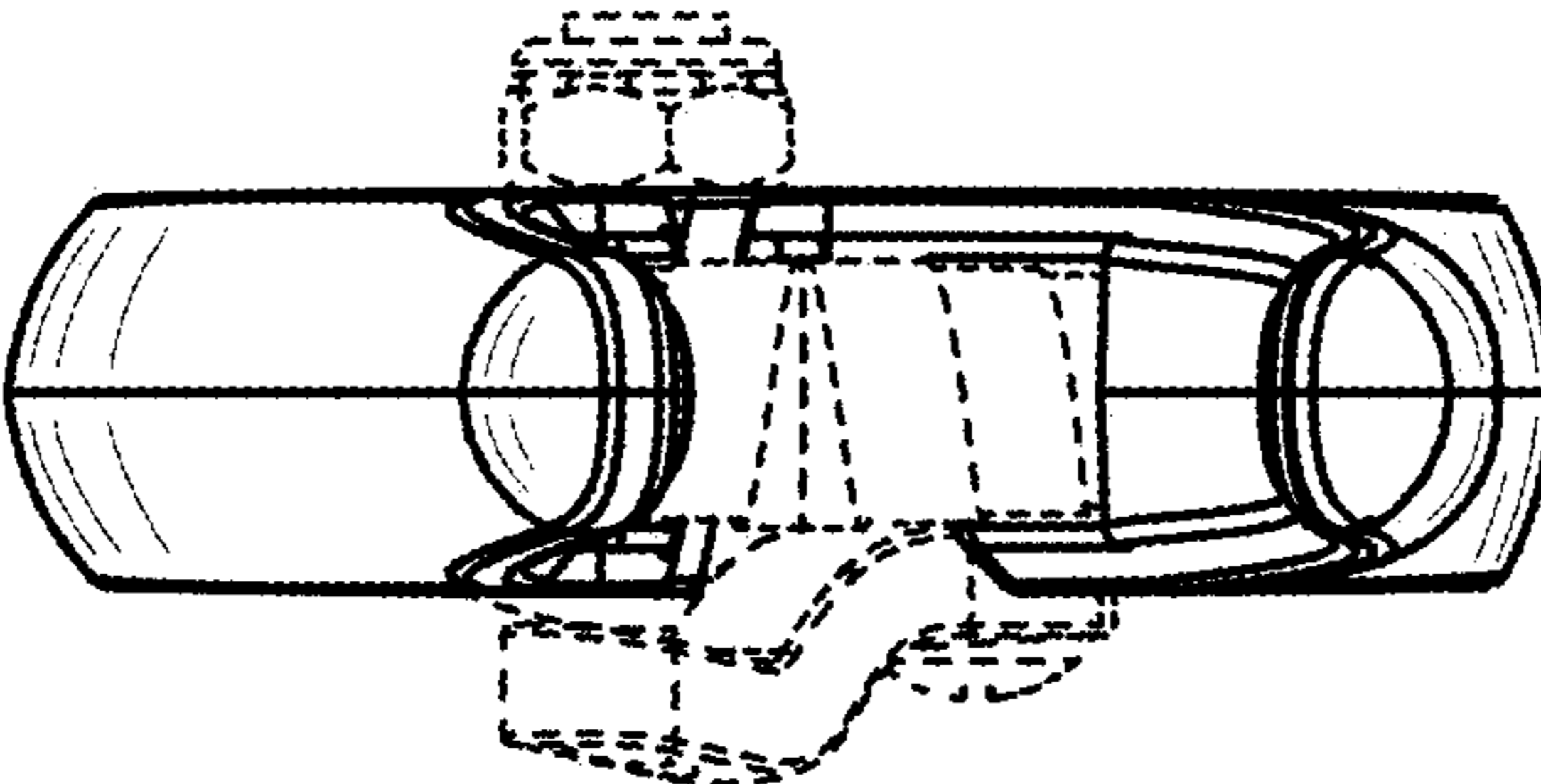

FIG. 10