



US00D922077S

(12) **United States Design Patent**
Lehar

(10) **Patent No.:** **US D922,077 S**
(45) **Date of Patent:** **** Jun. 15, 2021**

- (54) **CHILDREN'S TOOTHBRUSH**
- (71) Applicant: **Nicole Lehar**, Grand Junction, CO (US)
- (72) Inventor: **Nicole Lehar**, Grand Junction, CO (US)
- (**) Term: **15 Years**
- (21) Appl. No.: **29/756,136**
- (22) Filed: **Oct. 26, 2020**

Related U.S. Application Data

- (62) Division of application No. 29/695,857, filed on Jun. 22, 2019, now Pat. No. Des. 903,326.
- (51) **LOC (13) Cl.** **04-02**
- (52) **U.S. Cl.**
USPC **D4/103; D4/107**
- (58) **Field of Classification Search**
USPC D4/100, 101, 102, 104, 105, 106, 107,
D4/108, 109, 110, 111, 112, 113, 114,
D4/115, 116, 119, 130, 132, 133, 134,
D4/136, 137, 138, 199, 103
CPC ... A46B 2200/1066; A46B 5/02; A61C 17/16;
A61C 17/22
See application file for complete search history.

(56) **References Cited**

U.S. PATENT DOCUMENTS

- 5,353,464 A * 10/1994 Atkins A46B 5/00
15/143.1
- D356,928 S * 4/1995 Brown D4/107
- D362,118 S * 9/1995 Nelson D30/158
- D363,166 S * 10/1995 Perrine D4/107
- D404,573 S * 1/1999 Haddad D4/107
- D415,898 S * 11/1999 Haddad D21/599
- D485,072 S * 1/2004 Brown-Paschal D28/65
- 8,137,109 B2 * 3/2012 Gatzemeyer A46B 15/0055
434/238
- D748,397 S * 2/2016 Wagner D4/103
- D756,658 S * 5/2016 Capozza D4/103

- D794,338 S * 8/2017 Griffin D4/107
- 9,820,560 B1 * 11/2017 Crowley A46B 5/04
- D817,002 S * 5/2018 Wainless D4/107
- D863,778 S * 10/2019 Wainless D4/107
- D889,845 S * 7/2020 Sohn D4/101
- 2003/0088933 A1 * 5/2003 Woods A46B 5/02
15/167.1

(Continued)

FOREIGN PATENT DOCUMENTS

- CN 303908373 * 11/2016
- CN 305747706 * 4/2020
- CN 305934919 * 7/2020

Primary Examiner — Karen E Eldridge Powers
(74) *Attorney, Agent, or Firm* — Dentons Durham Jones
Pinegar; Sarah W. Matthews

(57) **CLAIM**

I claim the ornamental design for a children's toothbrush, substantially as shown and described.

DESCRIPTION

FIG. 1 is a perspective view of a children's toothbrush showing my new design.
 FIG. 2 is a front elevation view of the children's toothbrush shown in FIG. 1.
 FIG. 3 is a rear elevation view thereof.
 FIG. 4 is a top plan view thereof.
 FIG. 5 is a bottom plan view thereof.
 FIG. 6 is a right side elevation view thereof; and,
 FIG. 7 is a left side elevation view thereof.
 The broken lines illustrate environmental structure and form no part of the claimed design. The different stippling densities used on the different surfaces are included in the drawings to represent the different degrees of shade cast on each surface, e.g., the surfaces facing the light source having the lightest stippling and the surfaces facing away from the light source having the darkest stippling.

1 Claim, 4 Drawing Sheets

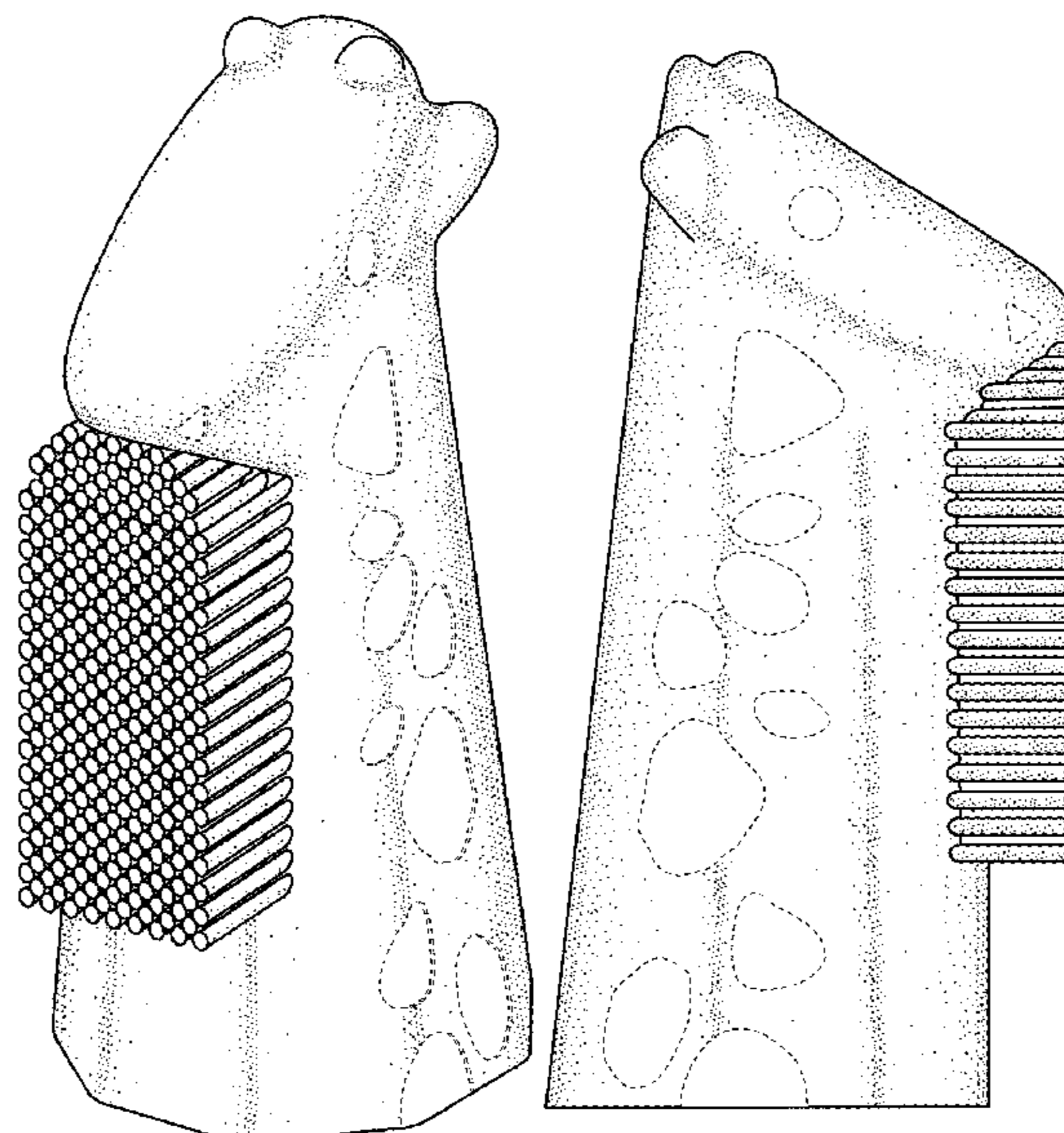

(56)

References Cited

U.S. PATENT DOCUMENTS

2020/0008565 A1* 1/2020 Lehar A46B 3/005
2020/0138555 A1* 5/2020 Sohn A46B 15/0008

* cited by examiner

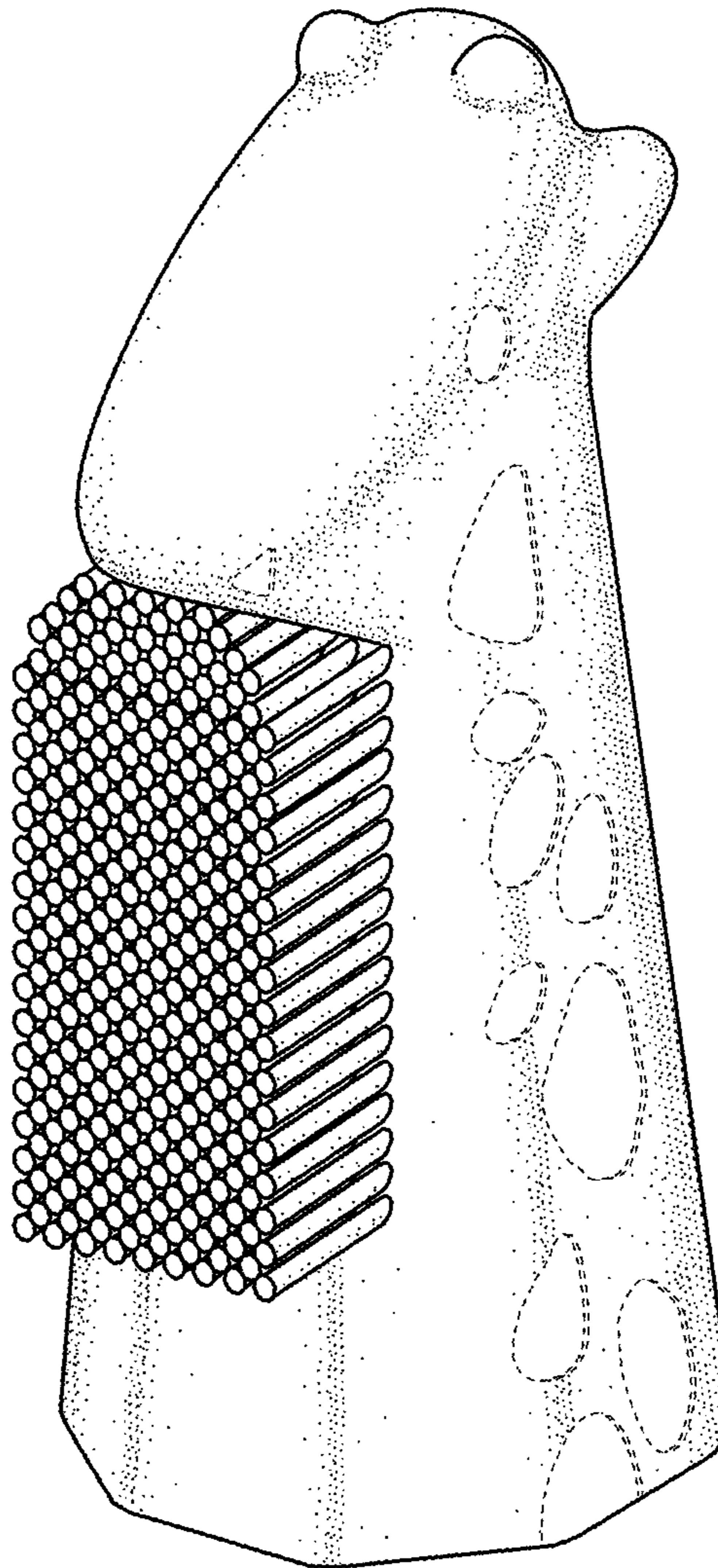

FIG. 1

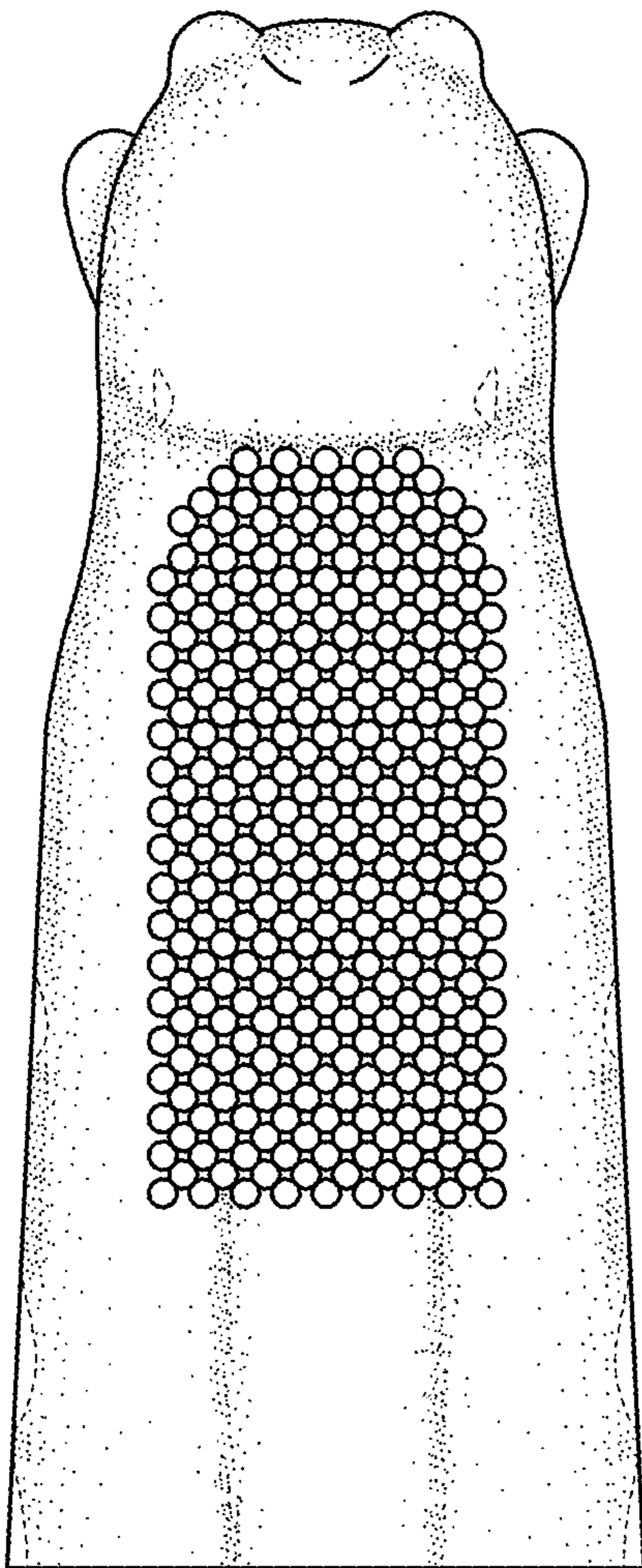

FIG. 2

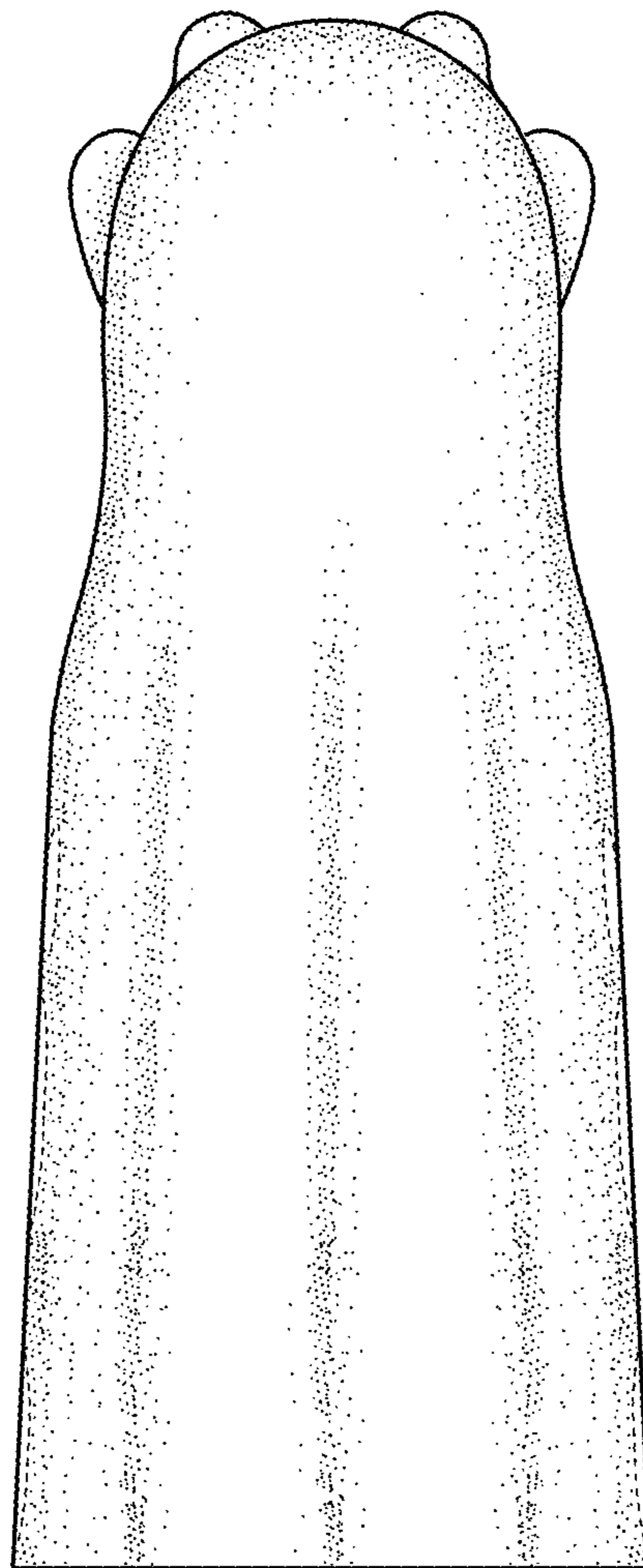

FIG. 3

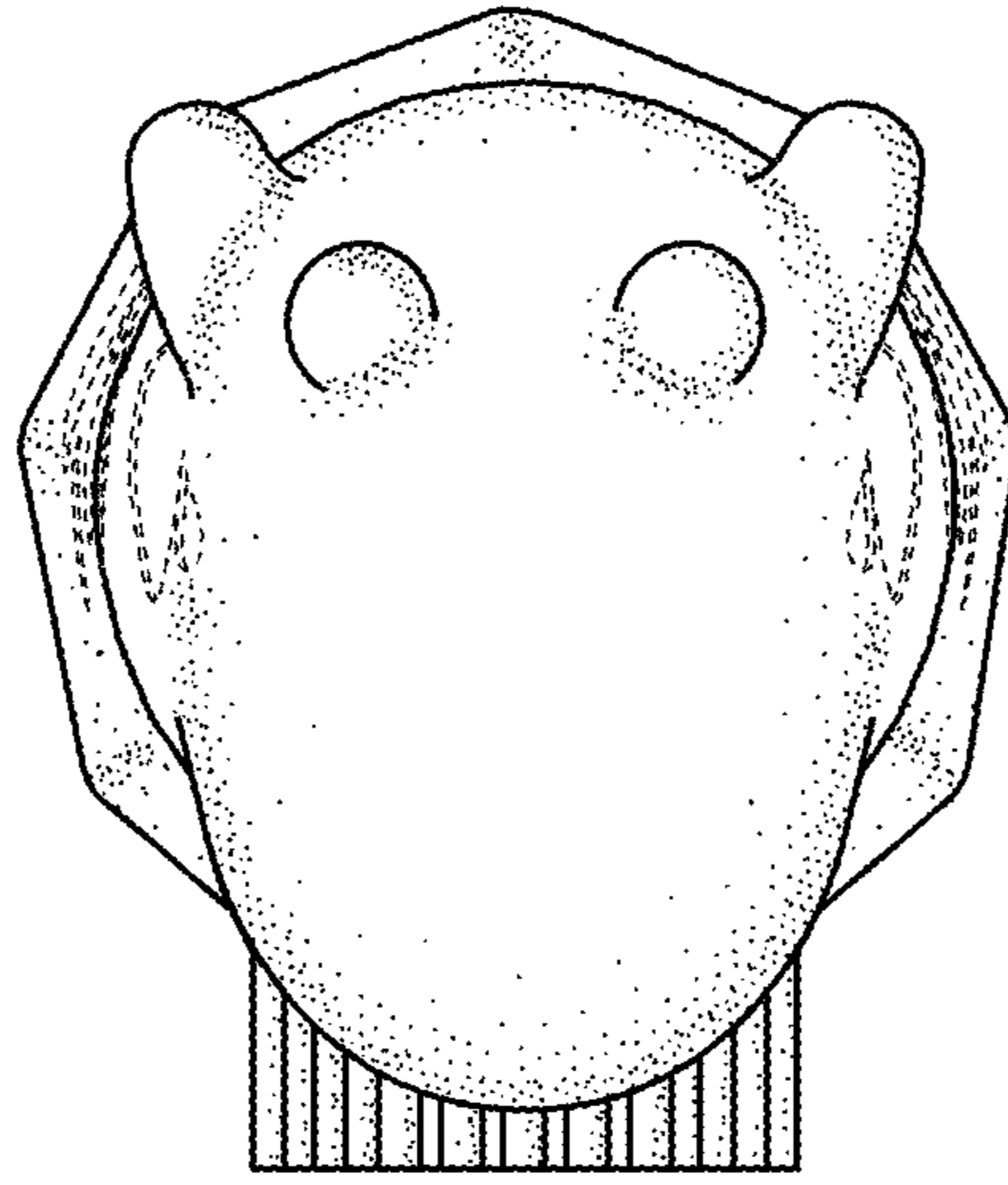

FIG. 4

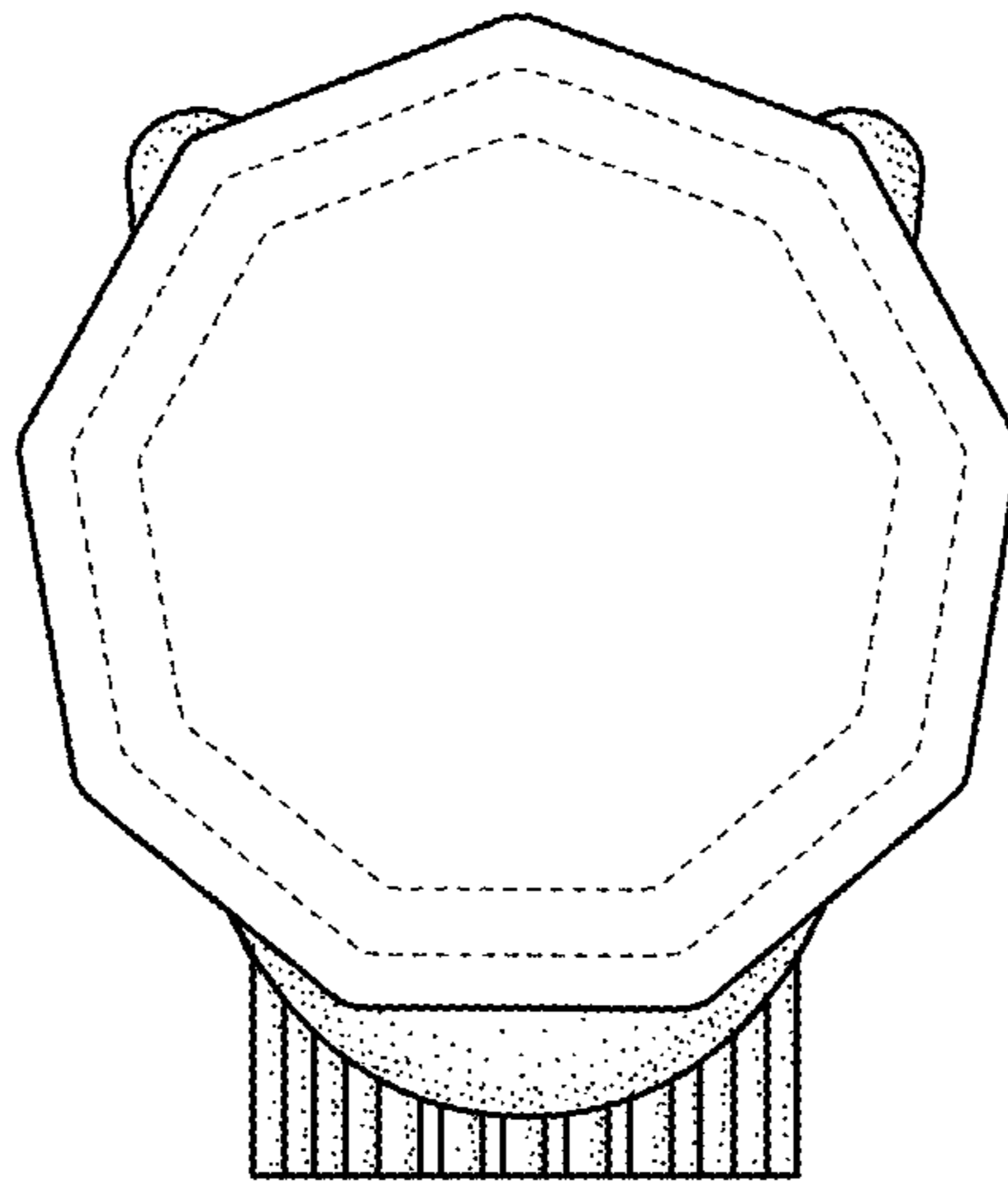

FIG. 5

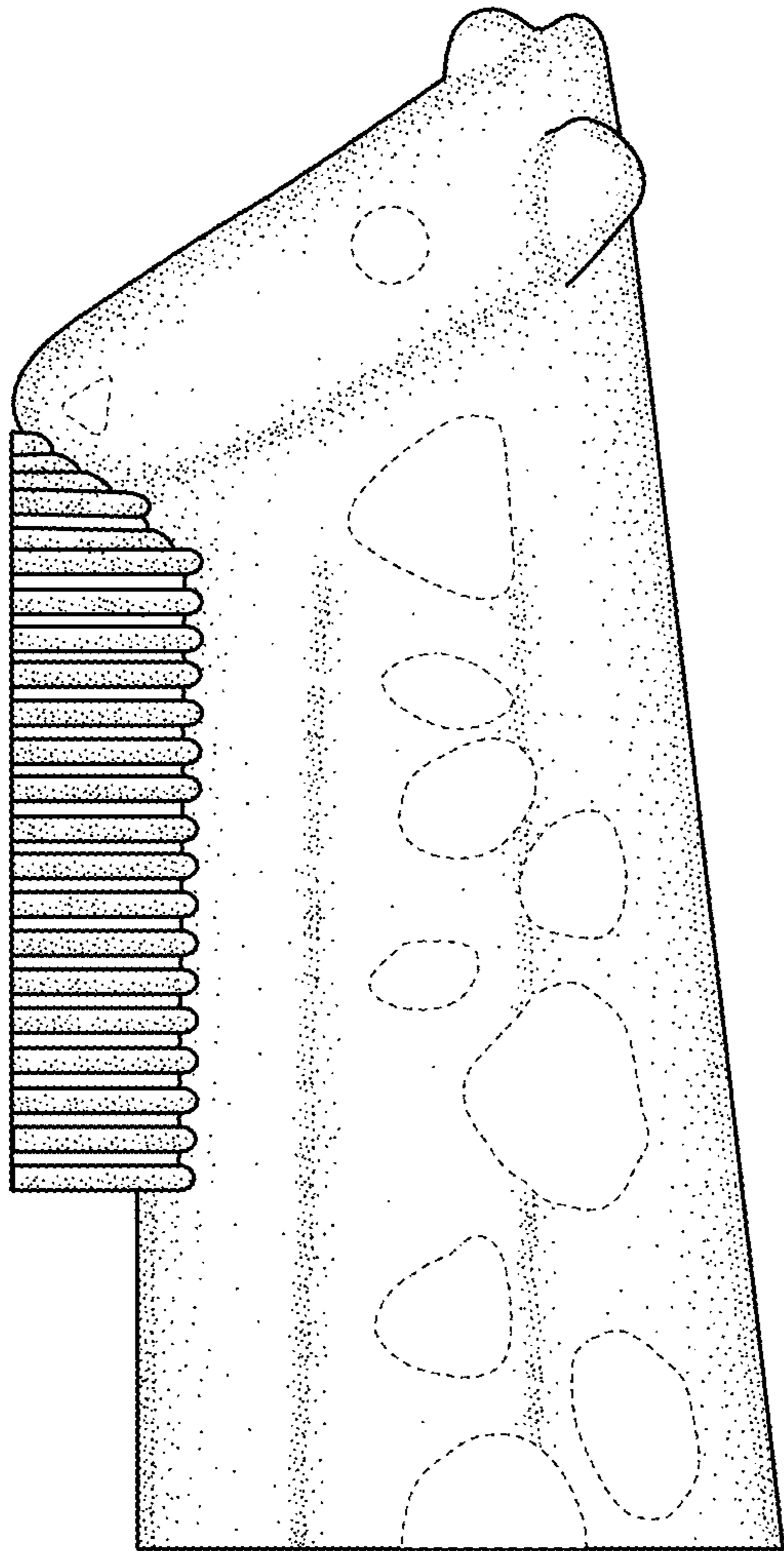

FIG. 6

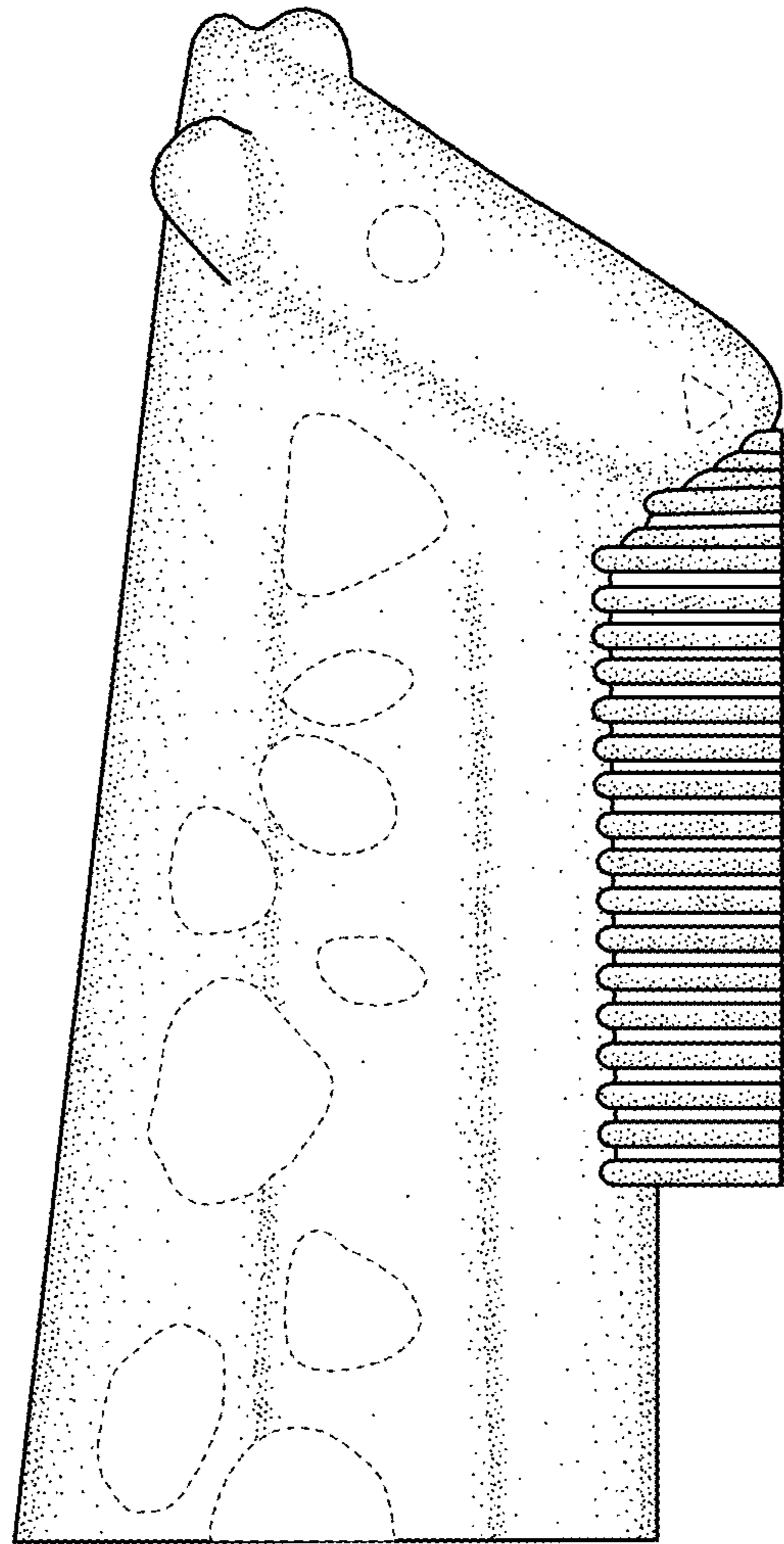

FIG. 7