



US00D922071S

(12) **United States Design Patent** (10) **Patent No.:** **US D922,071 S**
Jensen (45) **Date of Patent:** **** Jun. 15, 2021**

(54) **PRODUCT CONTAINER**
(71) Applicant: **Lifestyle Products, LLC**, Logan, UT (US)
(72) Inventor: **Robyn Jensen**, Hyde Park, UT (US)
(73) Assignee: **Lifestyle Products, LLC**, Logan, UT (US)
(**) Term: **15 Years**
(21) Appl. No.: **29/729,318**
(22) Filed: **Mar. 25, 2020**
(51) **LOC (13) Cl.** **03-01**
(52) **U.S. Cl.**
USPC **D3/302**; D3/271.1; D9/600; D28/76
(58) **Field of Classification Search**
USPC D3/20, 24, 25, 274, 276, 291, 302, 905, D3/294, 201, 203.1, 203.2, 273, 295, 298, D3/318, 901, 902, 903, 217, 271.1; D9/669, 661, 664, 653, 600; D28/79, 81, D28/76
CPC A45F 3/48; B65D 50/04; A45C 2011/001; A45C 2011/003
See application file for complete search history.

D452,350 S * 12/2001 Huang D28/76
D462,898 S 9/2002 Weinstock
D463,586 S 9/2002 Kumar
D478,180 S 8/2003 Boss
D505,517 S * 5/2005 Baresi D28/76
D508,166 S * 8/2005 Liu 3/271.1
D529,396 S 10/2006 Whipple
D575,508 S * 8/2008 Shanahan D3/211
D584,579 S 1/2009 Vendl
D600,159 S 11/2009 Tsai
D604,570 S 11/2009 Frank
D626,427 S 11/2010 Andreotti
D655,643 S 3/2012 Bardash
D678,781 S 3/2013 Andreotti
D678,782 S 3/2013 Andreotti
D680,006 S 4/2013 Andreotti
D685,647 S 7/2013 Andreotti
D697,676 S 1/2014 Hansen
D712,742 S 9/2014 Masanek
D729,576 S 5/2015 Habig
D730,188 S 5/2015 Masanek
D763,696 S * 8/2016 Eisen D9/541

(Continued)

Primary Examiner — April Rivas
(74) Attorney, Agent, or Firm — Preston P. Frischknecht; Project CIP

(57) **CLAIM**
The ornamental design for a product container, as shown.

DESCRIPTION

FIG. 1 is a front perspective view;
FIG. 2 is a front perspective view in an exploded configuration;
FIG. 3 is a front side view;
FIG. 4 is a back side view;
FIG. 5 is a left side view;
FIG. 6 is a right side view;
FIG. 7 is a top plan view; and,
FIG. 8 is a bottom plan view.

1 Claim, 6 Drawing Sheets

(56) **References Cited**
U.S. PATENT DOCUMENTS
D10,435 S * 2/1878 Luchs D9/430
D96,125 S * 7/1935 Lewis D28/79
D145,491 S * 8/1946 Stack, Jr. D28/78
D170,904 S 11/1953 Bell
D246,833 S 1/1978 Campbell
D258,201 S 2/1981 Cassini
D279,277 S 6/1985 Andrus
D403,557 S 1/1999 Kracke
D431,187 S 9/2000 Davis
D449,981 S 11/2001 Davis

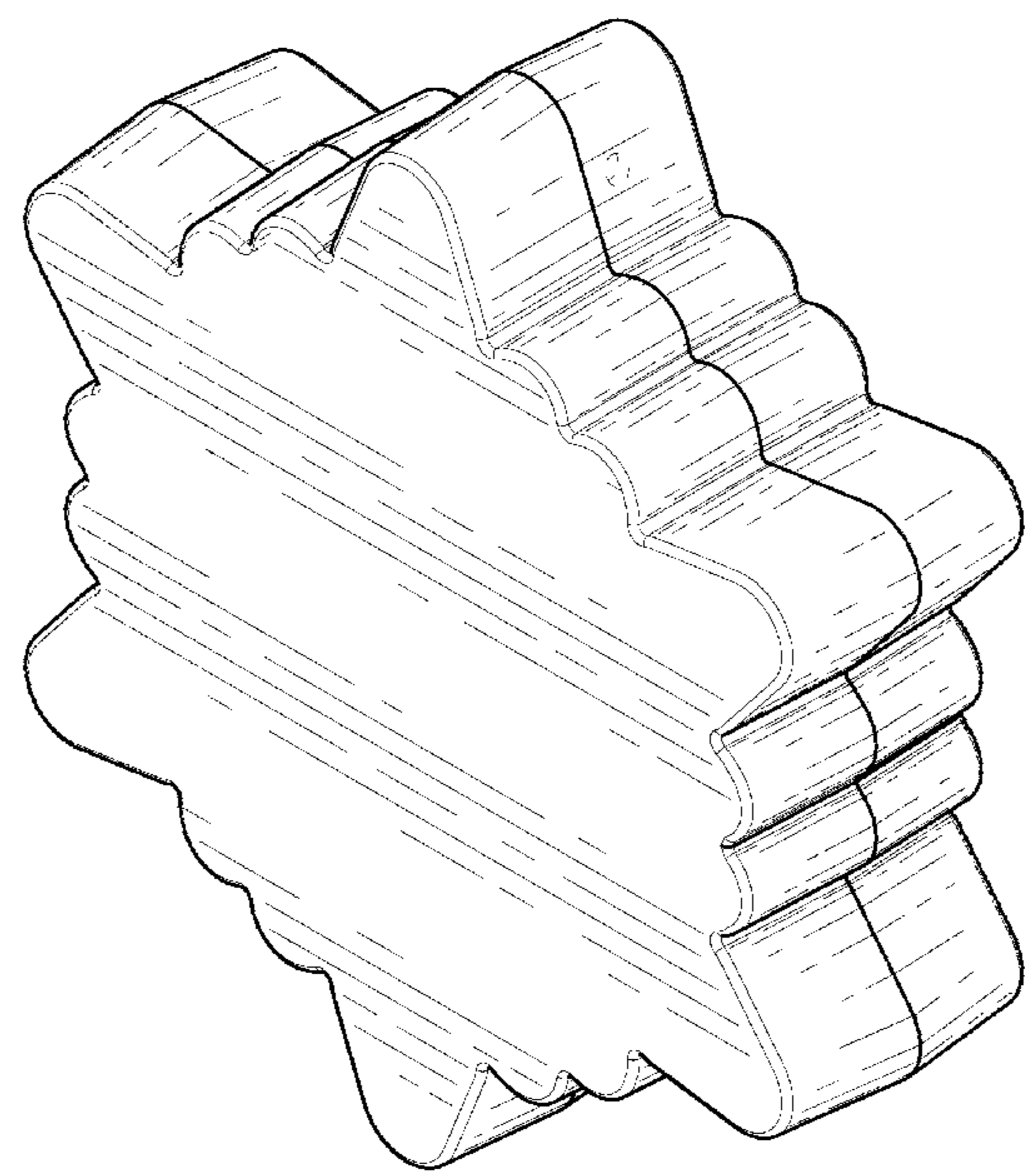

(56)

References Cited

U.S. PATENT DOCUMENTS

D778,165	S	2/2017	Feletto	
D801,851	S *	11/2017	Maufas	D11/99
D803,069	S	11/2017	Figuls	
D833,280	S	11/2018	Katopis	
D850,005	S *	5/2019	Silva	D28/79
D873,472	S	1/2020	Chen	
D875,545	S	2/2020	Bagramyan	
D899,965	S	9/2020	Zhou	
D902,995	S	11/2020	Schaffer	
D915,067	S *	4/2021	Sakai	3/271.1
2017/0143102	A1 *	5/2017	Silva	A45D 42/02

* cited by examiner

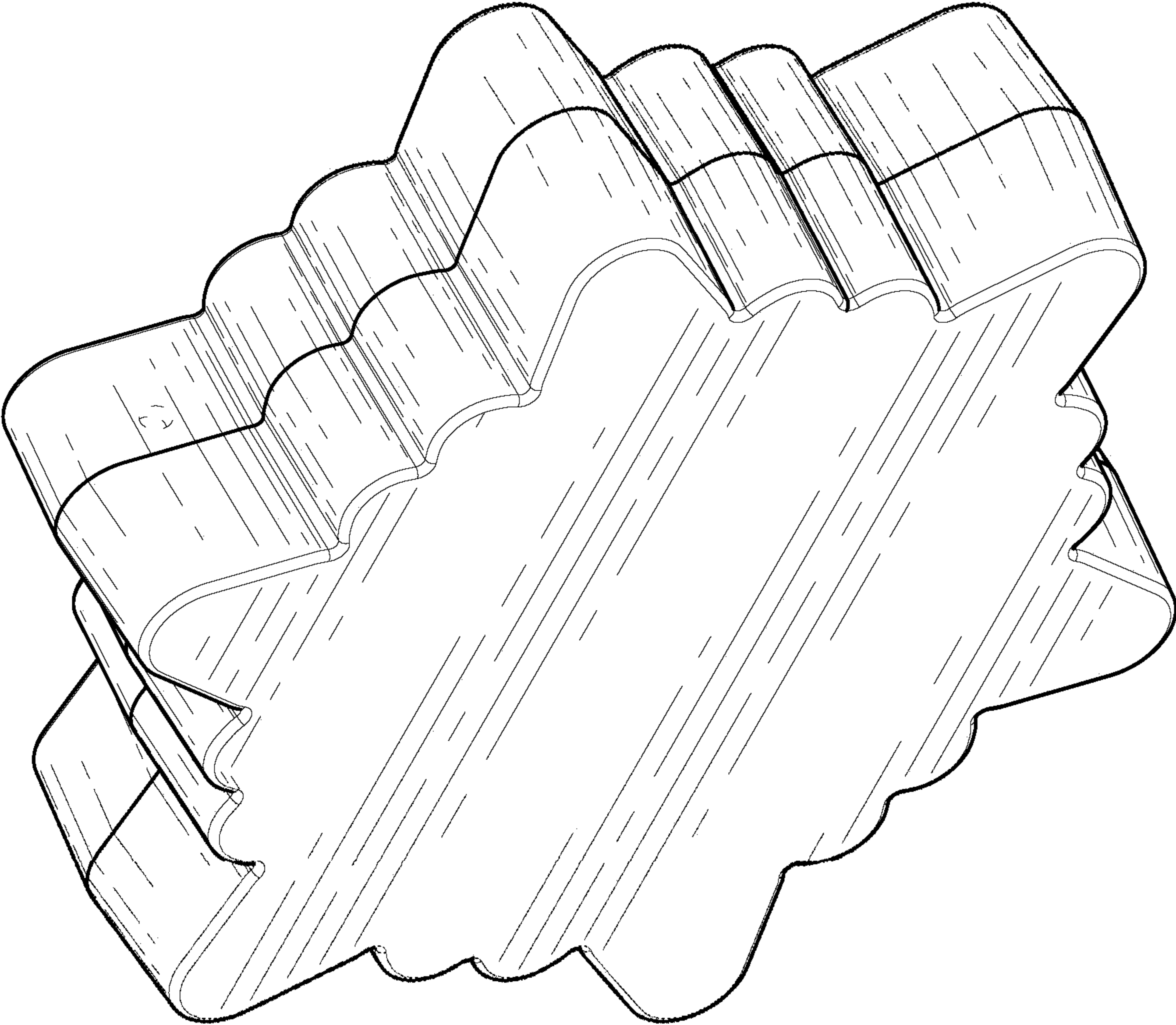

FIG. 1

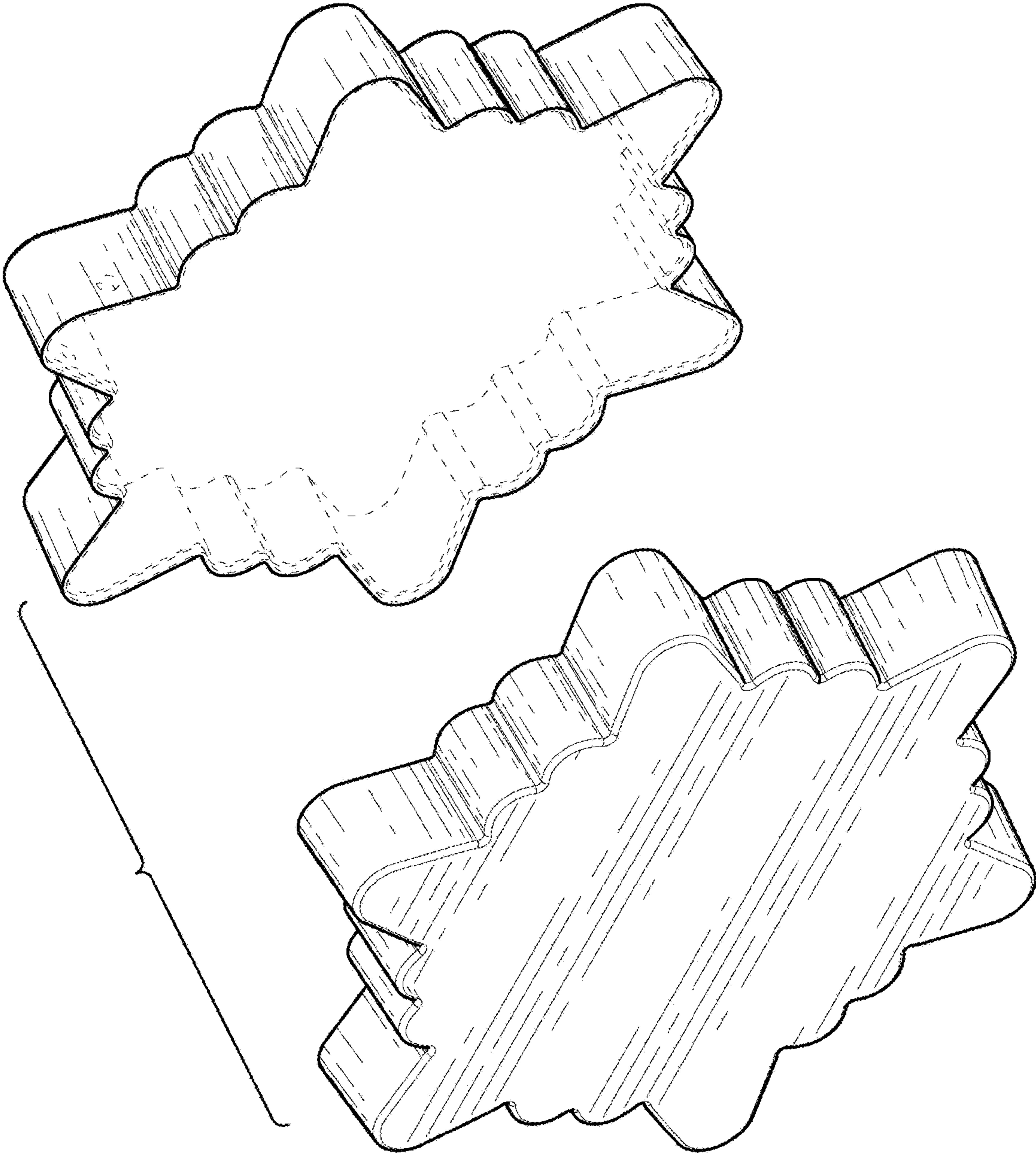

FIG. 2

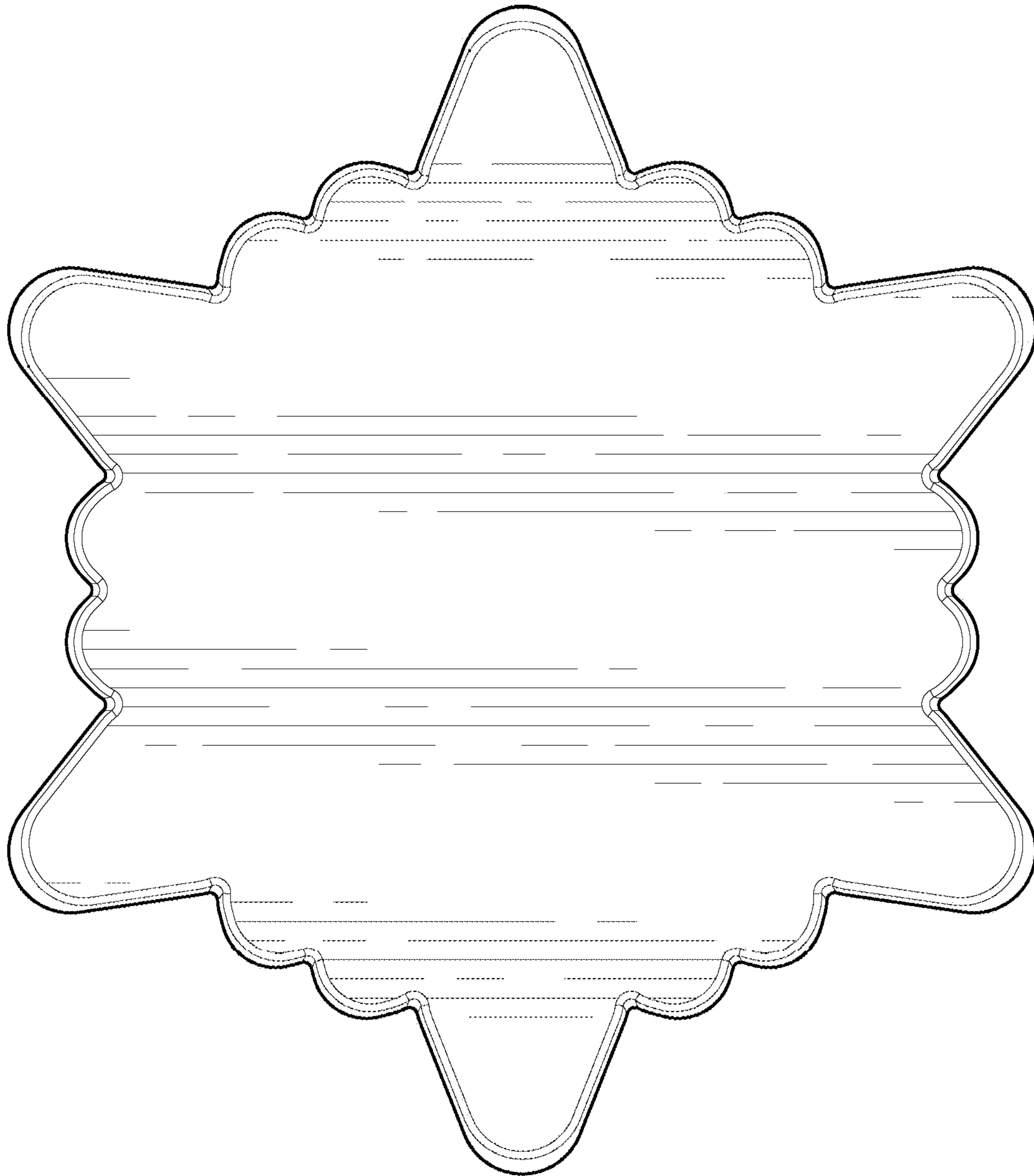

FIG. 3

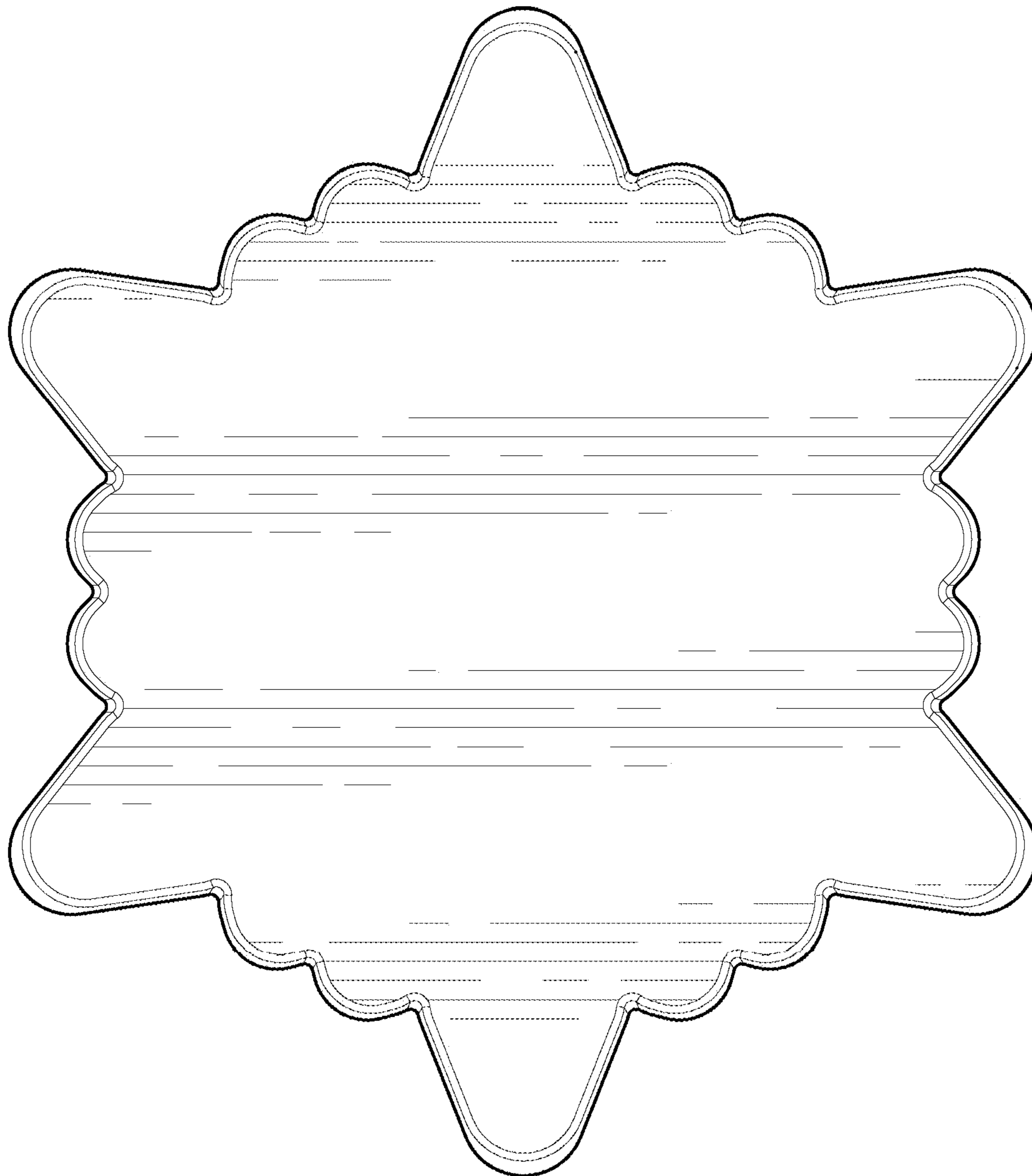

FIG. 4

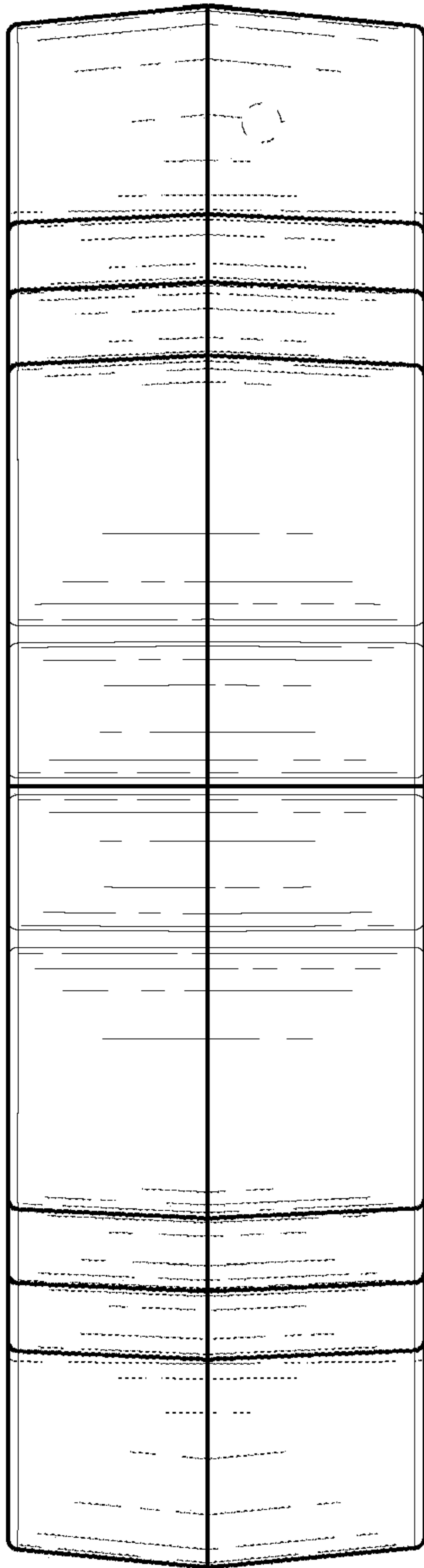

FIG. 5

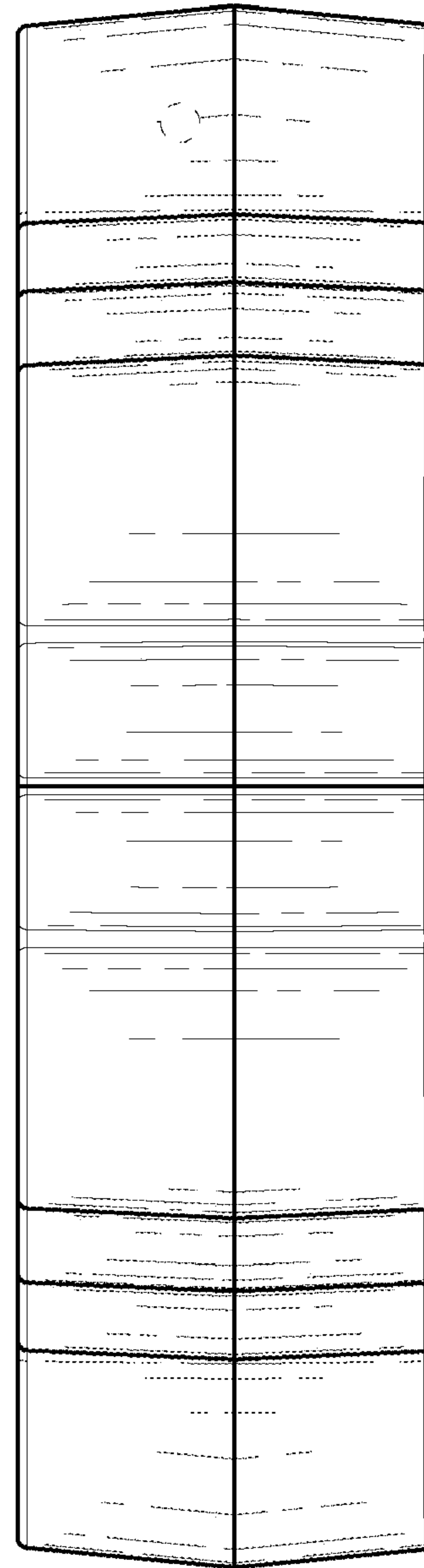

FIG. 6

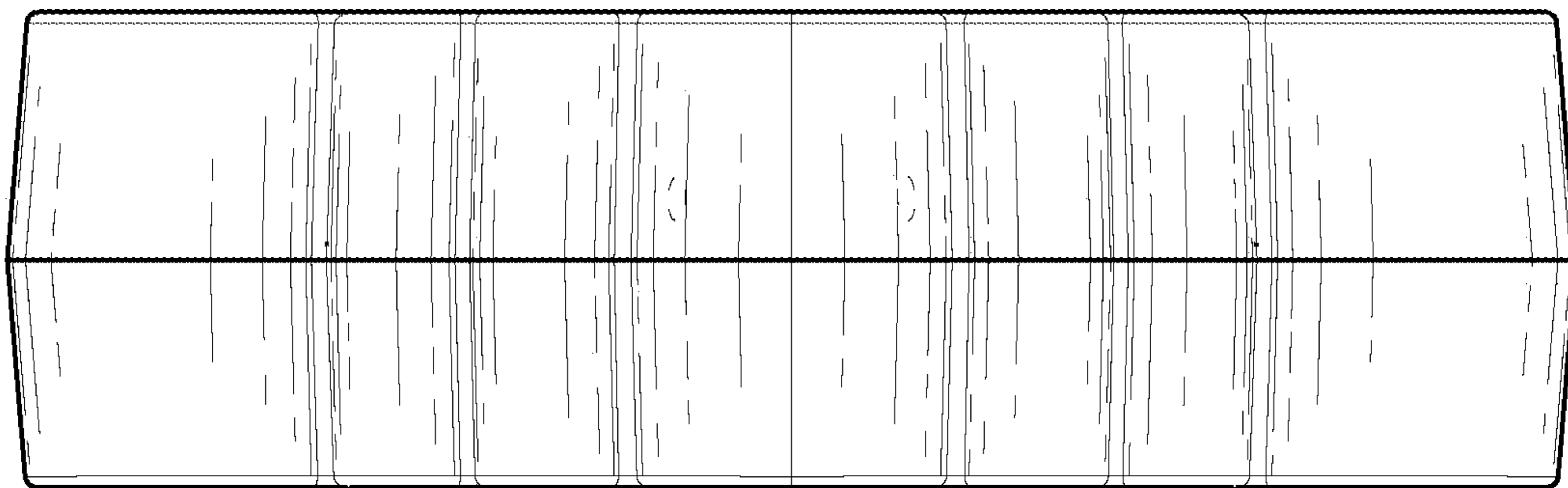

FIG. 7

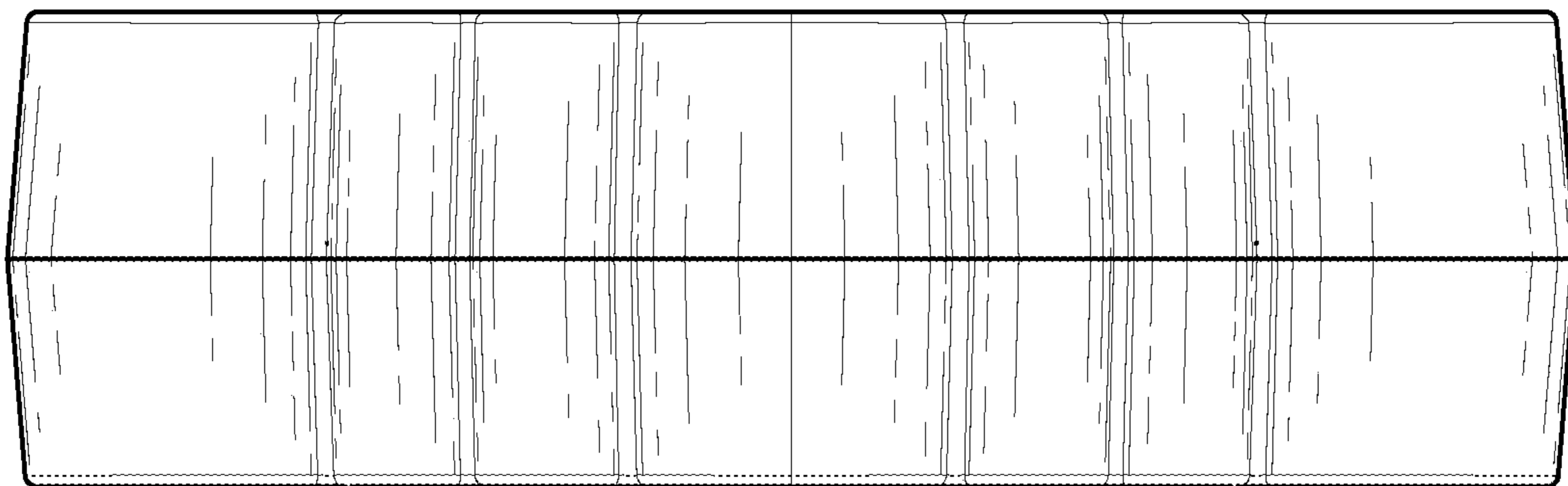

FIG. 8