



US00D922018S

(12) **United States Design Patent** (10) **Patent No.:** **US D922,018 S**
Chaffee et al. (45) **Date of Patent:** **** Jun. 8, 2021**

(54) **REFILLABLE CLEANING TOOL**
(71) Applicant: **3M INNOVATIVE PROPERTIES COMPANY**, St. Paul, MN (US)
(72) Inventors: **Matthew D. Chaffee**, Minneapolis, MN (US); **Mark W. Baldwin**, Woobury, MN (US)
(73) Assignee: **3M Innovative Properties Company**, St. Paul, MN (US)
(**) Term: **15 Years**
(21) Appl. No.: **29/704,576**
(22) Filed: **Sep. 5, 2019**
(51) **LOC (13) Cl.** **07-05**
(52) **U.S. Cl.**
USPC **D32/45**
(58) **Field of Classification Search**
USPC D32/15, 17, 22, 24, 40, 45, 50-52, 70
CPC . B08B 3/00; A47L 11/34; A47L 13/12; A47L 13/22; A47L 11/30
See application file for complete search history.

D707,007 S * 6/2014 Smith D32/70
D738,058 S * 9/2015 La Rovere D32/70
D841,912 S * 2/2019 Renner D32/40
D841,917 S * 2/2019 Renner D32/45
D842,570 S * 3/2019 Meier D32/40
D851,346 S * 6/2019 Kamody D32/40

FOREIGN PATENT DOCUMENTS

CN 304924531 * 12/2018

OTHER PUBLICATIONS

Scotch-Brite Utility Brush : Target, reviews 2019, [https://www.target.com/p/scotch-brite-utility-brush/-/A-14762347?ref=tgt_adv_XS00000...site visited Oct. 24, 2020.*](https://www.target.com/p/scotch-brite-utility-brush/-/A-14762347?ref=tgt_adv_XS00000...)

* cited by examiner

Primary Examiner — John R Yeh

(57) **CLAIM**

The ornamental design for a refillable cleaning tool, as shown and described.

DESCRIPTION

FIG. 1 is a perspective view showing the new design for a refillable cleaning tool;
FIG. 2 is a front view thereof;
FIG. 3 is a rear view thereof;
FIG. 4 is a right view thereof;
FIG. 5 is a left view thereof;
FIG. 6 is a top view thereof; and,
FIG. 7 is a bottom view thereof.
The portions of the refillable cleaning tool in FIGS. 1-7 shown in broken lines are included to show features that form no part of the claimed design.

1 Claim, 5 Drawing Sheets

(56) **References Cited**
U.S. PATENT DOCUMENTS
2,298,113 A * 10/1942 Ely D06F 75/38
38/93
D392,079 S * 3/1998 Omerza D32/40
D496,510 S * 9/2004 Colburn D32/40
D496,511 S * 9/2004 Colburn D32/40
D496,766 S * 9/2004 Colburn D32/40
D519,012 S * 4/2006 Miller D8/107
D620,215 S * 7/2010 Peng D32/52

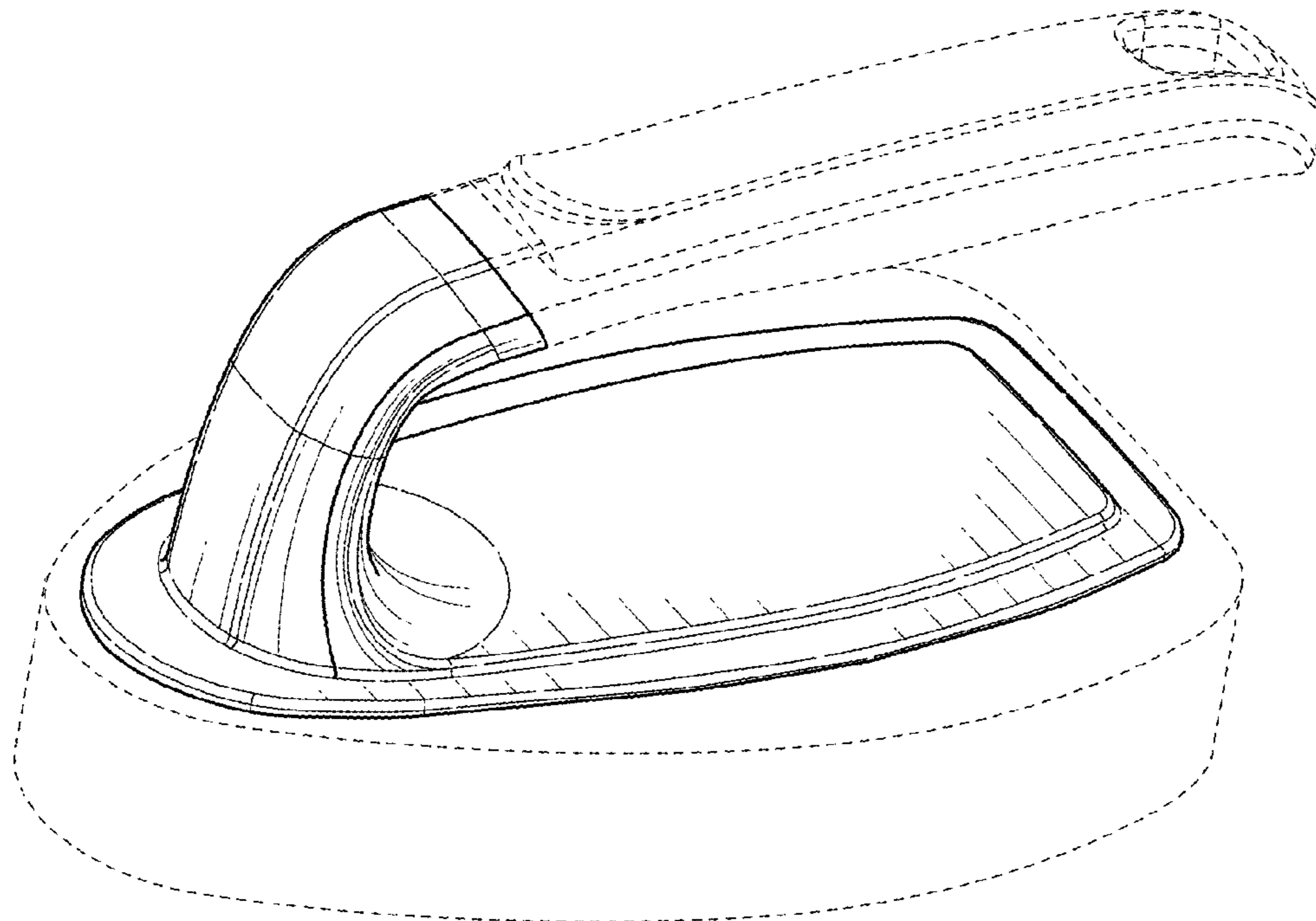

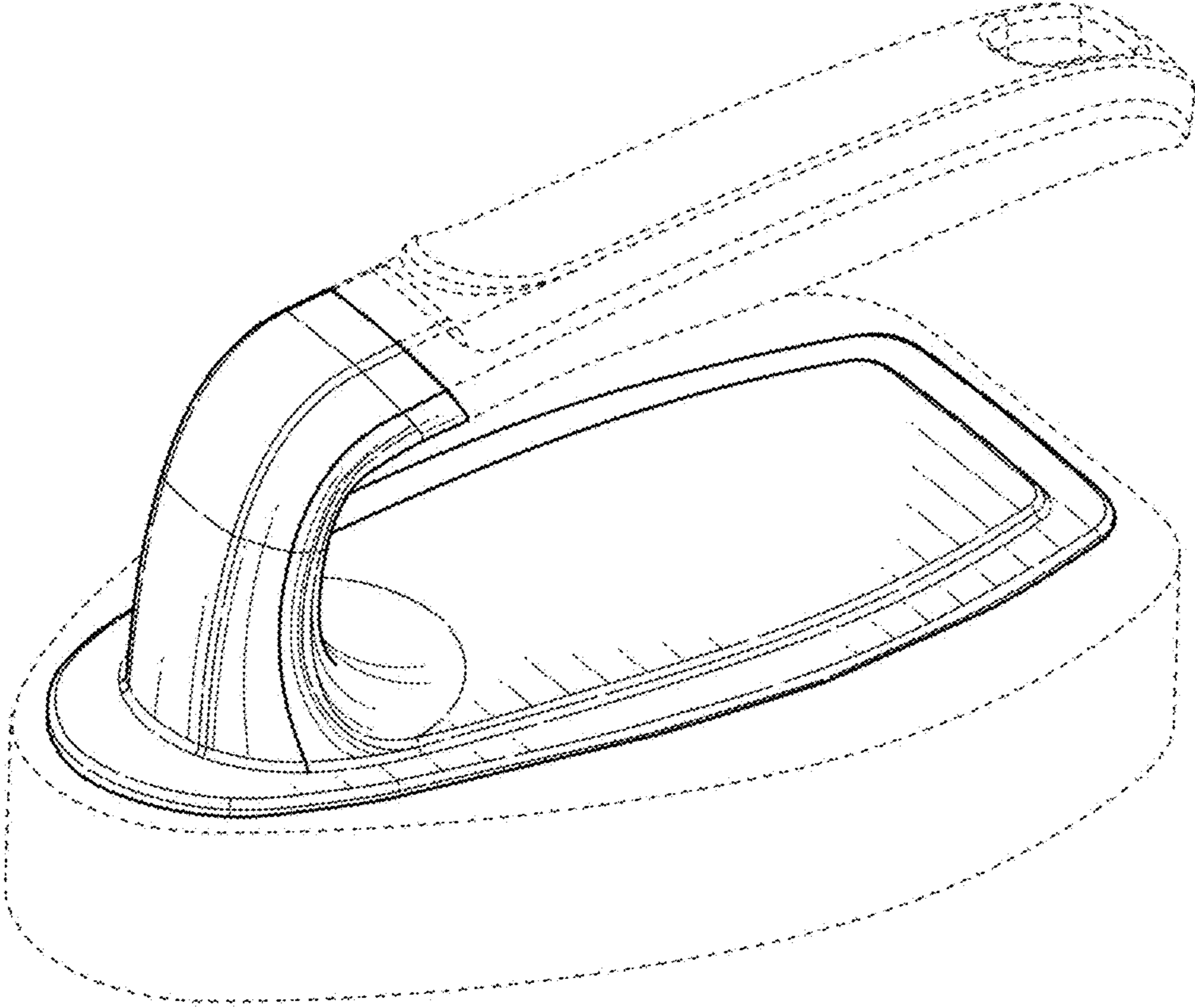

FIG. 1

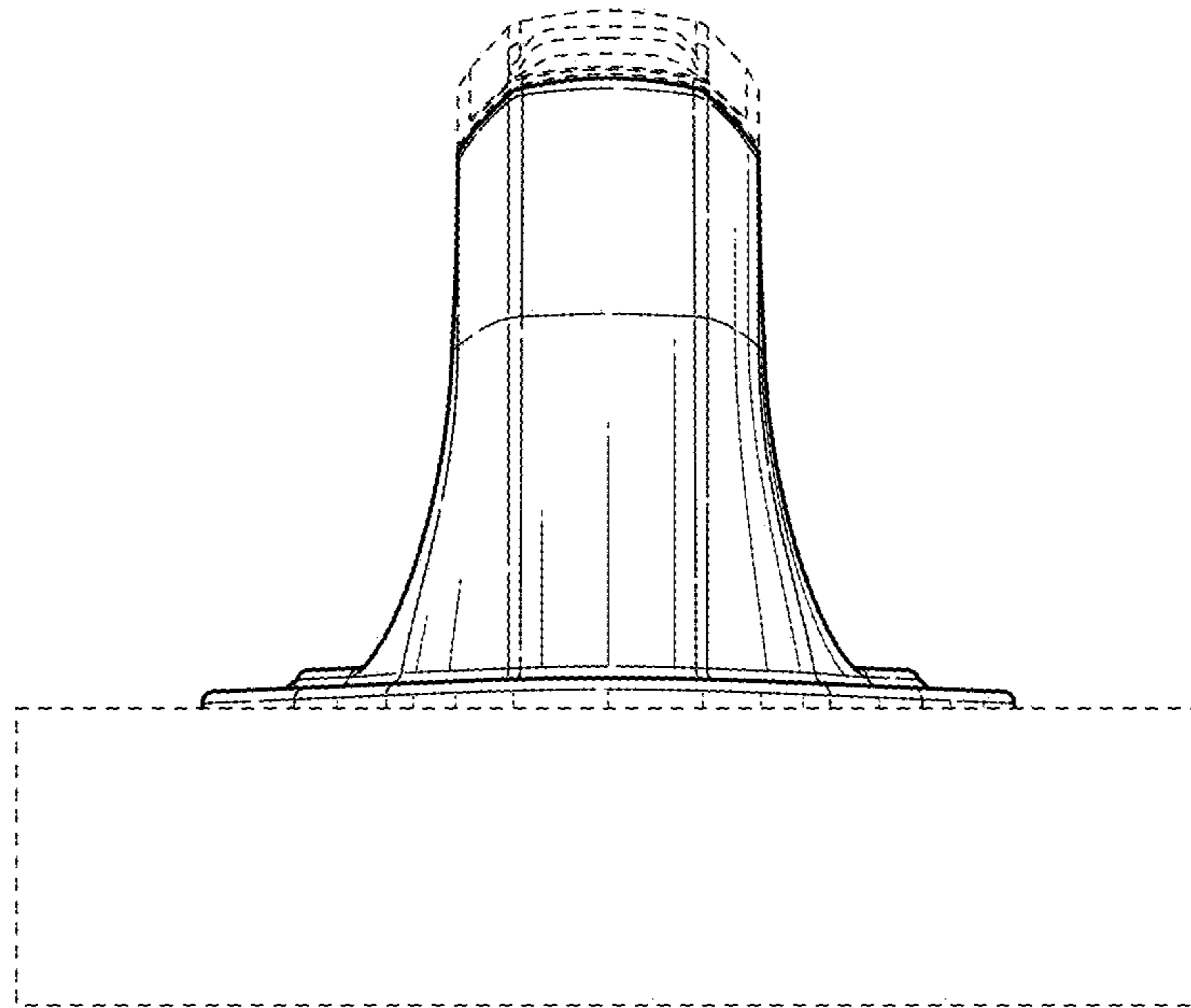

FIG. 2

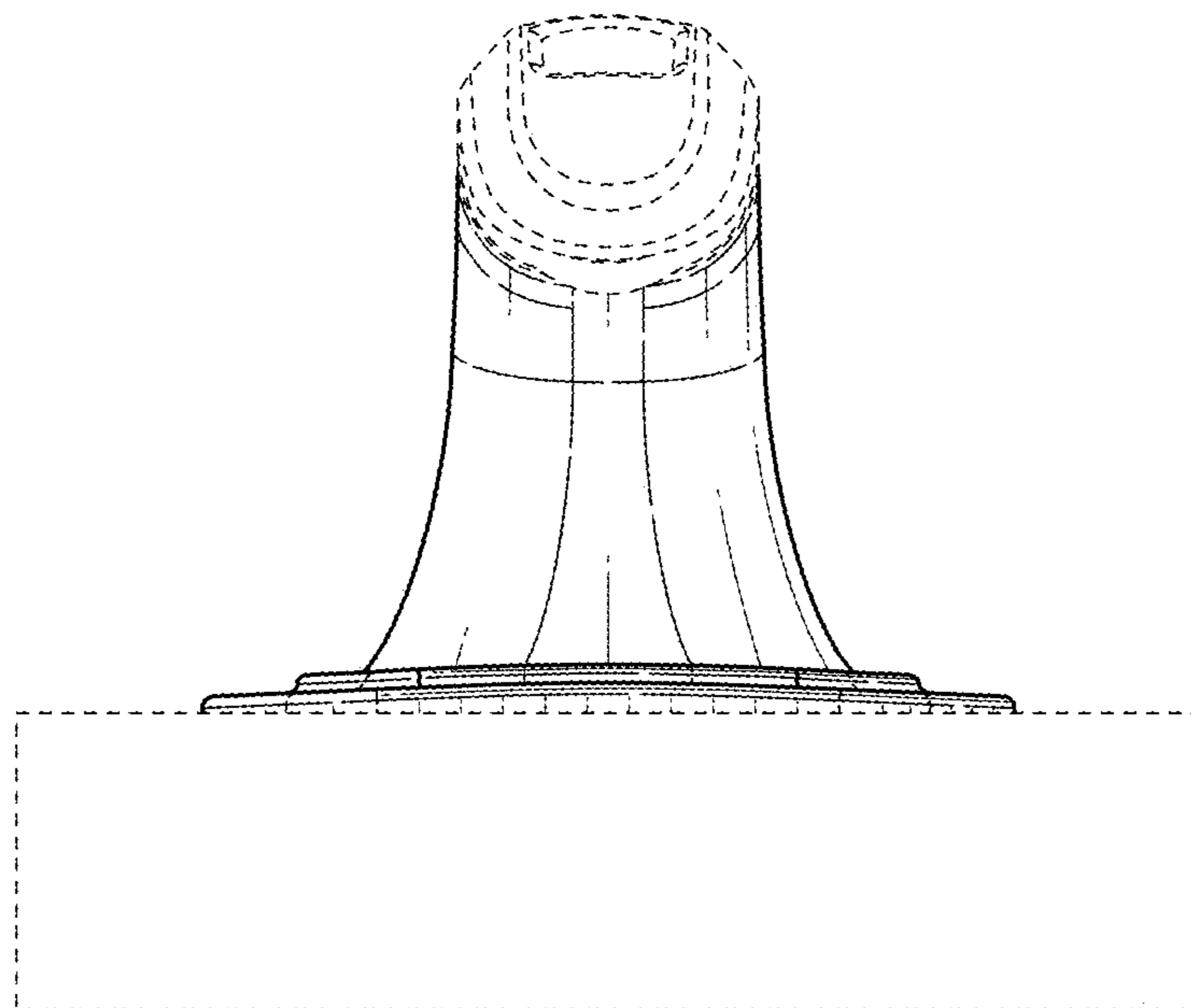

FIG. 3

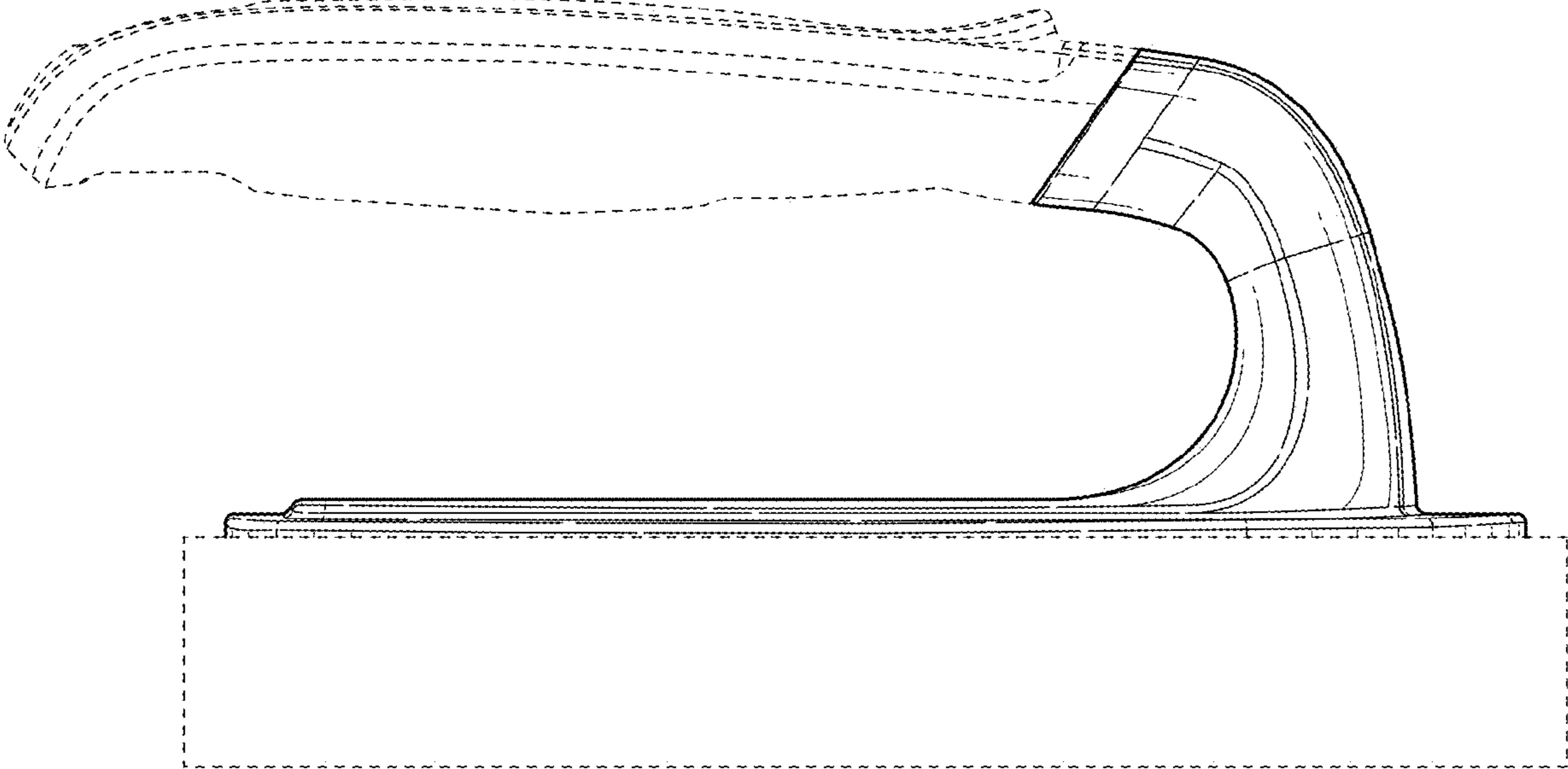

FIG. 4

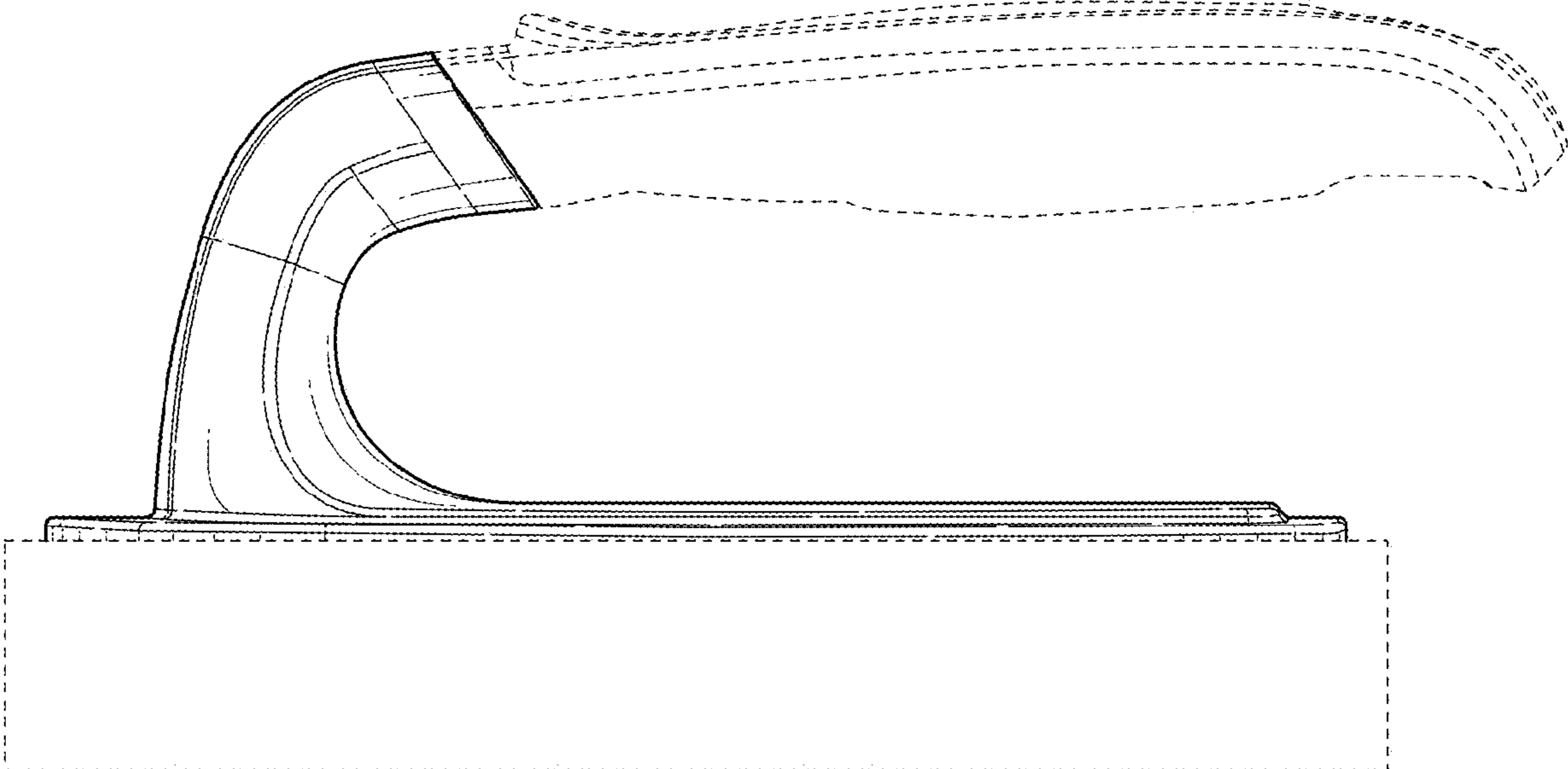

FIG. 5

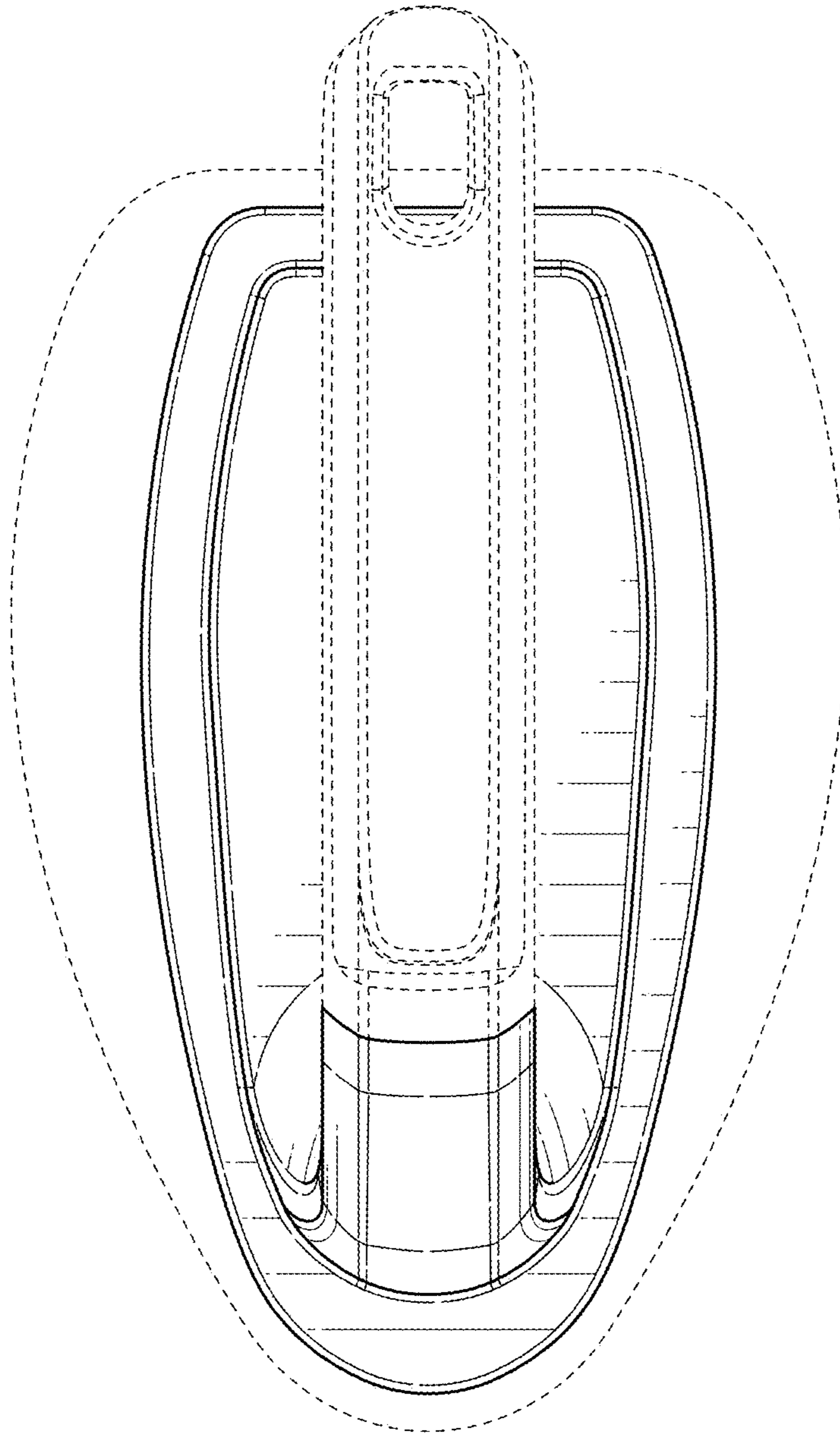

FIG. 6

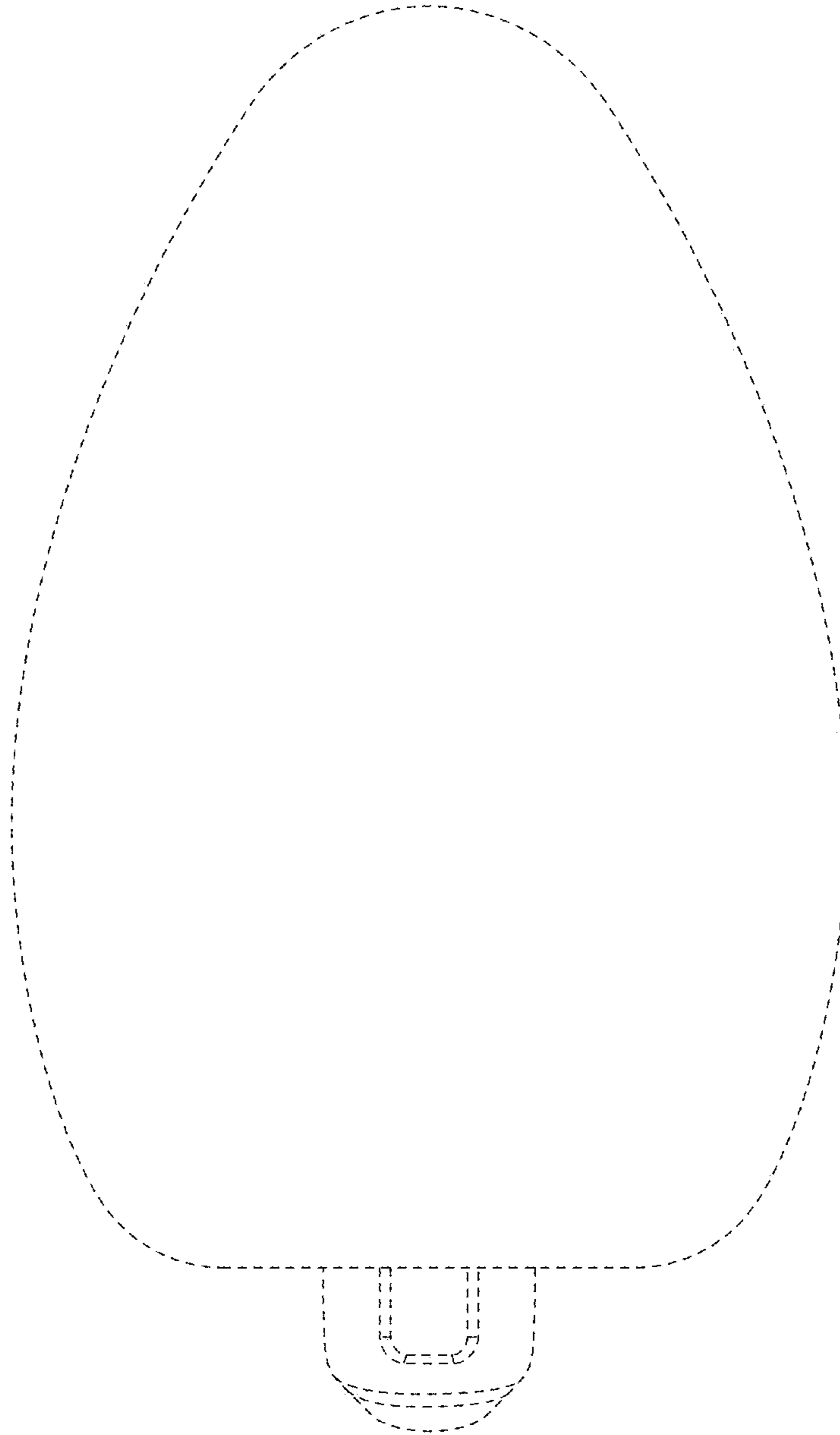

FIG. 7