



US00D922004S

(12) **United States Design Patent**
Wang et al.

(10) **Patent No.:** **US D922,004 S**
(45) **Date of Patent:** **** Jun. 8, 2021**

(54) **TOY FOR ANIMALS**

(56) **References Cited**

(71) Applicant: **Dongguan Vking Rubber Technology Co., Ltd.**, Dongguan (CN)

U.S. PATENT DOCUMENTS

(72) Inventors: **Yungao Wang**, Dongguan (CN);
Hongqiang Zhang, Dongguan (CN);
Guangwei Xie, Dongguan (CN)

D360,712 S *	7/1995	Bush	D24/191
D428,452 S *	7/2000	Aronov	D21/460
D483,822 S *	12/2003	Pelfrey	D21/712
D511,229 S *	11/2005	Byrne	D30/160
D537,492 S *	2/2007	Paolucci	D21/707
D579,157 S *	10/2008	Edwards	D21/707
D584,864 S *	1/2009	Matthews	D30/160
D600,414 S *	9/2009	Matthews	D30/160
D628,085 S *	11/2010	Hanak	D9/668
D639,868 S *	6/2011	Bower	D21/386
D692,970 S *	11/2013	Lien	D21/681
D816,280 S *	4/2018	Baker	D30/160
2008/0319357 A1 *	12/2008	Hey	A61H 39/04 601/15

(73) Assignee: **DONGGUAN VKING RUBBER TECHNOLOGY CO., LTD.**,
Dongguan (CN)

(**) Term: **15 Years**

(21) Appl. No.: **29/690,288**

* cited by examiner

(22) Filed: **May 7, 2019**

Primary Examiner — Aula Soroush

(51) **LOC (13) Cl.** **30-99**

(74) *Attorney, Agent, or Firm* — Shimokaji IP

(52) **U.S. Cl.**
USPC **D30/160**

(57) **CLAIM**

The ornamental design for a toy for animals, as shown.

(58) **Field of Classification Search**

DESCRIPTION

USPC D21/398, 400, 402, 412, 415, 426, 436,
D21/439, 440, 441, 443, 455, 479, 495,
D21/563, 656, 712, 713, 788, 799.1, 470,
D21/681, 386, 484, 707, 408, 437, 673,
D21/678, 679, 682; D24/211, 212, 214,
D24/215, 193–195; D1/120, 125–127,
D1/106; D30/158–160, 112, 119
CPC A01K 1/0356; A01K 5/01; A01K 5/0114;
A01K 15/025; A01K 39/0106; A01K
39/02; A01K 39/0213; A01K 7/02

FIG. 1 is a front elevation view of toy for animals showing our design;
FIG. 2 is a rear elevation view thereof;
FIG. 3 is a left side elevation view thereof;
FIG. 4 is a right side elevation view thereof;
FIG. 5 is a top plan view thereof;
FIG. 6 is a bottom plan view thereof; and,
FIG. 7 is a perspective view thereof.

See application file for complete search history.

1 Claim, 6 Drawing Sheets

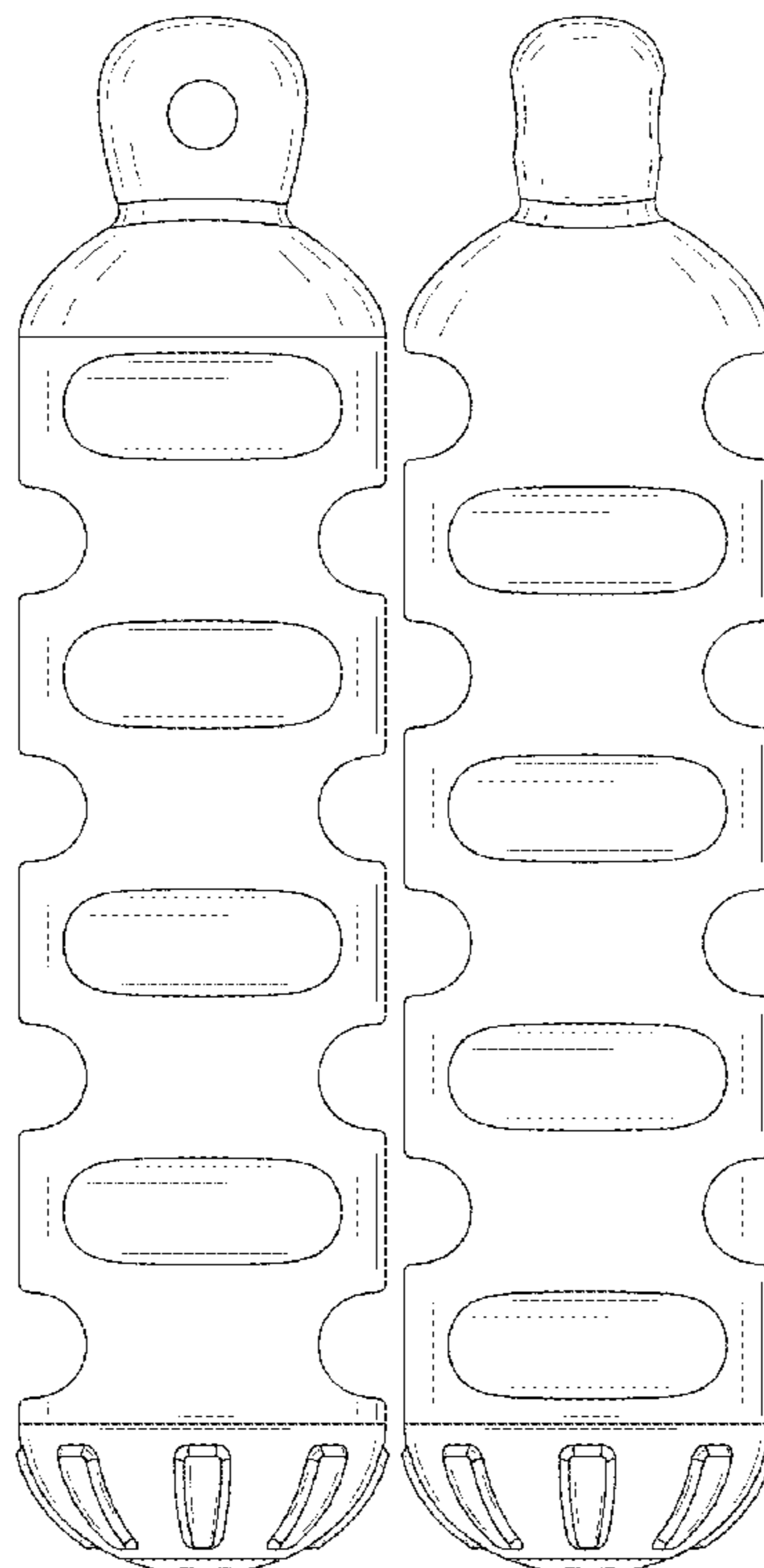

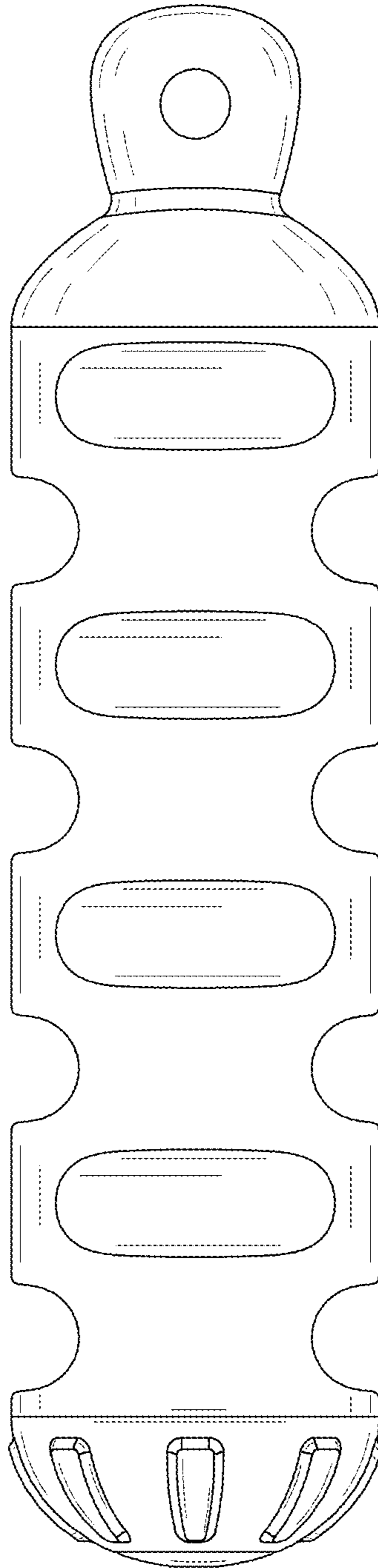

FIG. 1

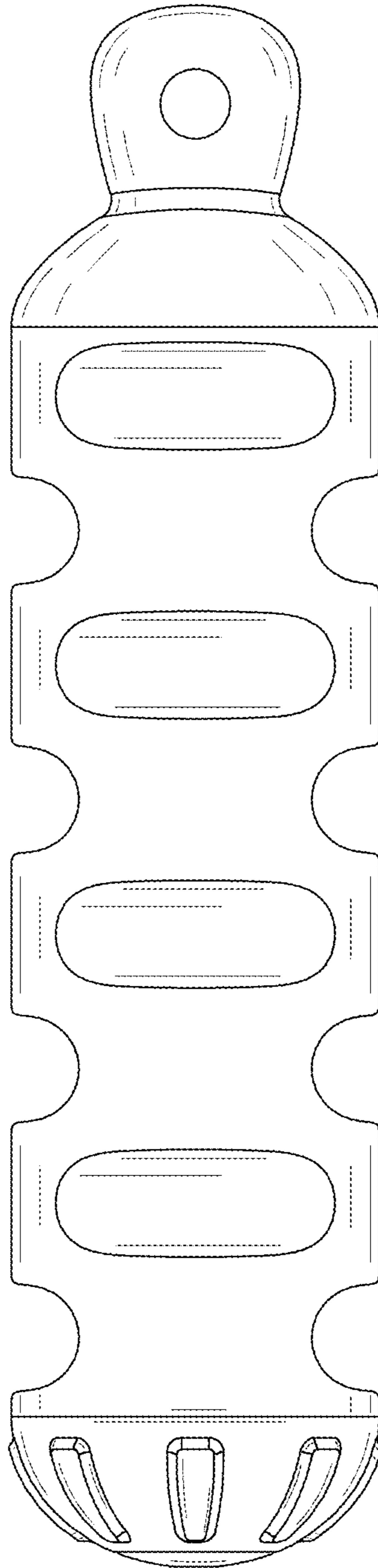

FIG.2

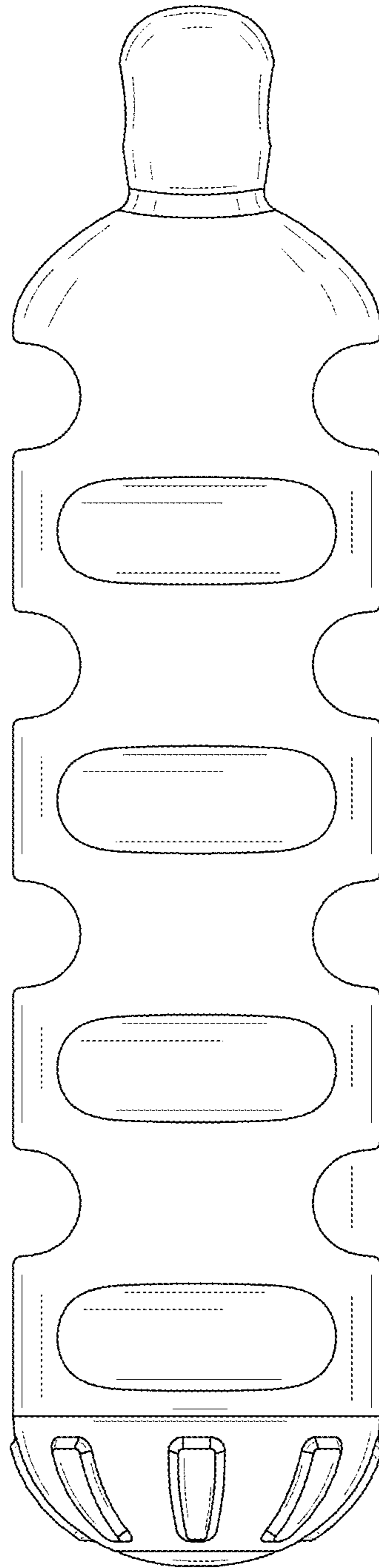

FIG.3

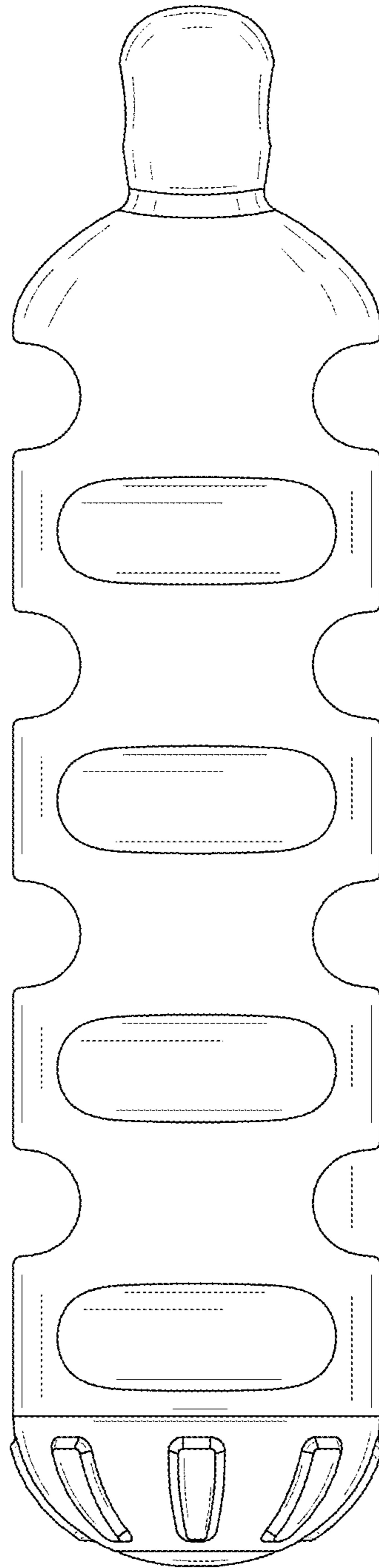

FIG.4

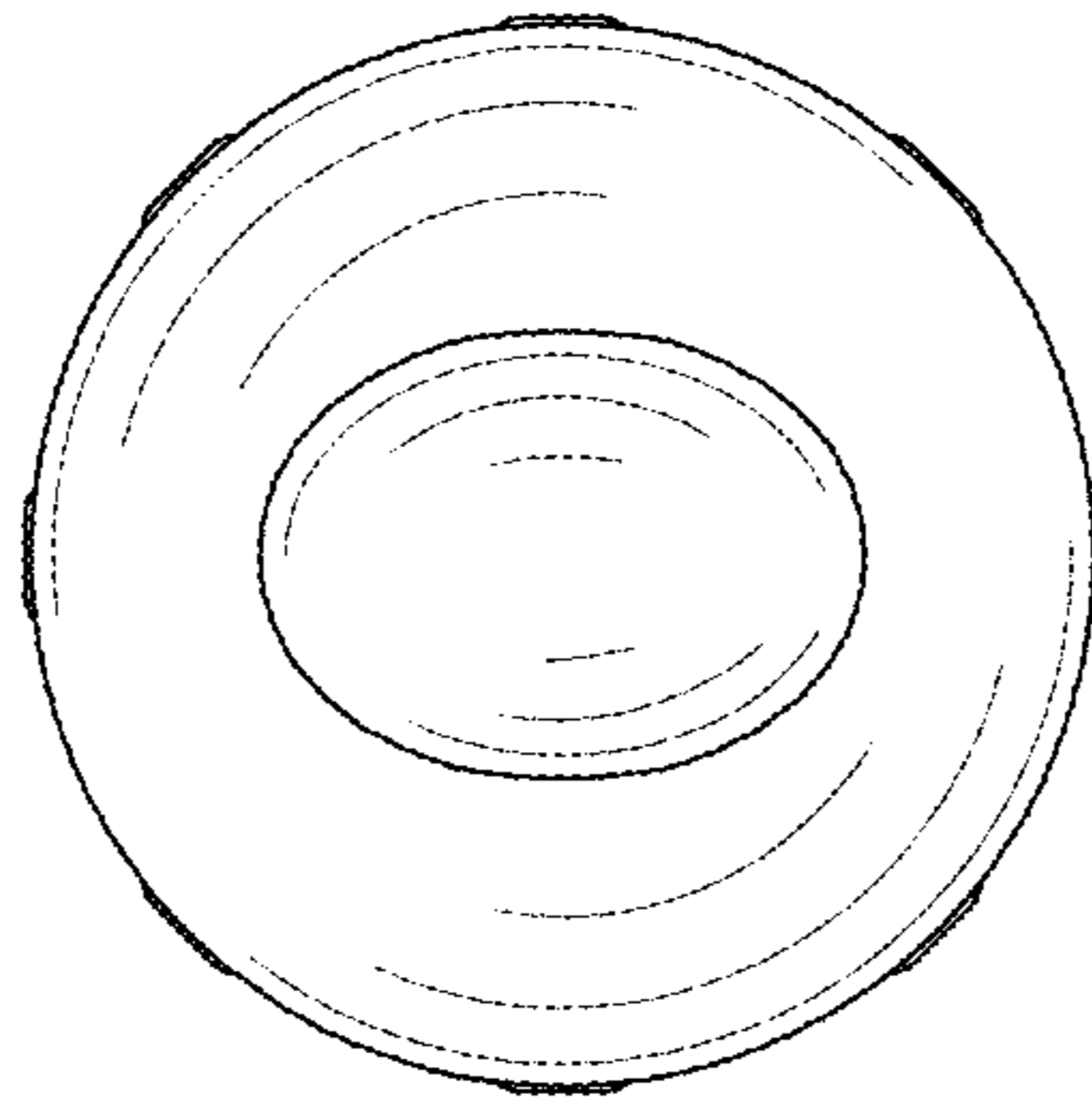

FIG. 5

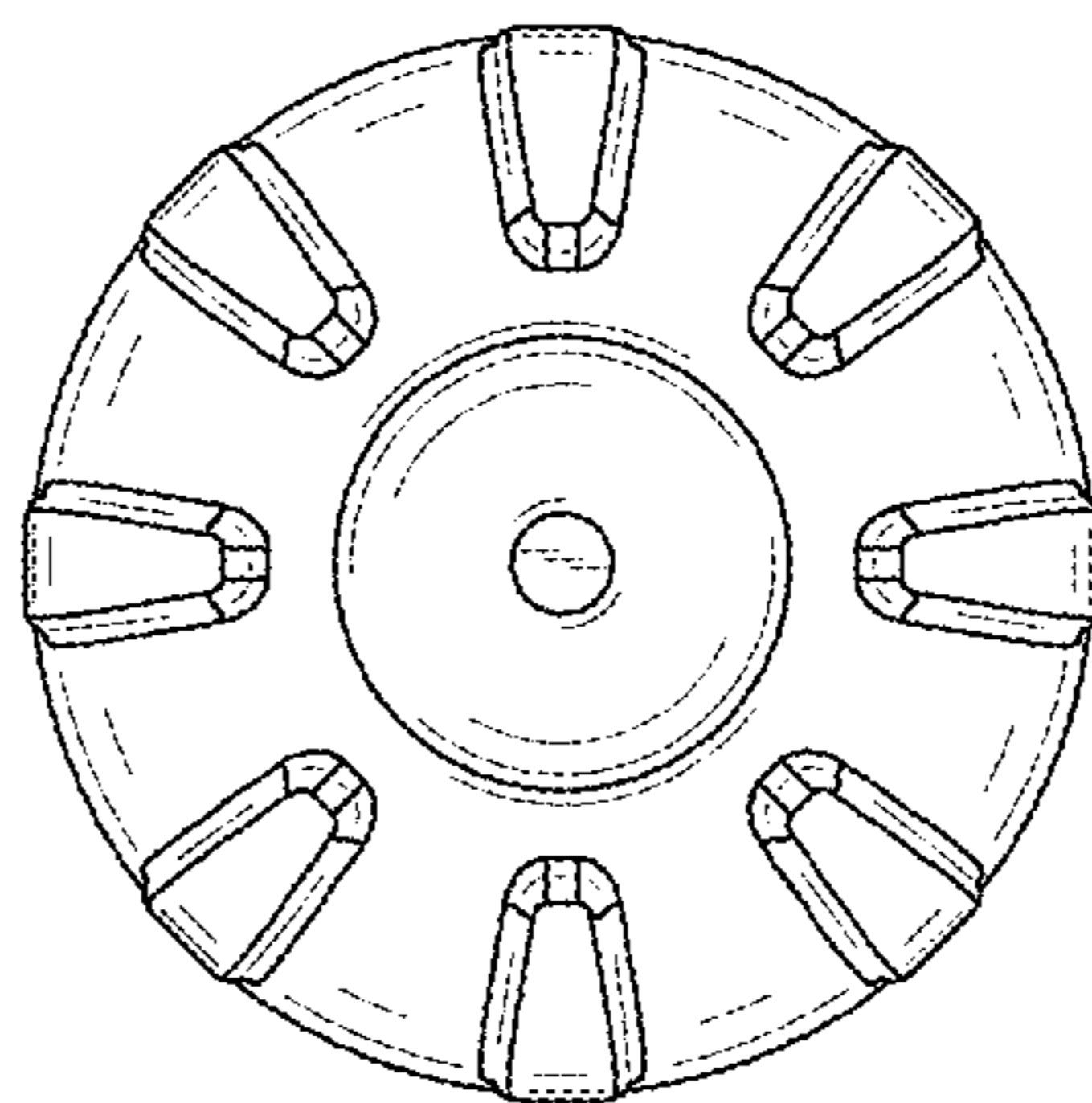

FIG. 6

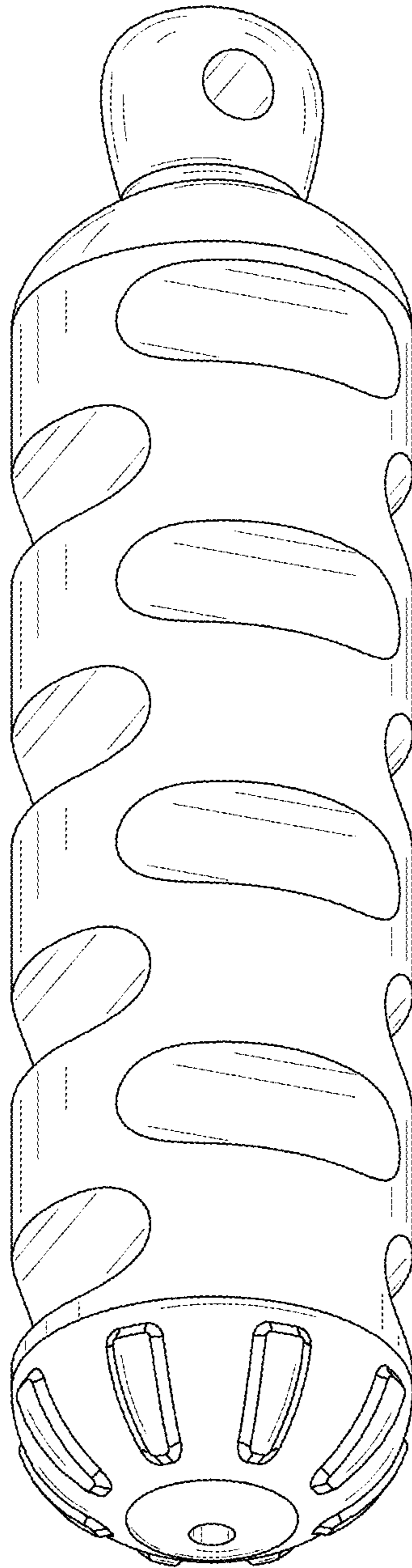

FIG.7