



US00D921980S

(12) **United States Design Patent**
Xu et al.

(10) **Patent No.:** **US D921,980 S**
(45) **Date of Patent:** **** Jun. 8, 2021**

- (54) **CHARGING CASE FOR AN ELECTRONIC CIGARETTE**
- (71) Applicant: **SHENZHEN RELX TECHNOLOGY CO., LTD.**, Shenzhen (CN)
- (72) Inventors: **Shengyang Xu**, Shenzhen (CN);
Yangyun Jin, Shenzhen (CN);
Qiukuan Xiang, Shenzhen (CN)
- (73) Assignee: **SHENZHEN RELX TECHNOLOGY CO., LTD.**, Shenzhen (CN)
- (**) Term: **15 Years**
- (21) Appl. No.: **29/719,684**
- (22) Filed: **Jan. 7, 2020**
- (51) **LOC (13) Cl.** **27-06**
- (52) **U.S. Cl.**
USPC **D27/172**
- (58) **Field of Classification Search**
USPC D27/172, 100, 101, 162–165, 174–176,
D27/183, 185–194; D24/110, 110.5;
D13/107–109
CPC A24F 47/002; A24F 47/006; A24F 47/008;
A61M 15/00; A61M 15/06
See application file for complete search history.

- D885,656 S * 5/2020 Clough D27/162
- D887,977 S * 6/2020 Weinstein H02J 7/0027
D13/108
- D902,476 S * 11/2020 Liu D27/162
(Continued)

OTHER PUBLICATIONS

Eye Glasses & Sunglasses Case by: Optiplix found on Amazon, Jan. 10, 2018 <https://www.amazon.com/Glasses-Shell-Protects-Stores-Eye-Wear/dp/B019DFPYFI>.*

Primary Examiner — Marissa J Cash
Assistant Examiner — Rebecca Tsehaye
(74) *Attorney, Agent, or Firm* — Idea Intellectual Limited; Margaret A. Burke; Sam T. Yip

(57) **CLAIM**

The ornamental design for a charging case for an electronic cigarette, as shown and described.

DESCRIPTION

FIG. 1 is a perspective view of a charging case for an electronic cigarette in a closed position;
FIG. 2 is a front view thereof;
FIG. 3 is a rear view thereof;
FIG. 4 is a left view thereof;
FIG. 5 is a right view thereof;
FIG. 6 is a top view thereof;
FIG. 7 is a bottom view thereof;
FIG. 8 is a perspective view of a charging case for an electronic cigarette in an open position;
FIG. 9 is a front view thereof;
FIG. 10 is a rear view thereof;
FIG. 11 is a left view thereof;
FIG. 12 is a right view thereof;
FIG. 13 is a top view thereof; and,
FIG. 14 is a bottom view thereof.
The broken lines in the drawings depict portions of the charging case for an electronic cigarette that form no part of the claimed design.

(56) **References Cited**

U.S. PATENT DOCUMENTS

- D410,765 S * 6/1999 Gawryk D27/183
- D731,178 S * 6/2015 Gorouvein D3/265
- D742,492 S * 11/2015 Robinson D23/360
- D800,380 S * 10/2017 Williams D27/163
- D810,431 S * 2/2018 Kim D3/266
- D824,504 S * 7/2018 Williams D23/360
- D834,248 S * 11/2018 Cordani D27/172
- D870,369 S * 12/2019 Greenbaum D27/162
- D872,853 S * 1/2020 Stuart D24/110
- D876,004 S * 2/2020 Wang D27/101

1 Claim, 8 Drawing Sheets

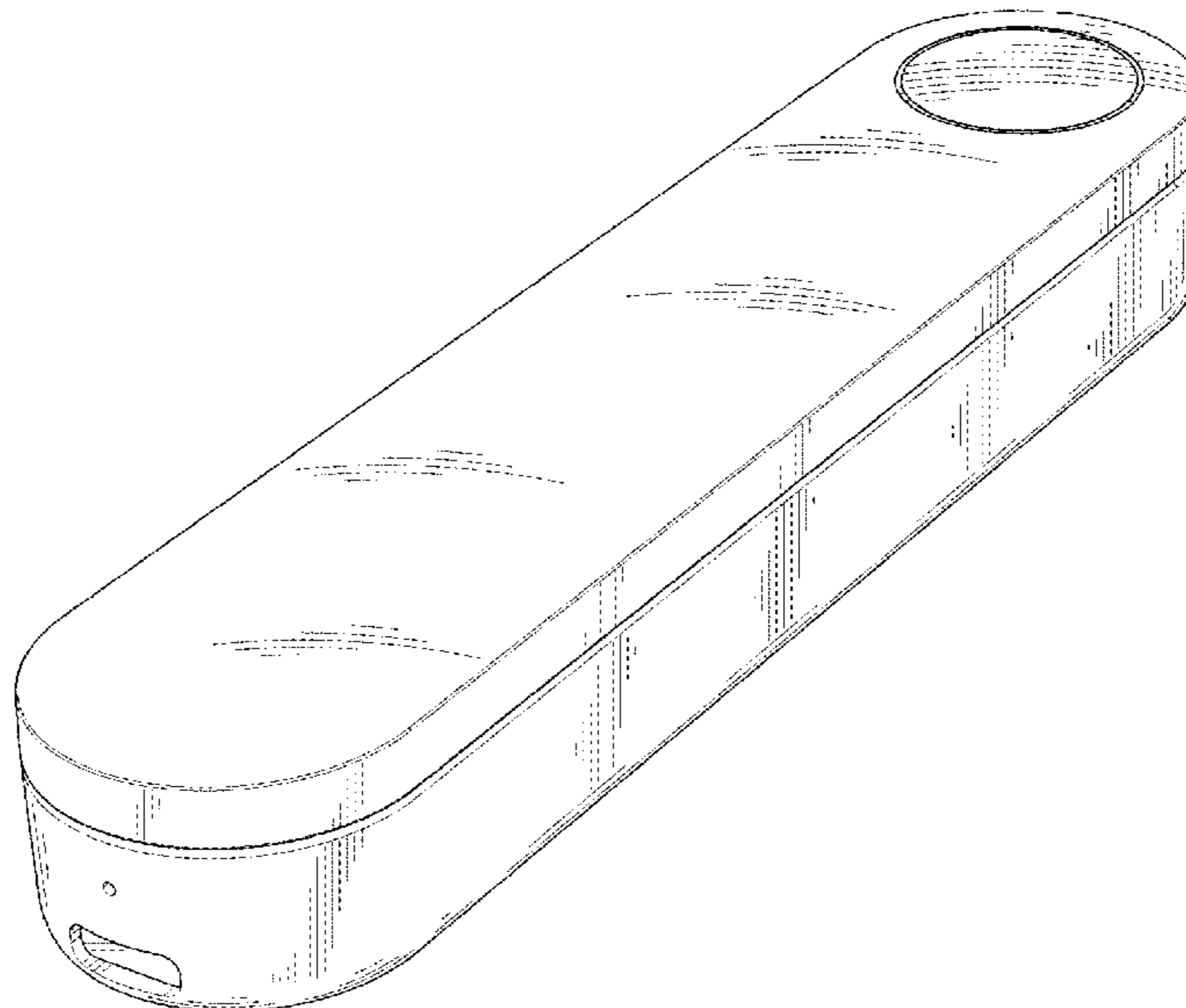

(56)

References Cited

U.S. PATENT DOCUMENTS

D903,191 S * 11/2020 Li D27/101
2015/0128967 A1 * 5/2015 Robinson A24F 47/008
131/328

* cited by examiner

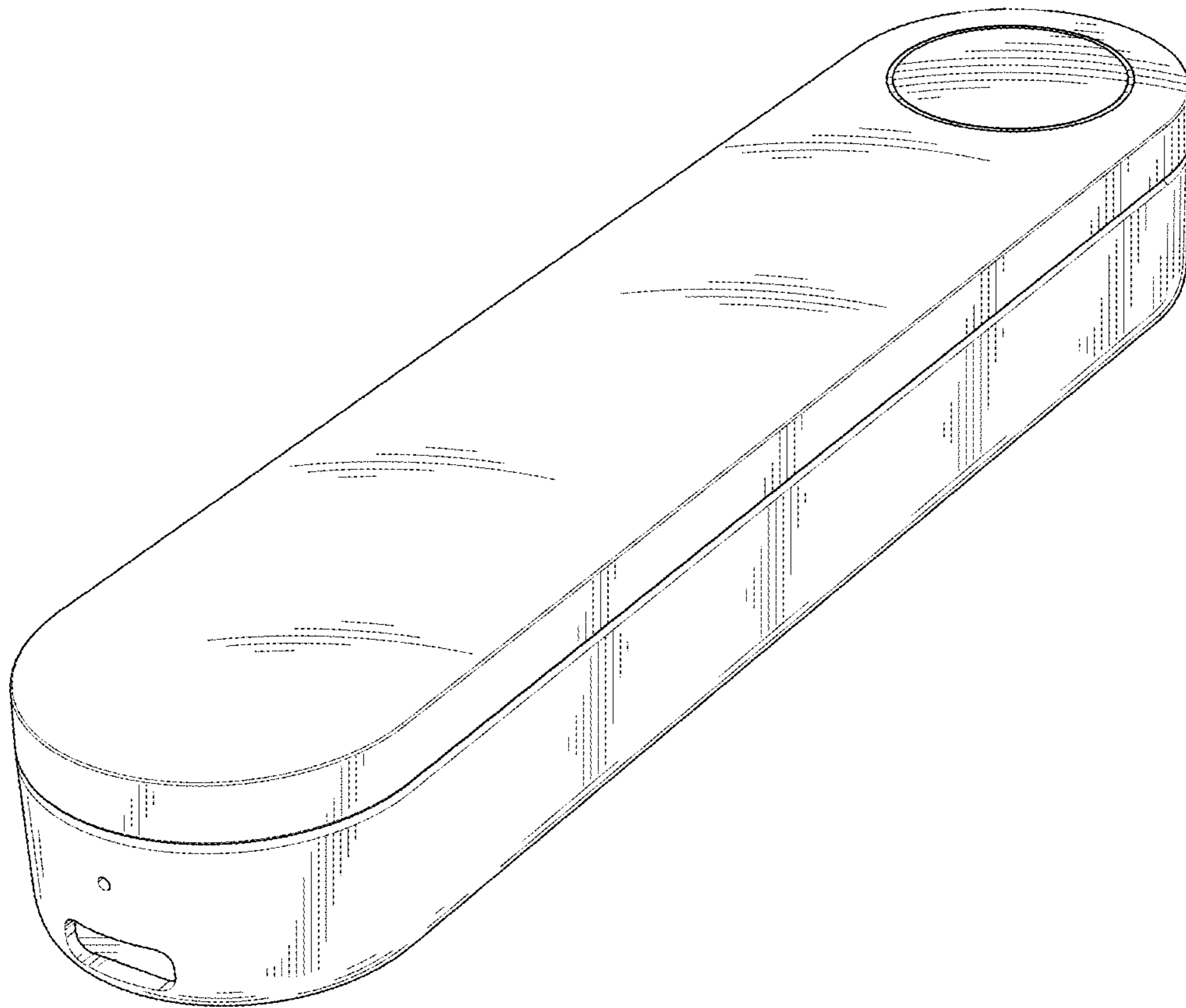

FIG. 1

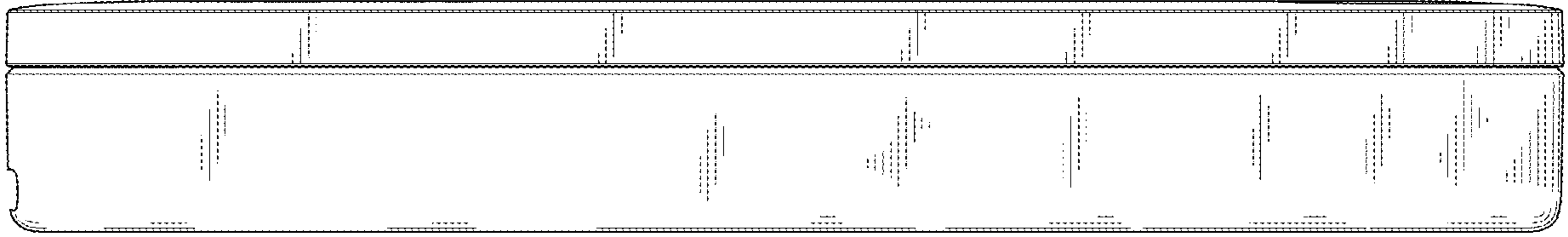

FIG. 2

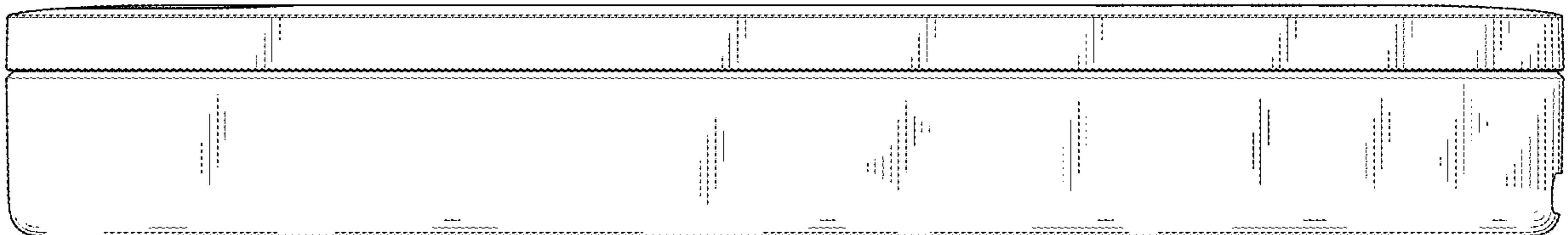

FIG. 3

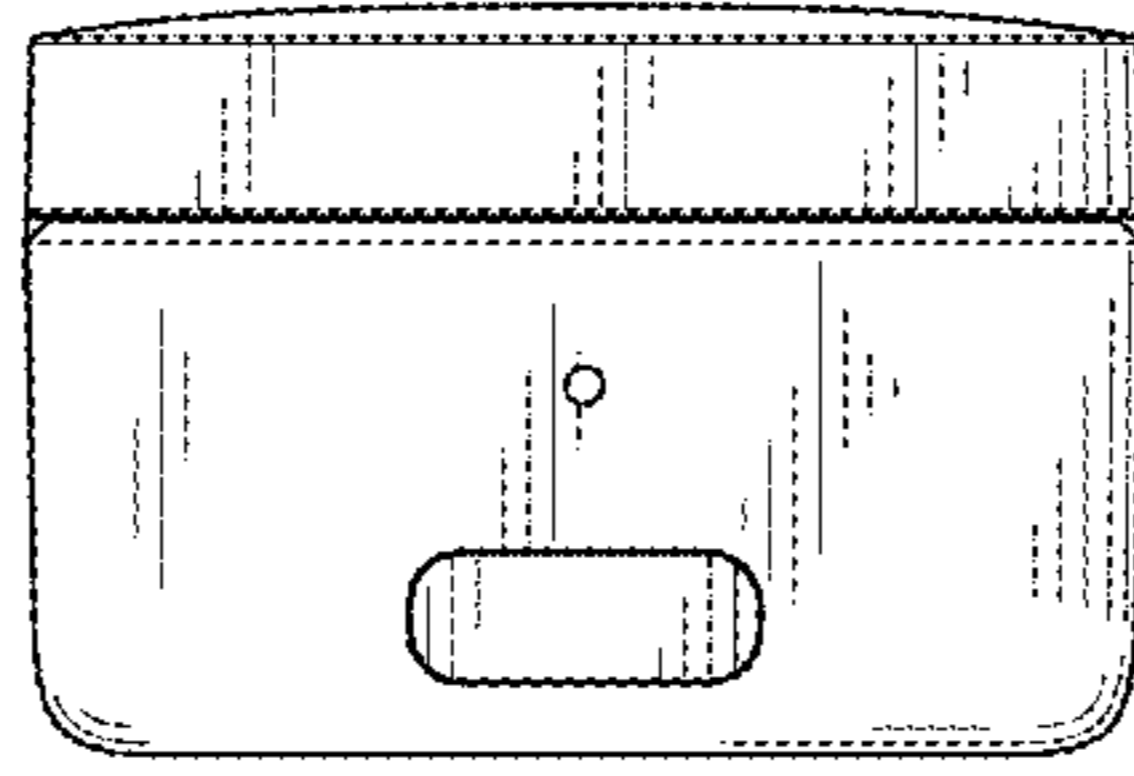

FIG. 4

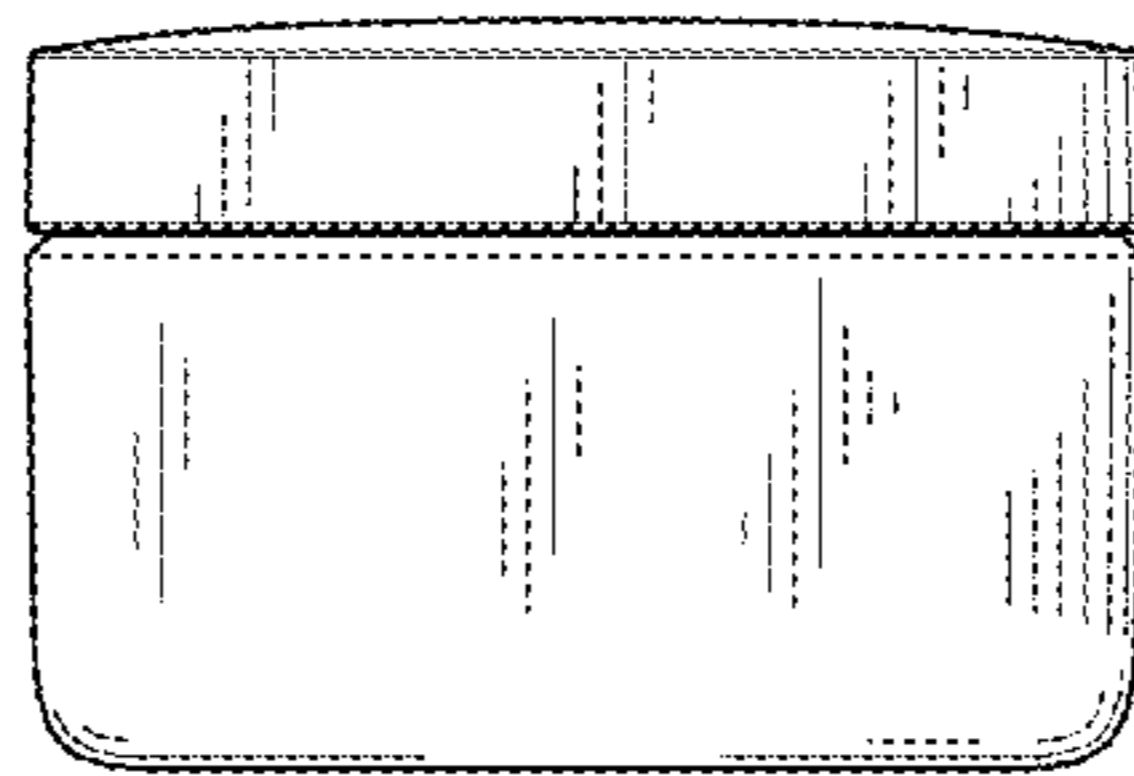

FIG. 5

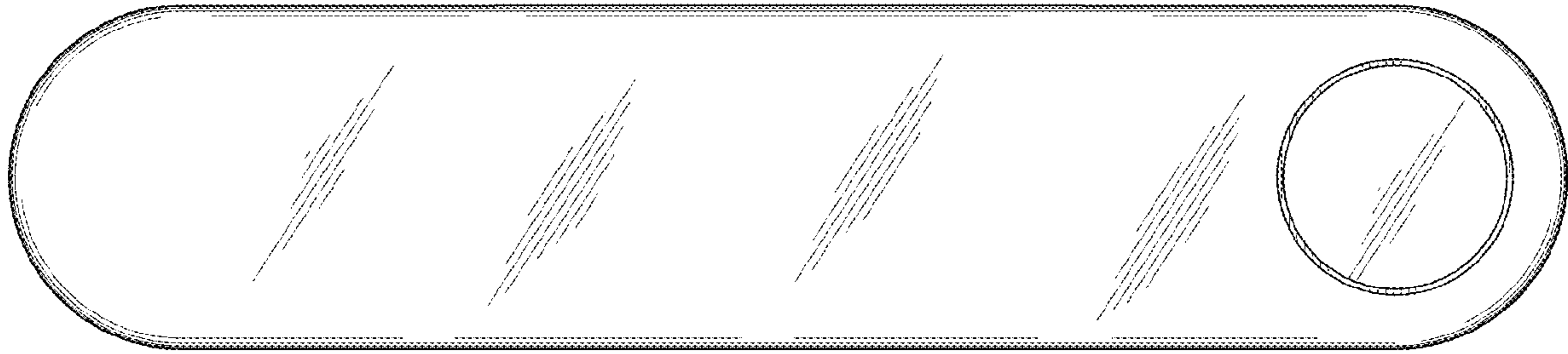

FIG. 6

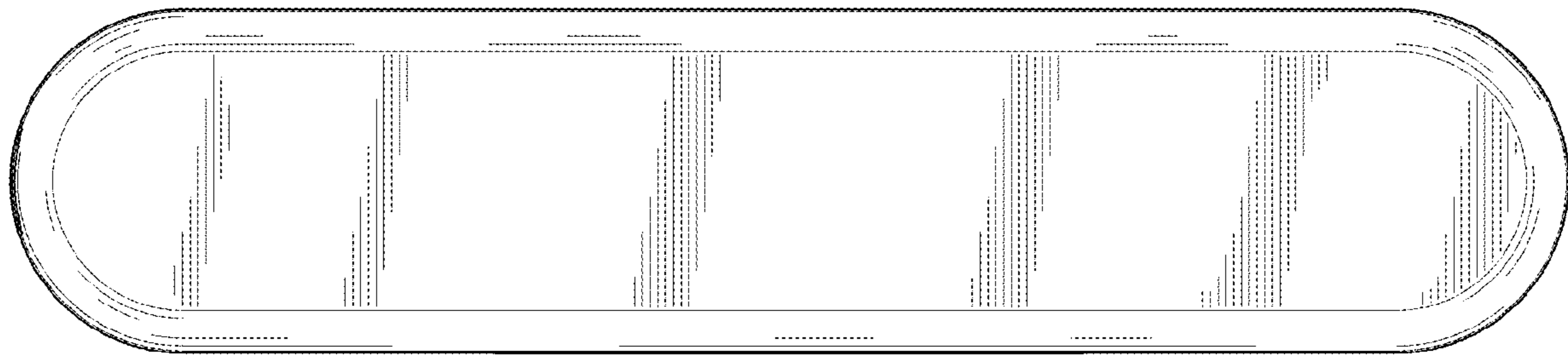

FIG. 7

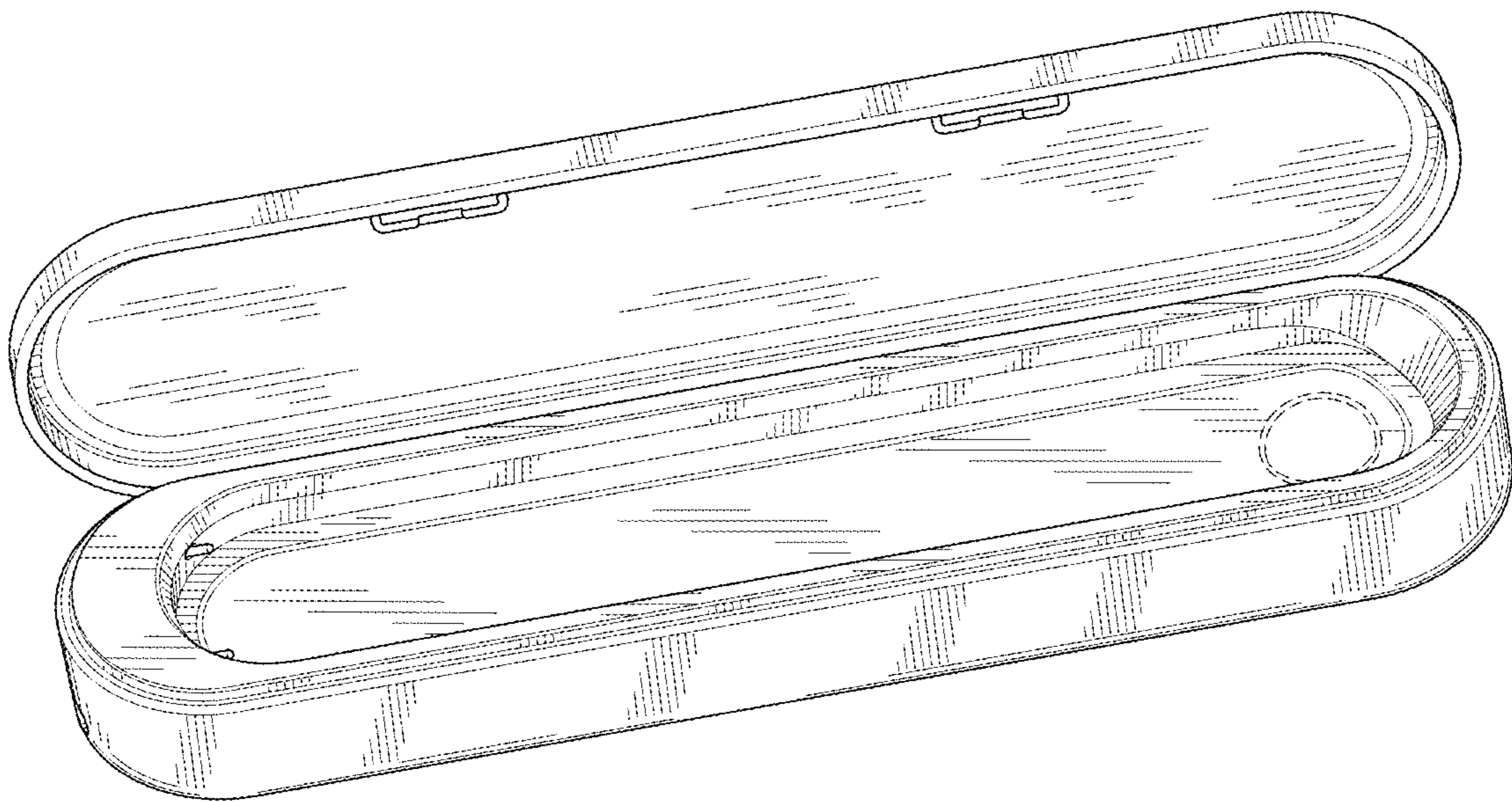

FIG. 8

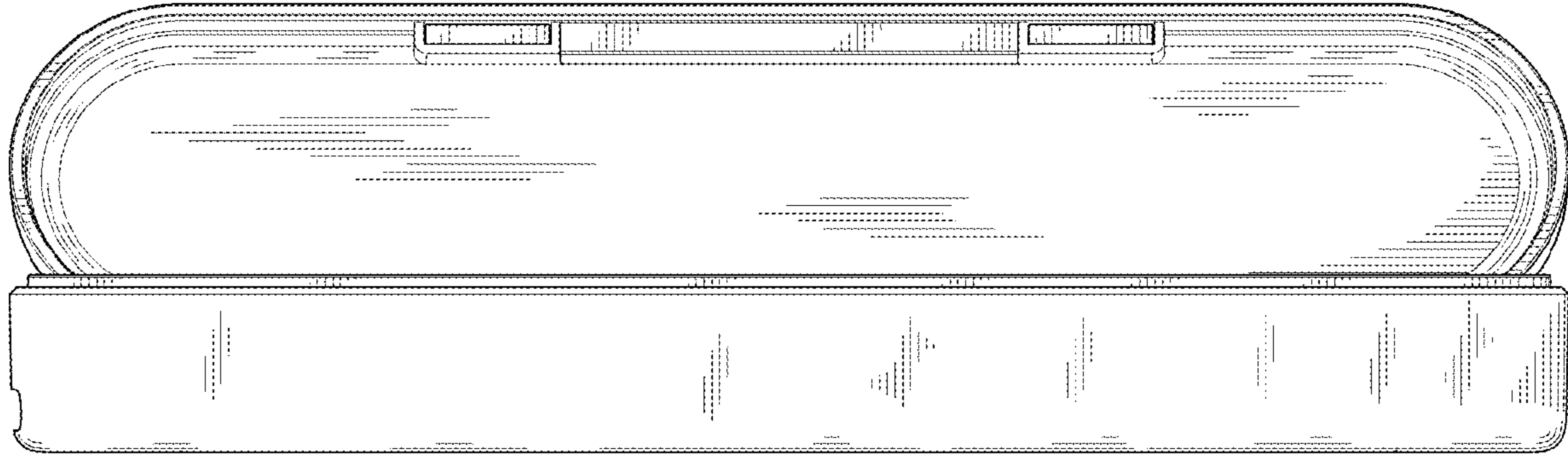

FIG. 9

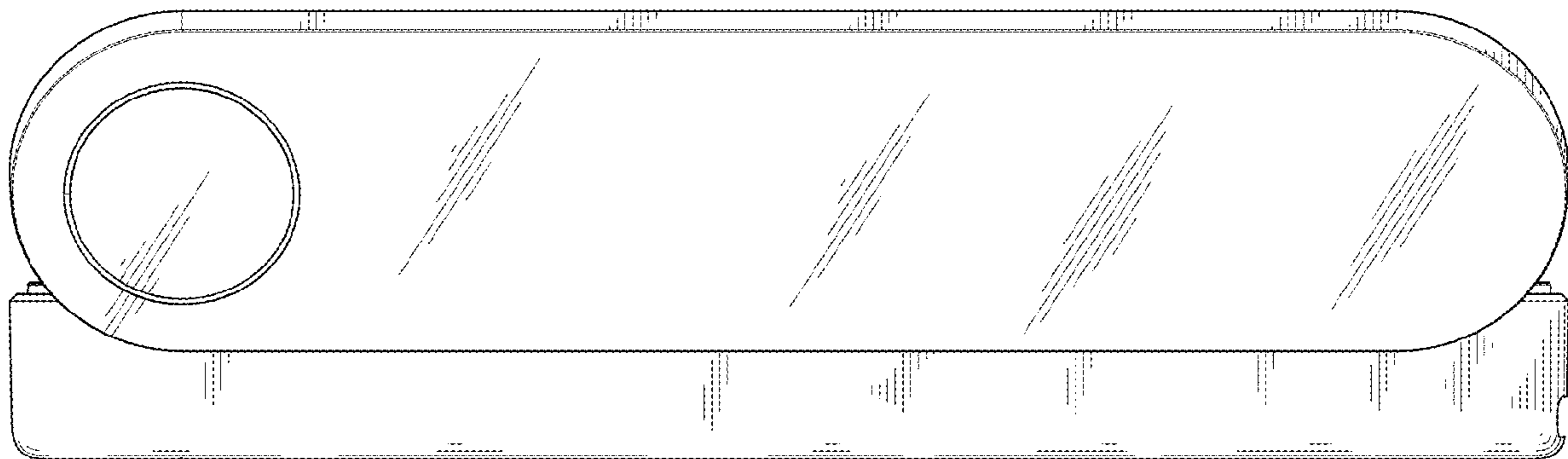

FIG. 10

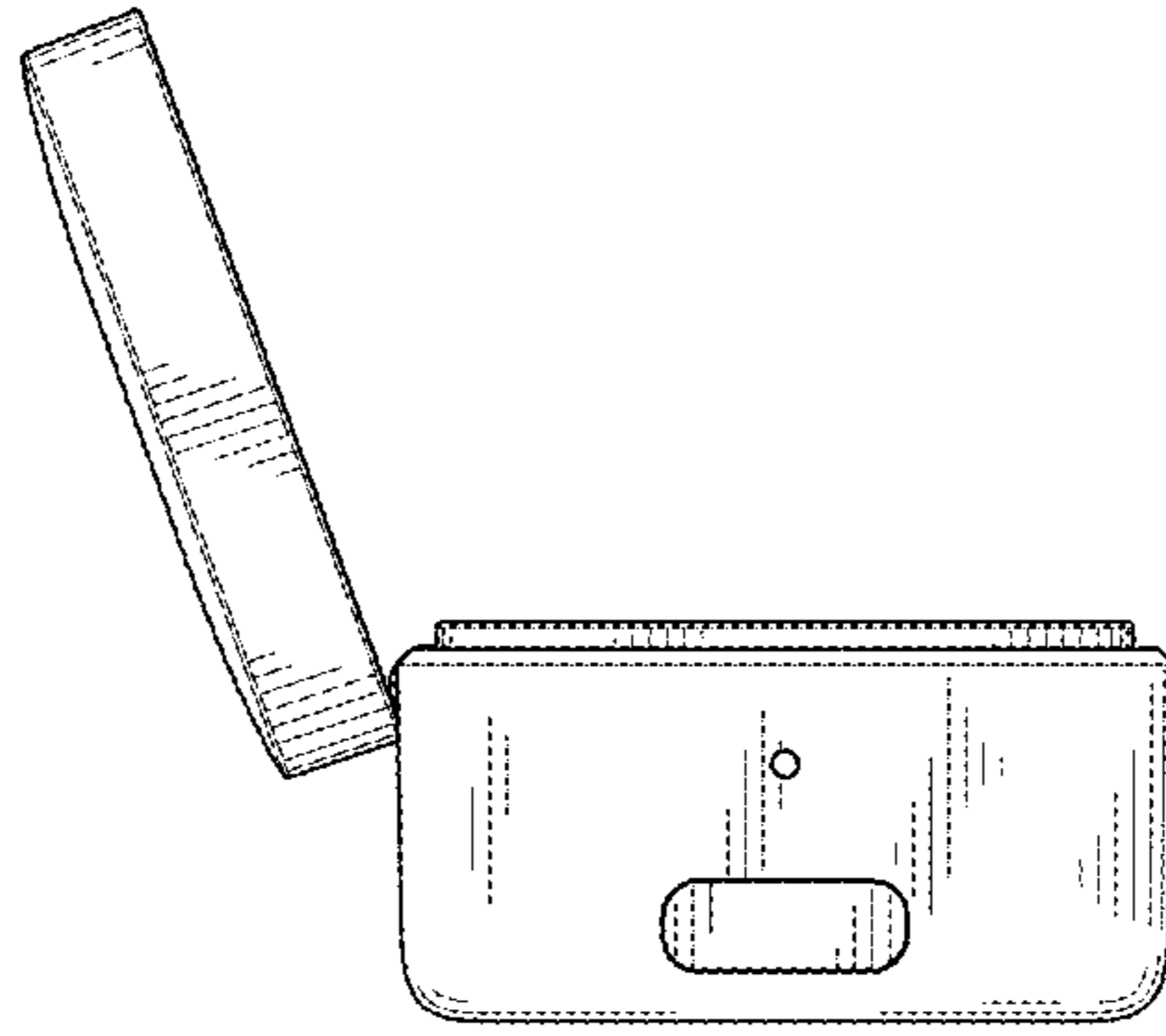

FIG. 11

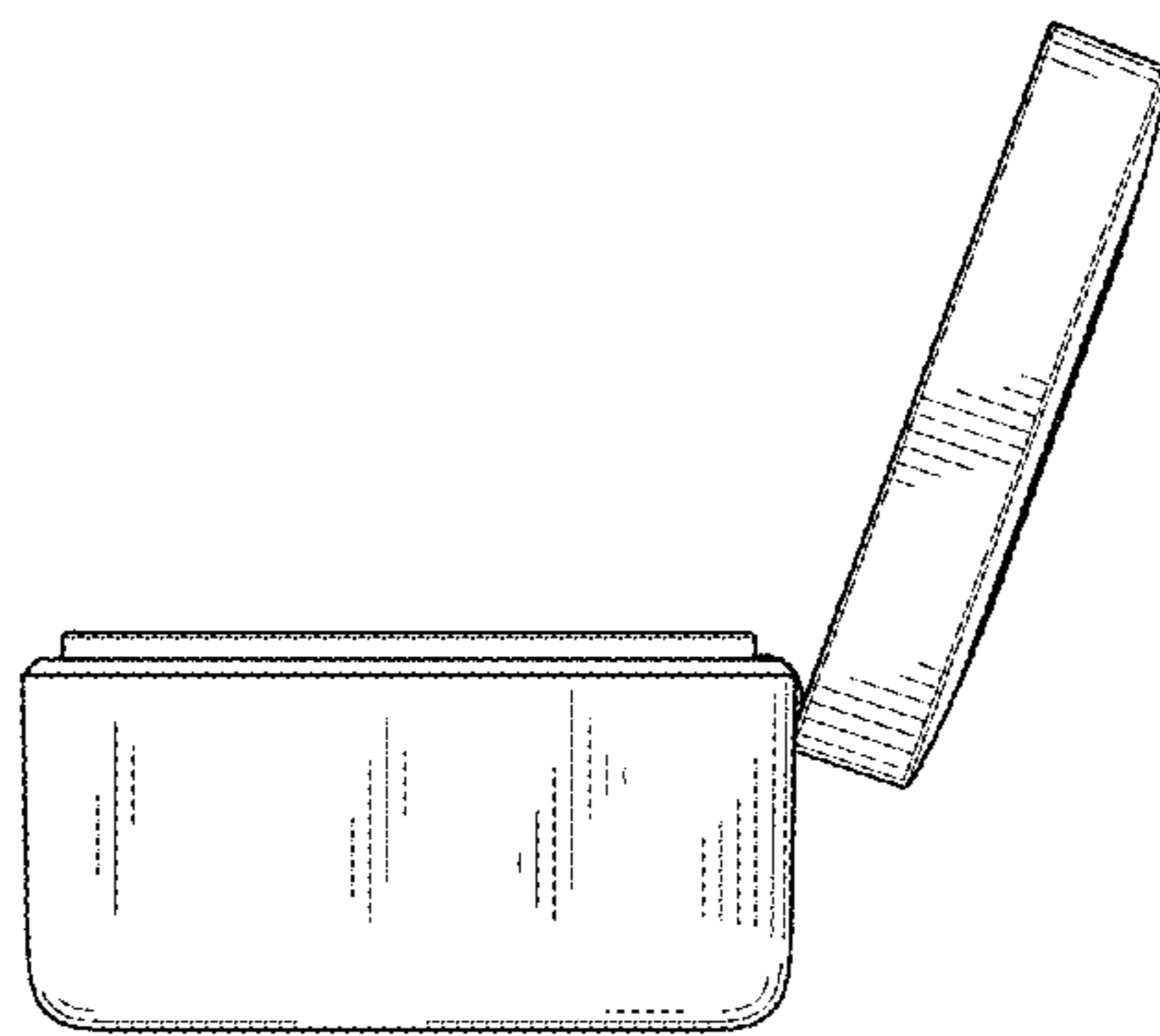

FIG. 12

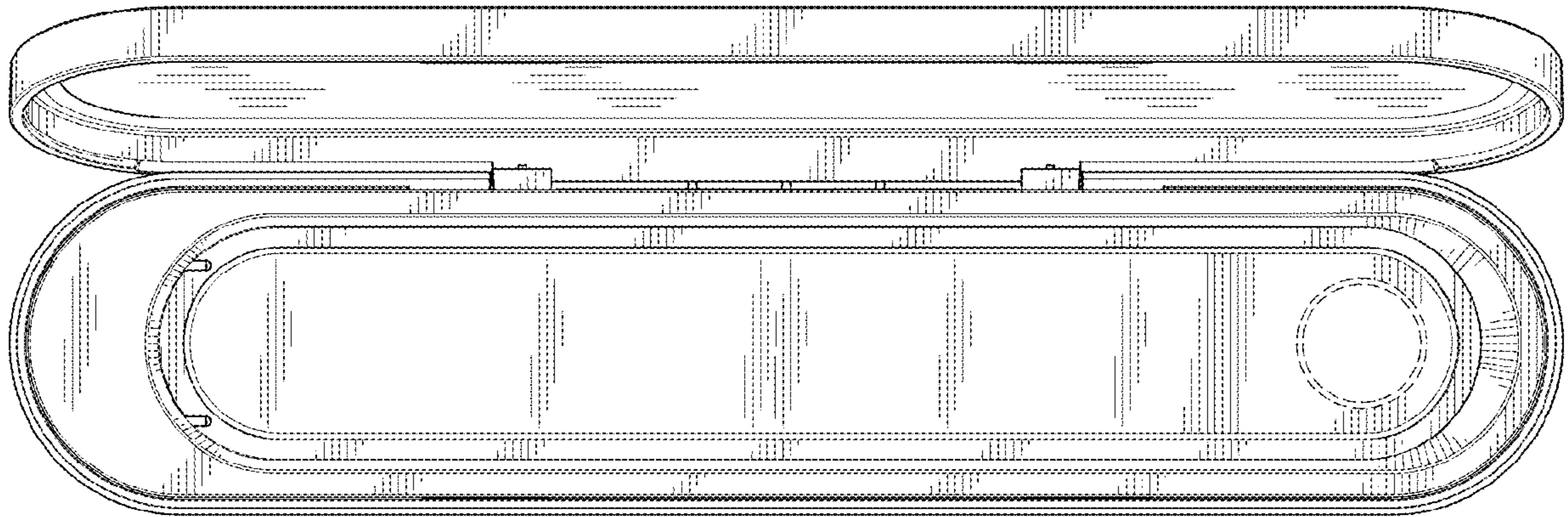

FIG. 13

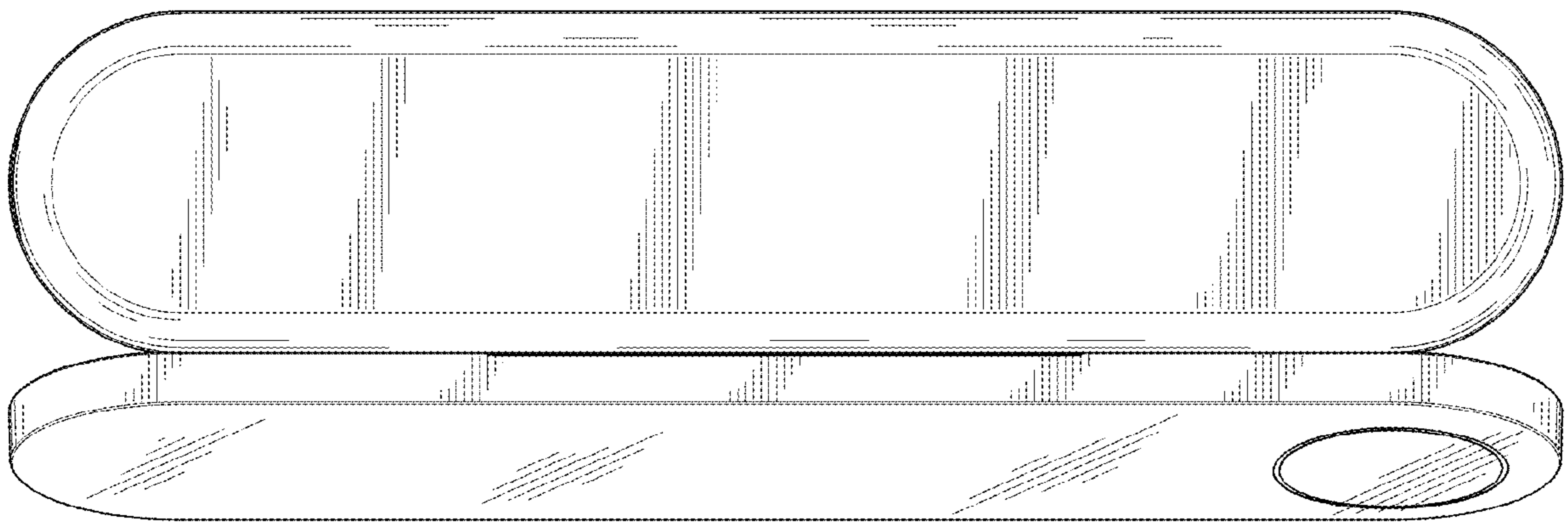

FIG. 14