



US00D921890S

(12) **United States Design Patent**  
**Milella, Jr. et al.**

(10) **Patent No.:** **US D921,890 S**  
(45) **Date of Patent:** **\*\* Jun. 8, 2021**

- (54) **MINI AXIAL HANDLE FOR SURGICAL TOOLS**
- (71) Applicant: **ECA Medical Instruments, Inc.**,  
Newbury Park, CA (US)
- (72) Inventors: **Michael J Milella, Jr.**, Thousand Oaks,  
CA (US); **Lane Aaron Hale**, Thousand  
Oaks, CA (US)
- (73) Assignee: **ECA Medical Instruments, Inc.**,  
Newbury Park, CA (US)
- (\*\*) Term: **15 Years**
- (21) Appl. No.: **29/713,228**
- (22) Filed: **Nov. 14, 2019**
- (51) **LOC (13) Cl.** ..... **24-02**
- (52) **U.S. Cl.**  
USPC ..... **D24/133**
- (58) **Field of Classification Search**  
USPC ..... D24/108, 112, 113, 114, 115, 116, 117,  
D24/127, 133, 134, 136, 137, 138, 143,  
D24/145, 200, 144, 147; D8/14, 16, 19,  
D8/21, 82, 83, 84, 85, 86, 107, 34, 300,  
D8/303, 314, 372, 374, 394, 77, 17, 22,  
D8/23, 24, 25, 26, 27, 28, 29, 52, 55, 81,  
D8/87, 102, 103, 104, 105, 106, 98, 99,  
D8/93, 94  
CPC .... A61M 25/0136; A61B 17/00; A61B 17/62;  
A61B 17/64; A61B 17/645; A47J 43/26;  
B25B 13/463; B25B 13/468; B25B 15/04;  
B25G 1/005; B25G 1/085  
See application file for complete search history.

(56) **References Cited**

**U.S. PATENT DOCUMENTS**

- D100,612 S \* 8/1936 Bryant ..... D8/83
- D133,782 S \* 9/1942 Pfeiffer ..... D8/82

- 2,884,972 A \* 5/1959 Harris ..... B25B 15/04  
81/29
- 3,343,577 A \* 9/1967 Wagner ..... B25B 15/04  
81/177.1
- D229,475 S \* 12/1973 Uboldi ..... D8/82
- D305,723 S \* 1/1990 Wilson ..... D8/82
- D312,033 S \* 11/1990 Carlson ..... D8/82
- D314,497 S \* 2/1991 Symiczek ..... D8/14
- D360,344 S \* 7/1995 Eggert ..... D8/83
- D363,868 S \* 11/1995 Israel ..... D8/83
- D375,669 S \* 11/1996 Shiao ..... D8/107
- D376,204 S \* 12/1996 Huculak ..... D24/133
- D382,188 S \* 8/1997 Lin ..... D8/83
- D383,660 S \* 9/1997 Anderson ..... D8/107
- D384,263 S \* 9/1997 Lin ..... D8/107
- D384,565 S \* 10/1997 Lin ..... D8/107
- D386,063 S \* 11/1997 Badiali ..... D8/107
- D393,318 S \* 4/1998 Wolter ..... D24/133

(Continued)

*Primary Examiner* — T Chase Nelson

*Assistant Examiner* — Kelly L Gross

(74) *Attorney, Agent, or Firm* — Ferguson Case Orr  
Paterson

(57) **CLAIM**

The ornamental design for a mini axial handle for surgical tools, as shown and described.

**DESCRIPTION**

FIG. 1 is a top, front, right-side perspective view of a mini axial handle for surgical tools showing the new design.  
 FIG. 2 is a front elevation view thereof.  
 FIG. 3 is a rear elevation view thereof.  
 FIG. 4 is a left side elevation view thereof.  
 FIG. 5 is a right side elevation view thereof.  
 FIG. 6 is a top plan view thereof; and,  
 FIG. 7 is a bottom plan view thereof.  
 The broken lines in the drawings are included to show portions of the article that form no part of the claimed design.

**1 Claim, 3 Drawing Sheets**

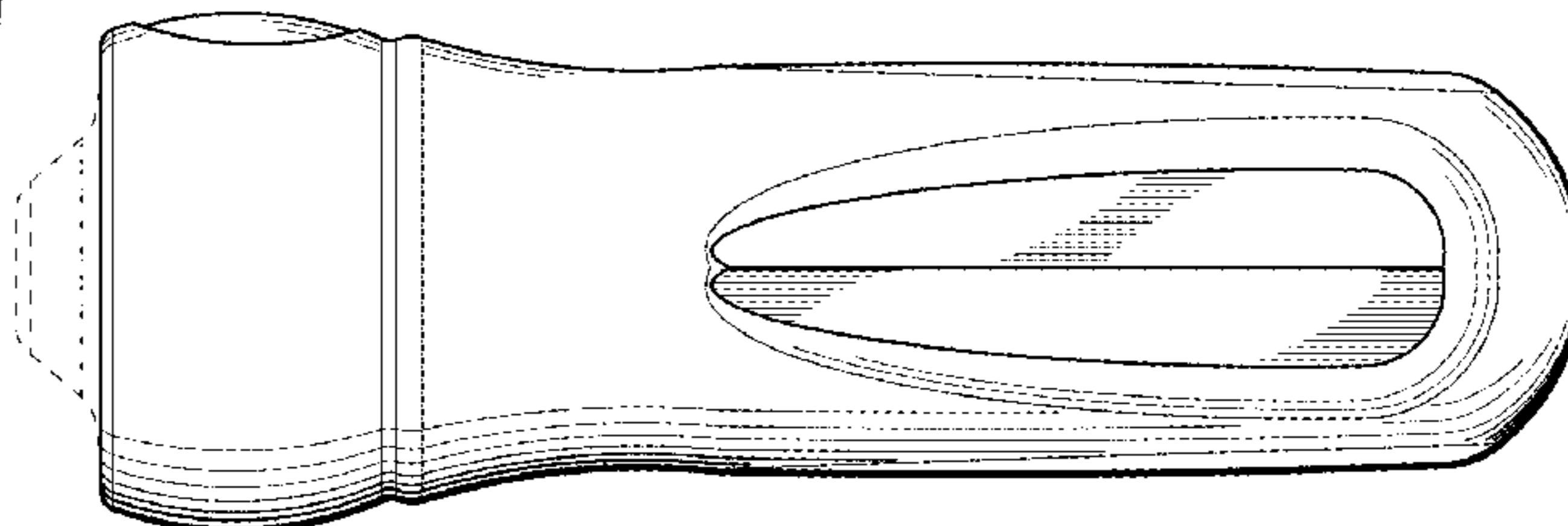
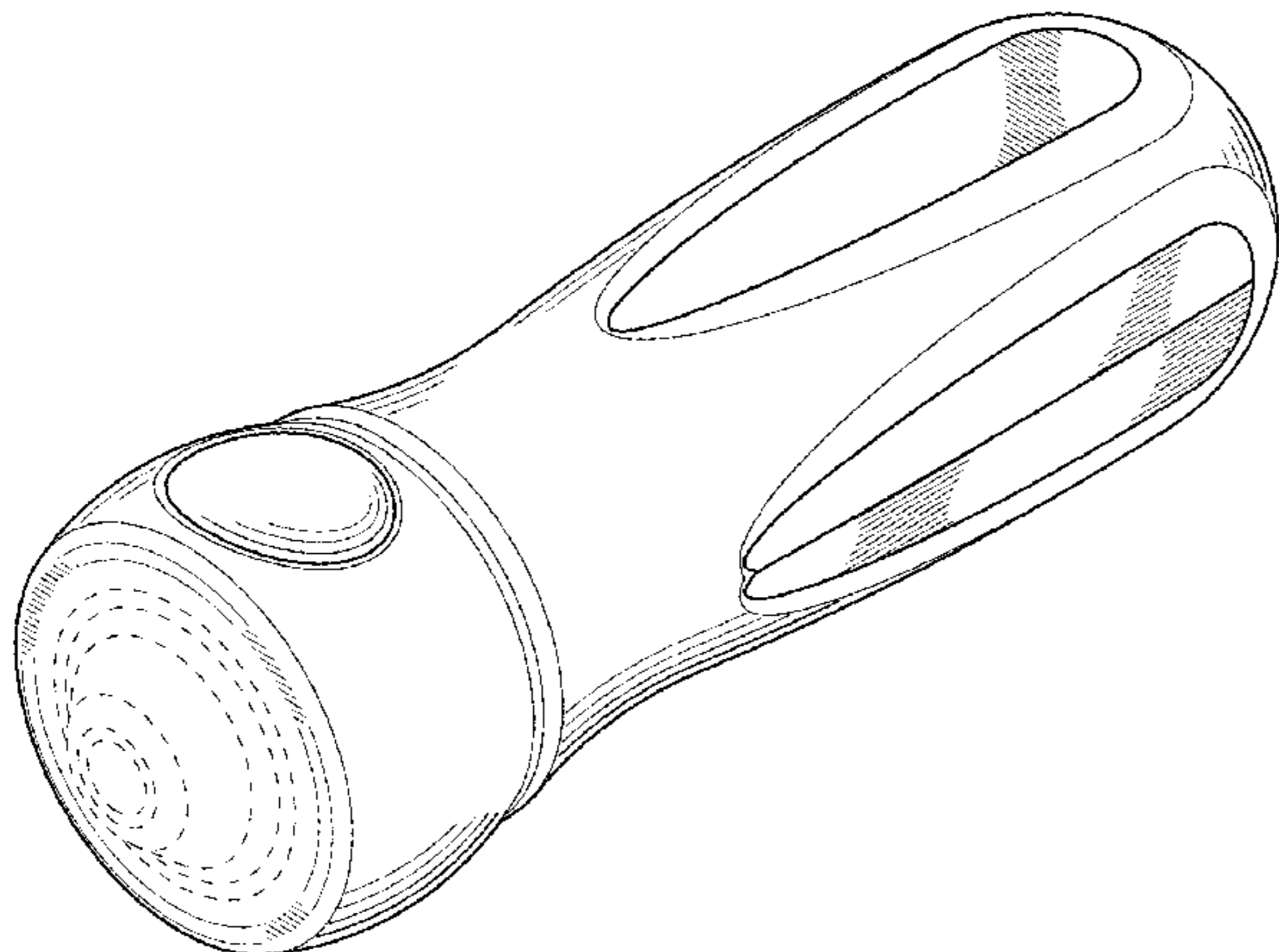



(56)

## References Cited

## U.S. PATENT DOCUMENTS

D398,507	S	*	9/1998	Thompson	.....	D8/107
D398,508	S	*	9/1998	Thompson	.....	D8/107
D398,828	S	*	9/1998	Shiao	.....	D8/107
D399,722	S	*	10/1998	Eidsmoe	.....	D8/107
D401,491	S	*	11/1998	Shiao	.....	D8/83
D408,258	S	*	4/1999	Tsai	.....	D8/107
D412,760	S	*	8/1999	McCalla	.....	D26/38
D414,095	S	*	9/1999	Hoepfl	.....	D8/107
D414,096	S	*	9/1999	Chapin	.....	D8/107
D415,005	S	*	10/1999	Chen	.....	D8/107
D416,464	S	*	11/1999	Eason	.....	D8/300
D416,776	S	*	11/1999	Liu	.....	D8/107
D418,035	S	*	12/1999	Hatch	.....	D8/107
D419,846	S	*	2/2000	Hasan	.....	D8/83
D420,559	S	*	2/2000	Chang	.....	D8/107
D421,886	S	*	3/2000	Jau	.....	D8/107
D422,474	S	*	4/2000	Shiao	.....	D8/107
D422,727	S	*	4/2000	McCalla	.....	D26/38
D424,904	S	*	5/2000	Hasan	.....	D8/83
D434,149	S	*	11/2000	Mirhashemi	.....	D24/133
D435,773	S	*	1/2001	Lin	.....	D8/107
D440,480	S	*	4/2001	Tseng	.....	D8/82
D442,049	S	*	5/2001	Shu	.....	D8/107
D442,050	S	*	5/2001	Hung	.....	D8/107
D442,843	S	*	5/2001	Hsu	.....	D8/107
D444,047	S	*	6/2001	Chen	.....	D8/107
D444,366	S	*	7/2001	Rinner	.....	D8/107
D444,370	S	*	7/2001	Chang	.....	D8/107
D445,658	S	*	7/2001	Dierolf	.....	D8/107
D446,706	S	*	8/2001	Kalomeris	.....	D8/107
D448,641	S	*	10/2001	Sato	.....	D8/82
D449,505	S	*	10/2001	Glass	.....	D8/83
D452,423	S	*	12/2001	Shimansky	.....	D8/107
D452,426	S	*	12/2001	Milan	.....	D8/107
D452,427	S	*	12/2001	Milan	.....	D8/107
D454,046	S	*	3/2002	Hsieh	.....	D8/107
D454,770	S	*	3/2002	Chang	.....	D8/107
D456,686	S	*	5/2002	Holland-Letz	.....	D8/83
D459,186	S	*	6/2002	Chang	.....	D8/83
D462,440	S	*	9/2002	Formanek	.....	D24/133
D463,242	S	*	9/2002	Chen	.....	D8/107
D463,243	S	*	9/2002	Lisle	.....	D8/107
D468,182	S	*	1/2003	Thompson	.....	D8/107
D473,442	S	*	4/2003	Metcalf	.....	D8/107
D473,443	S	*	4/2003	Metcalf	.....	D8/107
D475,268	S	*	6/2003	Lisle	.....	D8/107
D481,612	S	*	11/2003	Tsai	.....	D8/107
D482,588	S	*	11/2003	Lai	.....	D8/107
D482,589	S	*	11/2003	Rampen	.....	D8/107
D482,590	S	*	11/2003	Lisle	.....	D8/107
D486,717	S	*	2/2004	Chen	.....	D8/107
D487,690	S	*	3/2004	Hu	.....	D8/83
D493,527	S	*	7/2004	Szabo	.....	D24/133
D494,038	S	*	8/2004	Shih	.....	D8/107
D494,443	S	*	8/2004	Saunders	.....	D8/107
D507,733	S	*	7/2005	Liu	.....	D8/83
D508,644	S	*	8/2005	Ho	.....	D8/83
D510,248	S	*	10/2005	Liu	.....	D8/83
D510,692	S	*	10/2005	Walker	.....	D8/83
D513,378	S	*	1/2006	Lin	.....	D8/83
D515,388	S	*	2/2006	Howard	.....	D8/82
D515,389	S	*	2/2006	Hsu	.....	D8/83
D517,388	S	*	3/2006	Hsieh	.....	D8/107
D517,889	S	*	3/2006	Hsieh	.....	D8/107
D519,352	S	*	4/2006	Chou	.....	D32/48
D519,819	S	*	5/2006	Jimenez	.....	D8/10
D520,138	S	*	5/2006	Kuhn	.....	D24/152
D520,325	S	*	5/2006	Su	.....	D8/83
D523,234	S	*	6/2006	DeBoer	.....	D8/87
D523,315	S	*	6/2006	Kienzler	.....	D8/107
D523,724	S	*	6/2006	Rinner	.....	D8/107
D525,850	S	*	8/2006	Huang	.....	D8/83
D526,184	S	*	8/2006	Yu	.....	D8/107
D526,554	S	*	8/2006	Chen	.....	D8/107
D526,875	S	*	8/2006	Chen	.....	D8/107
D528,891	S	*	9/2006	Thompson	.....	D4/119
D530,567	S	*	10/2006	Timm	.....	D7/395
D531,004	S	*	10/2006	Wang	.....	D8/107
D531,005	S	*	10/2006	Chang	.....	D8/107
D531,006	S	*	10/2006	Tsai	.....	D8/107
D531,310	S	*	10/2006	Wolter	.....	D24/133
D531,472	S	*	11/2006	Schiller	.....	D8/61
D531,480	S	*	11/2006	Tsai	.....	D8/107
D532,276	S	*	11/2006	Lin	.....	D8/107
D532,277	S	*	11/2006	Shih	.....	D8/107
D532,278	S	*	11/2006	Shih	.....	D8/107
D533,276	S	*	12/2006	Nakanishi	.....	D24/152
D533,428	S	*	12/2006	Tsai	.....	D8/107
D535,170	S	*	1/2007	Caplan	.....	D8/82
D539,621	S	*	4/2007	Jimenez	.....	D8/10
D542,620	S	*	5/2007	Thompson	.....	D8/107
D544,674	S	*	6/2007	Hsieh	.....	D34/35
D552,956	S	*	10/2007	Wen	.....	D8/107
D553,464	S	*	10/2007	Rinner	.....	D8/83
D554,967	S	*	11/2007	Lin	.....	D8/107
7,293,482	B1	*	11/2007	Wolf	.....	B25B 13/5091 81/124.2
D563,752	S	*	3/2008	Fach	.....	D8/107
D565,379	S	*	4/2008	Williams	.....	D8/83
D567,621	S	*	4/2008	Singh	.....	D8/83
D569,210	S	*	5/2008	Chien	.....	D8/83
D569,517	S	*	5/2008	Wilkinson	.....	D24/146
D569,975	S	*	5/2008	Wilkinson	.....	D24/146
D570,644	S	*	6/2008	Smith	.....	D7/395
D572,105	S	*	7/2008	Brockman	.....	D8/83
D574,208	S	*	8/2008	Lin	.....	D8/107
D575,132	S	*	8/2008	Panier	.....	D8/107
D576,467	S	*	9/2008	Shu	.....	D8/107
D580,054	S	*	11/2008	Thomssen	.....	D24/152
D585,987	S	*	2/2009	Aparici	.....	D24/133
D587,803	S	*	3/2009	Di Sessa	.....	D24/133
D596,473	S	*	7/2009	McKenzie	.....	D8/85
D603,683	S	*	11/2009	Hu	.....	D8/107
D607,300	S	*	1/2010	Lin	.....	D8/107
D607,708	S	*	1/2010	Himbert	.....	D8/107
D610,891	S	*	3/2010	Whitfield	.....	D8/83
D617,169	S	*	6/2010	Robinson	.....	D8/107
D617,170	S	*	6/2010	Lai	.....	D8/107
D622,124	S	*	8/2010	Kegg	.....	D8/83
D622,766	S	*	8/2010	DaBoll	.....	D19/179
D624,321	S	*	9/2010	Rennette	.....	D4/121
D627,461	S	*	11/2010	Cantu	.....	D24/140
D629,666	S	*	12/2010	Lai	.....	D8/83
D633,357	S	*	3/2011	Garcia	.....	D8/83
D633,358	S	*	3/2011	Deguglimo	.....	D8/83
D634,172	S	*	3/2011	Robinson	.....	D8/83
RE42,278	E	*	4/2011	Kienzler	.....	D8/82
D635,430	S	*	4/2011	Robinson	.....	D8/83
D636,654	S	*	4/2011	Robinson	.....	D8/83
D636,655	S	*	4/2011	Quinlan	.....	D8/330
D640,114	S	*	6/2011	Molina	.....	D8/83
D642,887	S	*	8/2011	Good	.....	D8/83
D644,902	S	*	9/2011	Yang	.....	D8/83
D644,910	S	*	9/2011	Hsu	.....	D8/107
D645,717	S	*	9/2011	Ou	.....	D8/83
D646,545	S	*	10/2011	Molina	.....	D8/83
D647,613	S	*	10/2011	Paget	.....	D24/133
8,032,991	B2	*	10/2011	Lawless	.....	B25G 1/105 16/430
D648,851	S	*	11/2011	Copeland	.....	D24/133
8,051,538	B2	*	11/2011	Hsieh	.....	B25G 1/105 16/436
D652,137	S	*	1/2012	Nino	.....	D24/133
D652,138	S	*	1/2012	Nino	.....	D24/133
D653,515	S	*	2/2012	De Salvo	.....	D8/83
D655,002	S	*	2/2012	Bast	.....	D24/133
D655,412	S	*	3/2012	Luk	.....	D24/130
D655,413	S	*	3/2012	Nino	.....	D24/133
D655,815	S	*	3/2012	Miller	.....	D24/133
D657,224	S	*	4/2012	Molina	.....	D8/83
D660,421	S	*	5/2012	Miller	.....	D24/133
D660,965	S	*	5/2012	Waclawik	.....	D24/152
D668,338	S	*	10/2012	Bast	.....	D24/145
D671,813	S	*	12/2012	Lin	.....	D8/83



(56)

References Cited

U.S. PATENT DOCUMENTS

D675,318 S \* 1/2013 Luk ..... D24/130  
 D677,381 S \* 3/2013 Stones ..... D24/113  
 D684,836 S \* 6/2013 Wong ..... D8/82  
 D685,621 S \* 7/2013 Lin ..... D8/83  
 D686,479 S \* 7/2013 Robinson ..... D8/83  
 D686,480 S \* 7/2013 Robinson ..... D8/83  
 D686,899 S \* 7/2013 Lin ..... D8/83  
 D691,014 S \* 10/2013 Hyma ..... D8/83  
 D691,015 S \* 10/2013 Hyma ..... D8/83  
 D691,016 S \* 10/2013 Hyma ..... D8/83  
 D692,134 S \* 10/2013 Lee-Sepsick ..... D24/146  
 D695,089 S \* 12/2013 Nelson ..... D8/83  
 D695,398 S \* 12/2013 Solomon ..... D24/129  
 D707,527 S \* 6/2014 Hsieh ..... B25G 1/005  
 D714,117 S \* 9/2014 Smidt ..... D8/29  
 D714,604 S \* 10/2014 Robinson ..... D8/25  
 D715,125 S \* 10/2014 Hung ..... D8/107  
 D717,142 S \* 11/2014 Jannitto, Jr. .... D8/21  
 D717,143 S \* 11/2014 Jannitto ..... D8/21  
 D720,590 S \* 1/2015 Carl ..... D8/85  
 D720,591 S \* 1/2015 Carl ..... D8/85  
 D720,594 S \* 1/2015 Henderson ..... D8/107  
 D725,454 S \* 3/2015 Lin ..... D8/107  
 D727,129 S \* 4/2015 Robinson ..... D8/83  
 D727,130 S \* 4/2015 Robinson ..... D8/83  
 D727,131 S \* 4/2015 Henderson ..... D8/107  
 9,108,304 B2 \* 8/2015 Lai ..... B25B 13/468  
 D739,018 S \* 9/2015 Murias ..... D24/147  
 D741,992 S \* 10/2015 Roeper ..... A61F 2/966  
 D742,005 S \* 10/2015 Komuda ..... D24/146  
 D743,221 S \* 11/2015 Wisman ..... D8/14  
 D743,233 S \* 11/2015 Cluthe ..... D8/85  
 D750,236 S \* 2/2016 Maurice ..... D24/129  
 D769,689 S \* 10/2016 Squiers ..... D8/83  
 9,457,457 B2 \* 10/2016 Chiang ..... B25B 13/465  
 D771,247 S \* 11/2016 Shinohara ..... D24/130  
 9,511,484 B2 \* 12/2016 Marchant ..... B25B 15/04  
 D776,815 S \* 1/2017 Carron ..... D24/152  
 D777,317 S \* 1/2017 Soual ..... B25B 15/02  
 D782,037 S \* 3/2017 Osypka ..... D24/130  
 D782,268 S \* 3/2017 Bast ..... D8/107  
 D782,269 S \* 3/2017 Bast ..... D8/107  
 D782,667 S \* 3/2017 Fuhr ..... D24/137  
 D782,668 S \* 3/2017 Fuhr ..... D24/137  
 D782,669 S \* 3/2017 Fuhr ..... D24/137

D783,819 S \* 4/2017 Thome ..... D24/152  
 D791,310 S \* 7/2017 Maurice ..... D24/129  
 D791,941 S \* 7/2017 Burachynsky ..... D24/133  
 D791,978 S \* 7/2017 Markus ..... D25/133  
 9,698,580 B2 \* 7/2017 Chen ..... B25B 15/02  
 D793,837 S \* 8/2017 Su ..... D8/107  
 D797,539 S \* 9/2017 Lipscomb ..... D8/99  
 D800,528 S \* 10/2017 Leibowitz ..... D8/83  
 D800,529 S \* 10/2017 Leibowitz ..... B25B 13/5091  
 D808,83  
 9,796,070 B2 \* 10/2017 Sun ..... B25G 1/063  
 D802,777 S \* 11/2017 Burachynsky ..... D24/187  
 D807,138 S \* 1/2018 Rinner ..... D8/83  
 D809,365 S \* 2/2018 Su ..... D8/107  
 D810,538 S \* 2/2018 Ou ..... D8/83  
 D819,417 S \* 6/2018 Graykowski ..... D8/47  
 D820,441 S \* 6/2018 Ketelhohn ..... A61M 1/0058  
 D824,127  
 D829,524 S \* 10/2018 Su ..... D8/83  
 D830,151 S \* 10/2018 Weinberg ..... D8/107  
 D839,073 S \* 1/2019 Bast ..... D8/107  
 10,183,383 B2 \* 1/2019 Lai ..... B25B 23/0007  
 D840,031 S \* 2/2019 Teufel ..... D24/140  
 D840,207 S \* 2/2019 Sun ..... D8/107  
 D845,102 S \* 4/2019 Hofer ..... D8/85  
 D854,153 S \* 7/2019 Hsieh ..... D24/146  
 D855,433 S \* 8/2019 Hyma ..... D8/83  
 D859,139 S \* 9/2019 Hill ..... D8/394  
 D859,652 S \* 9/2019 Teufel ..... D24/133  
 D860,750 S \* 9/2019 Beh ..... D8/83  
 D865,477 S \* 11/2019 Lipscomb ..... D8/82  
 D865,965 S \* 11/2019 Siciliano ..... D24/146  
 D866,283 S \* 11/2019 Hahn ..... D8/83  
 D867,092 S \* 11/2019 Hahn ..... D8/83  
 D867,845 S \* 11/2019 Hsu ..... D8/83  
 D886,555 S \* 6/2020 Scott ..... D8/14  
 D890,592 S \* 7/2020 Barajas ..... D8/107  
 D891,899 S \* 8/2020 Barajas ..... D8/107  
 D892,215 S \* 8/2020 Laemle ..... D19/182  
 D897,181 S \* 9/2020 Johnson ..... D8/83  
 D900,584 S \* 11/2020 Bast ..... B25B 15/04  
 D8/107  
 D900,585 S \* 11/2020 Bast ..... B25G 1/085  
 D8/107  
 D901,685 S \* 11/2020 Wang ..... D24/144  
 D904,698 S \* 12/2020 Moeller ..... D30/158  
 D904,851 S \* 12/2020 Levand ..... D8/107  
 D904,852 S \* 12/2020 Levand ..... D8/107  
 D906,782 S \* 1/2021 Brinson ..... D8/83

\* cited by examiner

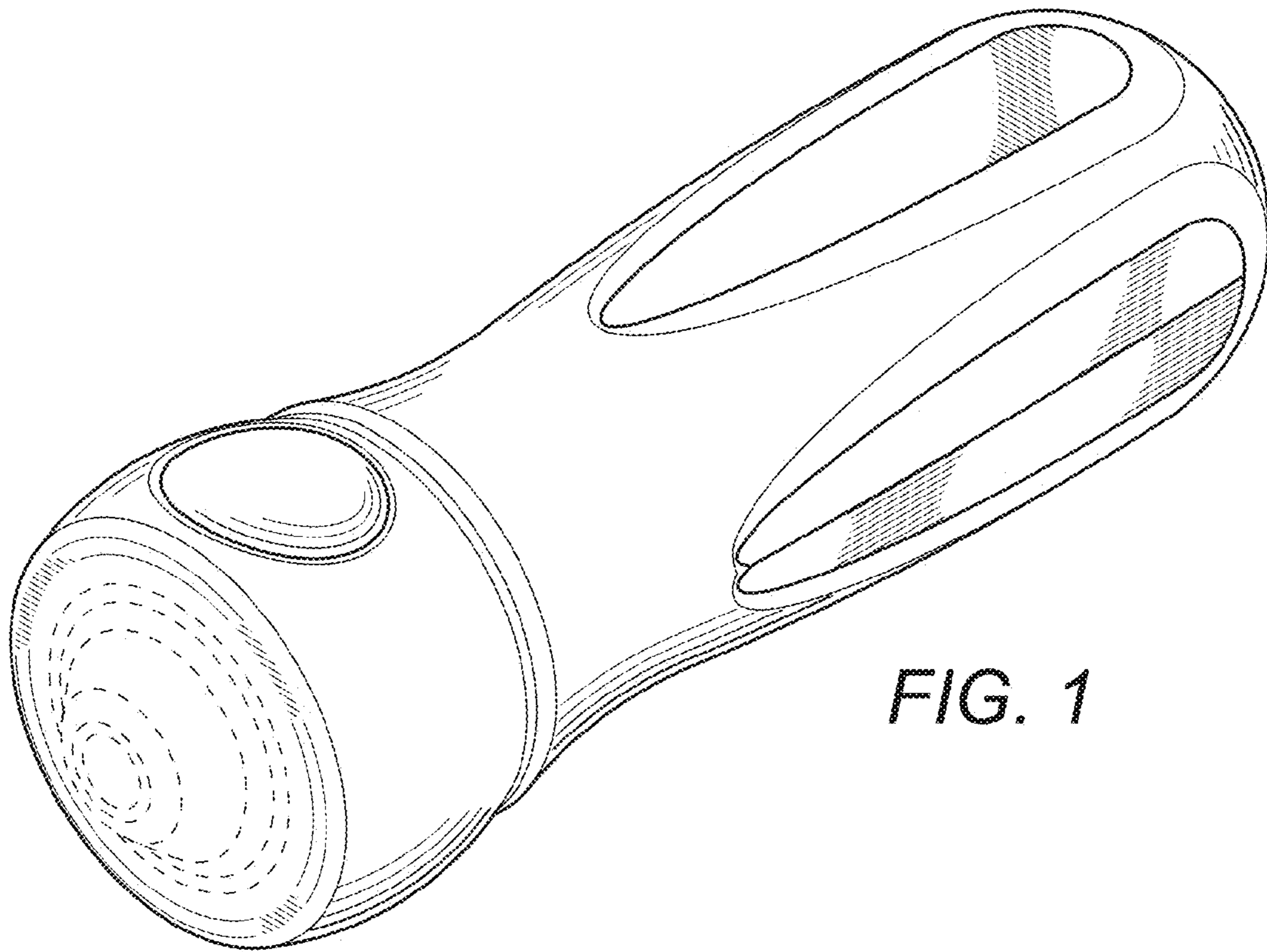

FIG. 1

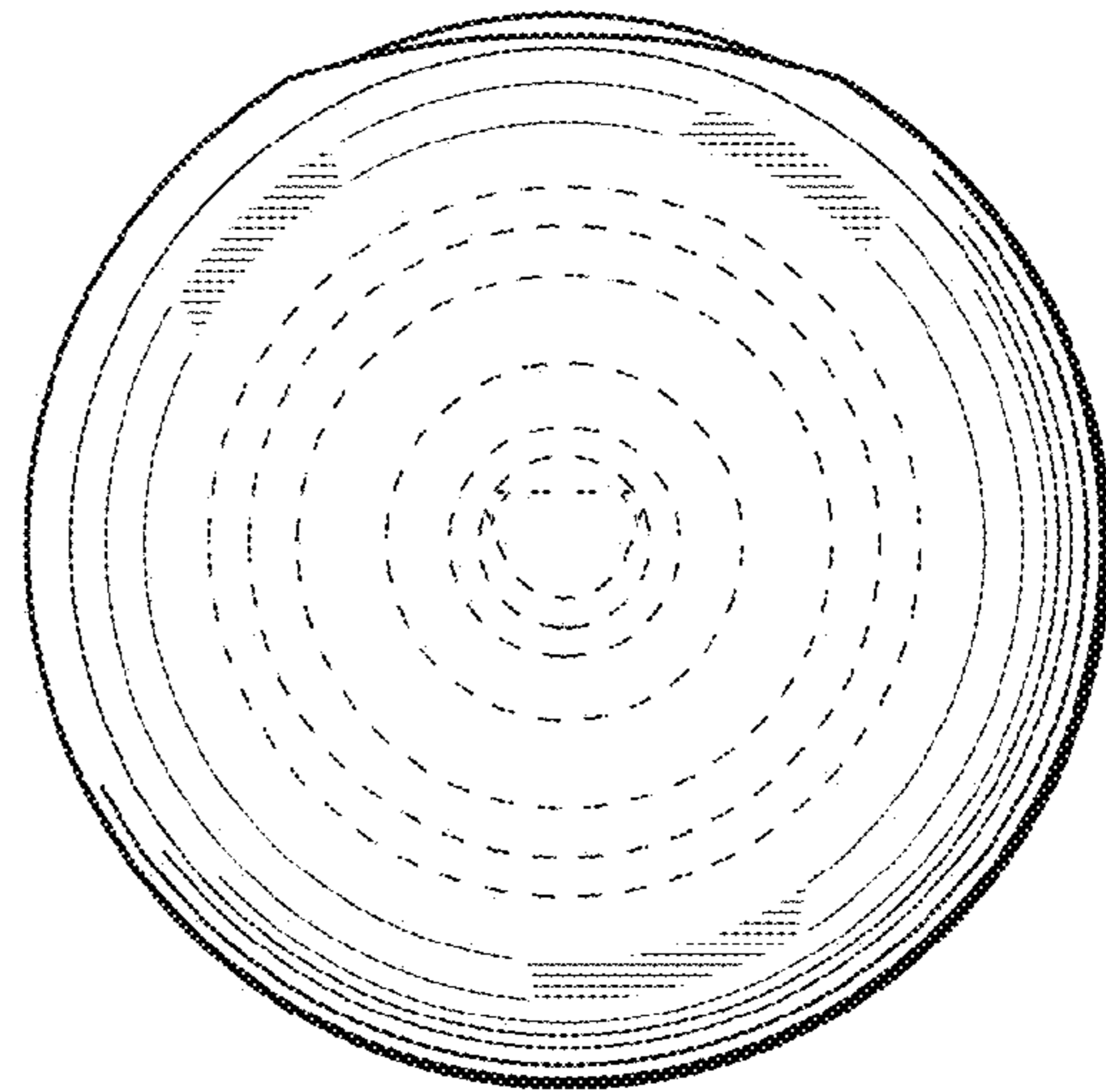

FIG. 2

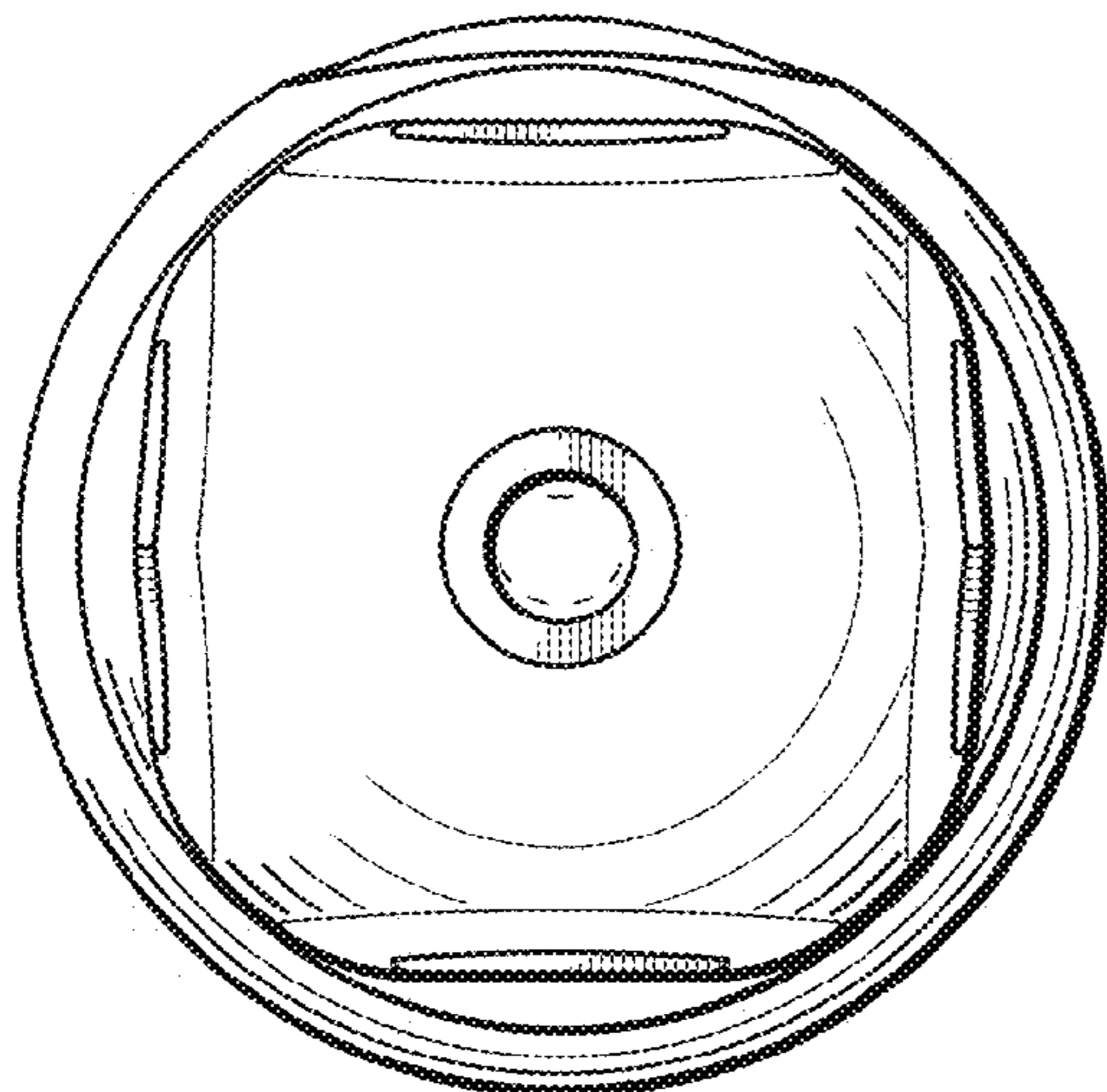

FIG. 3



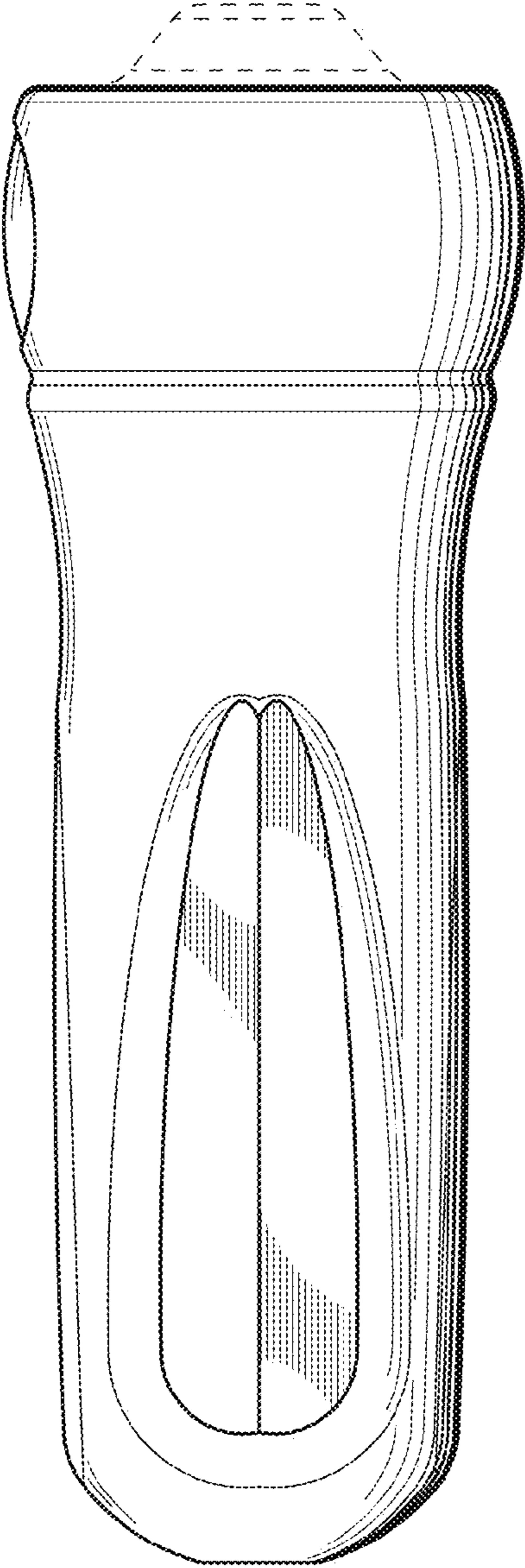

FIG. 4

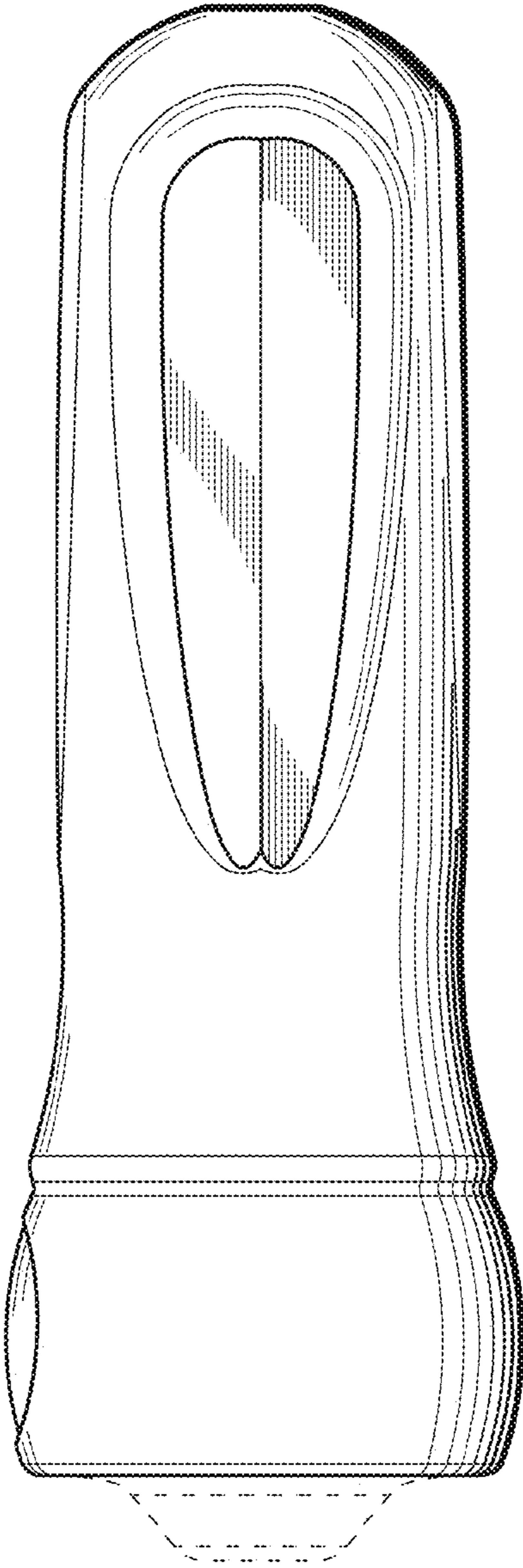
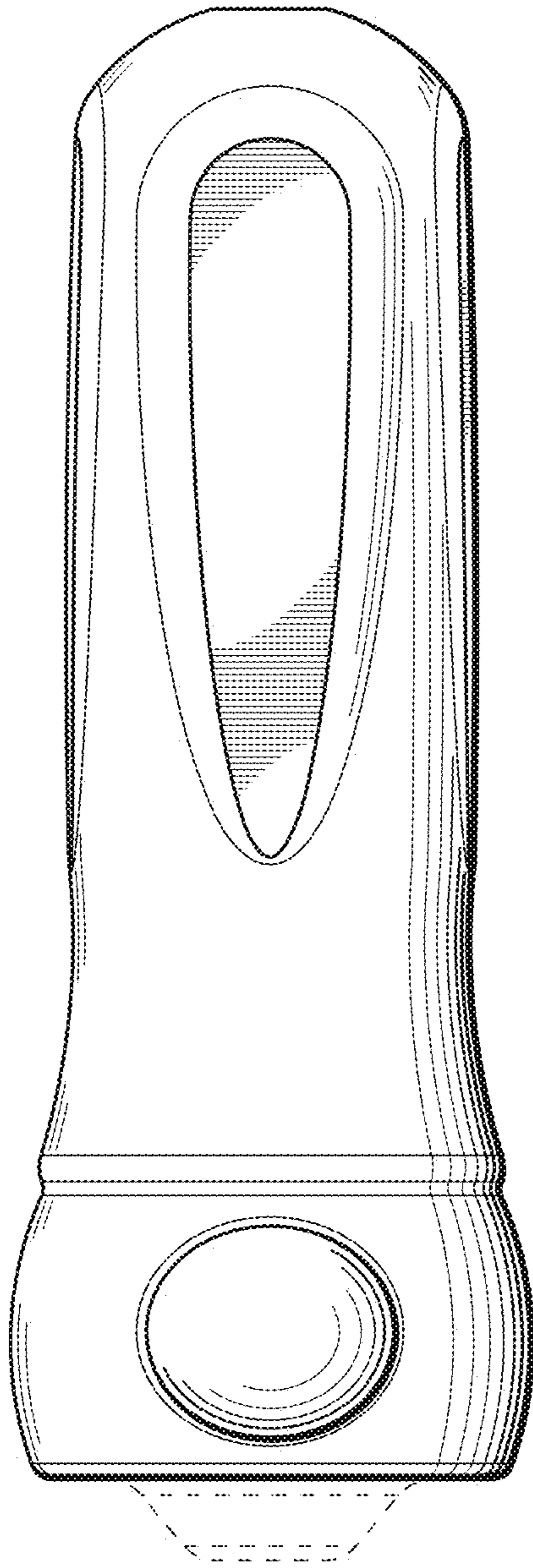
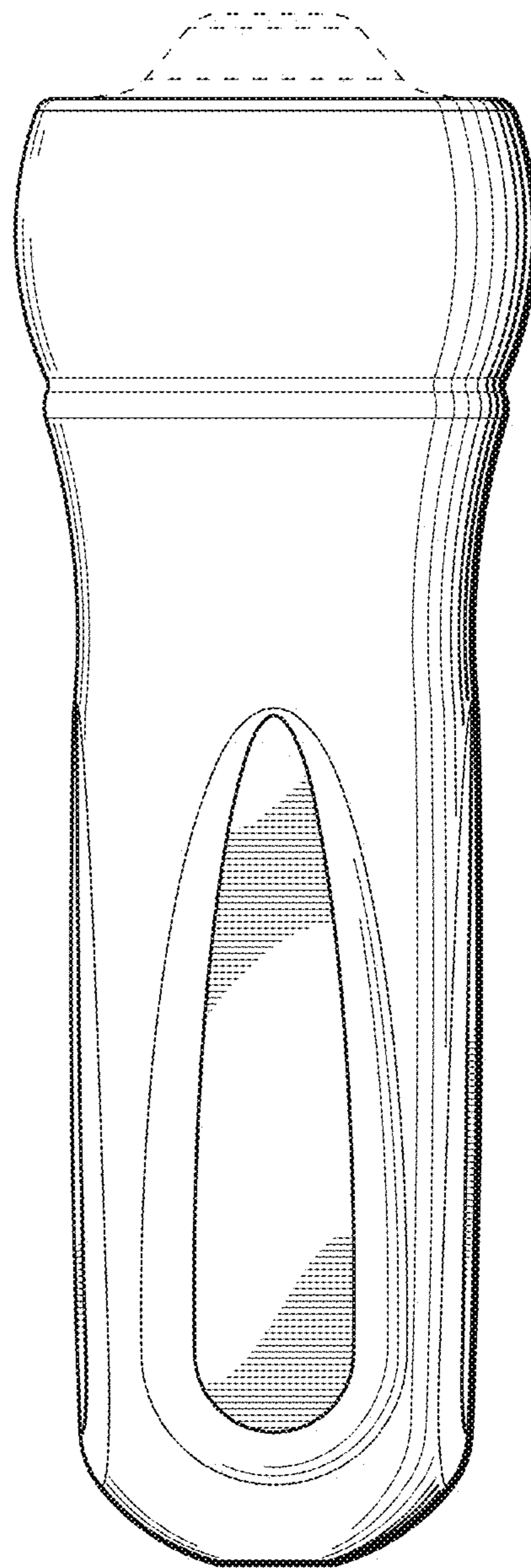

FIG. 5



*FIG. 6*



*FIG. 7*