



US00D921811S

(12) **United States Design Patent**  
**Cheng**

(10) **Patent No.:** **US D921,811 S**  
(45) **Date of Patent:** **\*\* Jun. 8, 2021**

- (54) **TENT**
- (71) Applicant: **HUANGSHAN CITY**  
**HUILINGYANG OUTDOOR**  
**PRODUCTS CO., LTD.**, Huangshan  
(CN)
- (72) Inventor: **Zhengrui Cheng**, Huangshan (CN)
- (73) Assignee: **HUANGSHAN CITY**  
**HUILINGYANG OUTDOOR**  
**PRODUCTS CO., LTD.**, Huangshan  
(CN)
- (\*\*) Term: **15 Years**
- (21) Appl. No.: **29/713,046**
- (22) Filed: **Nov. 13, 2019**
- (51) **LOC (13) Cl.** ..... **21-04**
- (52) **U.S. Cl.**  
USPC ..... **D21/834**
- (58) **Field of Classification Search**  
USPC ..... D21/834-838; D12/56  
CPC ..... E04H 15/00; E04H 15/003; E04H 15/18;  
E04H 15/28; E04H 15/32; E04H 15/34;  
E04H 15/40; E04H 15/405; E04H 15/42;  
E04H 15/425; E04H 15/44; E04H 15/52  
See application file for complete search history.

- D725,211 S \* 3/2015 Lah ..... D21/834
- D778,382 S \* 2/2017 Weber ..... D21/834
- D858,676 S \* 9/2019 Xu ..... D21/834
- D864,333 S \* 10/2019 Wu ..... D21/834
- D879,231 S \* 3/2020 Zhu ..... D21/834
- 2011/0073147 A1\* 3/2011 Choi ..... E04H 15/42  
135/135
- 2013/0061896 A1\* 3/2013 Webster ..... E04H 15/14  
135/93

\* cited by examiner

*Primary Examiner* — Cynthia M. Chin

(74) *Attorney, Agent, or Firm* — Law Offices of Steven  
W. Weinrieb

(57) **CLAIM**

The ornamental design for a tent, as shown and described.

**DESCRIPTION**

FIG. 1 is a front, right side, top perspective view of a tent showing my new design;  
 FIG. 2 is a rear, left side, top perspective view thereof;  
 FIG. 3 is a front elevational view thereof;  
 FIG. 4 is a rear elevational view thereof;  
 FIG. 5 is a left side elevational view thereof;  
 FIG. 6 is a right side elevational view thereof;  
 FIG. 7 is a top plan view thereof;  
 FIG. 8 is a bottom plan view thereof;  
 FIG. 9 is an enlarged partial view of the tent hub connector taken from the top of FIG. 2; and,  
 FIG. 10 is a front, right side, top perspective view thereof when the front flap of the tent is opened.  
 The broken lines represent the boundaries of the enlarged partial views of FIG. 9 and forms no part of the claimed design.

**1 Claim, 10 Drawing Sheets**

(56) **References Cited**

**U.S. PATENT DOCUMENTS**

- 4,750,509 A \* 6/1988 Kim ..... E04H 15/36  
135/135
- 5,195,551 A \* 3/1993 Ju ..... E04H 15/425  
135/126
- 5,666,986 A \* 9/1997 Fox ..... E04H 15/42  
135/135
- D535,350 S \* 1/2007 Ju ..... D21/834

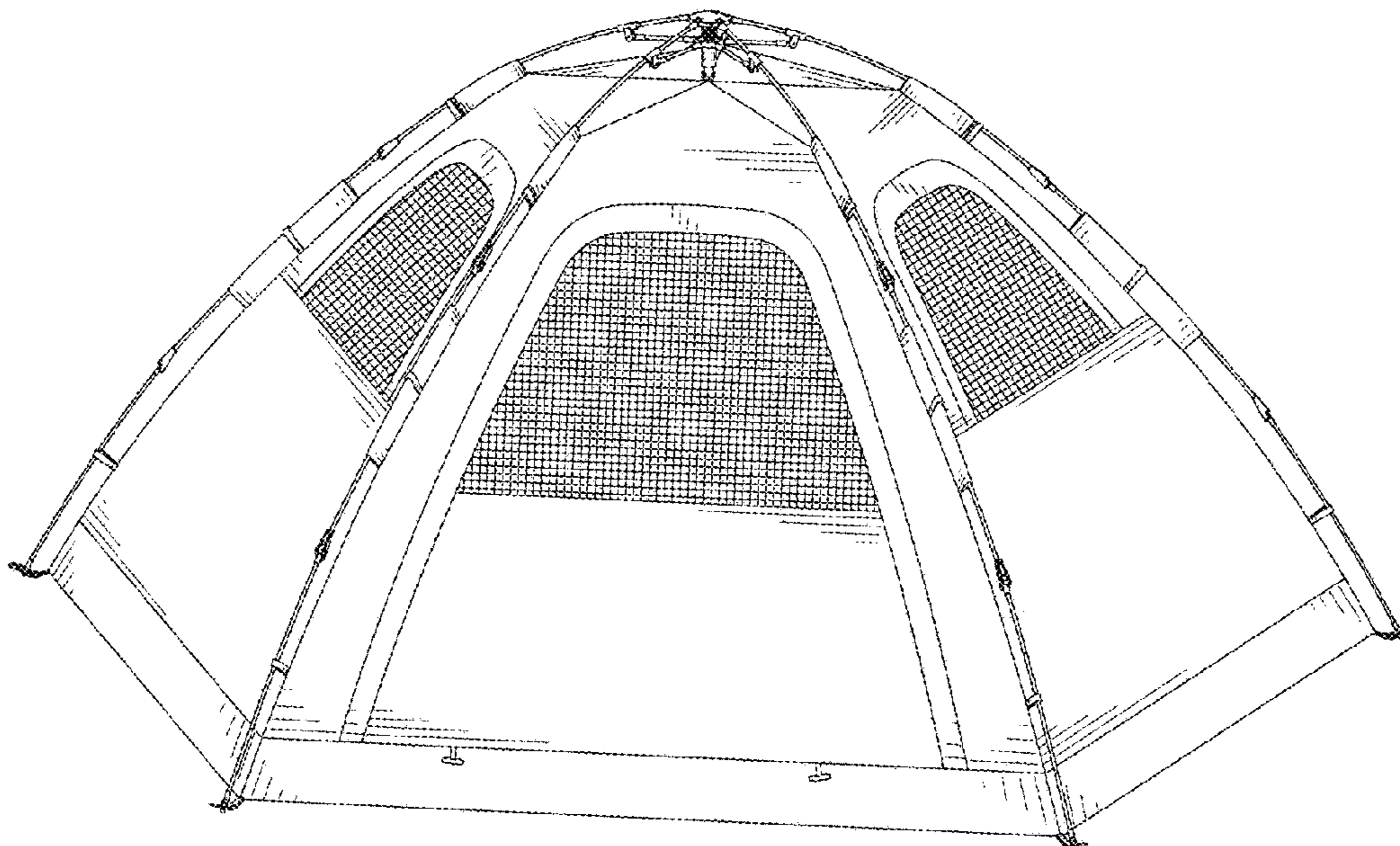

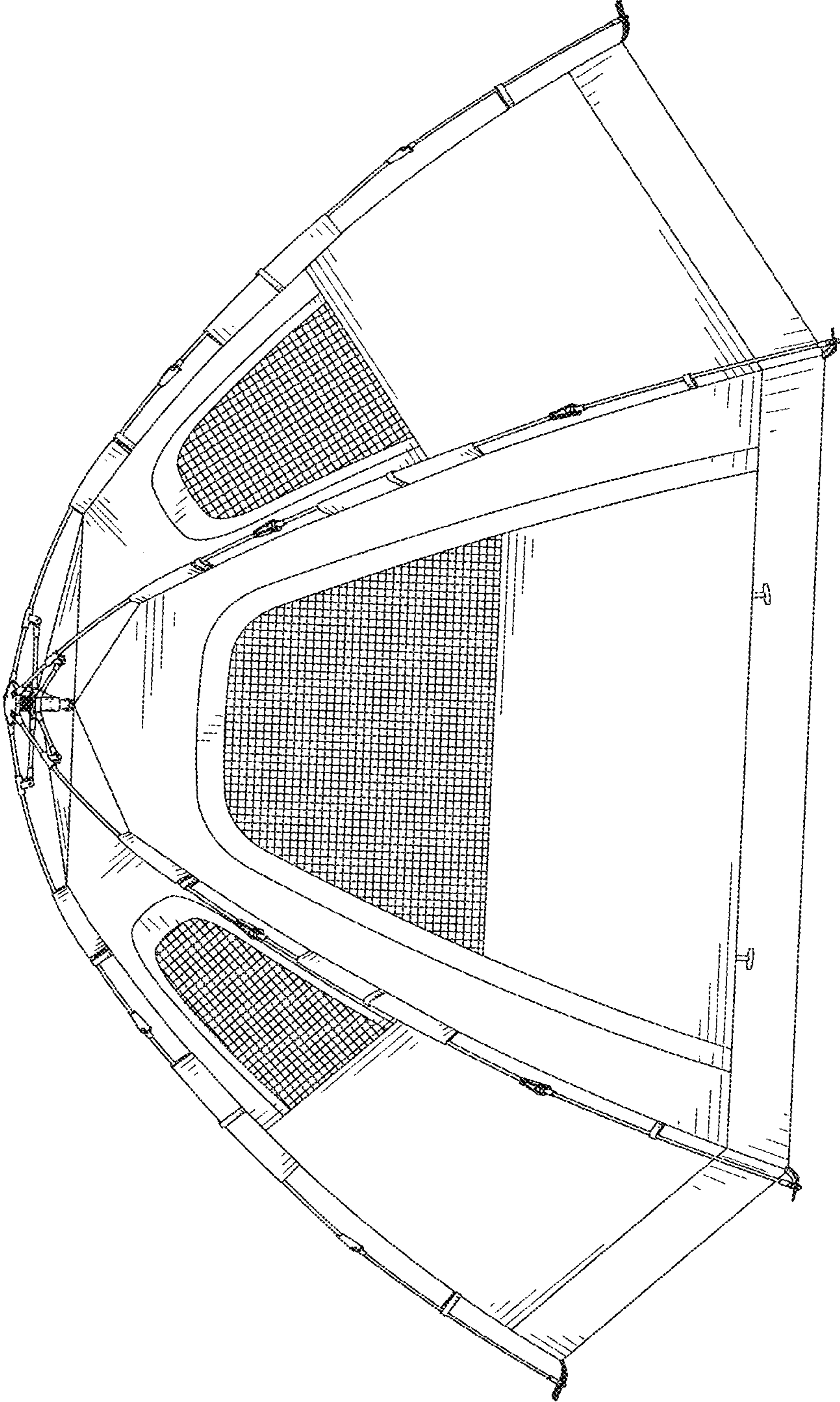

FIG. 1



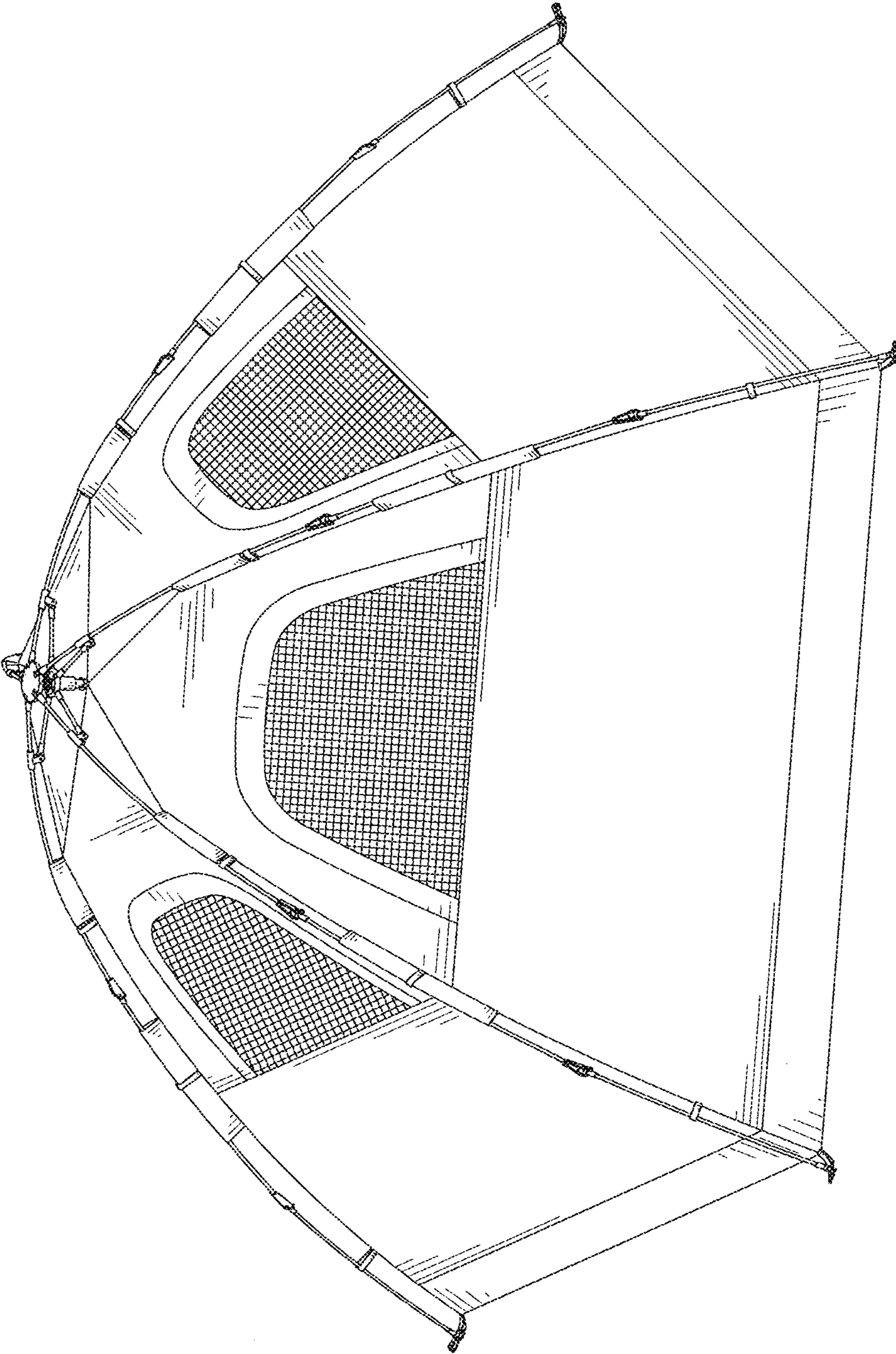

FIG. 2

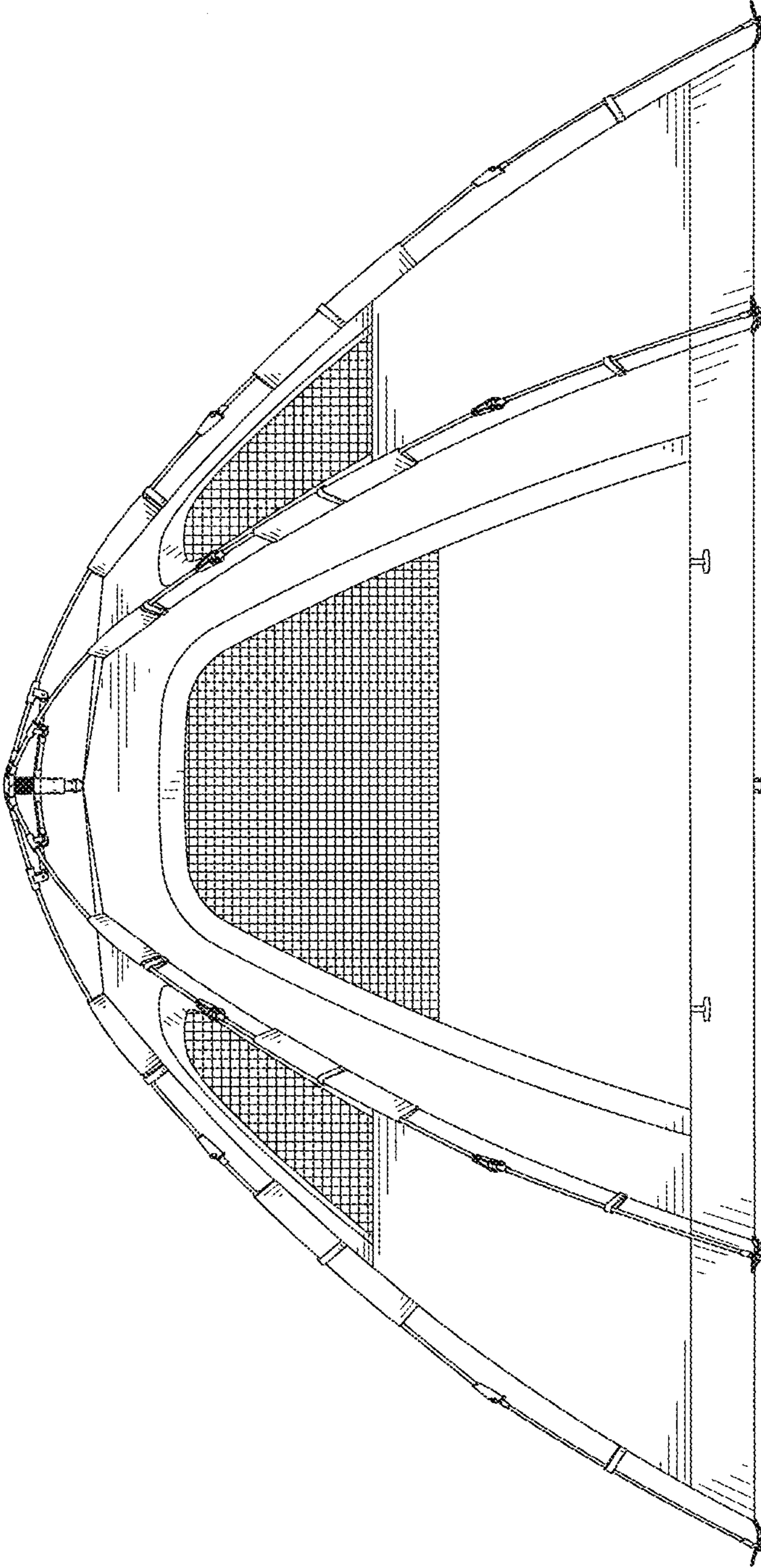

FIG. 3

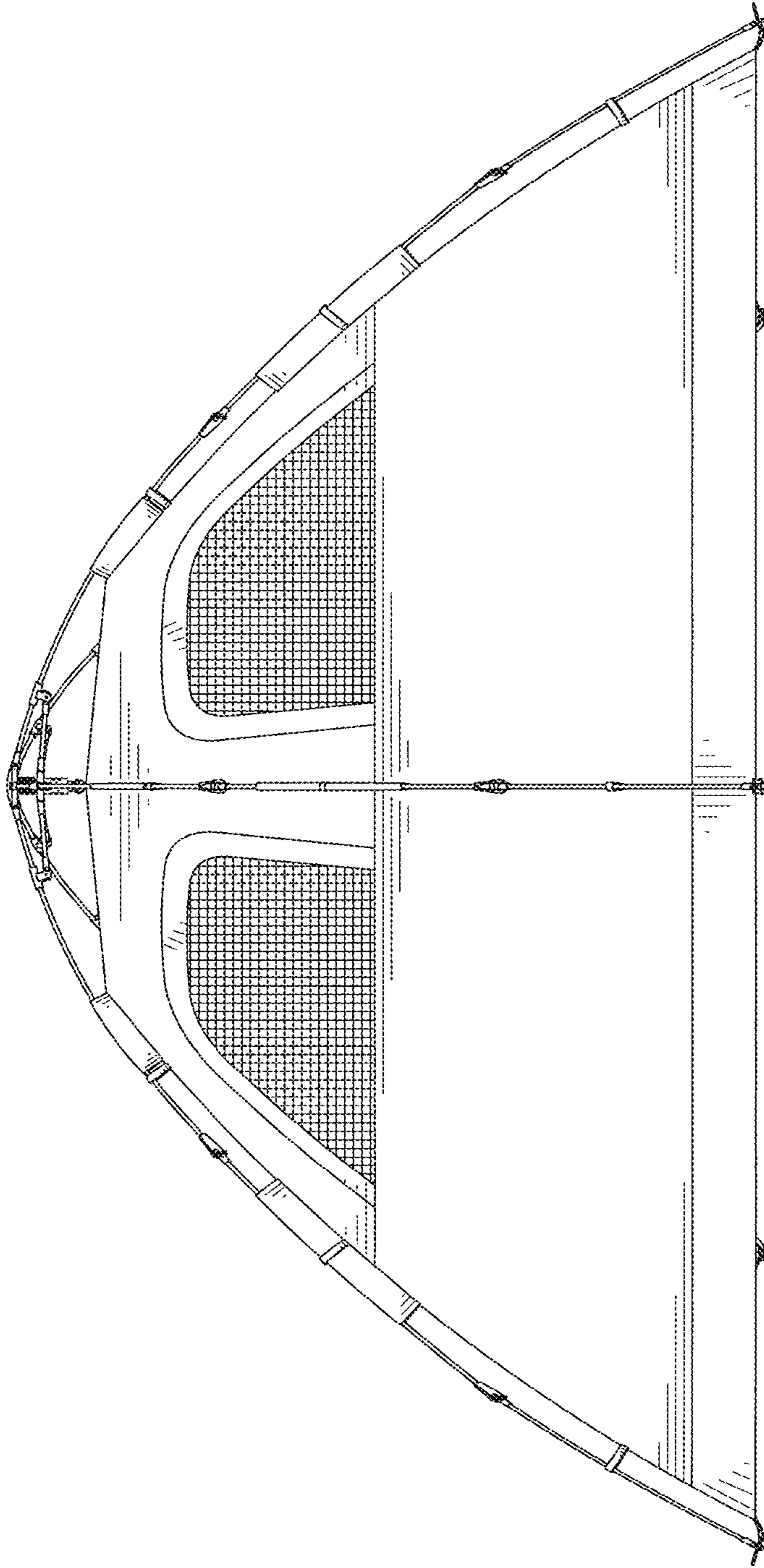

FIG. 4



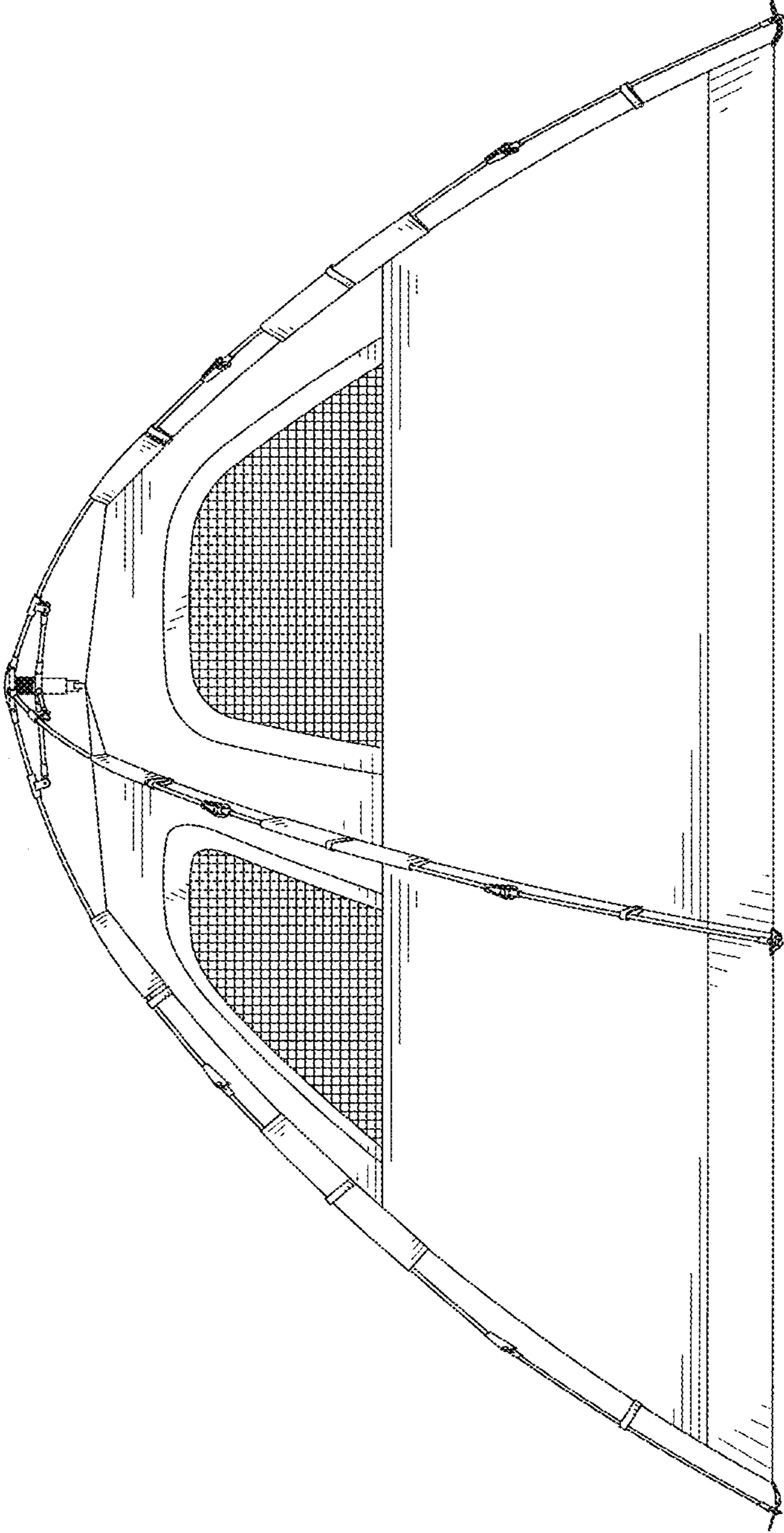

FIG. 5

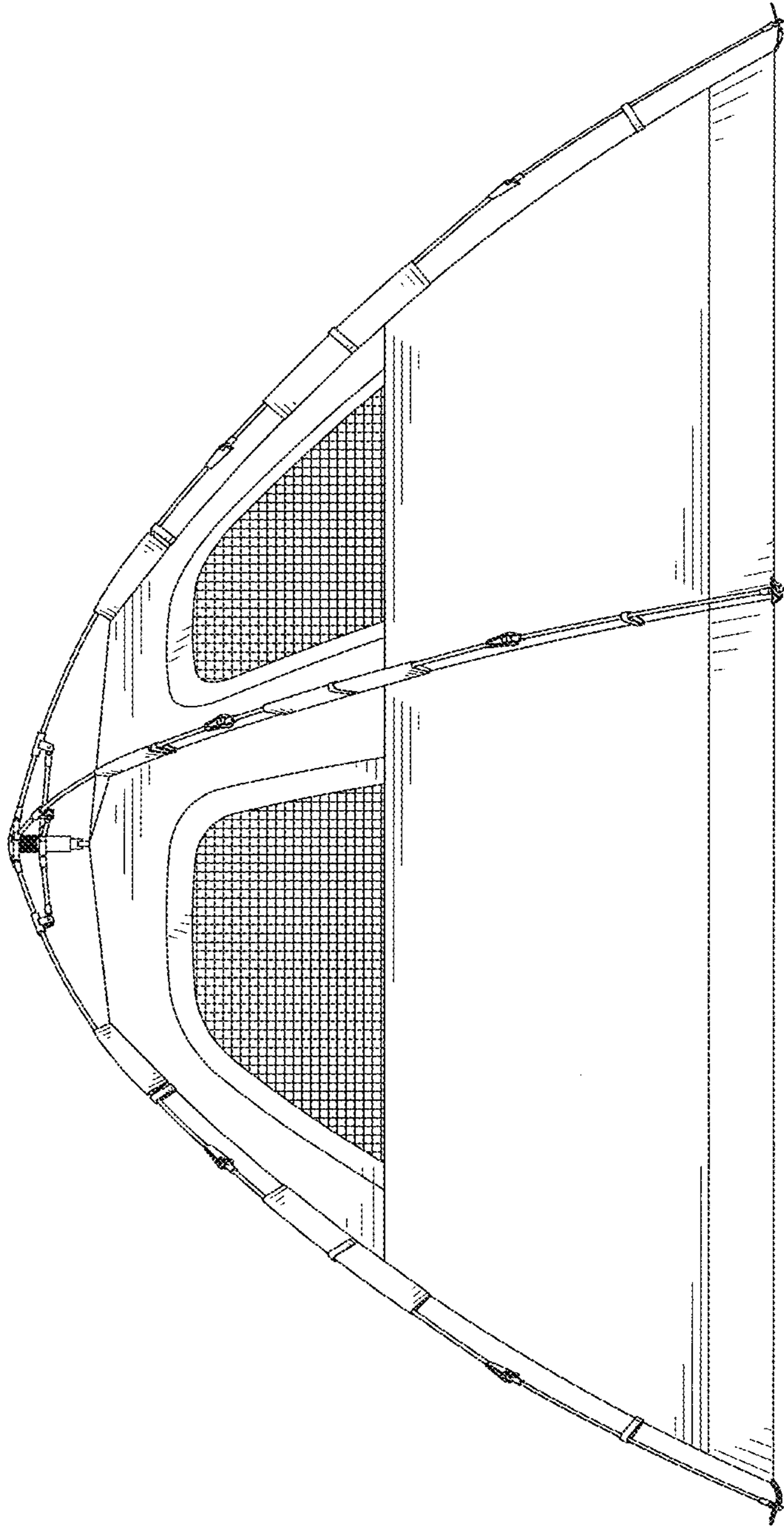

FIG. 6

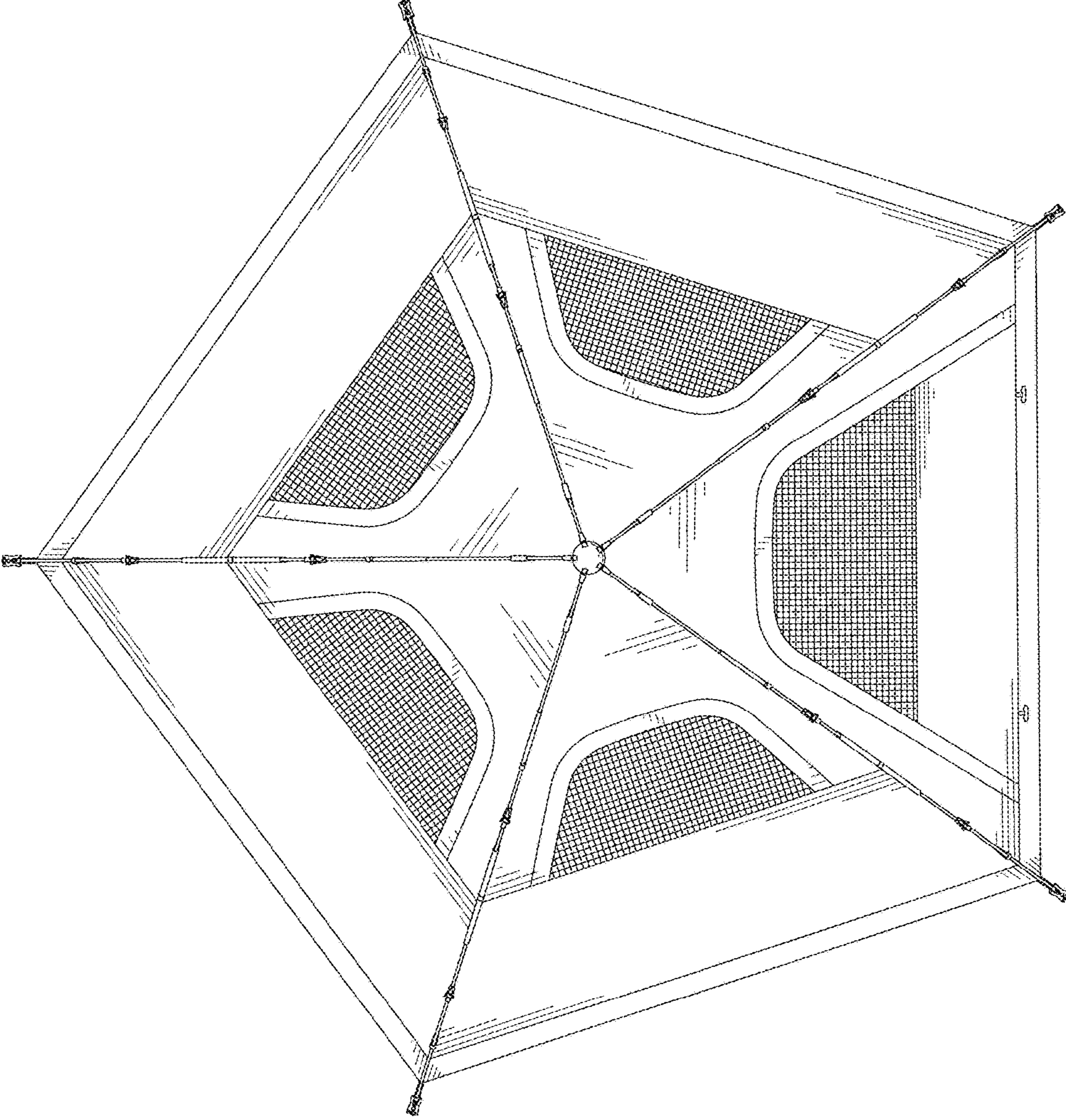

FIG. 7



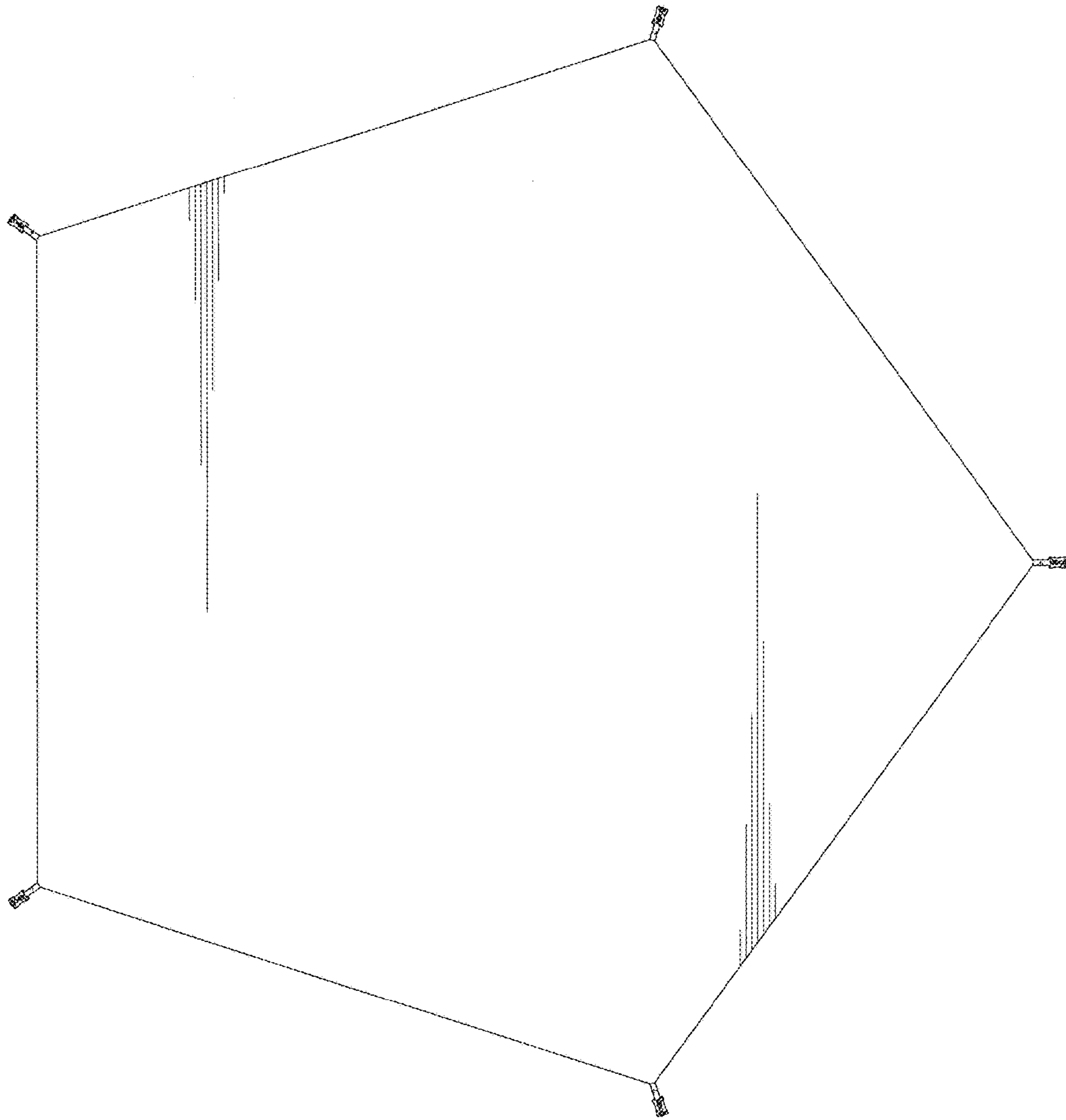

FIG. 8

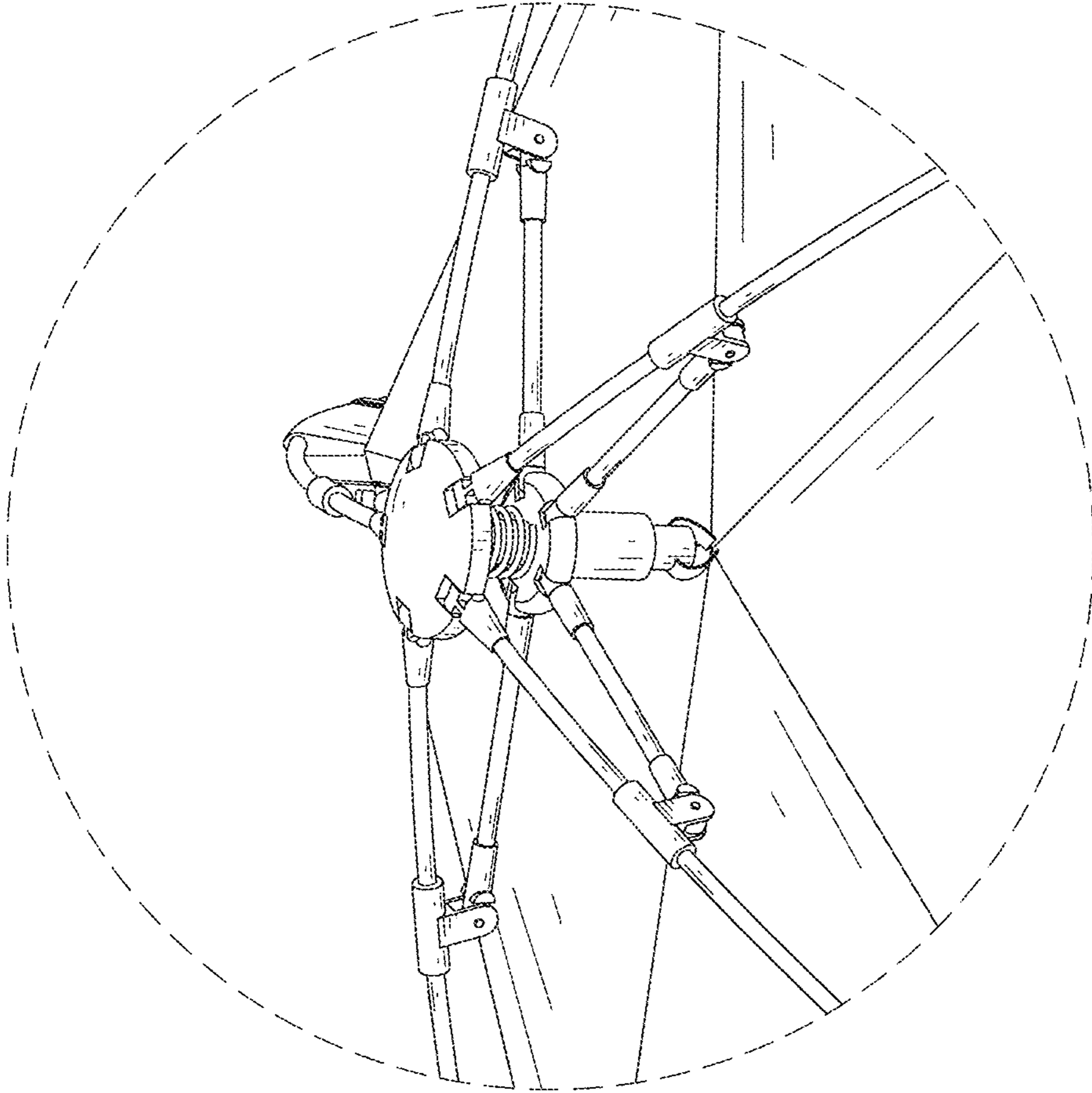

FIG. 9

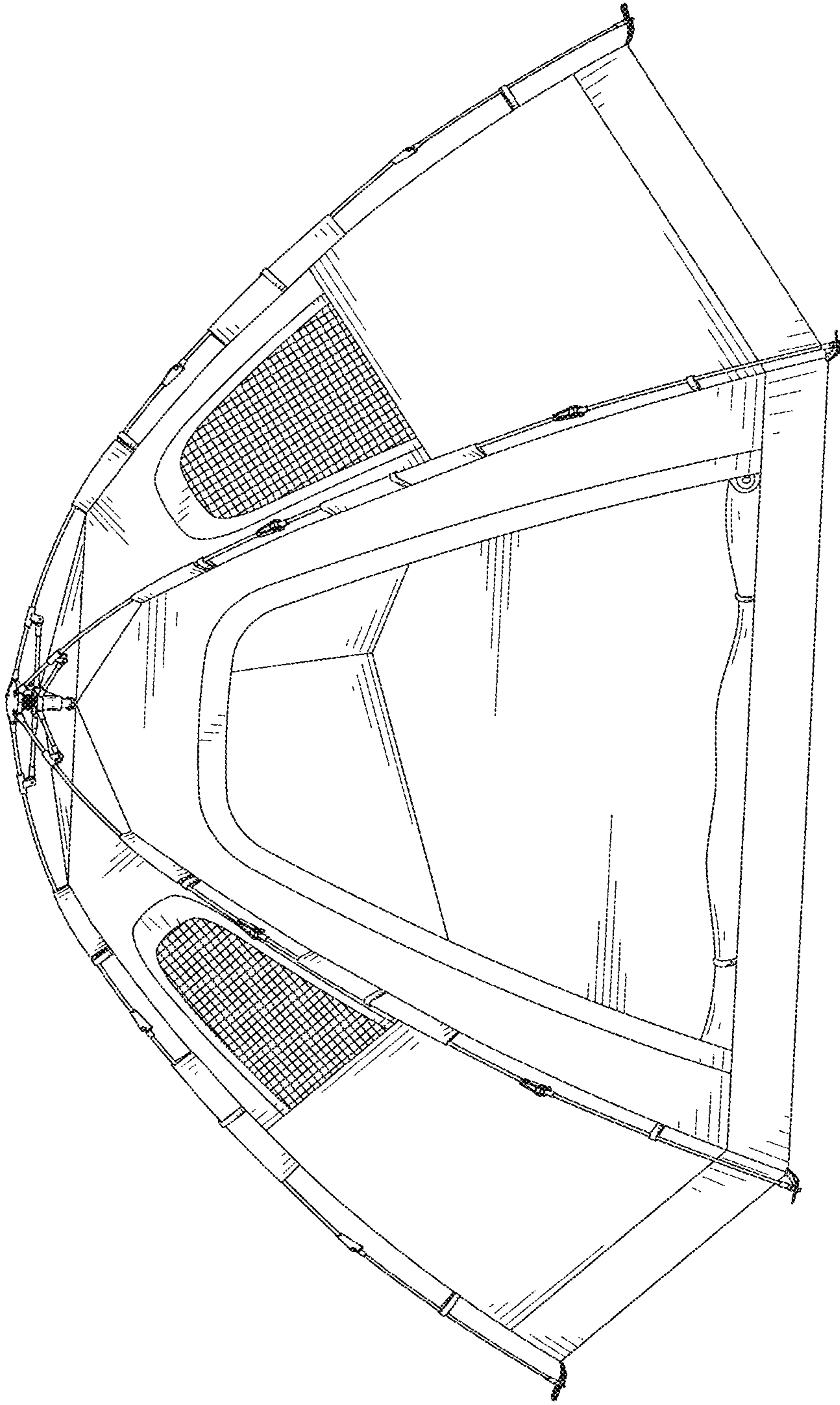

FIG. 10