



US00D921806S

(12) **United States Design Patent** (10) **Patent No.:** **US D921,806 S**
Engler et al. (45) **Date of Patent:** **** Jun. 8, 2021**

(54) **POOL FLOAT**

(71) Applicant: **P&P IMPORTS LLC**, Santa Ana, CA (US)

(72) Inventors: **Peter H Engler**, Newport Beach, CA (US); **Peter L Tanoury**, Newport Beach, CA (US); **Sean Kyne**, Dana Point, CA (US)

(**) Term: **15 Years**

(21) Appl. No.: **29/689,622**

(22) Filed: **Apr. 30, 2019**

(51) **LOC (13) Cl.** **21-02**

(52) **U.S. Cl.**
USPC **D21/808**; D21/803

(58) **Field of Classification Search**
USPC D6/597-599, 601; D12/316; D21/803, D21/805-806, 808, 809
CPC .. A63B 21/4005; A47C 15/006; A47C 15/008
See application file for complete search history.

(56) **References Cited**

U.S. PATENT DOCUMENTS

4,316,287	A *	2/1982	Rule	A47G 9/083
					2/69.5
D437,283	S *	2/2001	Peterson	D12/316
D595,985	S *	7/2009	Su	D6/595
D725,209	S *	3/2015	Wampold	D21/803
D794,738	S *	8/2017	Peterson	D21/803
D813,997	S *	3/2018	McGuire	D23/296
D846,678	S *	4/2019	Arias	D21/803
D859,559	S *	9/2019	Aharon	D21/808
D862,623	S *	10/2019	Hsu	D21/803

OTHER PUBLICATIONS

“AppleRound White Cow Bouncer with Hand Pump” Apr. 16, 2015, Amazon.com, site visited Jun. 8, 2020: <https://www.amazon.com/dp/B00P5V5XO2/> (Year: 2015).*

“Swimline Wildthings Giraffe Pool Float” Aug. 17, 2014, Amazon.com, site visited Jun. 8, 2020: <https://www.amazon.com/dp/B00IGM5GUS/>(Year: 2014).*

“GoFloats Sea Otter Party Tube Inflatable Raft” Jun. 6, 2019, Amazon.com, site visited Jun. 8, 2020: <https://www.amazon.com/dp/B07Q69PZY3/> (Year: 2019).*

CGTRADER—Inflatable Otter 1 3D model, <https://www.cgtrader.com/3d-models/sports/toy/inflatable-otter>, Published at least as early as Apr. 24, 2019.

(Continued)

Primary Examiner — Michael C Stout

Assistant Examiner — Melvin L Davis

(74) *Attorney, Agent, or Firm* — Casey H. Kempner; Siamak S. Hefazi

(57) **CLAIM**

The ornamental design for a pool float, as shown and described.

DESCRIPTION

FIG. 1 is a perspective view of the pool float showing the claimed design;
FIG. 2 is a right-side view of the pool float as shown in FIG. 1;
FIG. 3 is a left-side view of the pool float shown in FIG. 1;
FIG. 4 is a top view of the pool float shown in FIG. 1;
FIG. 5 is a bottom view of the pool float shown in FIG. 1;
FIG. 6 is a front view of the pool float shown in FIG. 1; and,
FIG. 7 is a back view of the pool float shown in FIG. 1.
The broken lines in the figures show portions of the pool float that form no part of the claimed design.

1 Claim, 7 Drawing Sheets

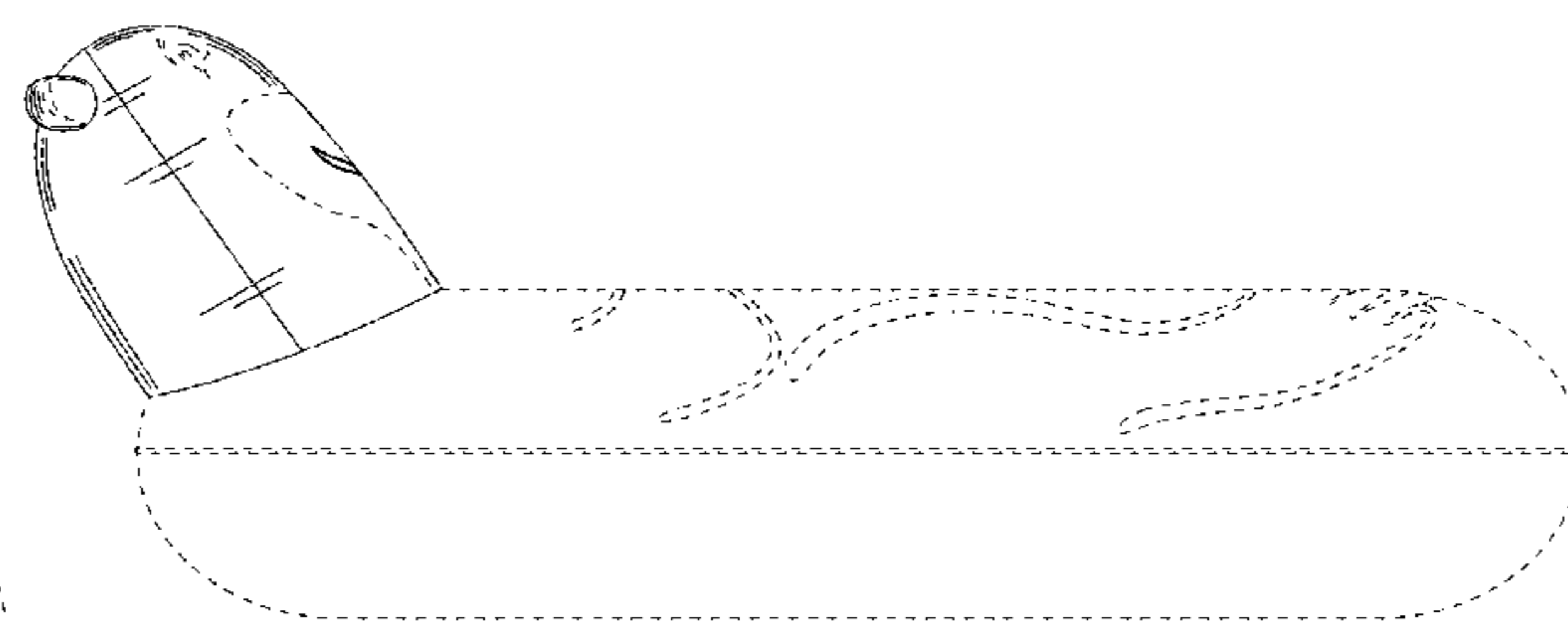
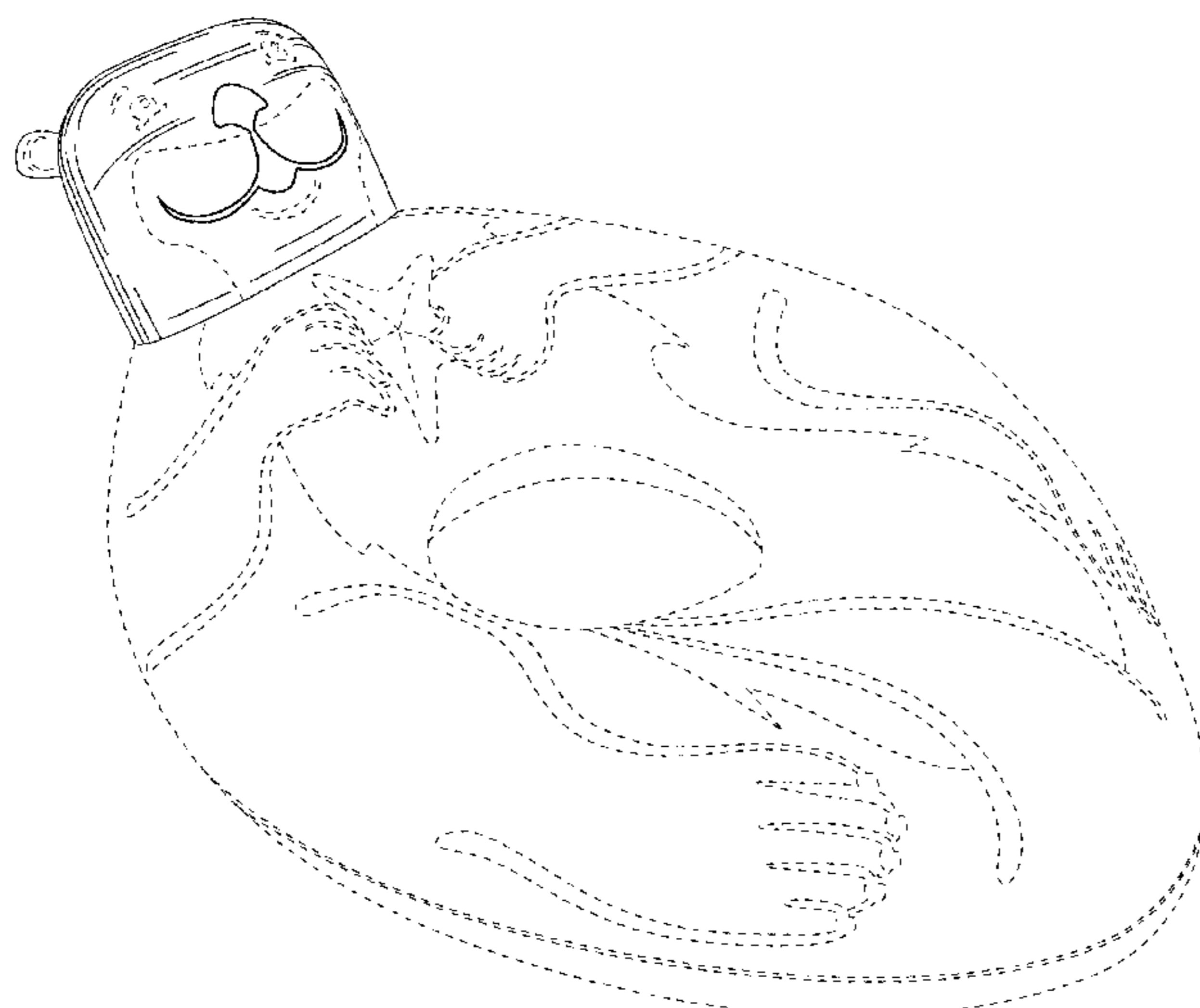

(56)

References Cited

OTHER PUBLICATIONS

Bigmouth, Inc.—Otterly Cute Lil" Float, <https://www.bigmouthinc.com/products/otterly-cute-lil-float/>, Glastonbury, CT 06033, Published at least as early as: Mar. 21, 2019.

Game—Game Inflatable Otter Pool Ring Float, <https://www.amazon.com/GAME-Inflatable-Otter-Pool-Float/dp/B07BX9Q1F6>, Published at least as early as Mar. 21, 2019.

* cited by examiner

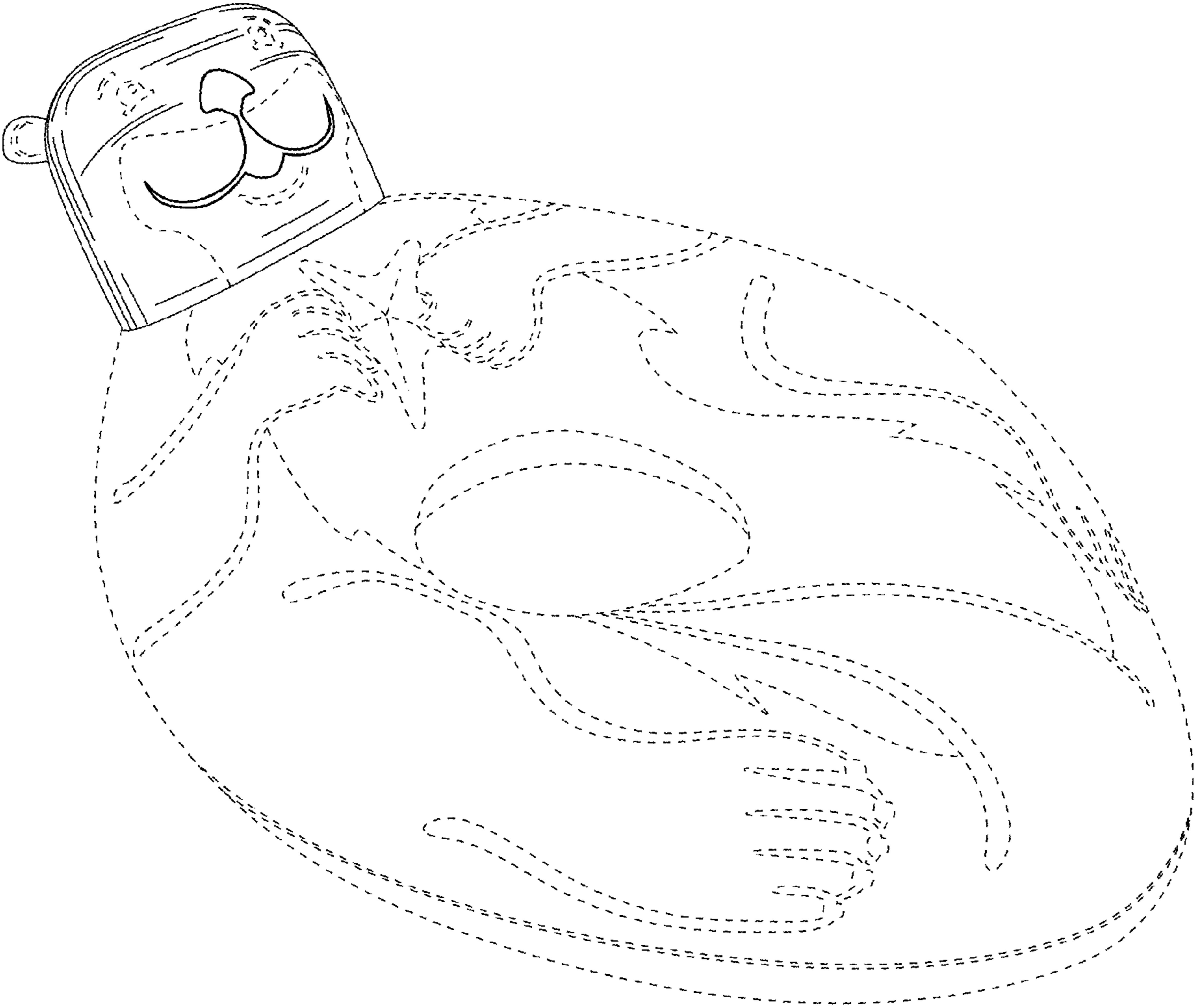

FIG. 1

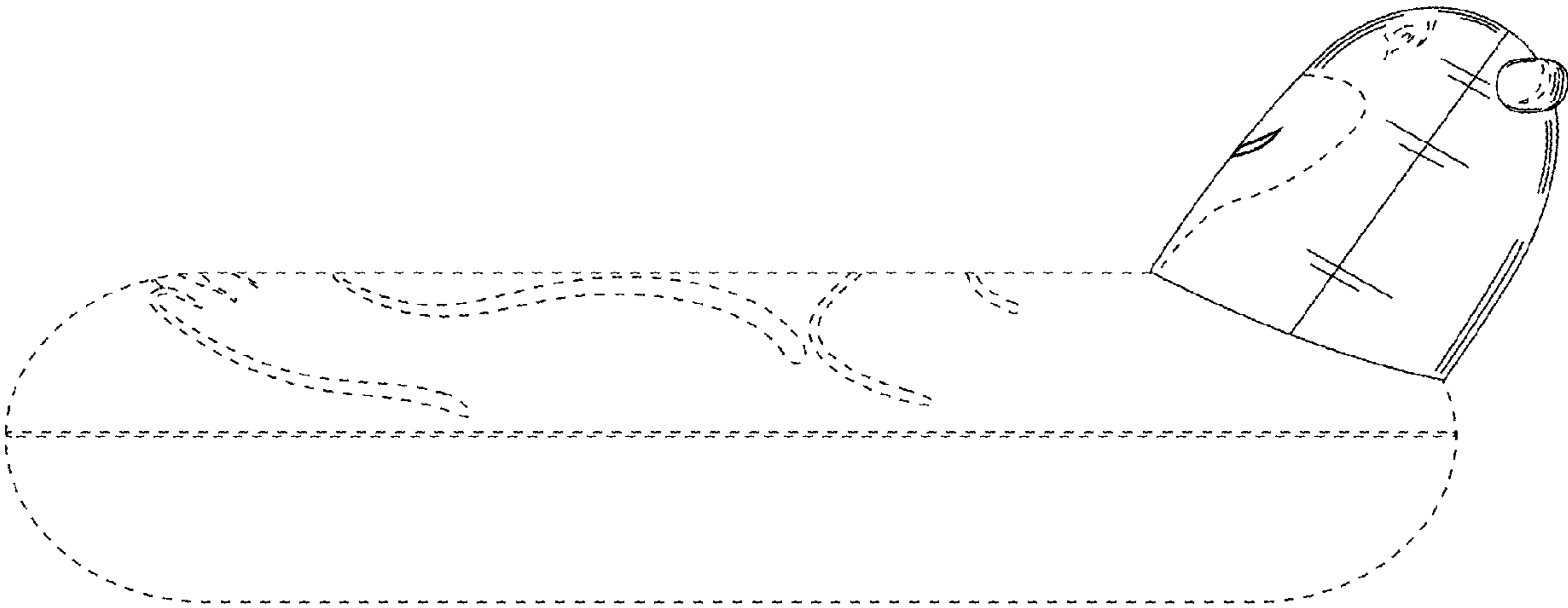

FIG. 2

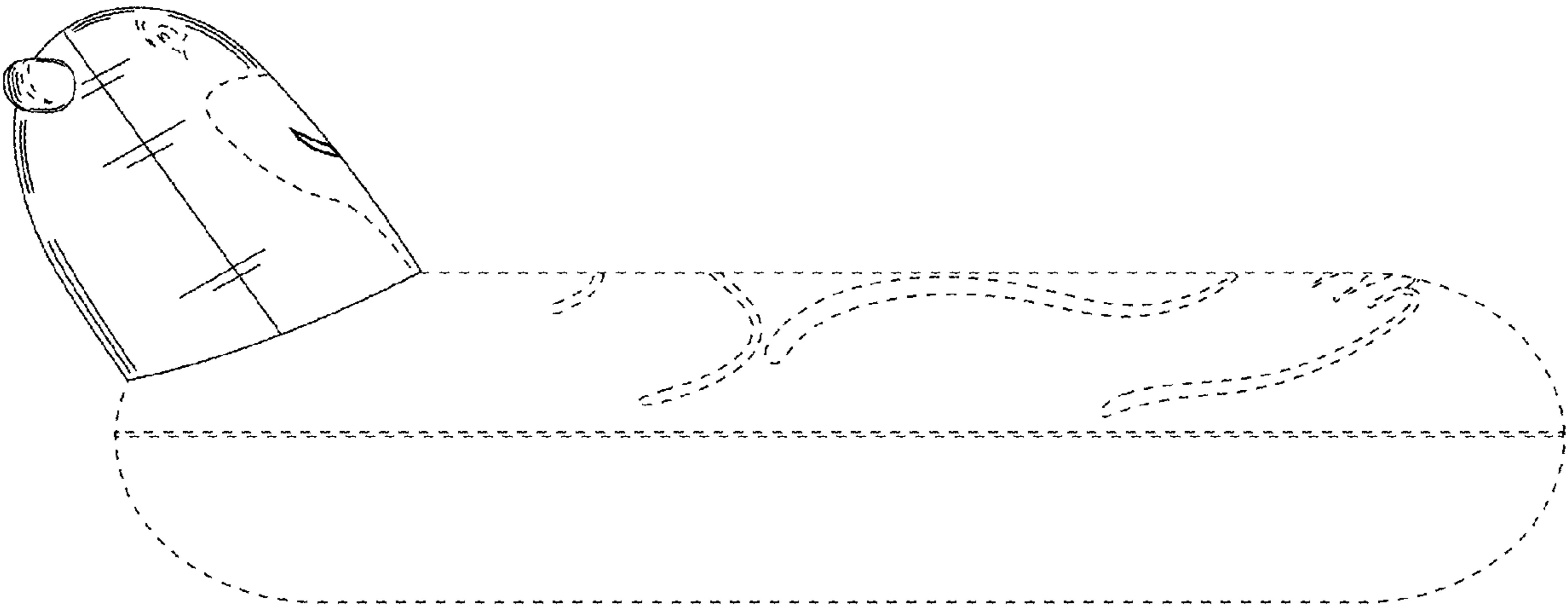

FIG. 3

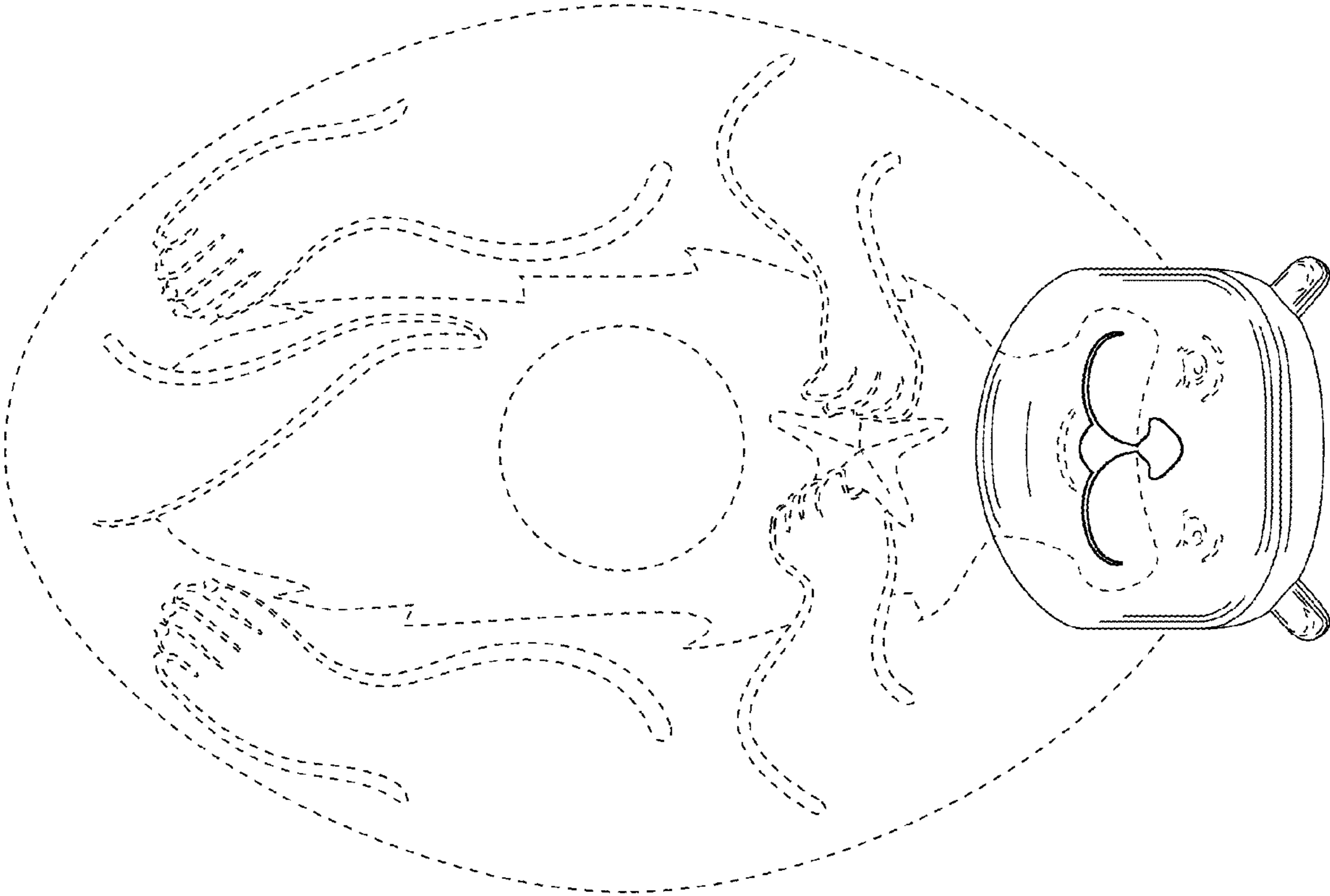

FIG. 4

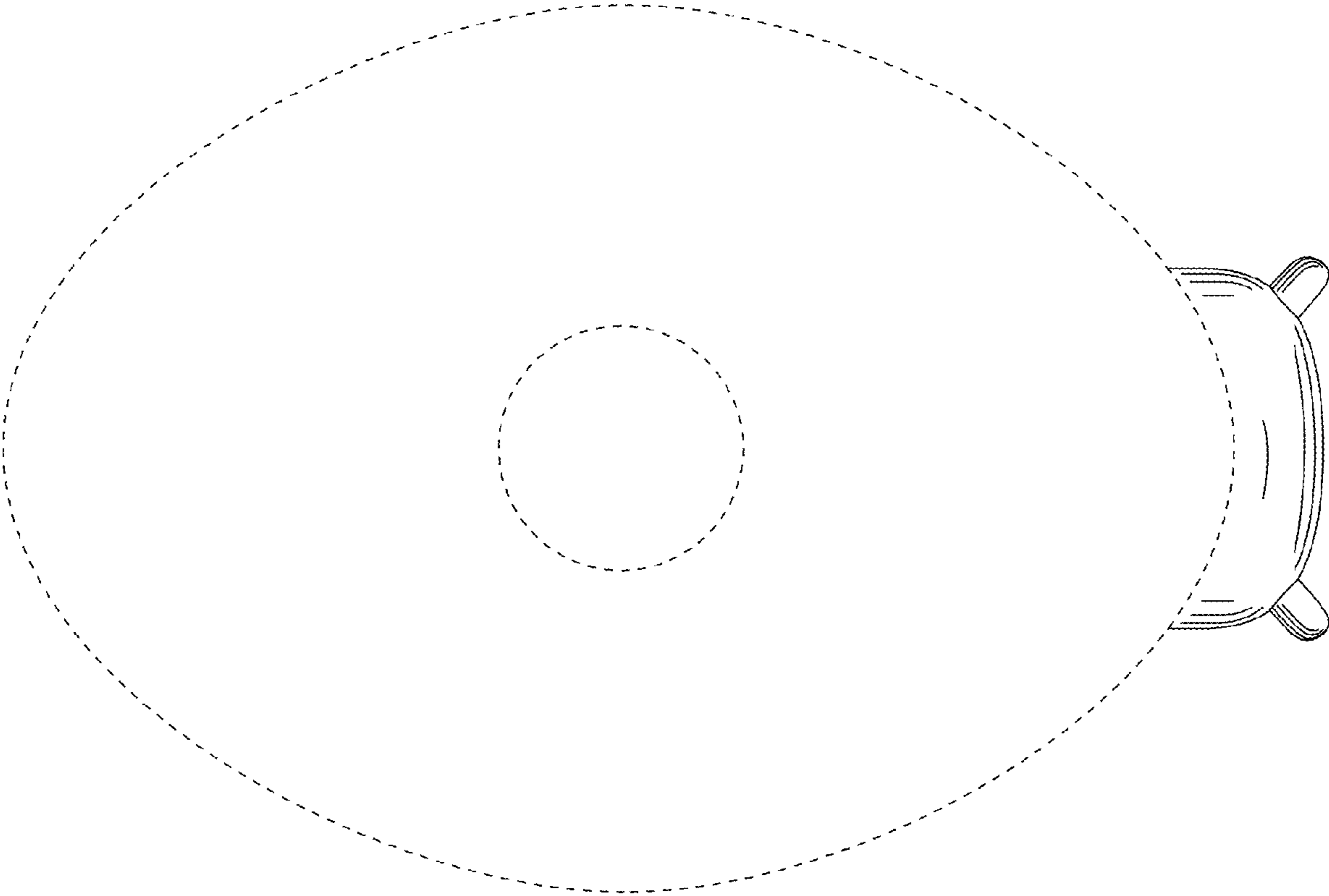

FIG. 5

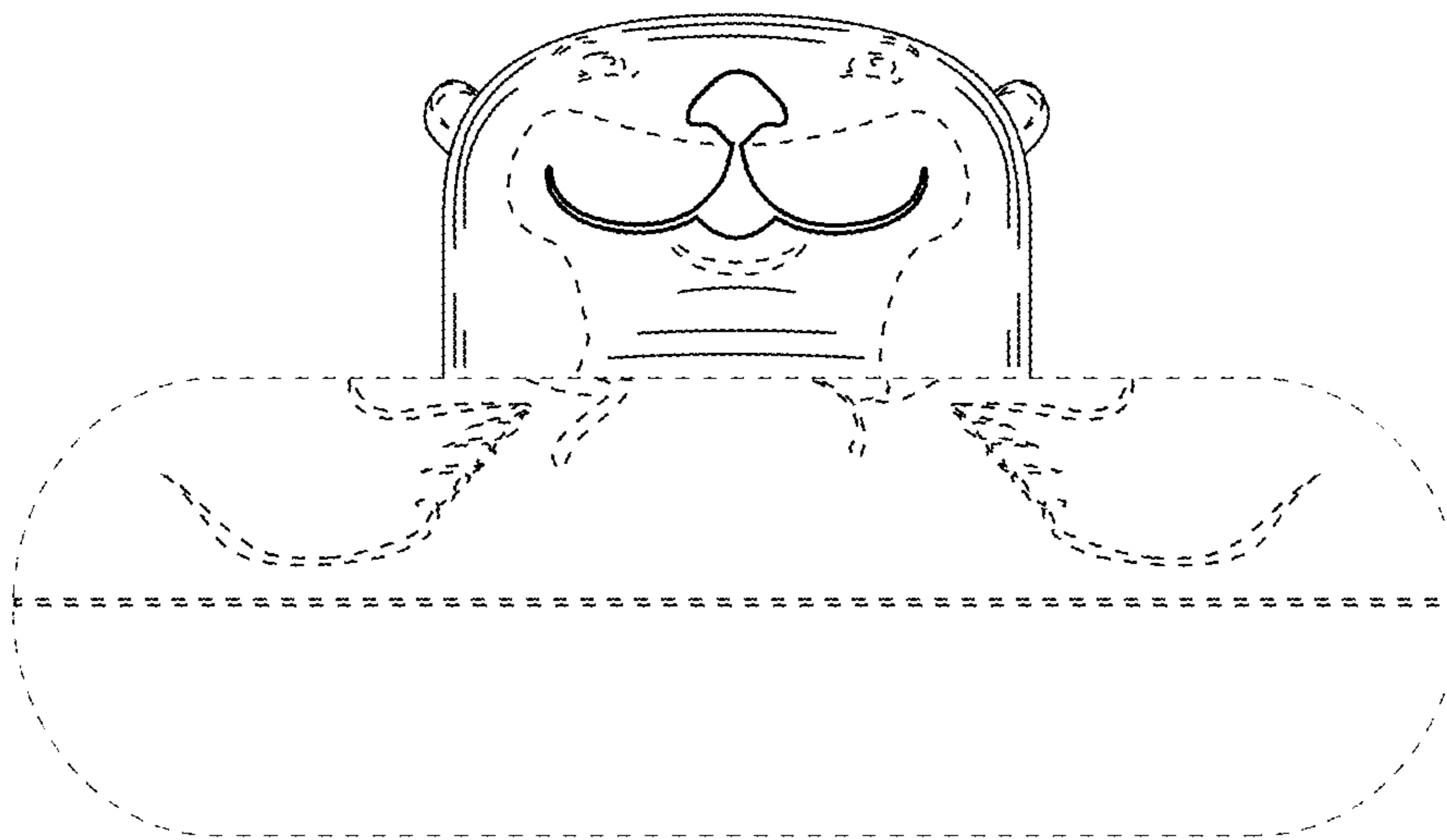

FIG. 6

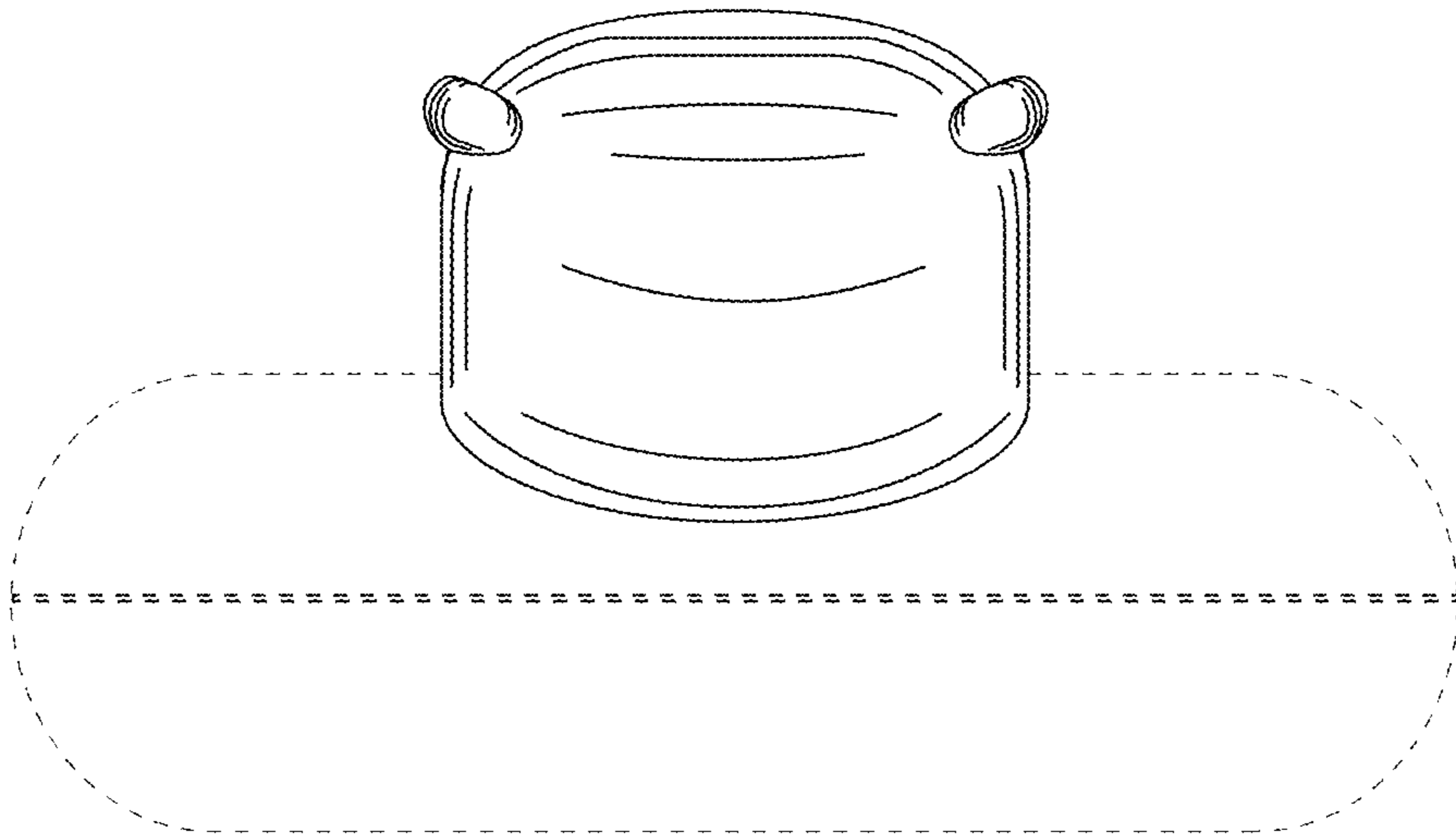

FIG. 7