



US00D921802S

(12) **United States Design Patent**
West et al.

(10) **Patent No.: US D921,802 S**

(45) **Date of Patent: ** Jun. 8, 2021**

(54) **CUFF FOR SURF LEASH**

(71) Applicant: **Dakine IP Holdings LP**, New York, NY (US)

(72) Inventors: **Zachary West**, Seattle, WA (US); **John Martin**, Vashon, WA (US); **Brian Fletcher**, Issaquah, WA (US); **Mirona Motoc**, Seattle, WA (US); **Jay Willet**, Tacoma, WA (US); **Aaron Ambuske**, Seattle, WA (US)

(73) Assignee: **Dakine IP Holdings LP**, New York, NY (US)

(**) Term: **15 Years**

(21) Appl. No.: **29/682,806**

(22) Filed: **Mar. 7, 2019**

(51) **LOC (13) Cl.** **21-02**

(52) **U.S. Cl.**
USPC **D21/774**

(58) **Field of Classification Search**
USPC D21/684–685, 760–761, 765–766, D21/768–777; D3/215, 327; D28/41
(Continued)

(56) **References Cited**

U.S. PATENT DOCUMENTS

4,265,448 A 5/1981 Anderson, Jr.
4,610,634 A 9/1986 Kimura
(Continued)

FOREIGN PATENT DOCUMENTS

JP 09-76990 A 3/1997
WO 2017139840 A1 8/2017
WO 2017181225 A1 10/2017

OTHER PUBLICATIONS

Quality Surfboards Hawaii, "Introducing the Kaimana", Online, Mar. 6, 2020, Retrieved from the Internet on Apr. 30, 2020,

https://www.youtube.com/watch?time_con, tinue=1&v=b8hyBMrg-eM&feature=emb_logo, 1 page.

U.S. Receiving Office of WIPO, International Search Report and Written Opinion regarding PCT Patent Application No. PCT/US2020/019998, dated Jun. 10, 2020, 10 pages.

Primary Examiner — Zenia I Bennett

(74) *Attorney, Agent, or Firm* — Kolisch Hartwell, P.C.

(57) **CLAIM**

The ornamental design for a cuff for surf leash, as shown.

DESCRIPTION

FIG. 1 is a front perspective view of a cuff for surf leash in a flat configuration, showing the new design;
FIG. 2 is a front elevation view showing the outer side thereof;
FIG. 3 is a rear elevation view showing the inner side thereof;
FIG. 4 is a right side elevation view thereof;
FIG. 5 is a left side elevation view thereof;
FIG. 6 is a top plan view thereof;
FIG. 7 is a bottom plan view thereof;
FIG. 8 is a front and right side perspective view of a cuff for surf leash in a curled configuration, showing the new design;
FIG. 9 is a front elevation view thereof;
FIG. 10 is a rear elevation view thereof;
FIG. 11 is a right side elevation view thereof;
FIG. 12 is a left side elevation view thereof;
FIG. 13 is a top plan view thereof;
FIG. 14 is a bottom plan view thereof;
FIG. 15 is a rear and right side perspective view thereof;
FIG. 16 is a front perspective view of a cuff for surf leash in a flat configuration, showing the new design;
FIG. 17 is a front elevation view showing the outer side thereof;
FIG. 18 is a rear elevation view showing the inner side thereof;
FIG. 19 is a right side elevation view thereof;
FIG. 20 is a left side elevation view thereof;
FIG. 21 is a top plan view thereof;
FIG. 22 is a bottom plan view thereof;

(Continued)

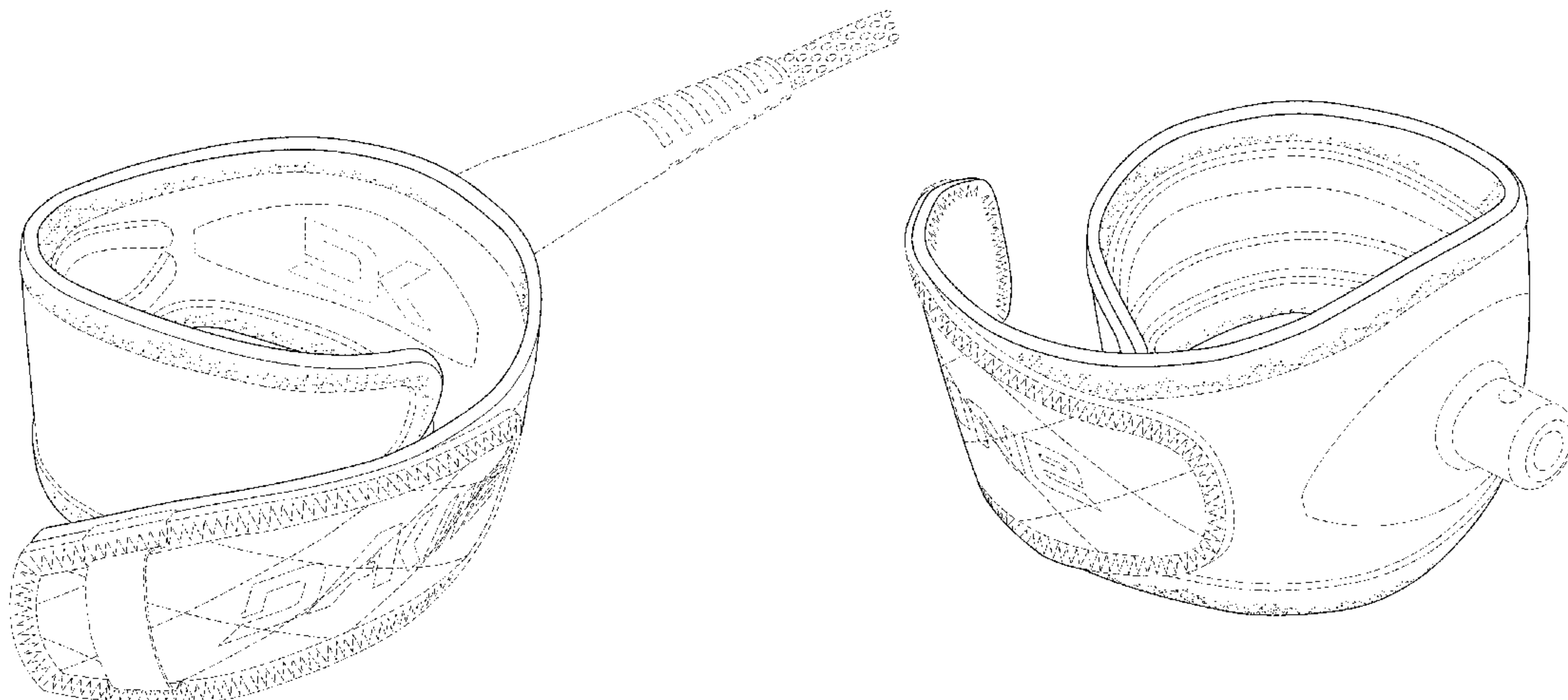

FIG. **23** is a front and right side perspective view of a cuff for surf leash in a curled configuration, showing the new design; (56)

FIG. **24** is a front elevation view thereof;

FIG. **25** is a rear elevation view thereof;

FIG. **26** is a right side elevation view thereof;

FIG. **27** is a left side elevation view thereof;

FIG. **28** is a top plan view thereof;

FIG. **29** is a bottom plan view thereof; and,

FIG. **30** is a rear and right side perspective view thereof. The broken lines and structures they depict form no part of the claimed design.

1 Claim, 18 Drawing Sheets

(58) **Field of Classification Search**
 CPC B63B 35/7936; B63B 35/7933; B63B 35/794
 See application file for complete search history.

References Cited

U.S. PATENT DOCUMENTS

5,643,028	A	7/1997	Craig	
5,775,965	A	7/1998	Hango	
6,000,979	A	12/1999	Stewart	
6,471,560	B2	10/2002	Kerckhoff	
6,500,039	B1	12/2002	Underwood	
7,708,612	B2 *	5/2010	Wardle	B63B 32/70 441/75
7,918,699	B2	4/2011	Malloy	
8,834,221	B2 *	9/2014	Cregan	A01K 27/003 441/75
8,894,457	B1 *	11/2014	Crozier	B63B 32/70 441/75
9,456,826	B2 *	10/2016	Henderson	A61B 17/1325
10,737,750	B2 *	8/2020	Lundstedt, Jr.	B63B 32/70
2006/0014450	A1	1/2006	Crumrine	
2008/0098965	A1	5/2008	Hachigian	
2012/0244763	A1	9/2012	Cregan	
2019/0106839	A1	4/2019	Norrie et al.	

* cited by examiner

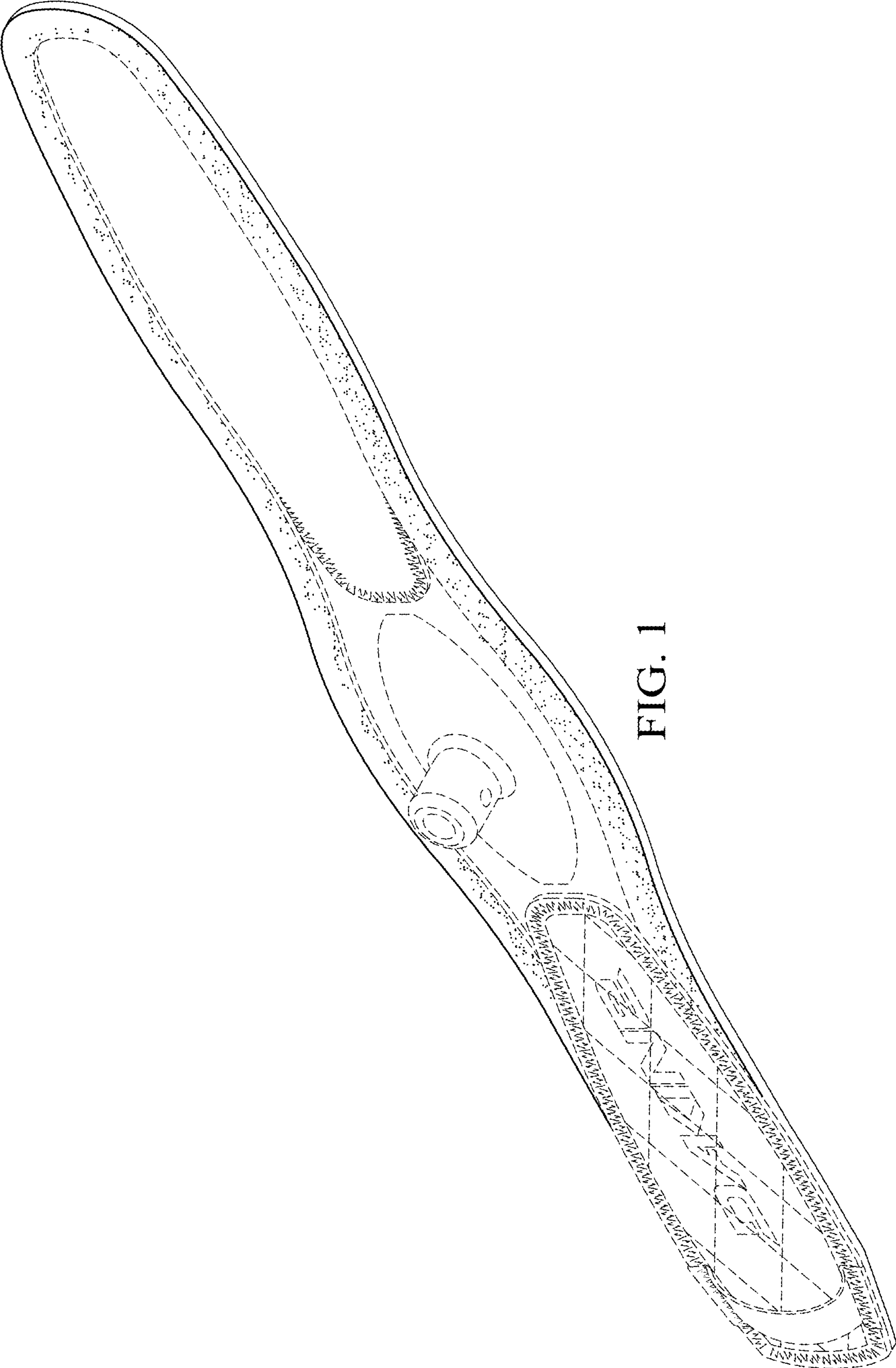

FIG. 1

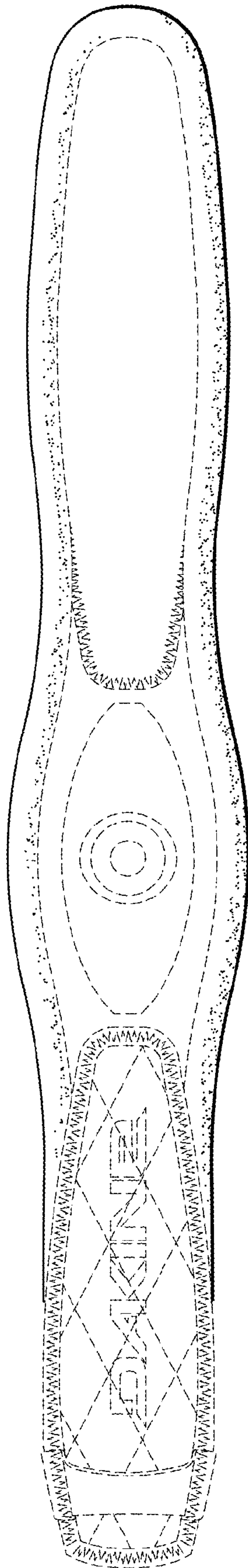

FIG. 2

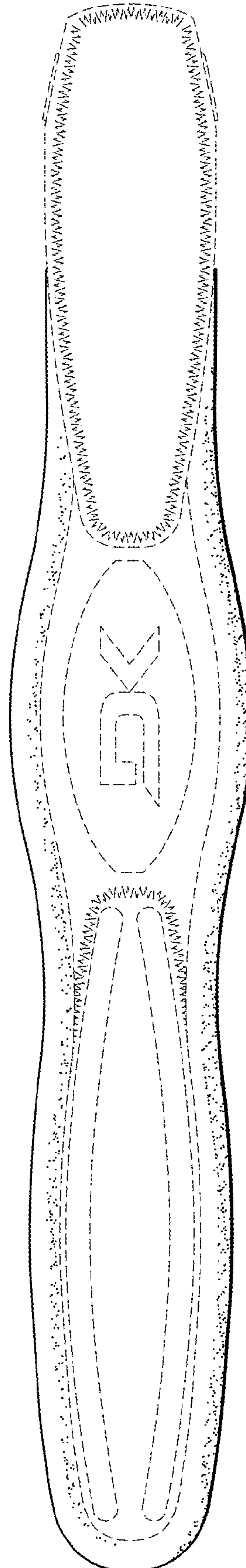

FIG. 3

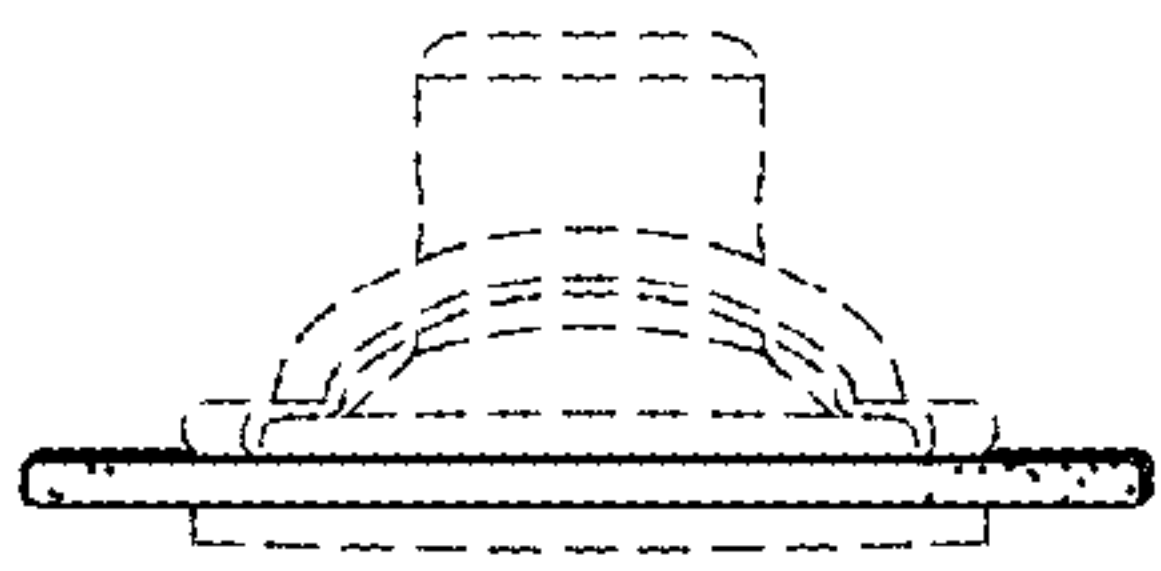

FIG. 5

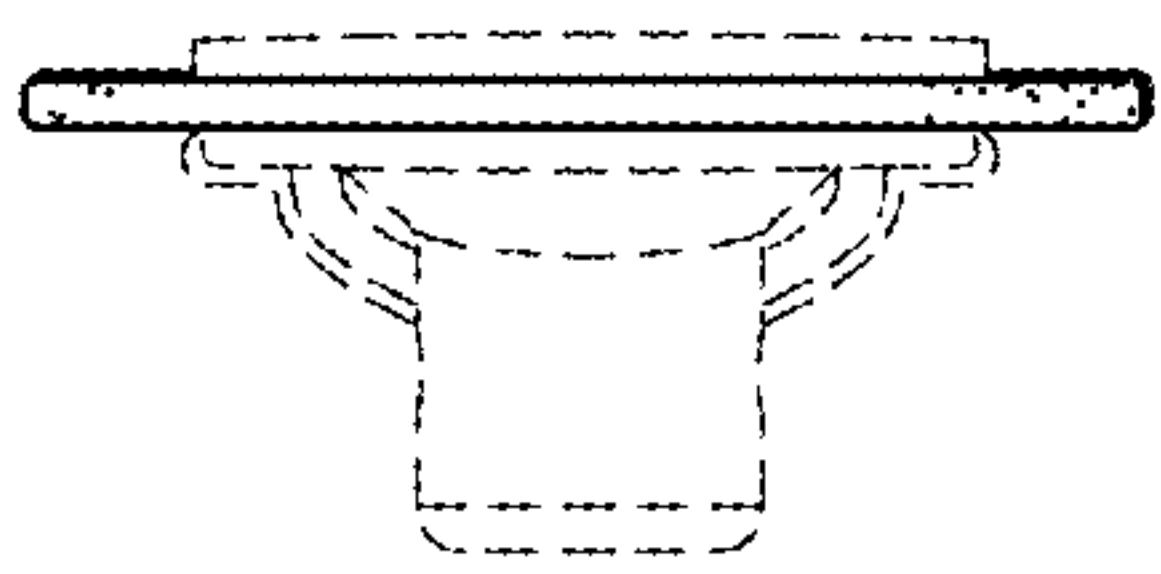

FIG. 4



FIG. 6

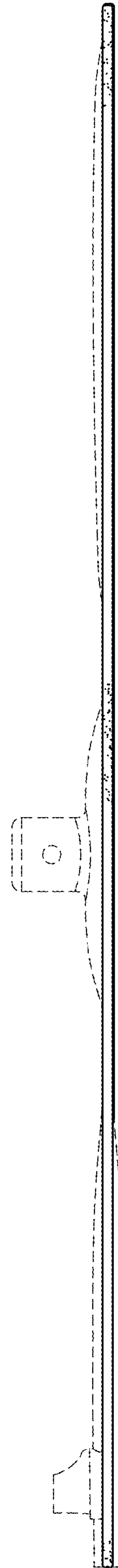

FIG. 7

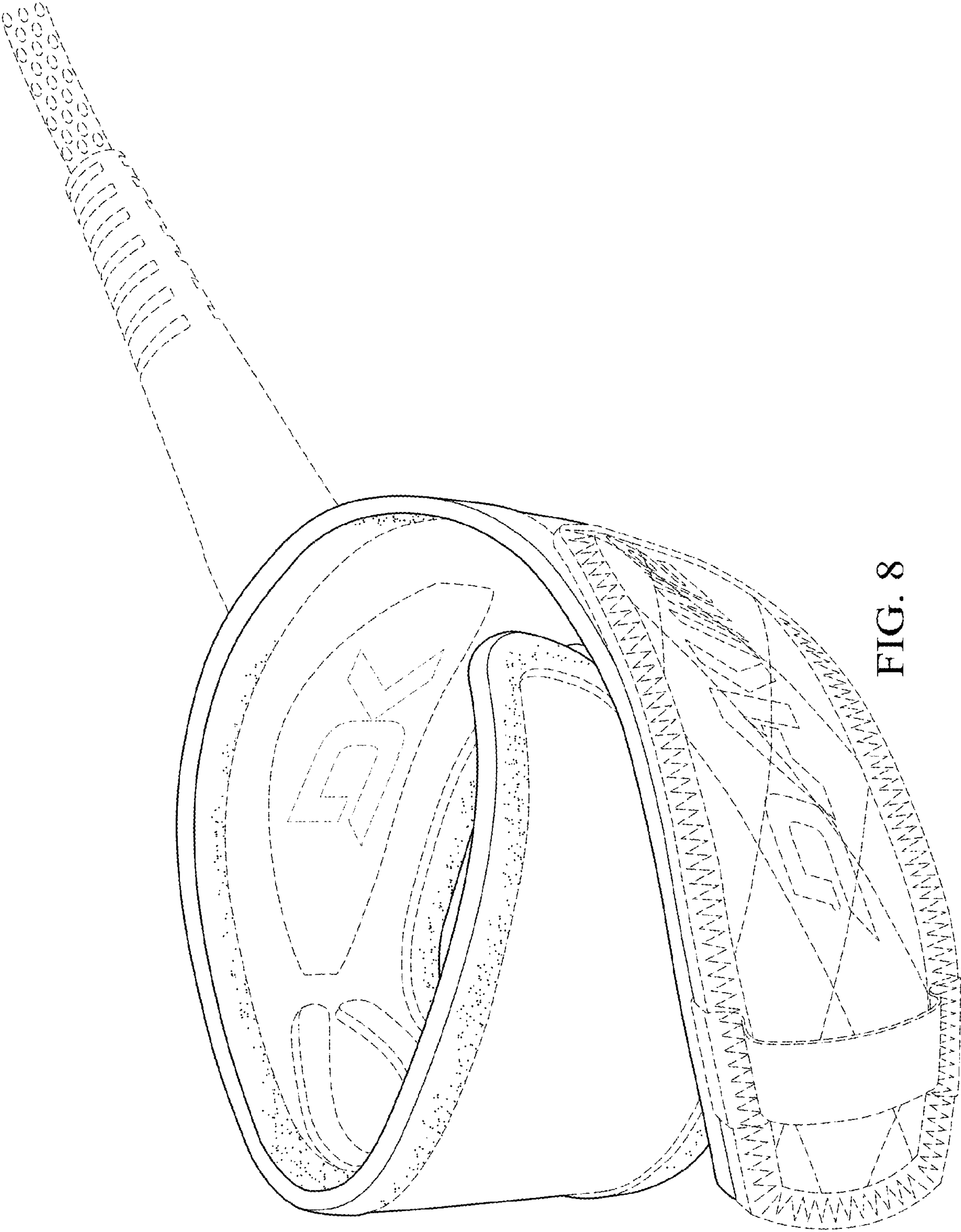

FIG. 8

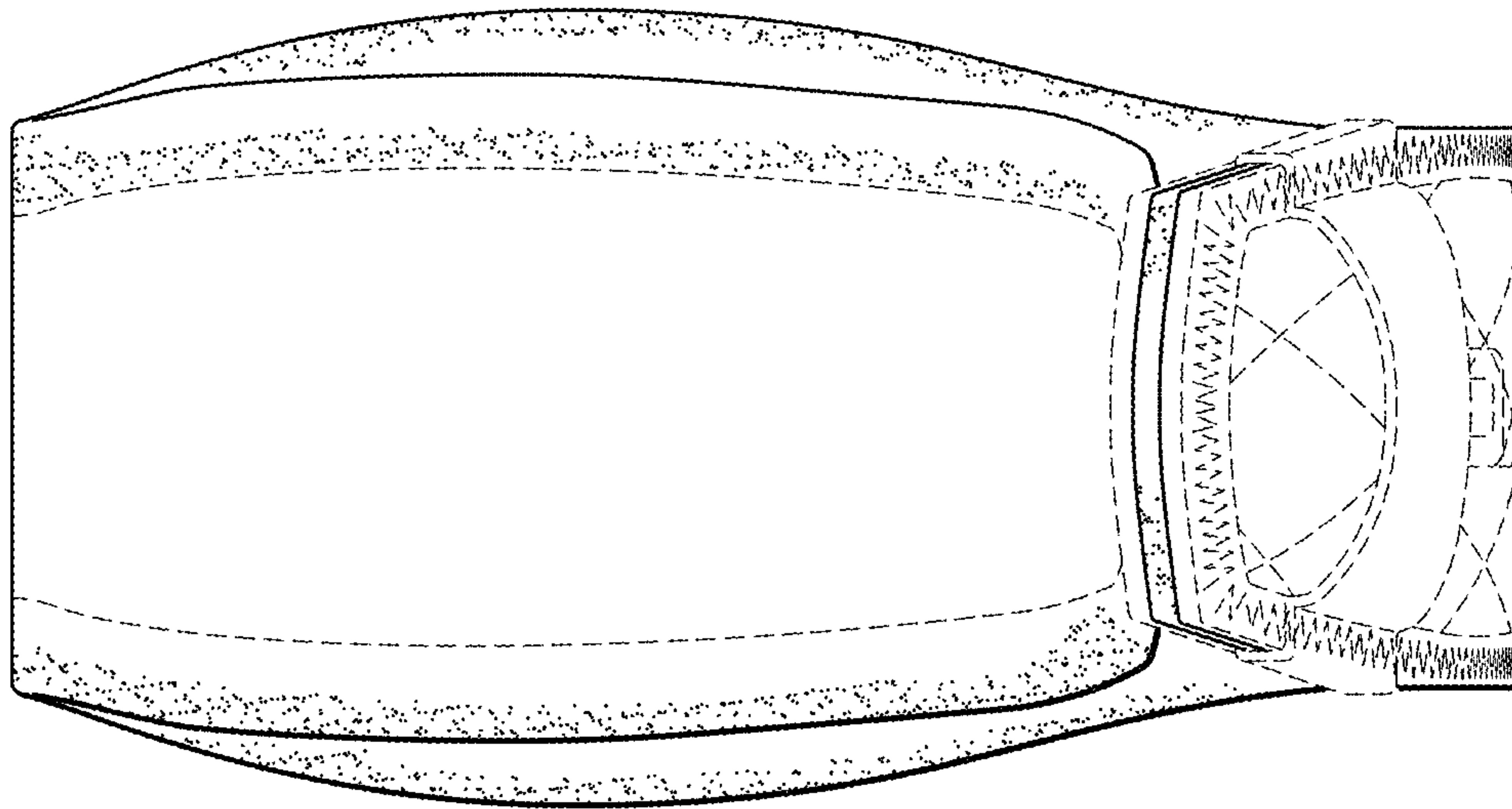

FIG. 9

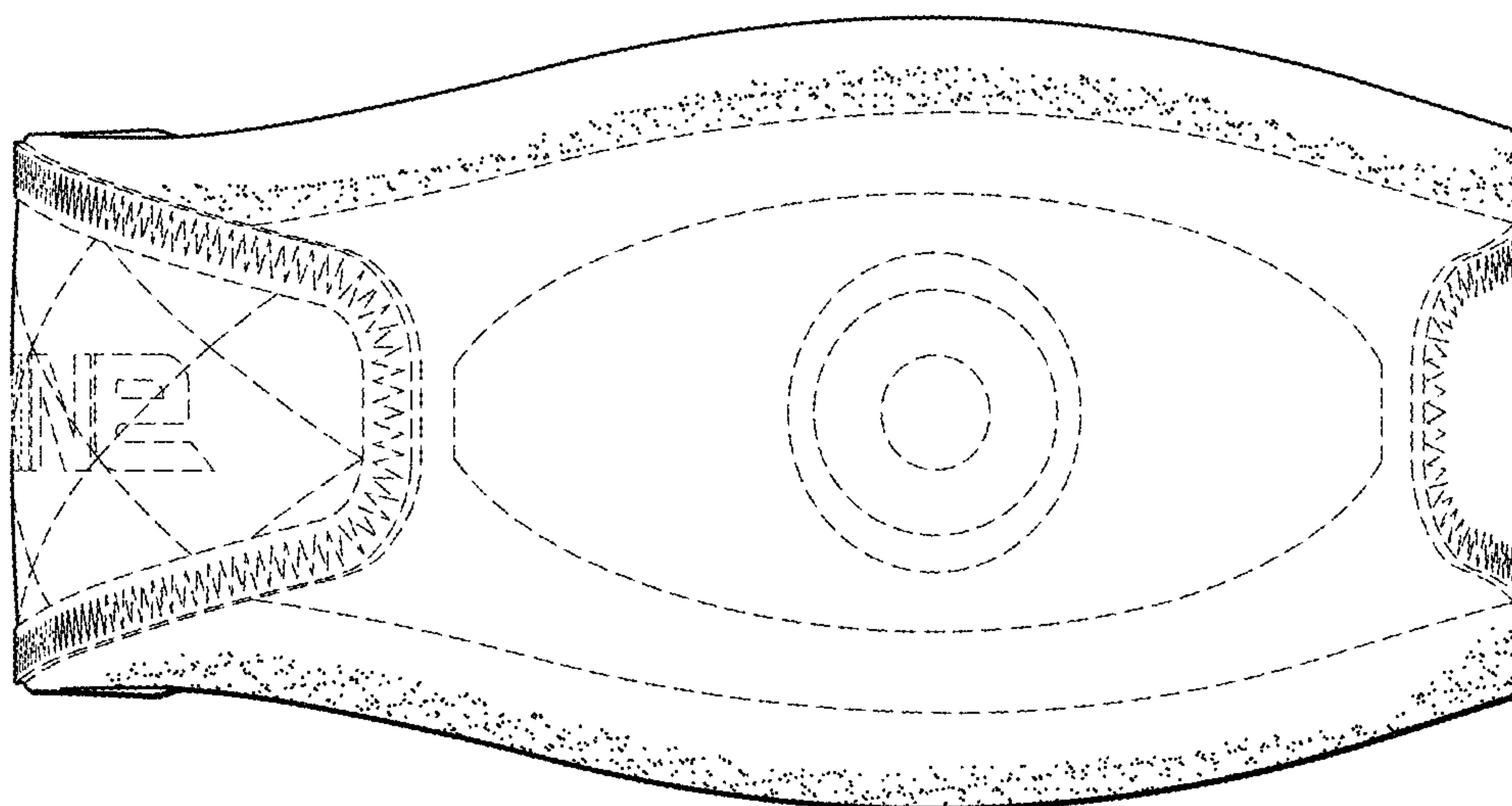

FIG. 10

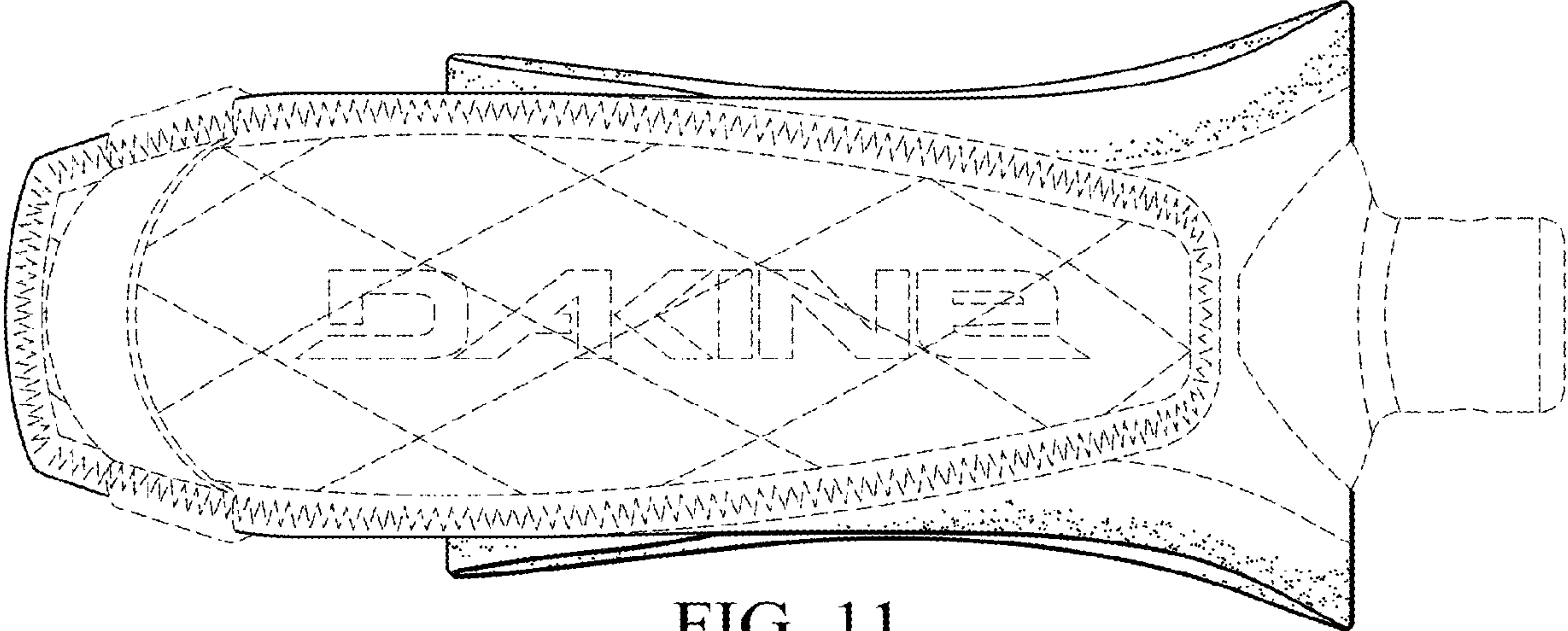

FIG. 11

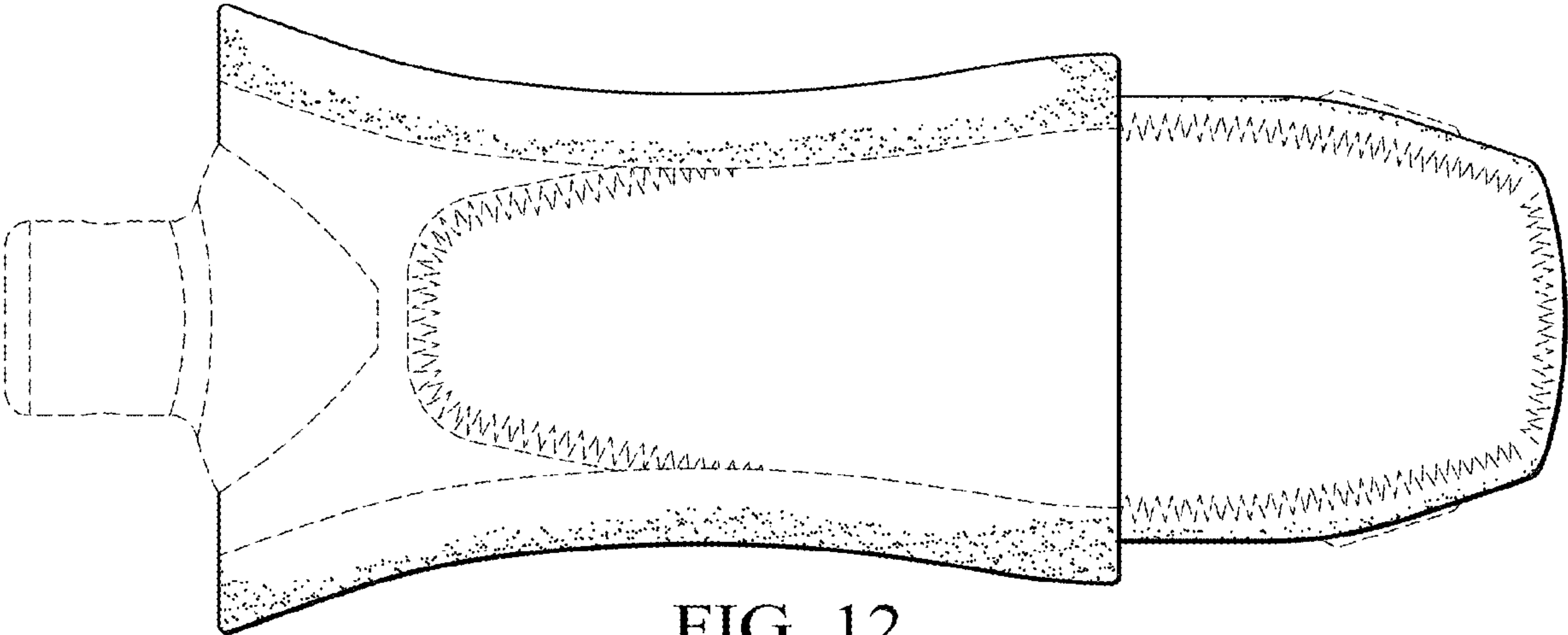

FIG. 12

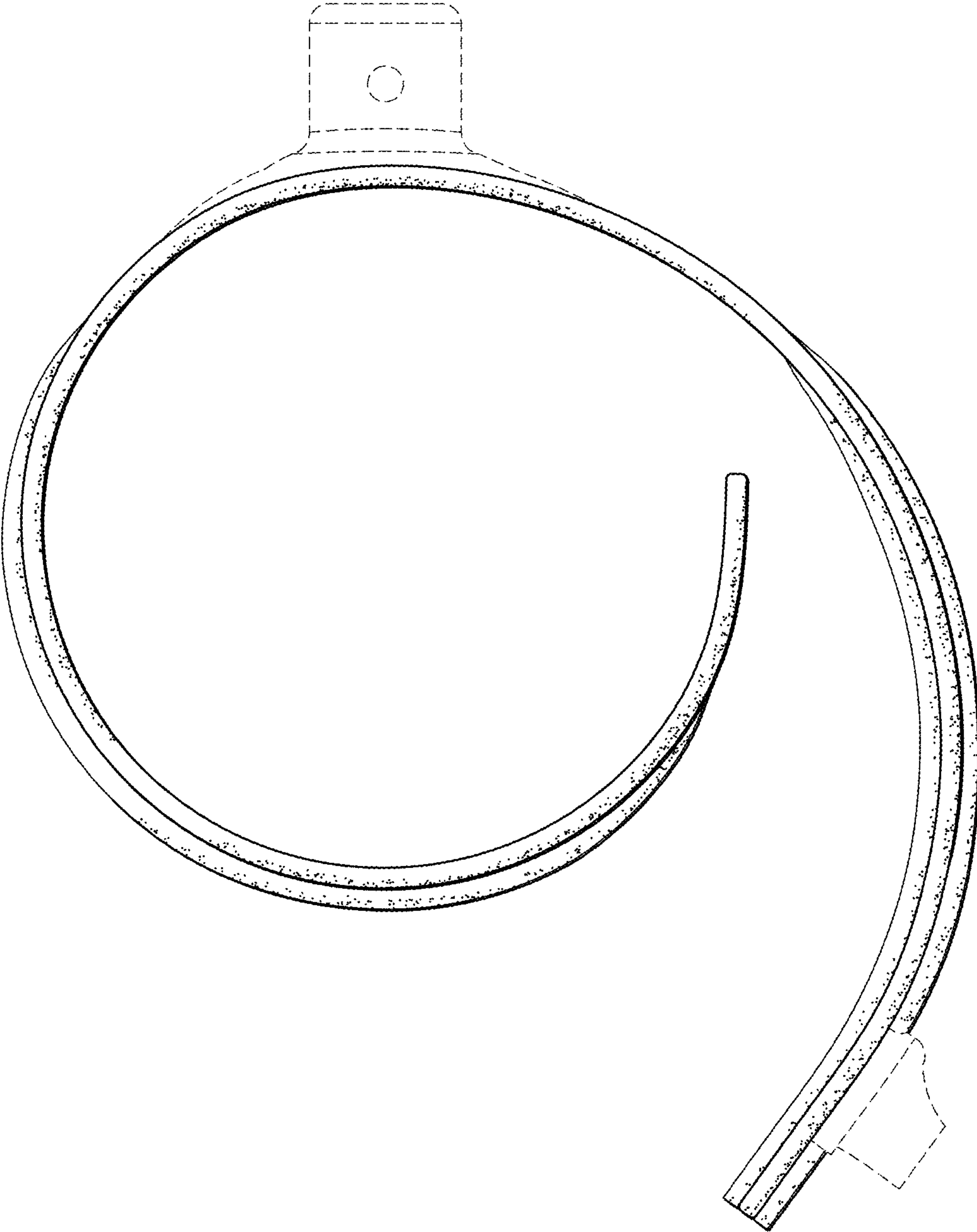

FIG. 13

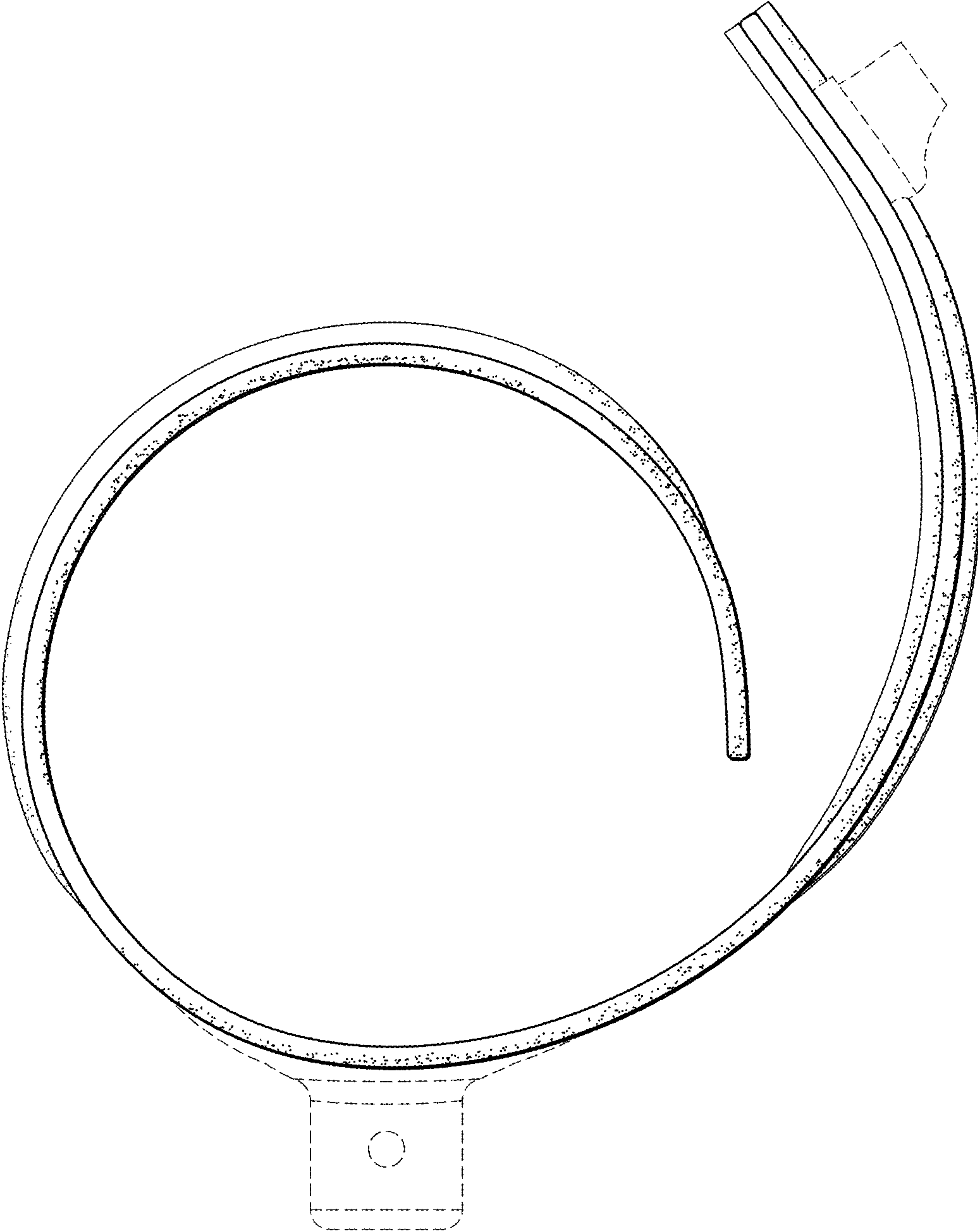

FIG. 14

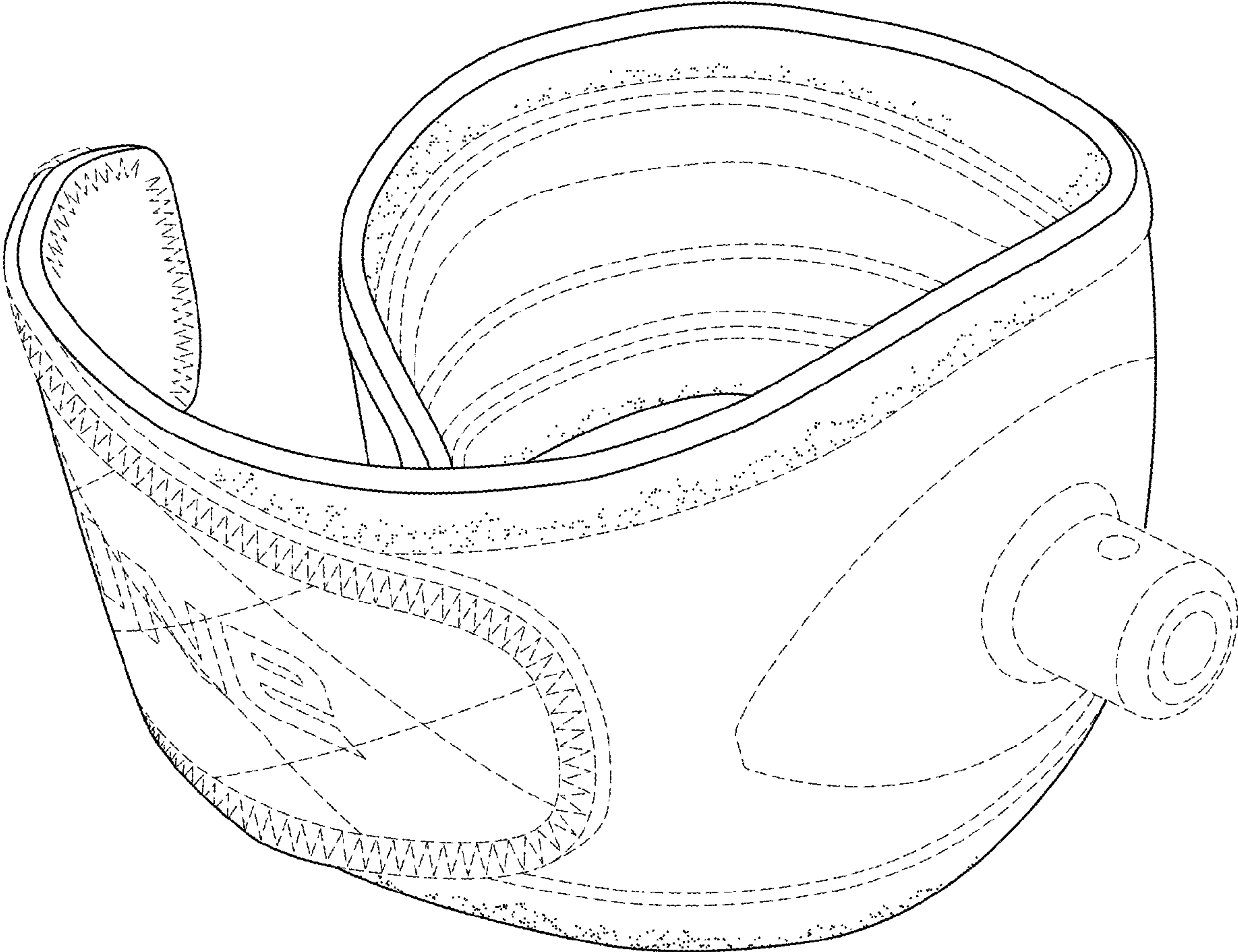

FIG. 15

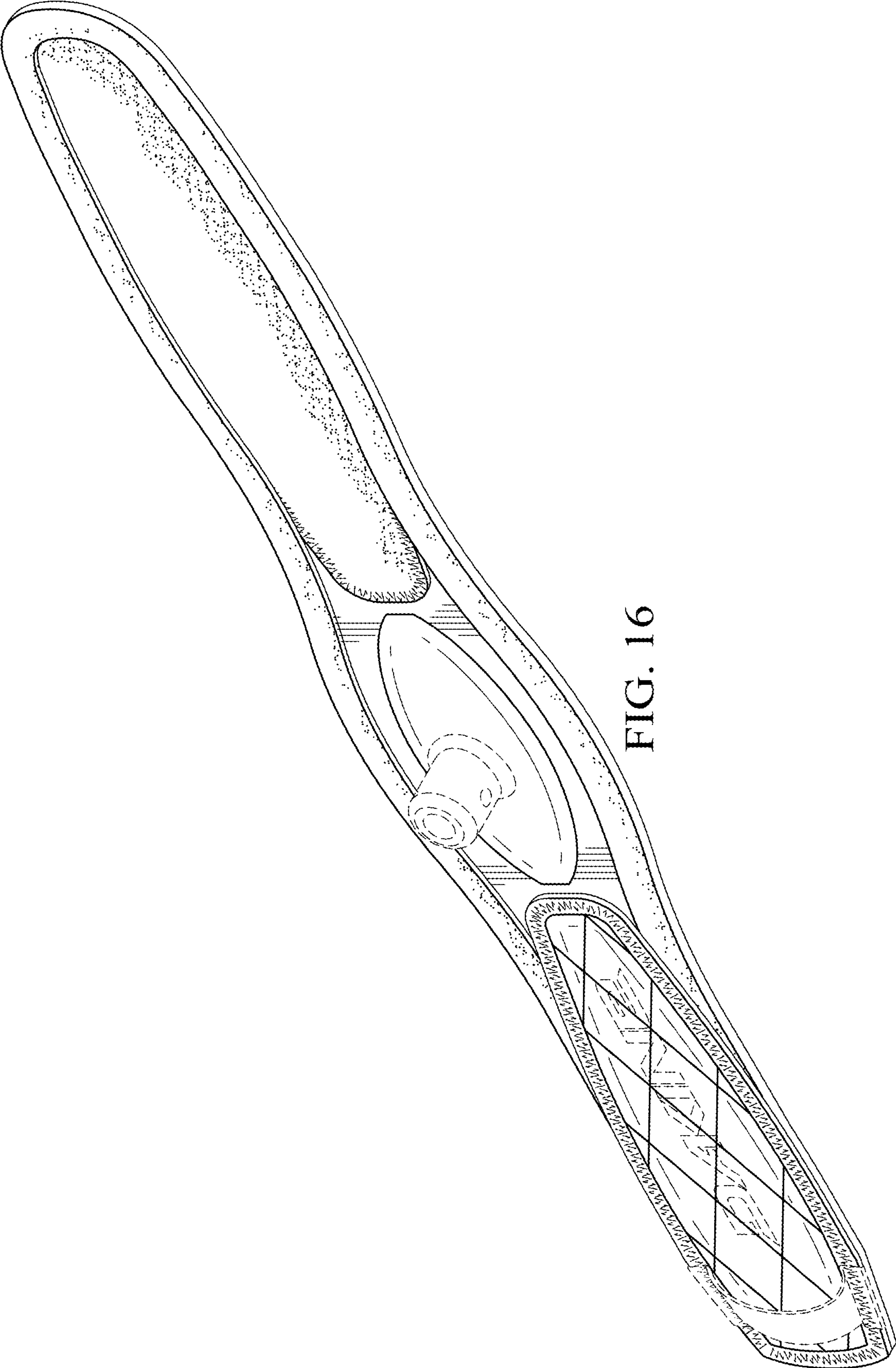

FIG. 16

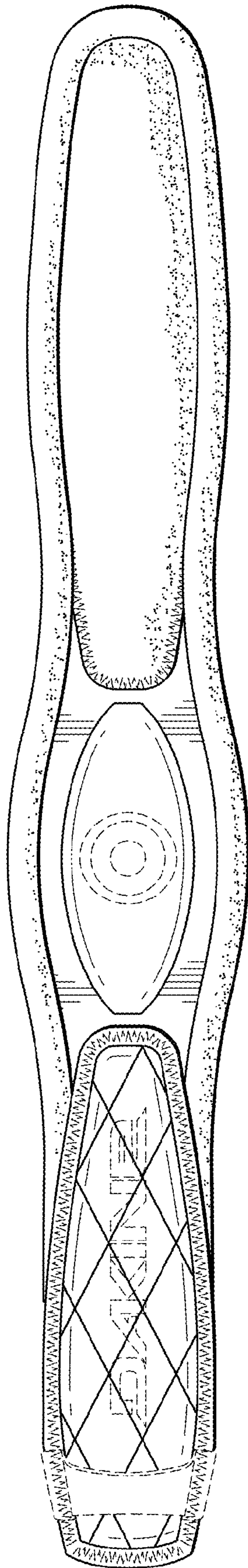

FIG. 17

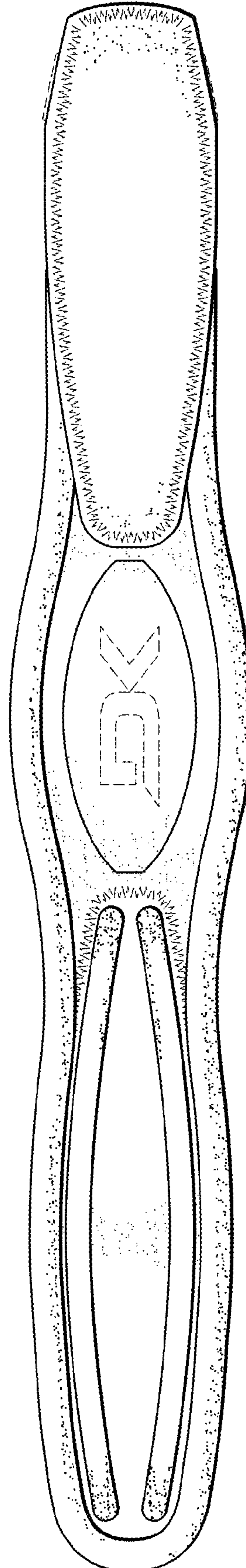

FIG. 18

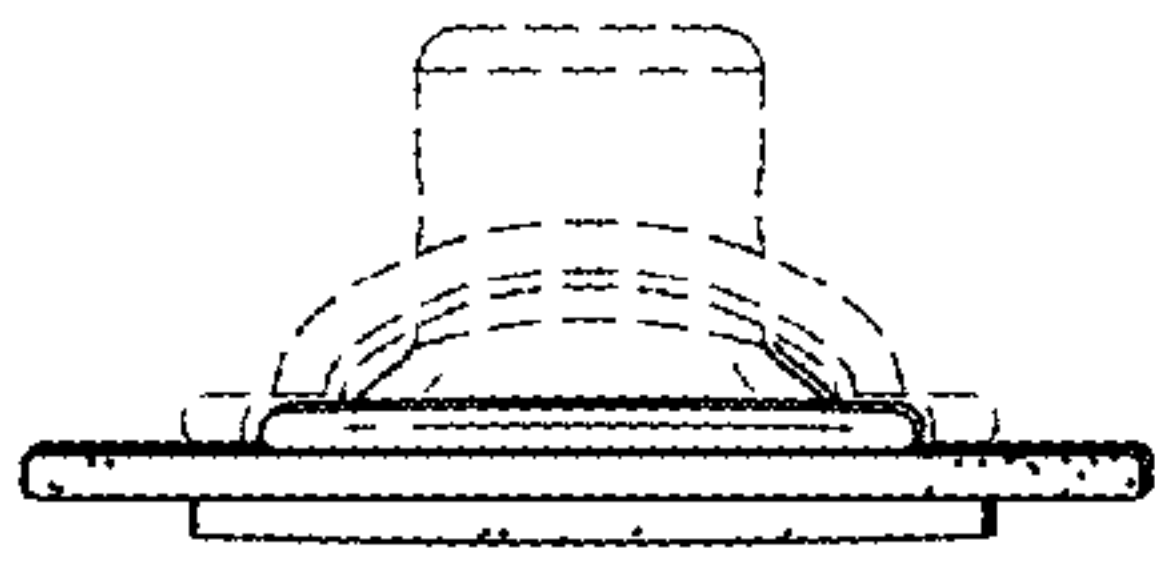

FIG. 19

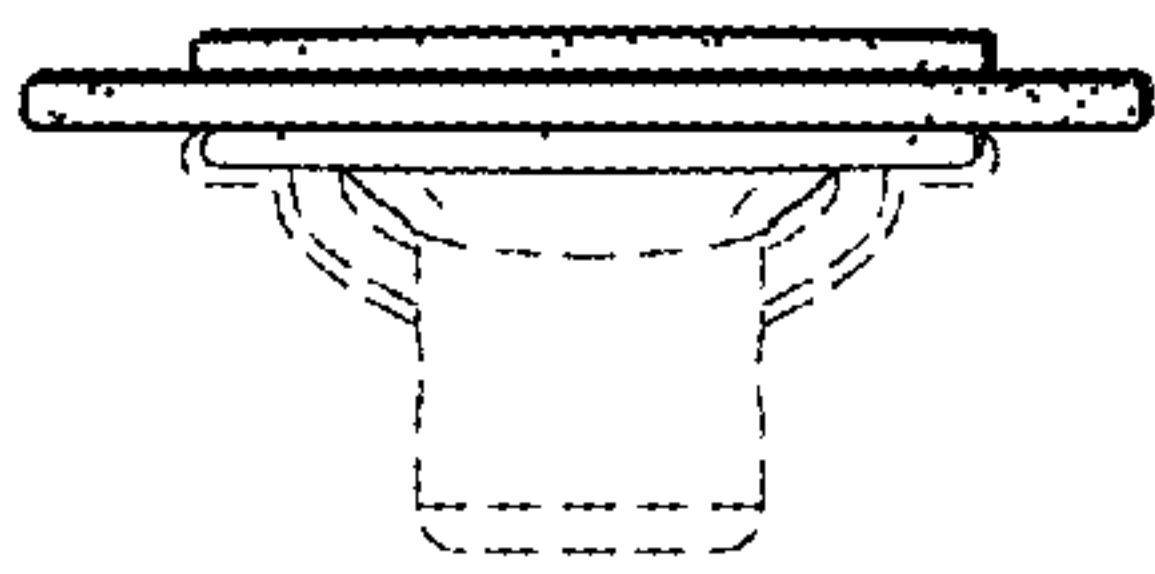

FIG. 20



FIG. 21

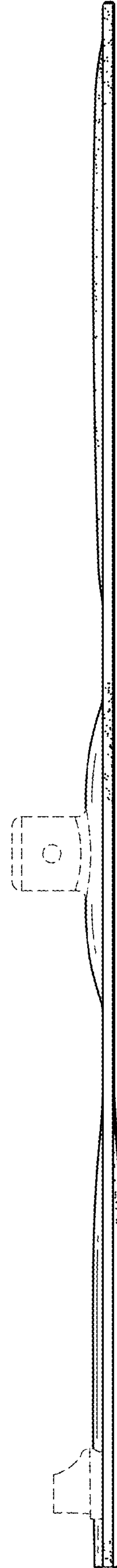

FIG. 22

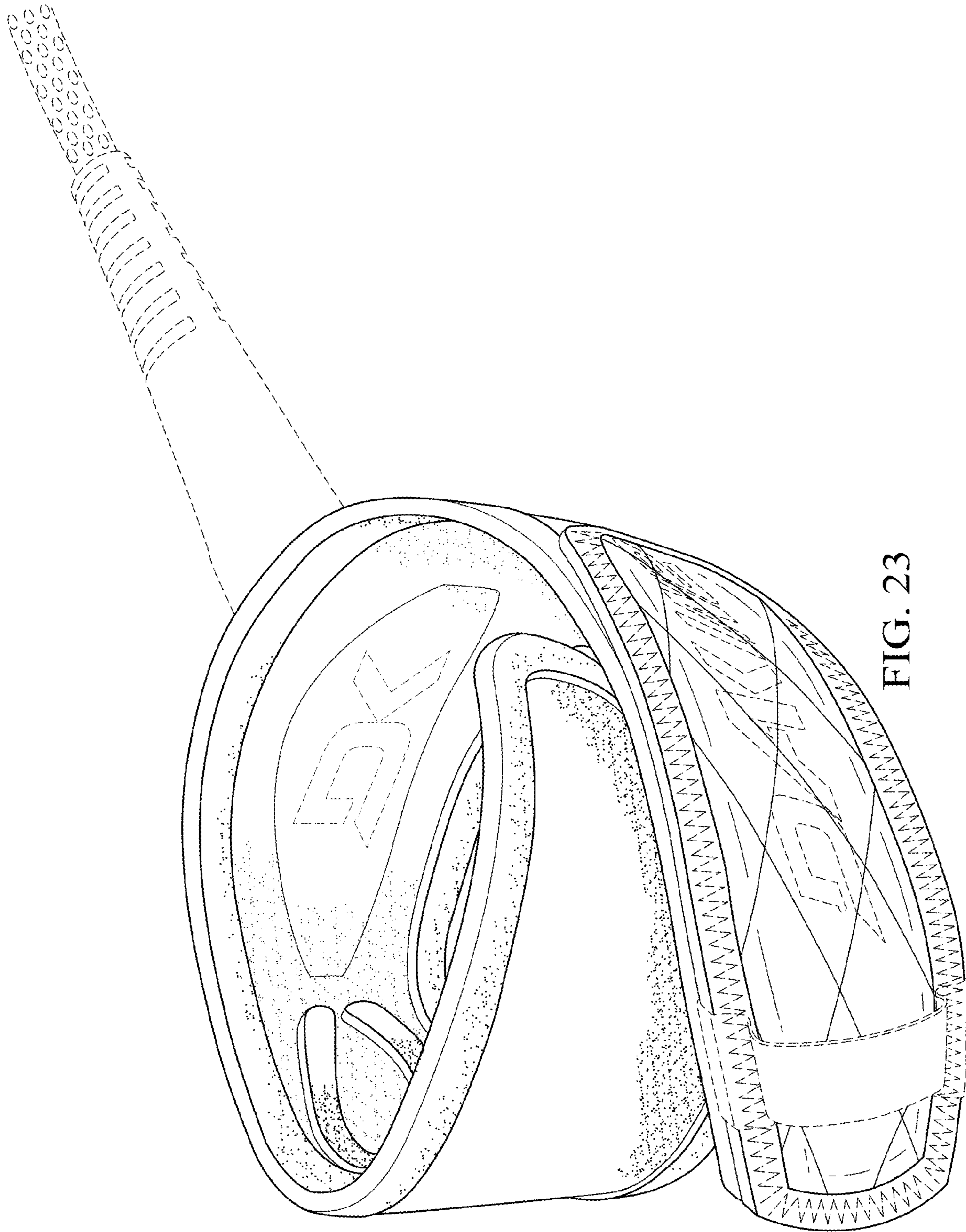

FIG. 23

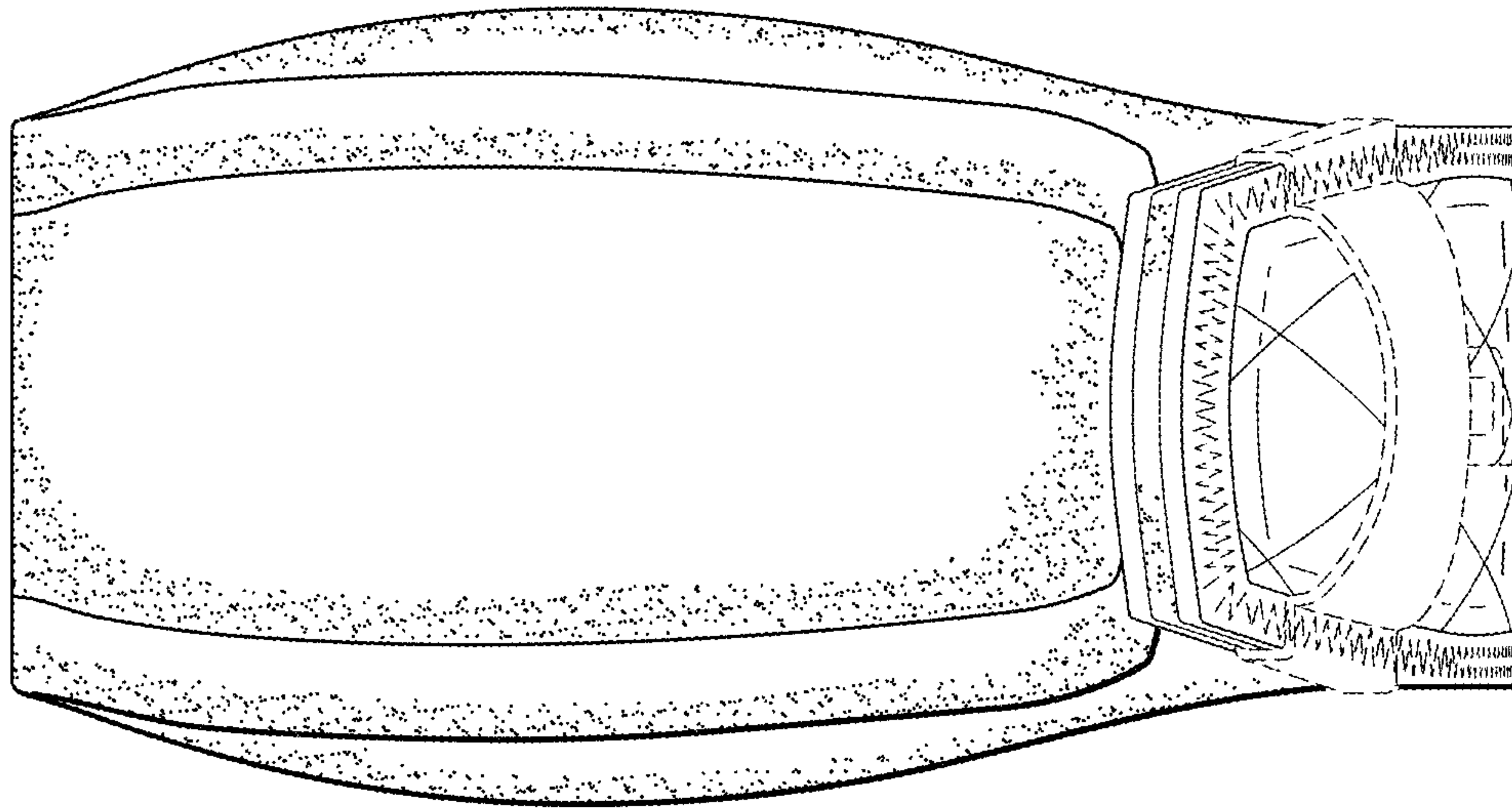

FIG. 24

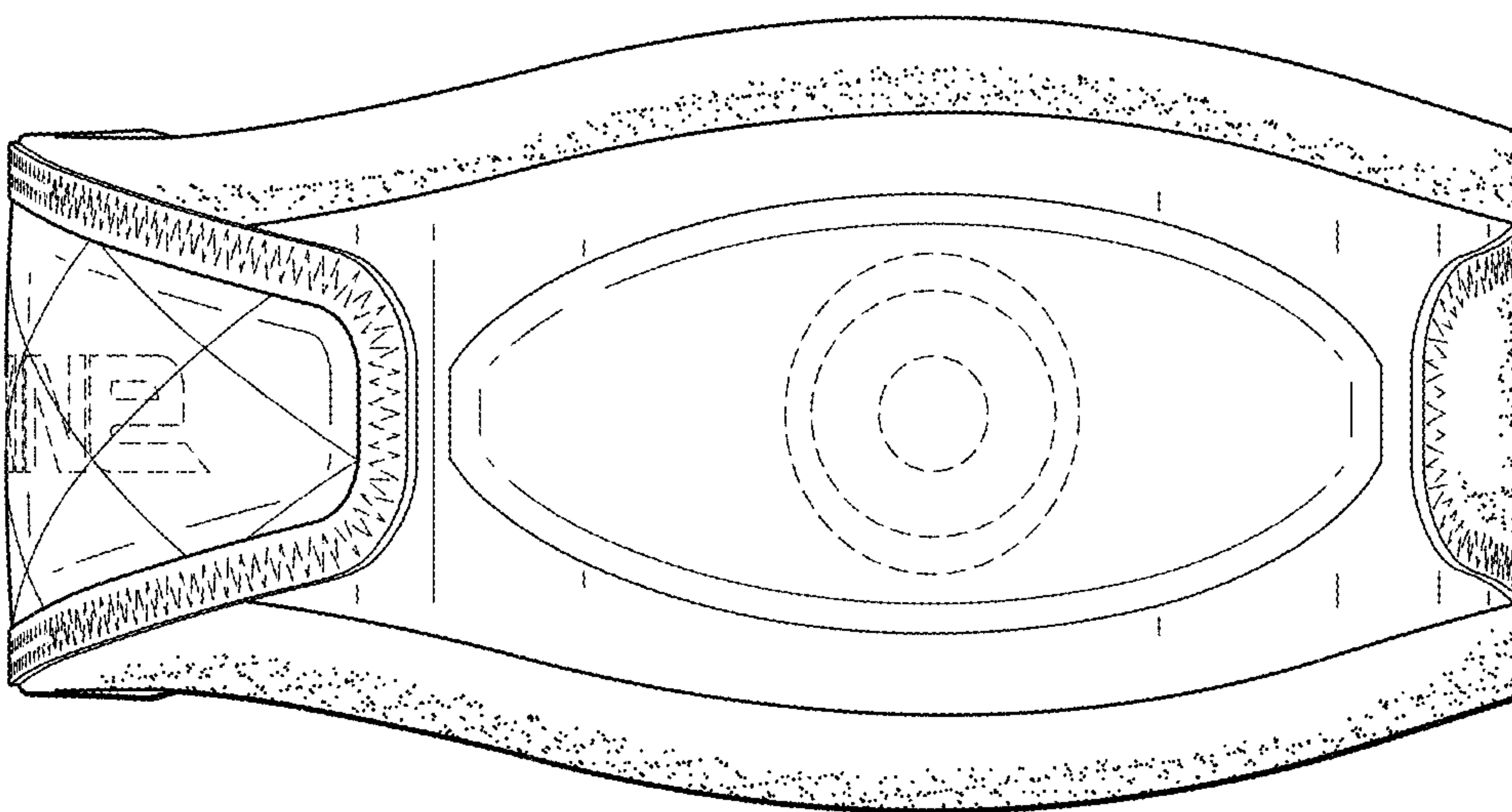

FIG. 25

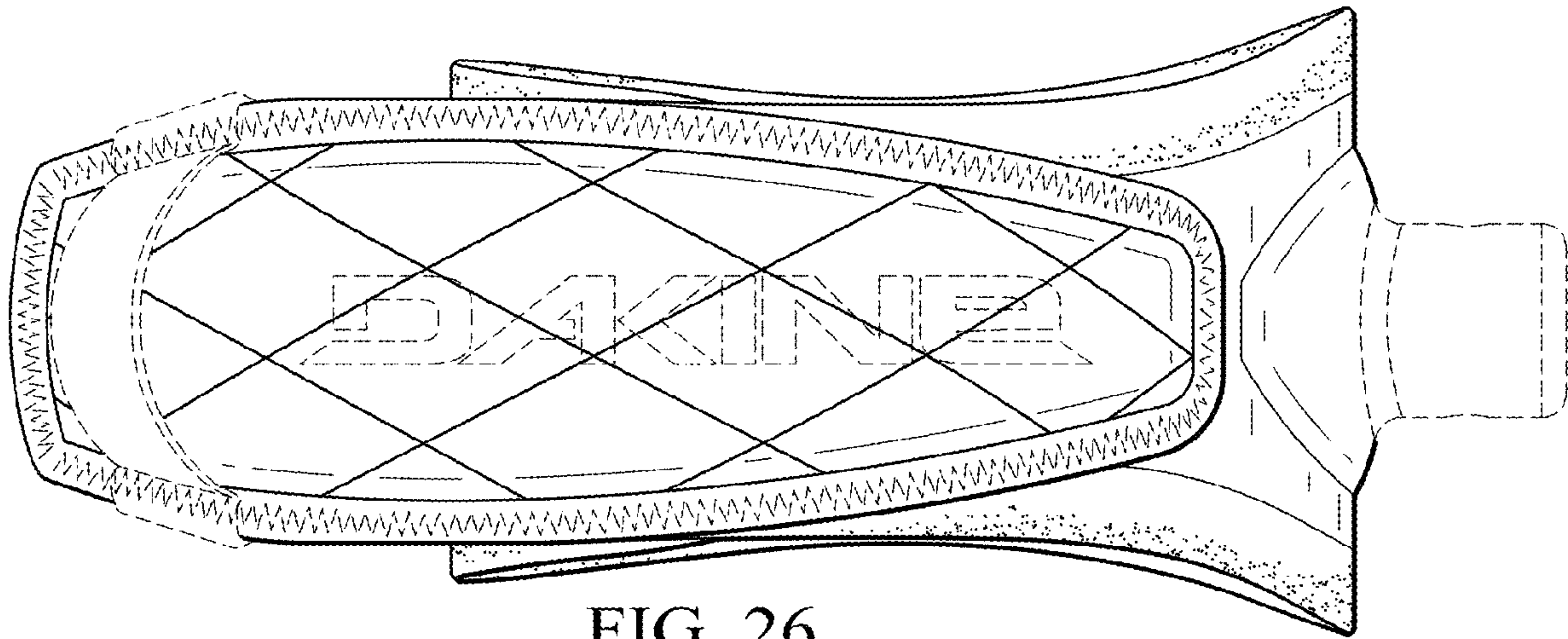

FIG. 26

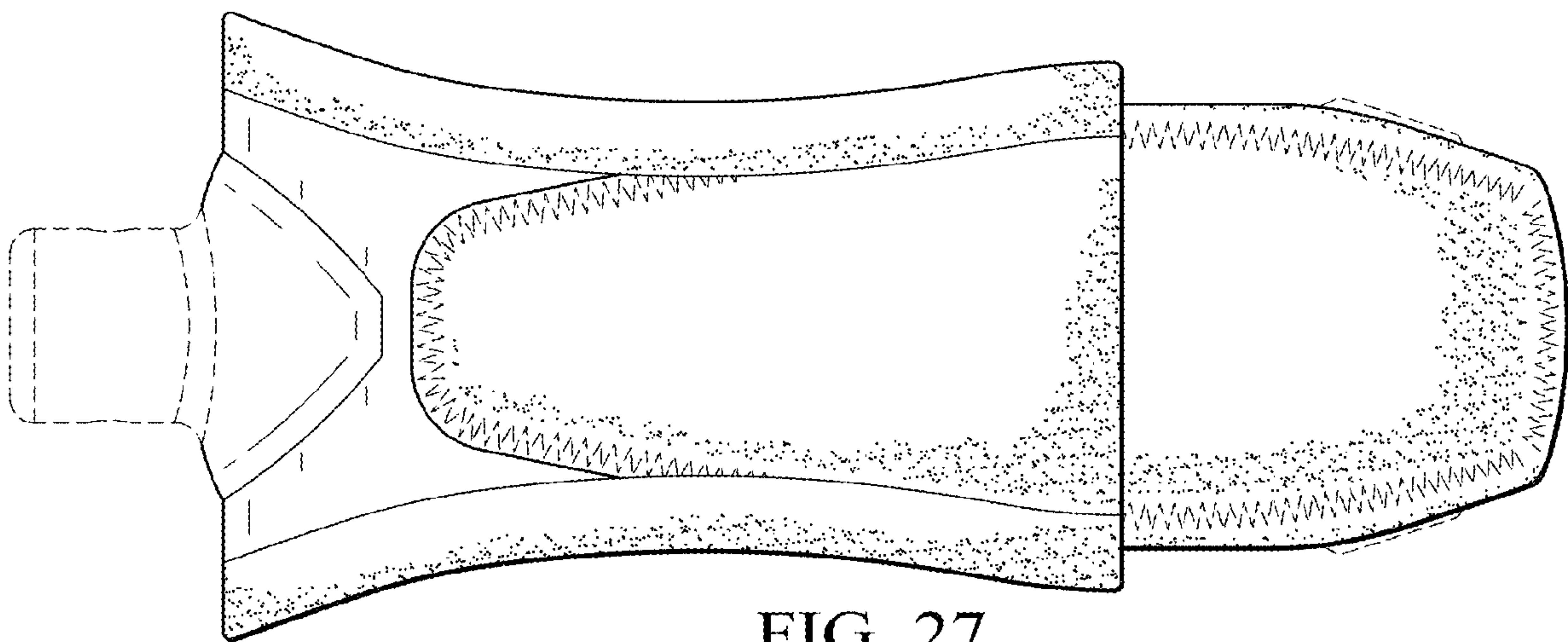

FIG. 27

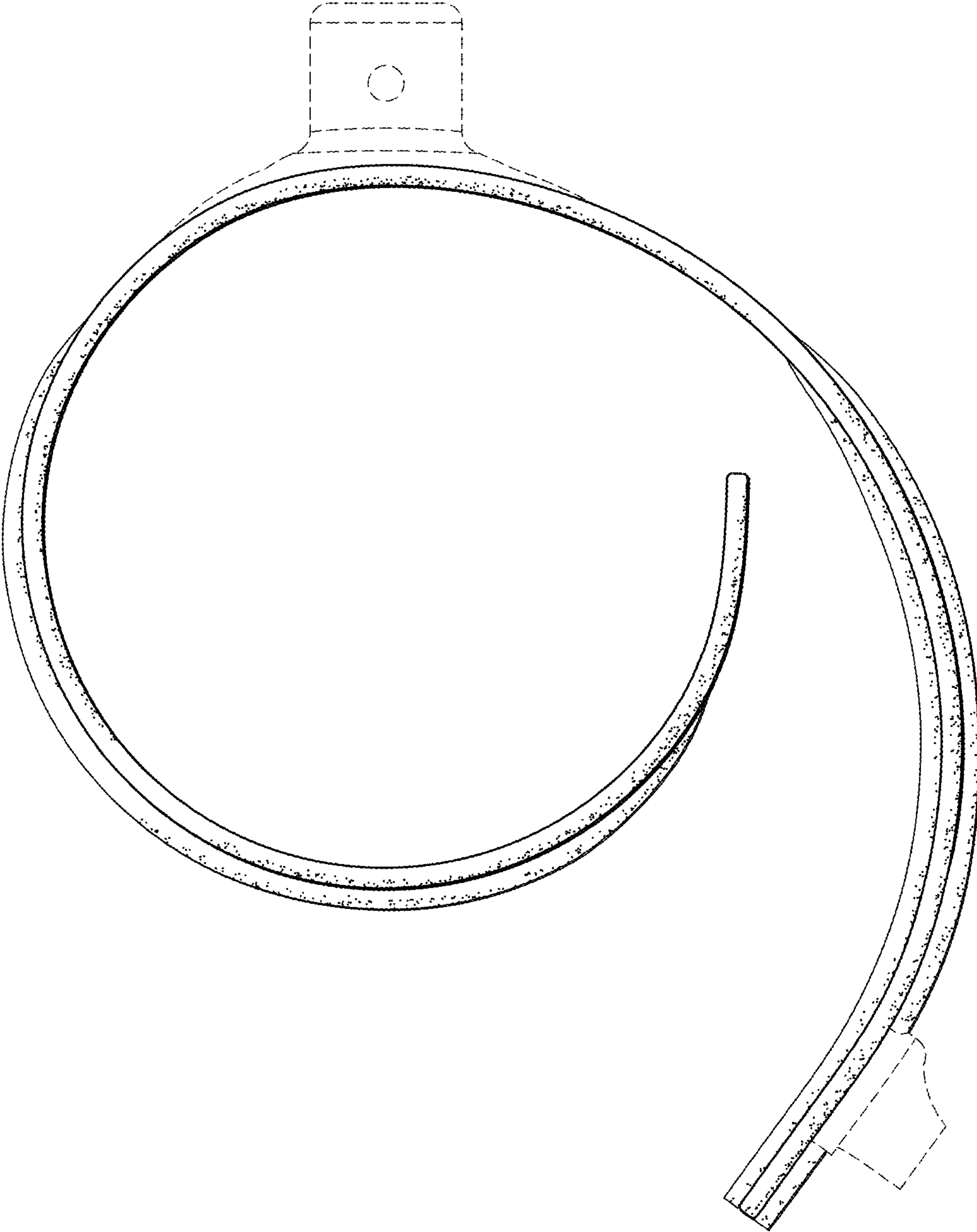

FIG. 28

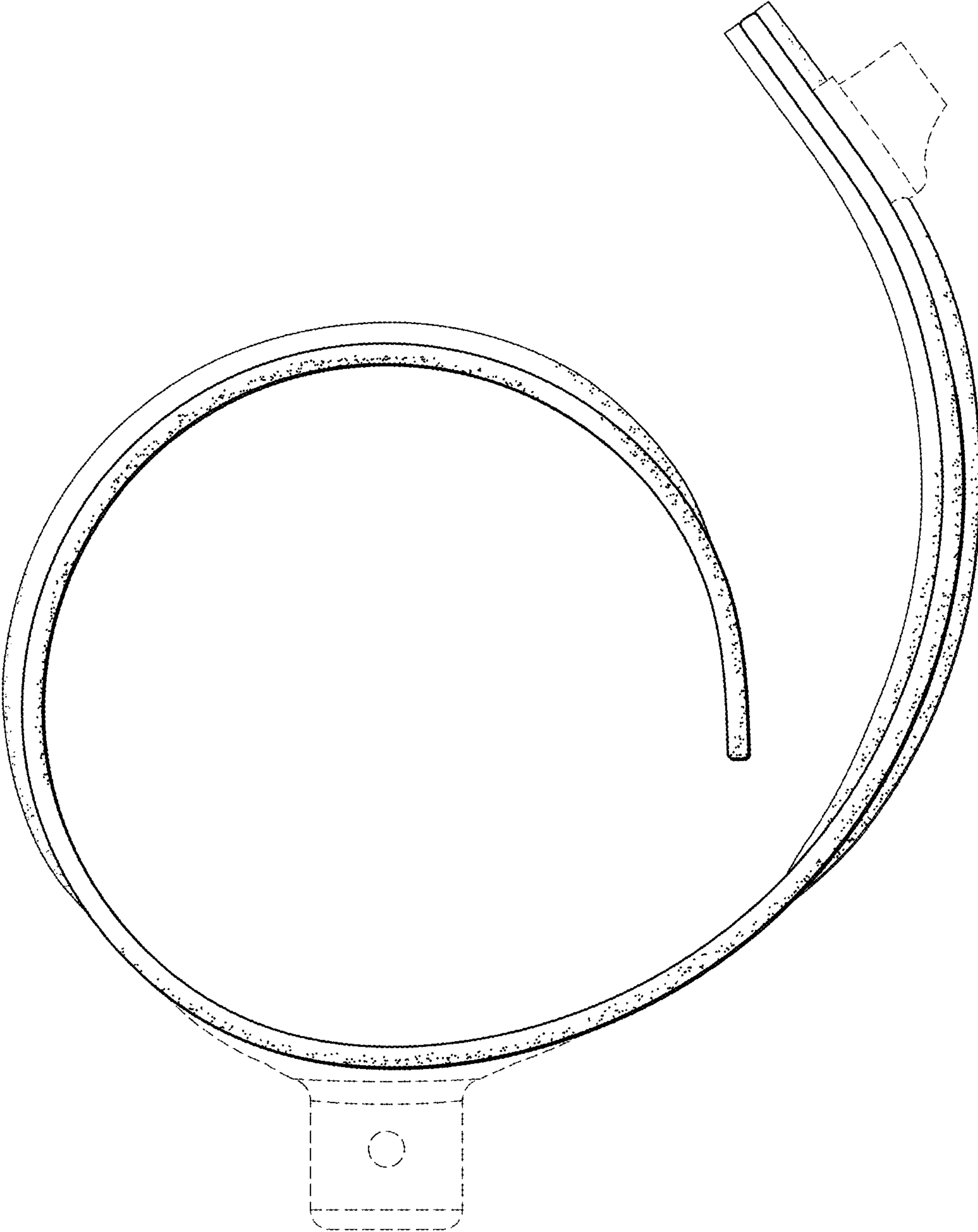

FIG. 29

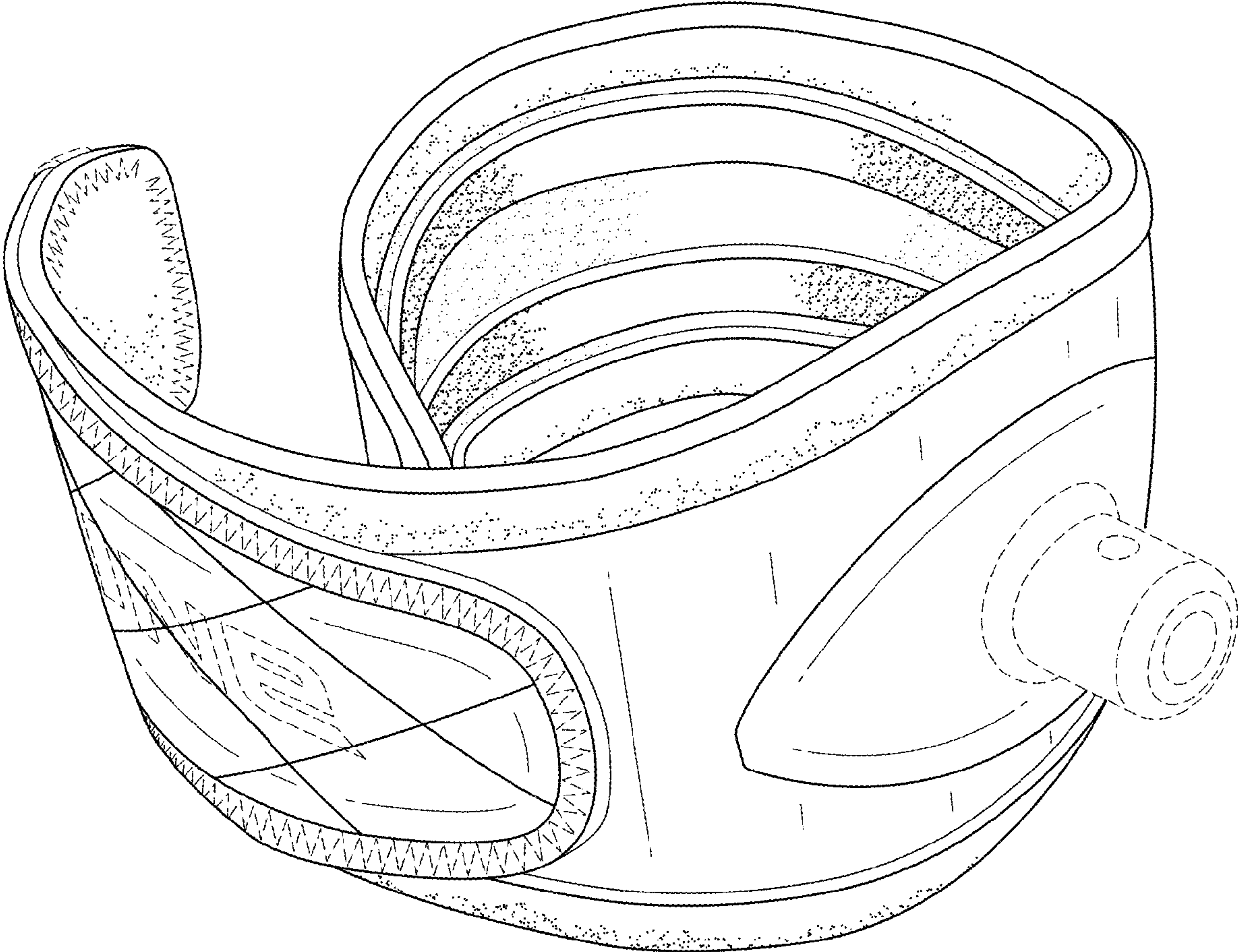

FIG. 30