



US00D921749S

(12) **United States Design Patent** (10) **Patent No.:** **US D921,749 S**  
**Reed et al.** (45) **Date of Patent:** **\*\* Jun. 8, 2021**

(54) **TRANSACTION CARD**

- (71) Applicant: **VISA INTERNATIONAL SERVICE ASSOCIATION**, San Francisco, CA (US)
- (72) Inventors: **Sonia Reed**, Danville, CA (US); **Kenneth Sippola**, San Francisco, CA (US); **Julian Schmidt**, Orinda, CA (US)
- (73) Assignee: **VISA INTERNATIONAL SERVICE ASSOCIATION**, San Francisco, CA (US)

- (\*\*) Term: **15 Years**
- (21) Appl. No.: **29/681,905**
- (22) Filed: **Feb. 28, 2019**

**Related U.S. Application Data**

- (63) Continuation of application No. 13/648,142, filed on Oct. 9, 2012, now abandoned.
- (51) **LOC (13) Cl.** ..... **19-08**
- (52) **U.S. Cl.**  
USPC ..... **D19/9**
- (58) **Field of Classification Search**  
USPC ..... D19/1-12, 20-34, 100;  
40/124.01-124.15, 672, 661, 726, 776,  
(Continued)

(56) **References Cited**

**U.S. PATENT DOCUMENTS**

- 3,836,754 A 9/1974 Toye
  - 4,593,936 A 6/1986 Opel
- (Continued)

**FOREIGN PATENT DOCUMENTS**

- AU 144339 S 10/2000
  - DE MR5001740005 1/1995
- (Continued)

**OTHER PUBLICATIONS**

Images of cards published in IndexDesign catalog, 2004, 4 pages.  
(Continued)

*Primary Examiner* — Abraham Bahta  
(74) *Attorney, Agent, or Firm* — Loeb & Loeb LLP

(57) **CLAIM**

The ornamental design for a transaction card, as shown and described.

**DESCRIPTION**

FIG. 1 is a front side perspective view of a first embodiment of a transaction card showing our new design;  
 FIG. 2 is a front side view thereof;  
 FIG. 3 is a back side view thereof;  
 FIG. 4 is a top elevational view thereof;  
 FIG. 5 is a bottom elevational view thereof;  
 FIG. 6 is a left side elevational view thereof;  
 FIG. 7 is a right side elevational view thereof;  
 FIG. 8 is a front side perspective view of a second embodiment of a transaction card showing our new design;  
 FIG. 9 is a front side view thereof;  
 FIG. 10 is a back side view thereof;  
 FIG. 11 is a top elevational view thereof;  
 FIG. 12 is a bottom elevational view thereof;  
 FIG. 13 is a left side elevational view thereof;  
 FIG. 14 is a right side elevational view thereof;  
 FIG. 15 is a front side perspective view of a third embodiment of a transaction card showing our new design;  
 FIG. 16 is a front side view thereof;  
 FIG. 17 is a back side view thereof;  
 FIG. 18 is a top elevational view thereof;  
 FIG. 19 is a bottom elevational view thereof;  
 FIG. 20 is a left side elevational view thereof;  
 FIG. 21 is a right side elevational view thereof;  
 FIG. 22 is a front side perspective view of a fourth embodiment of a transaction card showing our new design;  
 FIG. 23 is a front side view thereof;  
 FIG. 24 is a back side view thereof;  
 FIG. 25 is a top elevational view thereof;

(Continued)

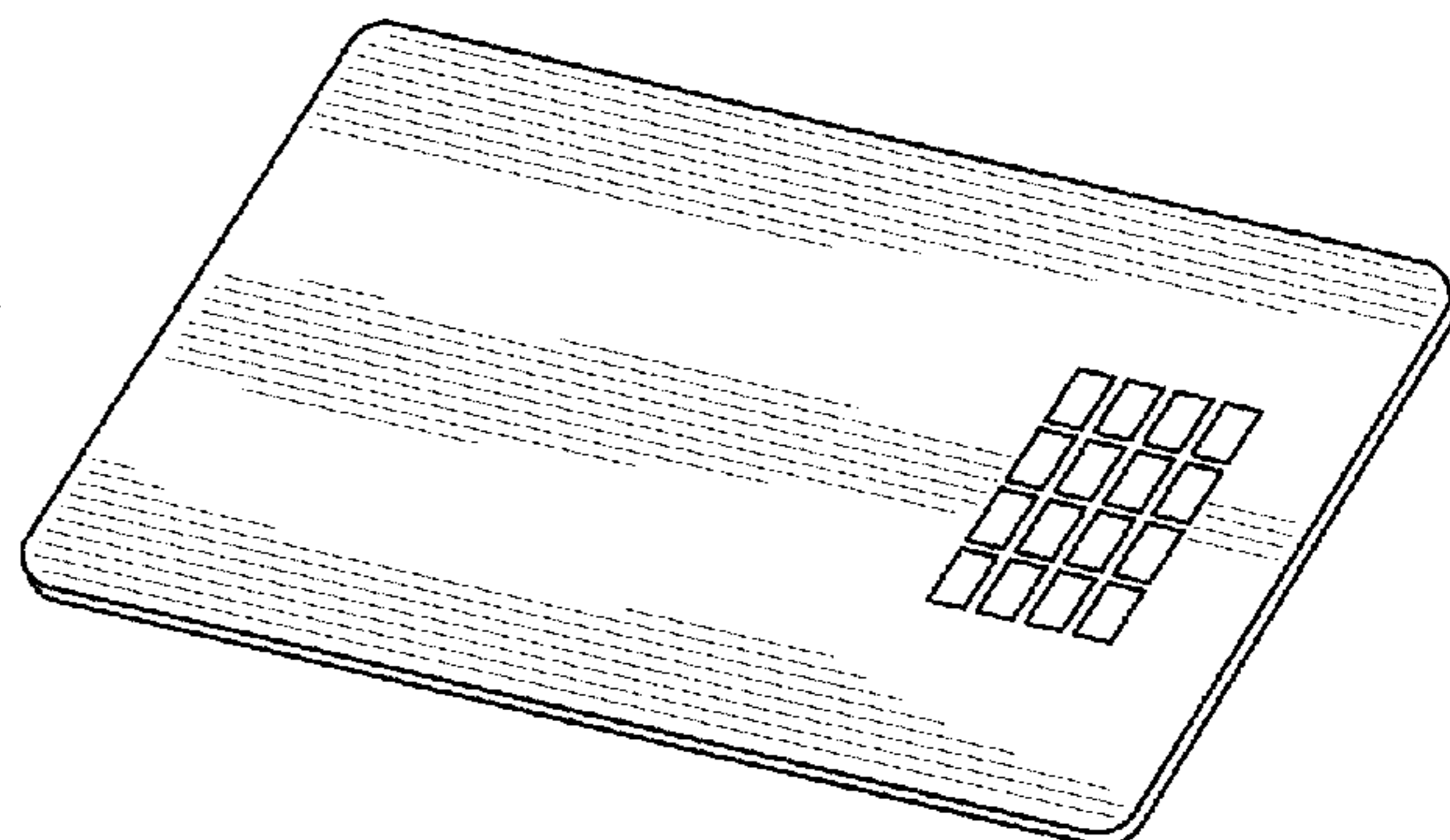
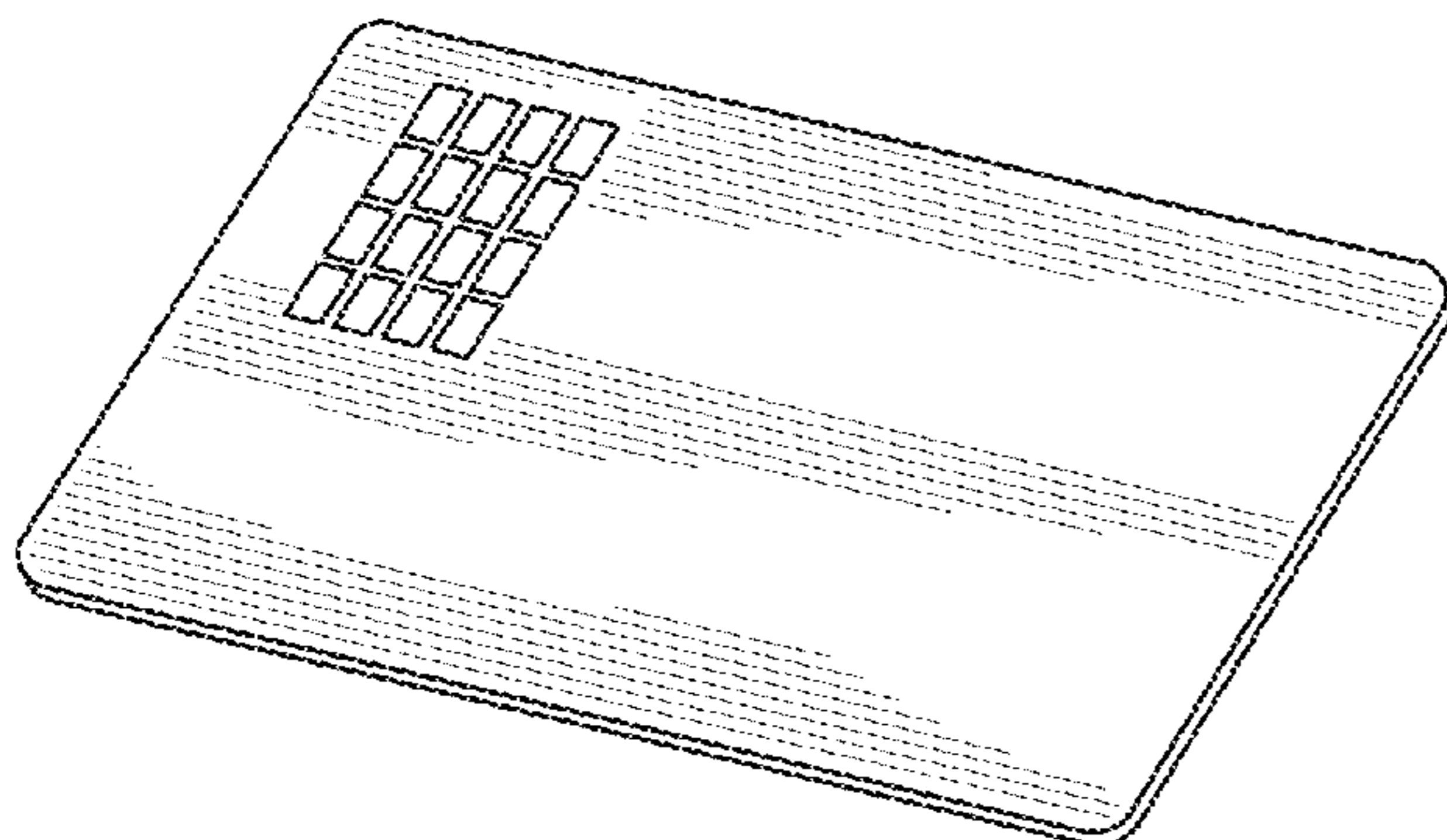





The boxes shown in FIGS. 1, 2, 8, 9, 15, 16, 22, 23, 29, 30, 36, 37, 43, 44, 50, 51, 57, 58, 64, 65, 71, 72, 78, 79, 85, 86, 92, 93, 99, 100, 106, 107, 113, 114, 120, 121, 127, 129, 134, 136, 141, 143, 148, 150, 155, 157, 162, 164, 169, 171, 176, 178, 183, 185, 190, 192, 197, 199, 204, 206, 211, 213, 218, 220, 225, 227, 232, 234, 239, 241, 246, 248, and represent positions for characters in an account identifier in the illustrated transactions cards. The characters may be numbers, letters, or symbols.

**1 Claim, 36 Drawing Sheets**

**(58) Field of Classification Search**

USPC ..... 40/617; 283/72, 74-75, 103, 105-117, 283/82, 70, 94, 81; 206/449; D21/385; D20/10, 22, 27, 40, 42, 11; D14/435-437; 235/380, 382, 487, 493, 235/488; D6/613, 583; 360/2; 702/158, 702/86, 97, 163, 166, 170  
 CPC .... B42D 15/00; B42D 15/022; B42D 15/027; B42D 15/042; B42D 15/045; B42D 25/00; B42D 25/20; B42D 25/30; B42D 25/23; B42D 25/26; B42D 25/29; B42D 25/285; B42D 2033/00; B42D 2033/02; B42D 2033/04; B42D 2033/08; B42D 2033/10; B42D 2033/18; B42D 2033/20; B42D 2033/22; B42D 2033/28; G09F 3/02; G09F 2003/0201

See application file for complete search history.

**(56) References Cited**

**U.S. PATENT DOCUMENTS**

5,259,649 A 11/1993 Shomron  
 5,712,627 A 1/1998 Watts  
 5,844,230 A 12/1998 Lalonde  
 6,050,605 A 4/2000 Mikelionis  
 D449,336 S 10/2001 Lasch  
 D509,512 S 9/2005 Mulloy  
 D515,134 S 2/2006 Stewart, III  
 7,219,835 B2 5/2007 Graves  
 D578,159 S 10/2008 Hachey  
 7,793,834 B2 9/2010 Hachey  
 7,793,837 B1 9/2010 Faith  
 7,938,318 B2 5/2011 Fein  
 8,413,894 B2 4/2013 Bona  
 8,490,866 B1 7/2013 Aibazov  
 8,628,017 B2 1/2014 Bona  
 D709,128 S 7/2014 Reed  
 D710,440 S \* 8/2014 Reed ..... D19/10  
 D710,938 S 8/2014 Reed  
 8,876,011 B2 11/2014 Olson  
 D724,660 S \* 3/2015 Sippola ..... D19/10  
 D725,187 S \* 3/2015 Sippola ..... D19/10  
 D725,188 S \* 3/2015 Sippola ..... D19/10  
 D725,189 S \* 3/2015 Sippola ..... D19/10  
 D725,701 S \* 3/2015 Sippola ..... D19/10  
 D742,963 S \* 11/2015 Sippola ..... D19/10  
 9,245,220 B2 1/2016 Olson  
 D765,177 S 8/2016 Hewitt  
 2008/0308641 A1 12/2008 Finn  
 2009/0037326 A1 2/2009 Chitti

2010/0065626 A1 3/2010 Hammad  
 2010/0121692 A1 5/2010 Top  
 2010/0243741 A1 9/2010 Eng  
 2010/0287085 A1 11/2010 Joubert  
 2011/0101109 A1 5/2011 Bona  
 2011/0178924 A1 7/2011 Briscoe  
 2011/0284626 A1 11/2011 Faith  
 2012/0223146 A1 9/2012 Reed  
 2013/0191281 A1 7/2013 Bona

**FOREIGN PATENT DOCUMENTS**

DE 400044620001 4/2000  
 DE 498096030002 5/2019  
 EM 0000882570005 A1 10/2003  
 EM 0002410390001 A1 8/2004  
 EM 0006503120005 A1 4/2007  
 EM 0009072170002 A1 5/2008  
 EM 0009098900006 A1 5/2008  
 EM 0015885670019 A1 7/2009  
 EM 0011291750002 A1 8/2009  
 EM 0015968830005 A1 8/2009  
 EM 0016114840001 A1 9/2009  
 EM 0016135060001 A1 5/2010  
 EM 0012176810002 A1 9/2010  
 EM 0011576630011 A1 5/2011  
 EM 0011576630014 A1 5/2011  
 EM 0011576630022 A1 5/2011  
 FR 905017001 8/1990  
 FR 905017006 8/1990  
 FR 933282001 12/1993  
 FR 970662001 2/1997  
 FR 991017001 2/1999  
 FR 001327001 3/2000  
 FR 001327002 3/2000  
 FR 001327003 3/2000  
 FR 010001016 1/2001  
 FR 016198001 10/2001  
 FR 016198002 10/2001  
 FR 016198004 10/2001  
 FR 016198005 10/2001  
 FR 016198003 1/2002  
 FR 055375002 11/2005  
 GB 2090880 7/2000  
 GB 3019966 1/2005  
 JP 1073065 6/2000  
 JP 1395431 8/2010  
 KR 1020020023396 A 3/2002  
 WO DM070255 11/2008  
 WO 2010096625 8/2010  
 WO 2010114499 A2 10/2010

**OTHER PUBLICATIONS**

International Search Report and Written Opinion dated Oct. 9, 2012 in PCT Application No. PCT/US2012/059377, 10 pages.  
 John Mayleben, New look for credit cards more than a fancy facelift, Michigan Retailers Association, Feb. 11, 2011.  
 Office Action dated Oct. 23, 2012 in related Russian Application No. 2012500767, 26 pages.  
 Office Action dated Oct. 23, 2012 in related Russian Application No. 2012501914, 25 pages.  
 Office Action dated Oct. 8, 2012 in Russian Application No. 2012500768, 37 pages.  
 U.S. Appl. No. 61/317,677, filed Mar. 25, 2010, entitled, "Portable Device Including Loyalty Region," 17 pages.  
 Office Action dated Feb. 1, 2021 for U.S. Appl. No. 29/681,904 (pp. 1-6).

\* cited by examiner

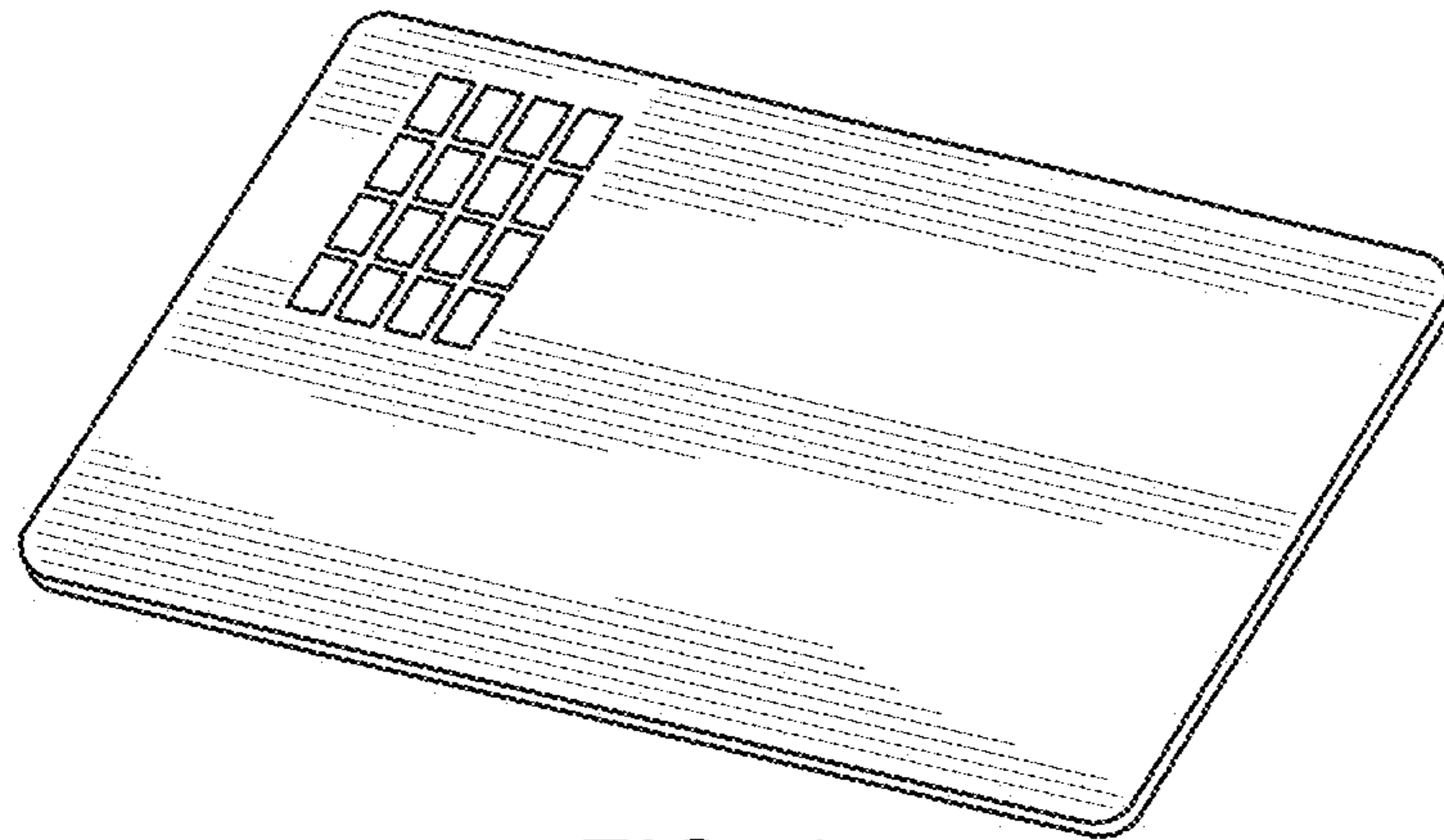

FIG. 1

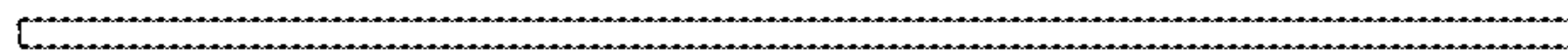

FIG. 4

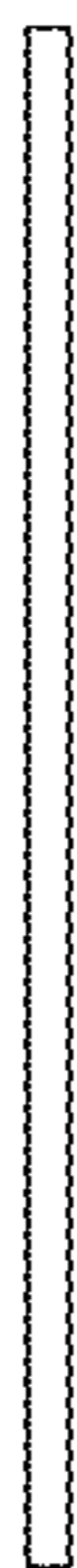

FIG. 6

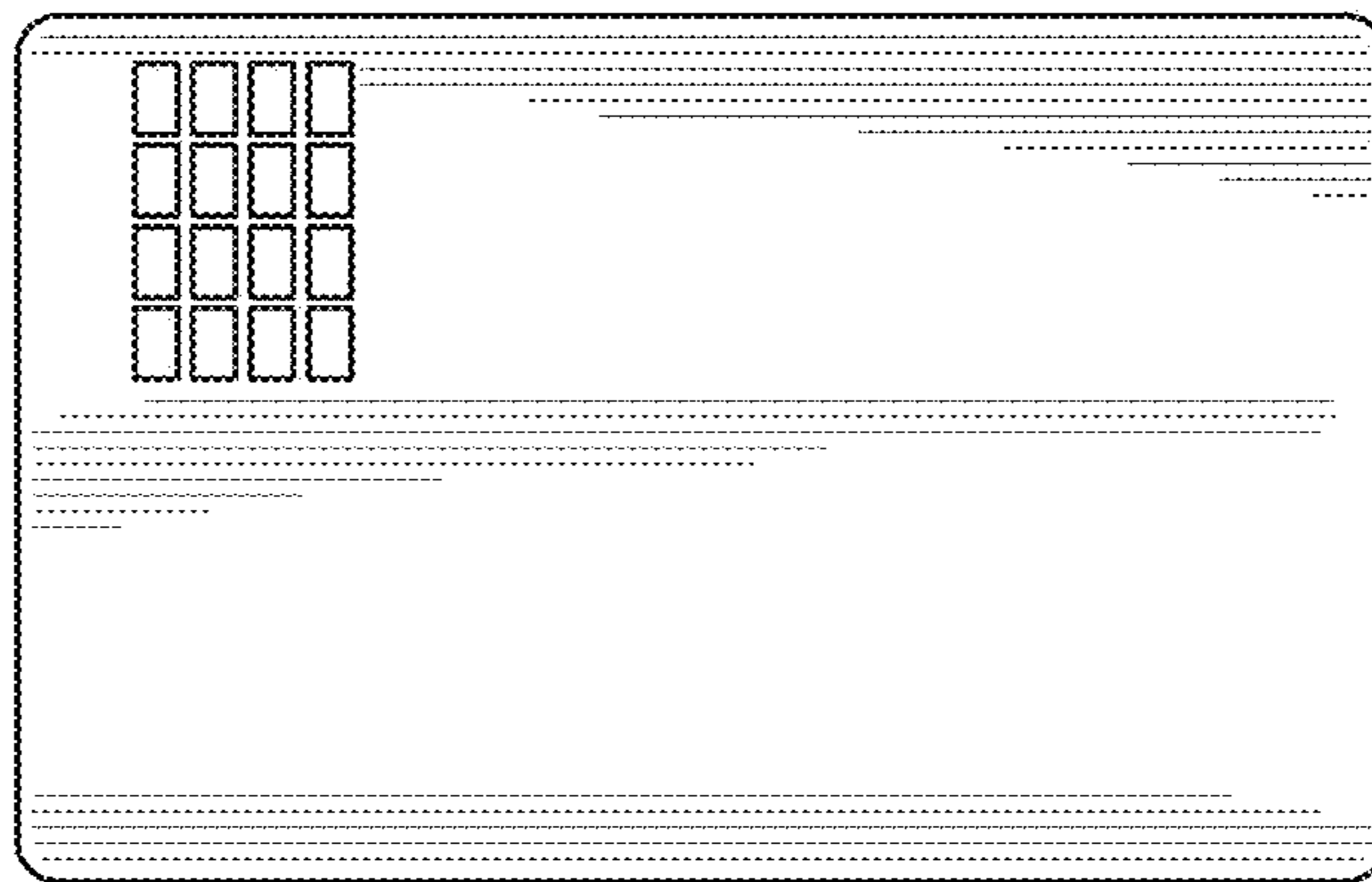

FIG. 2

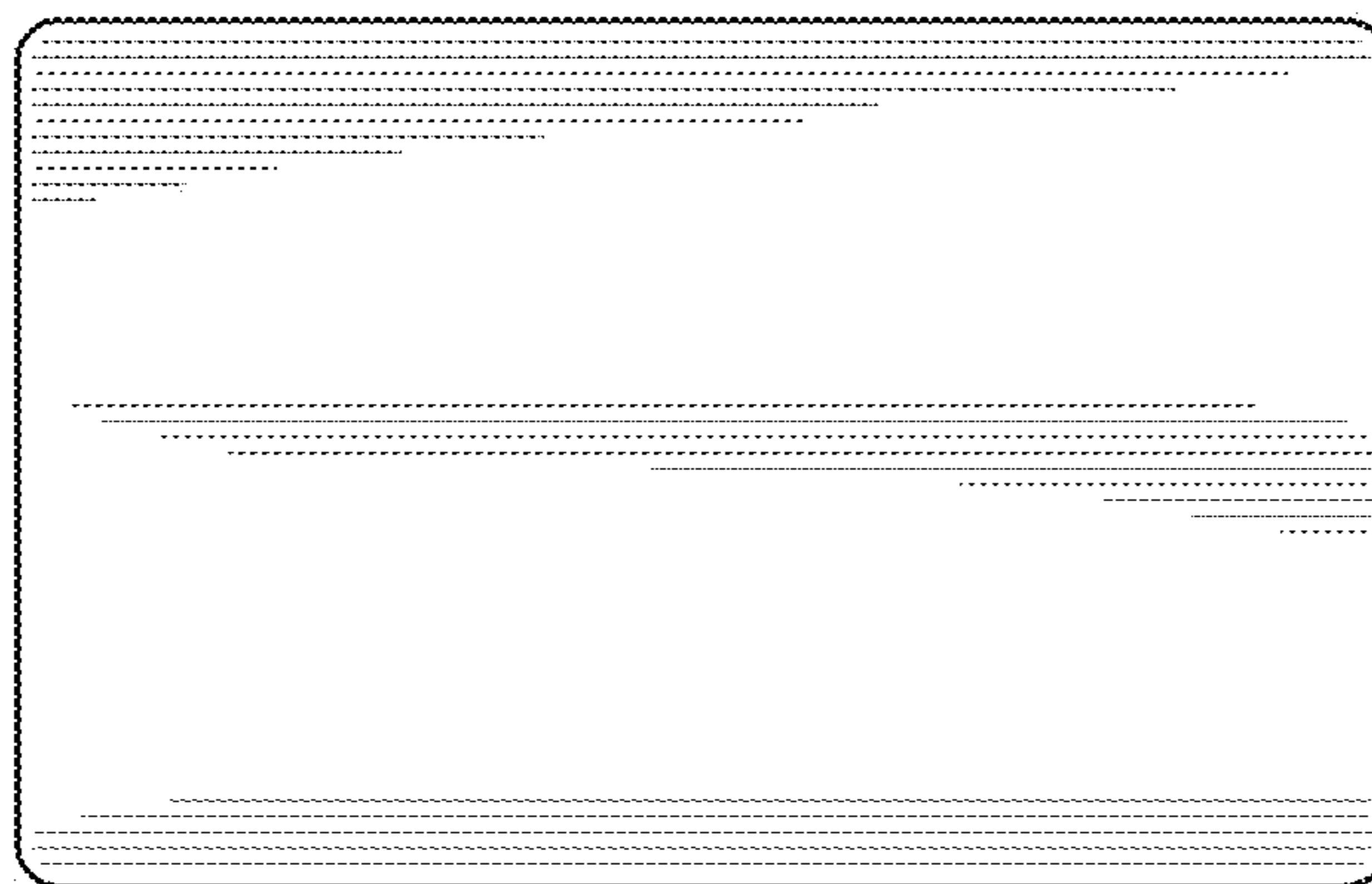

FIG. 3

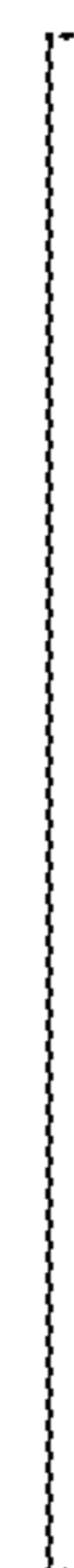

FIG. 7

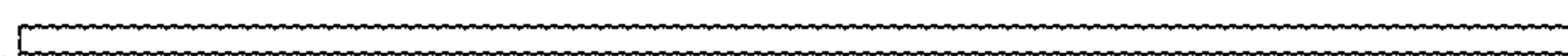

FIG. 5

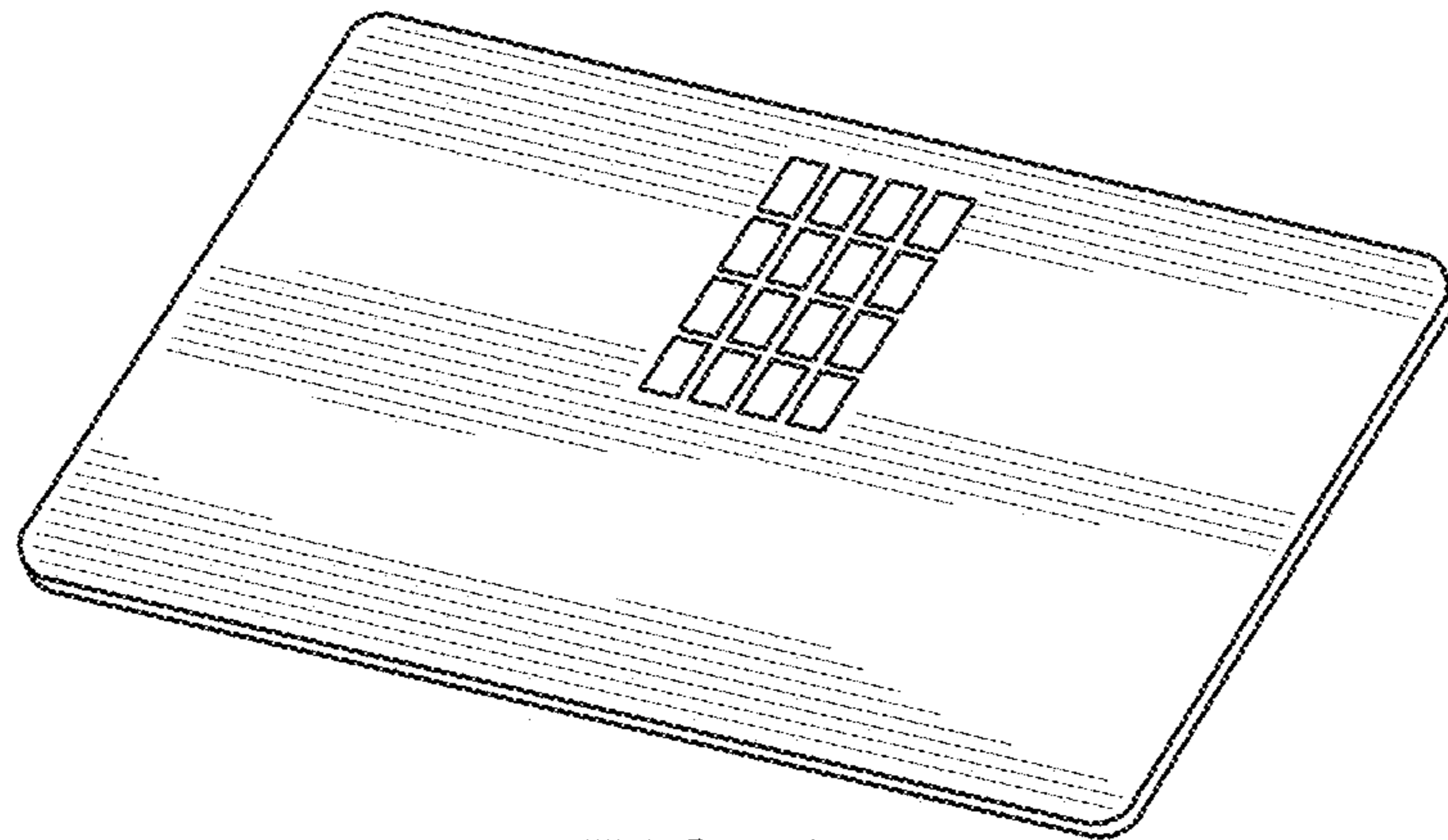

FIG. 8

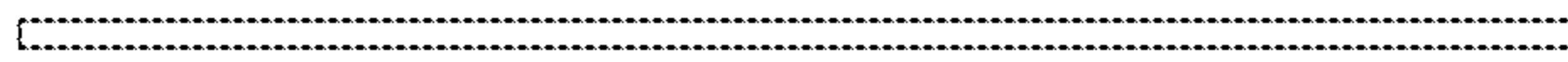

FIG. 11



FIG. 13

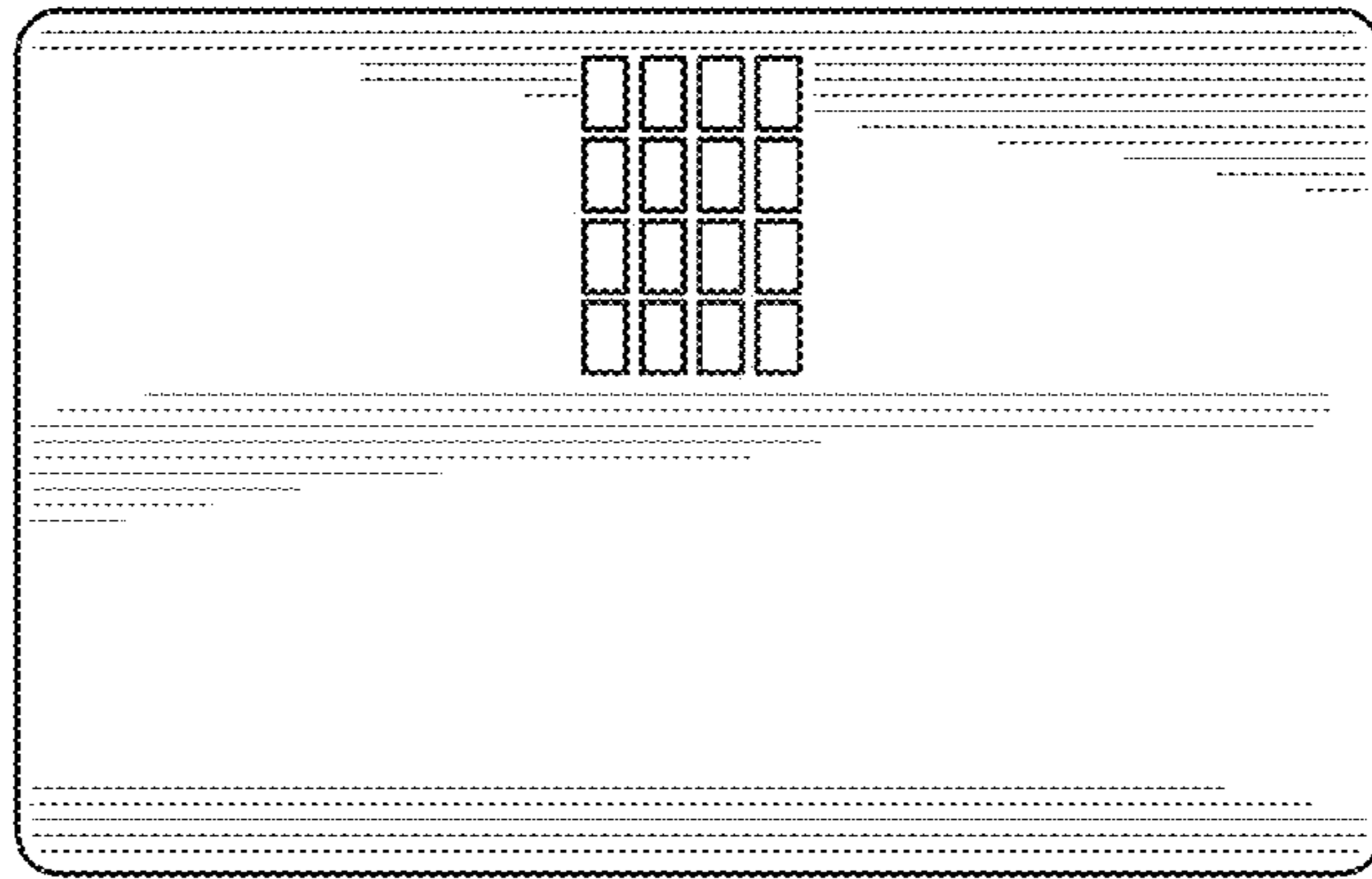

FIG. 9

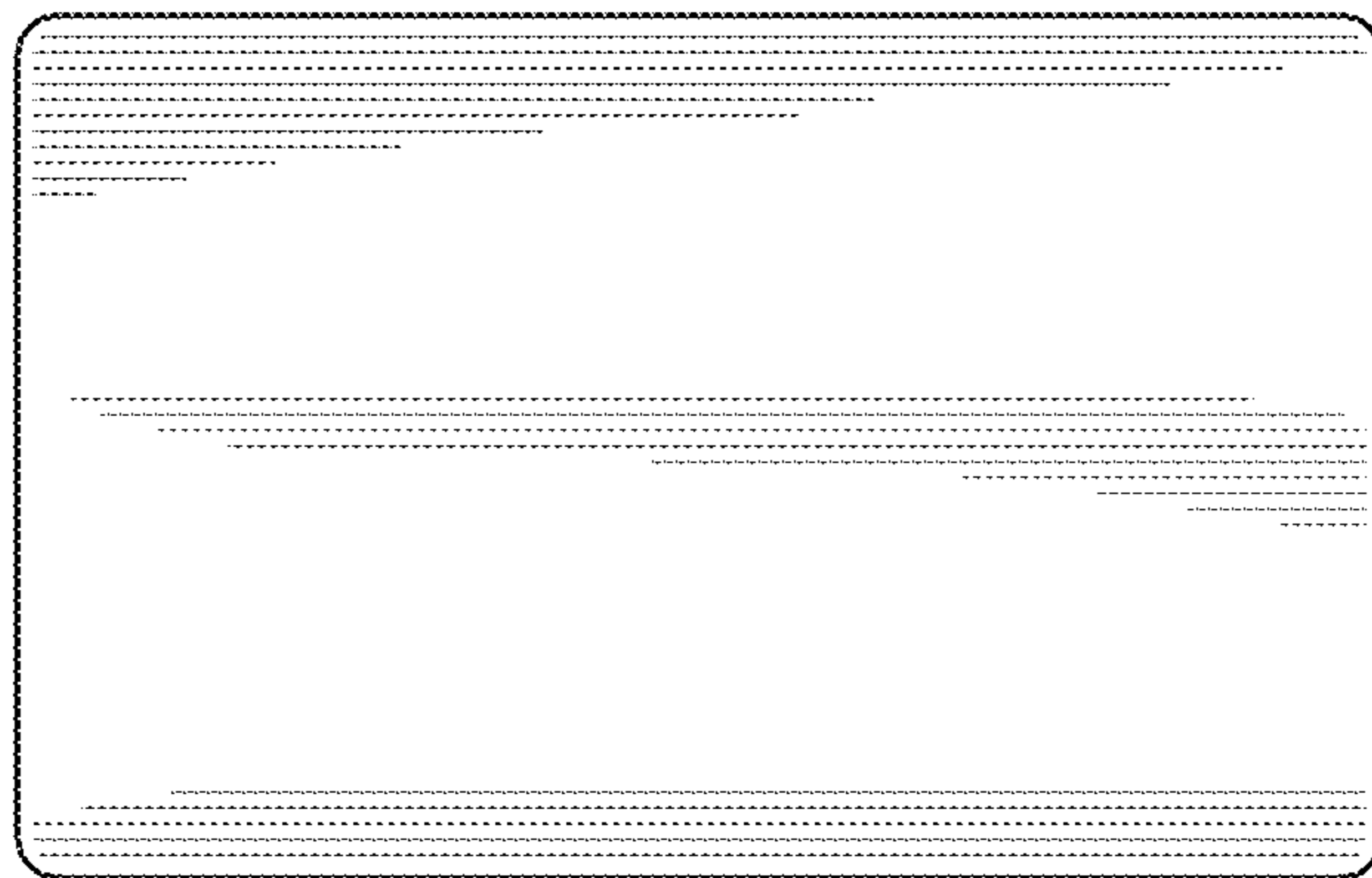

FIG. 10



FIG. 14

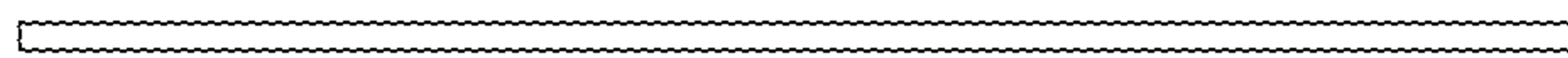

FIG. 12

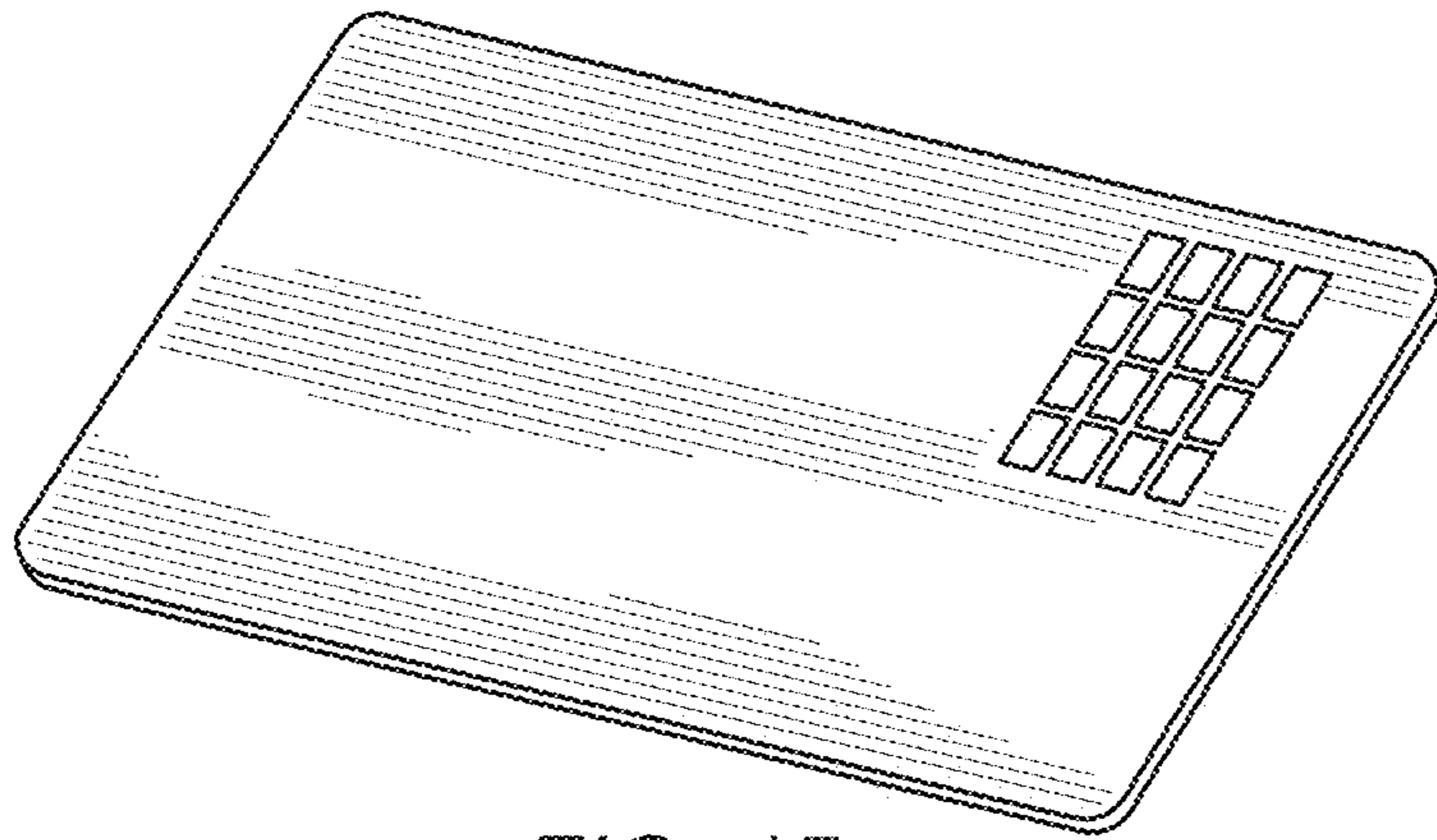

FIG. 15

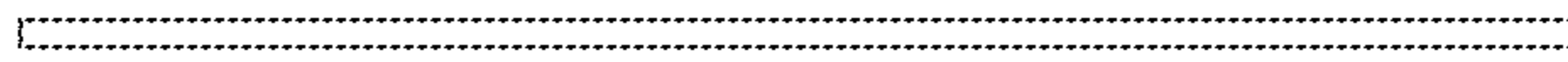

FIG. 18

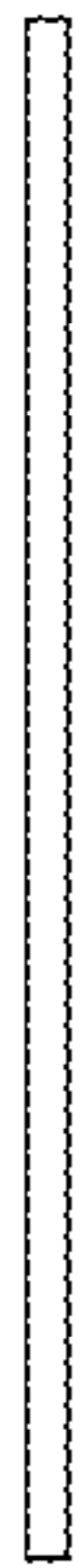

FIG. 20

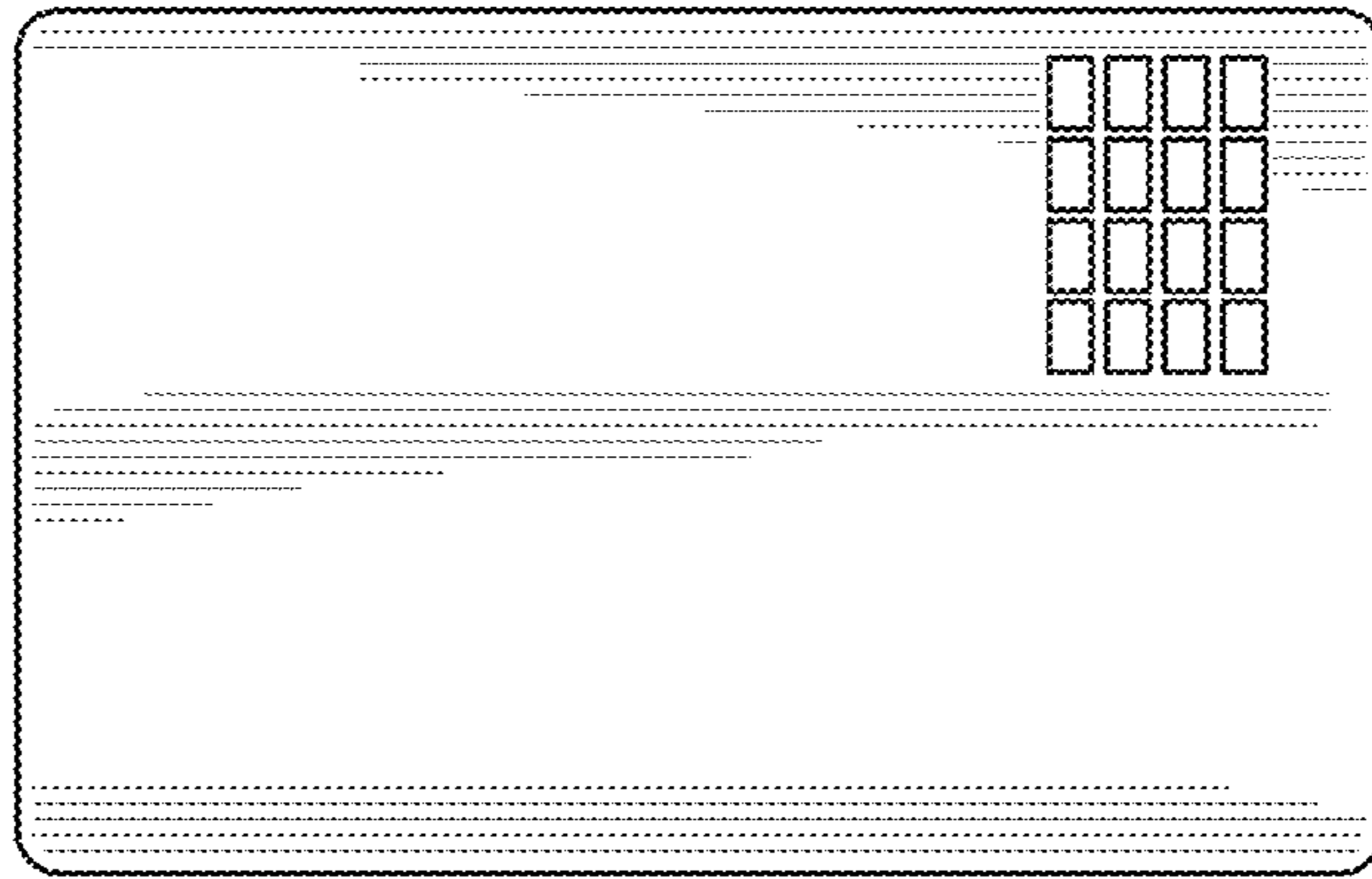

FIG. 16



FIG. 17

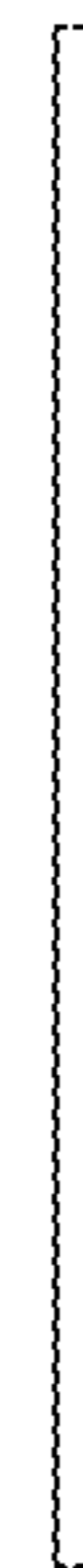

FIG. 21

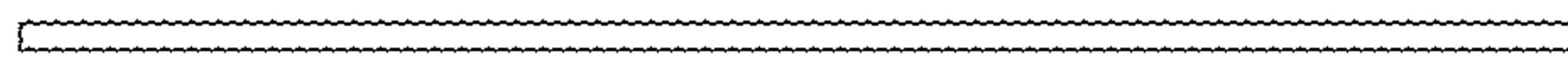

FIG. 19

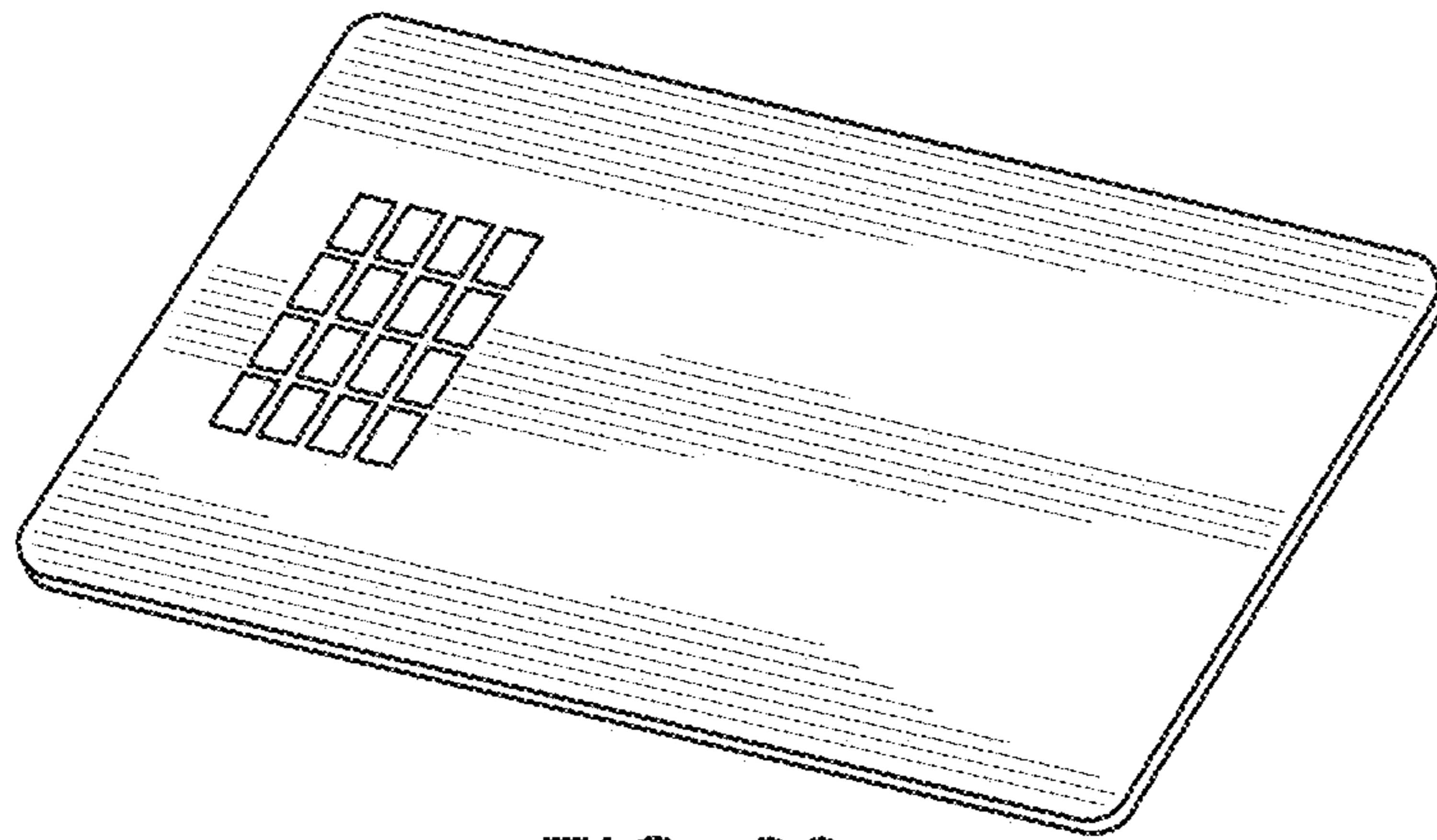

FIG. 22

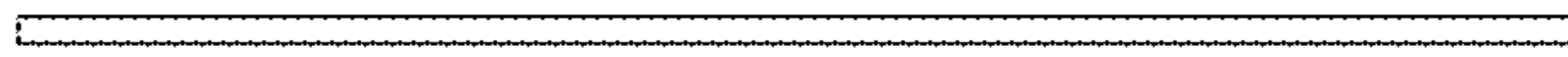

FIG. 25

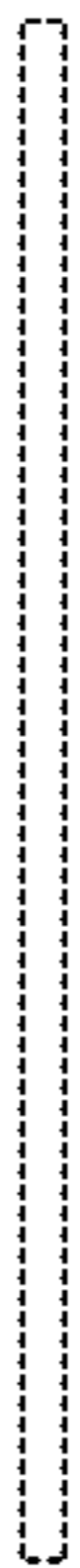

FIG. 27

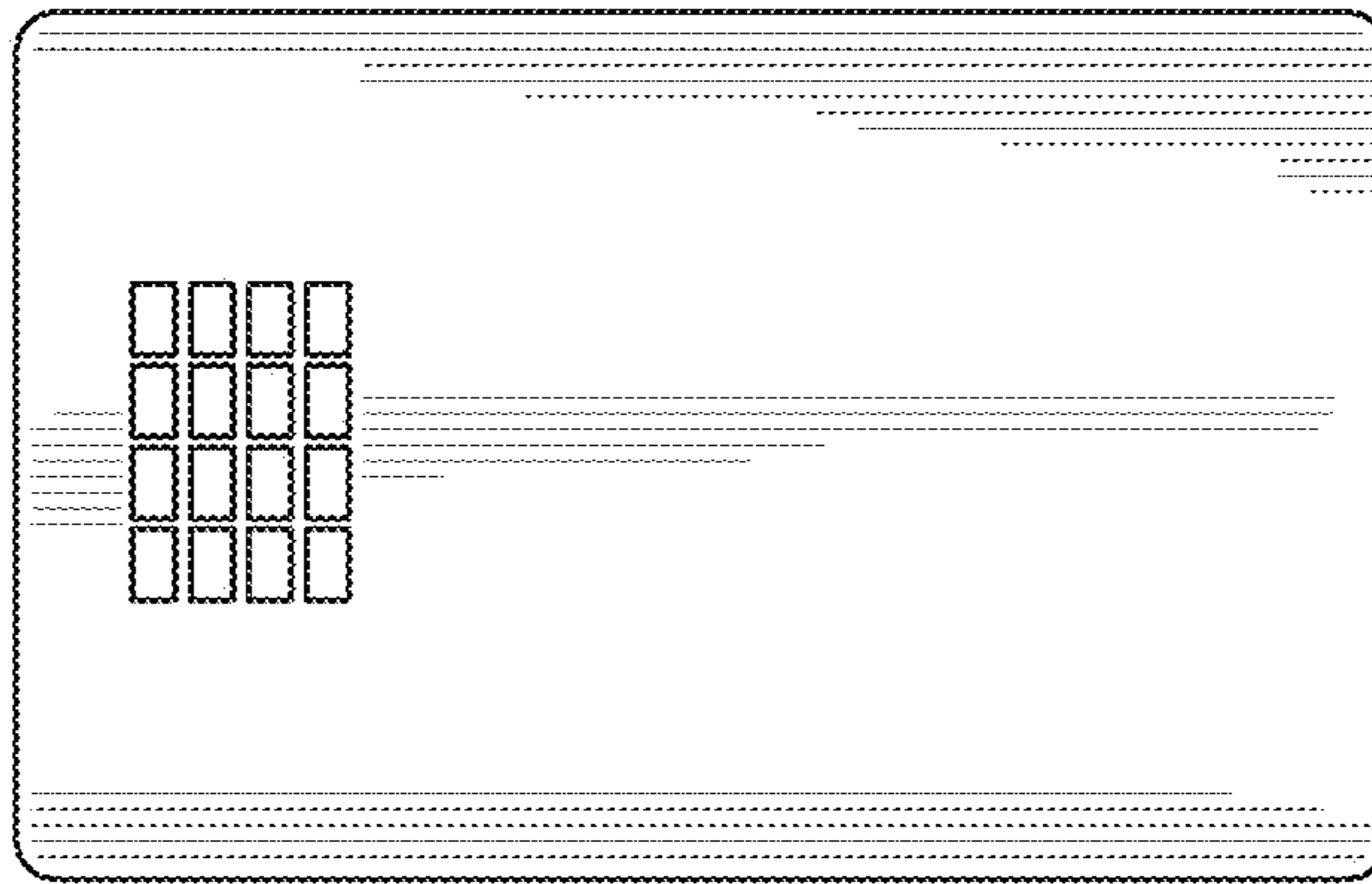

FIG. 23

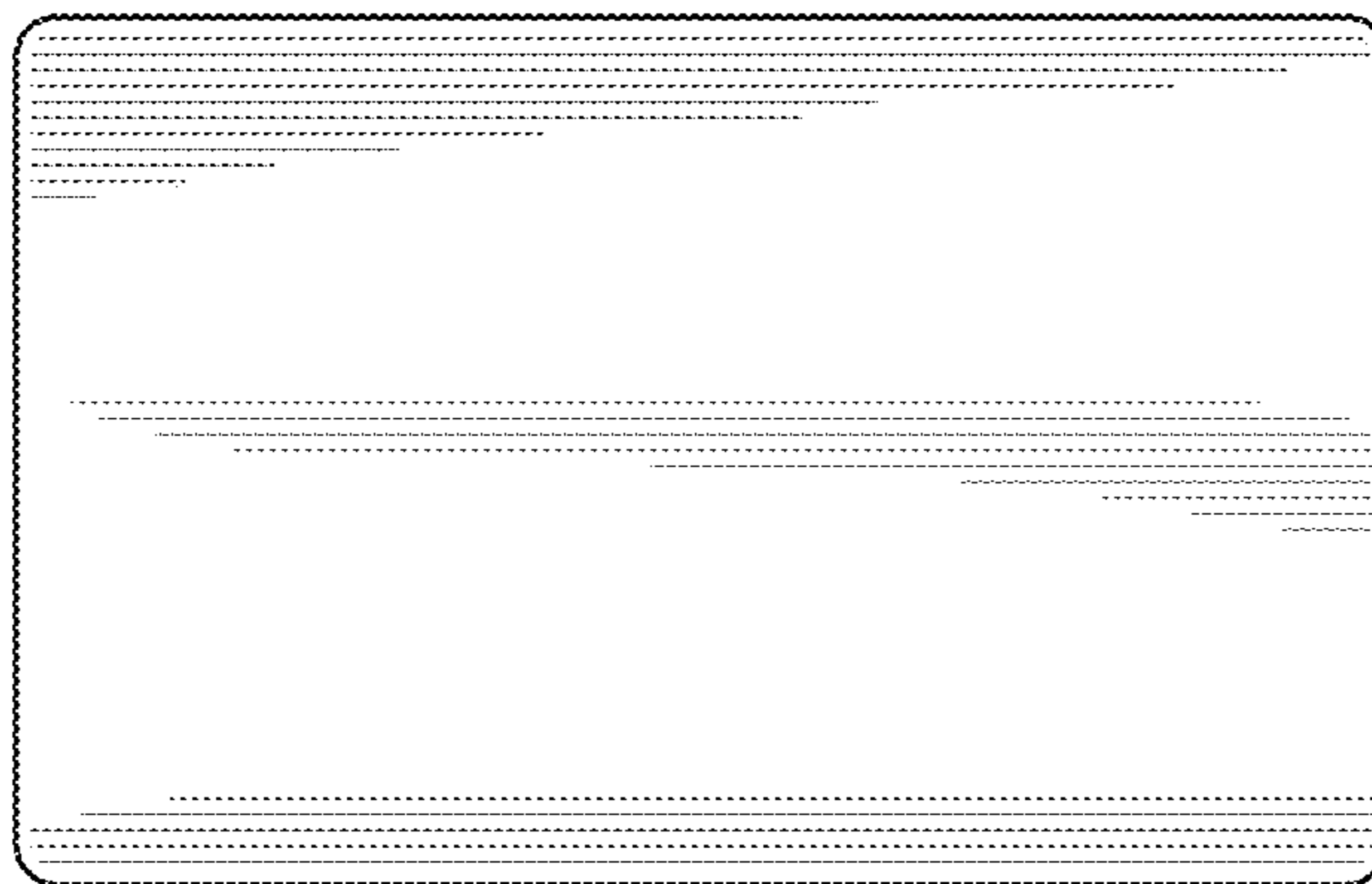

FIG. 24



FIG. 28

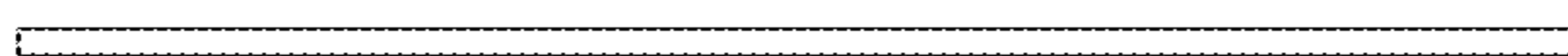

FIG. 26



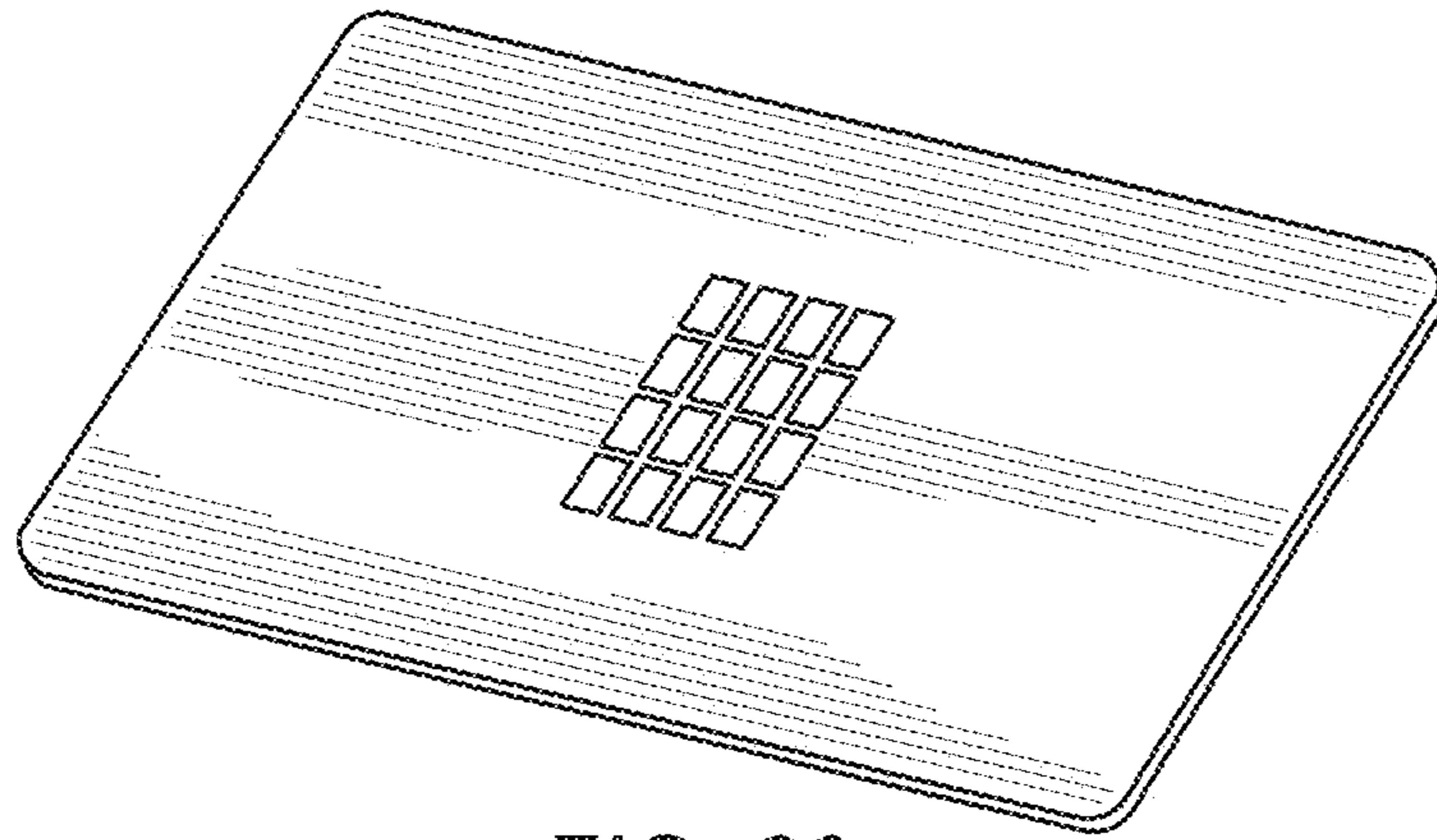

FIG. 29

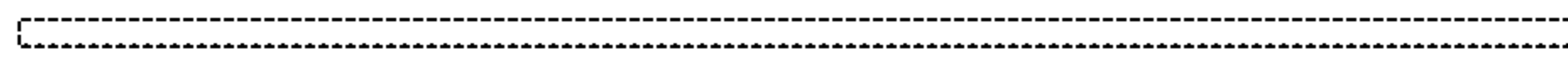

FIG. 32

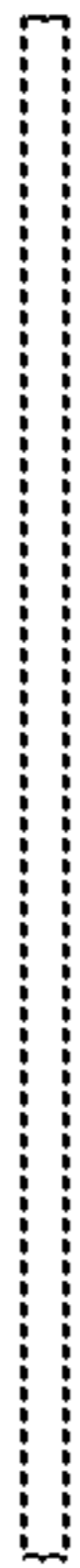

FIG. 34

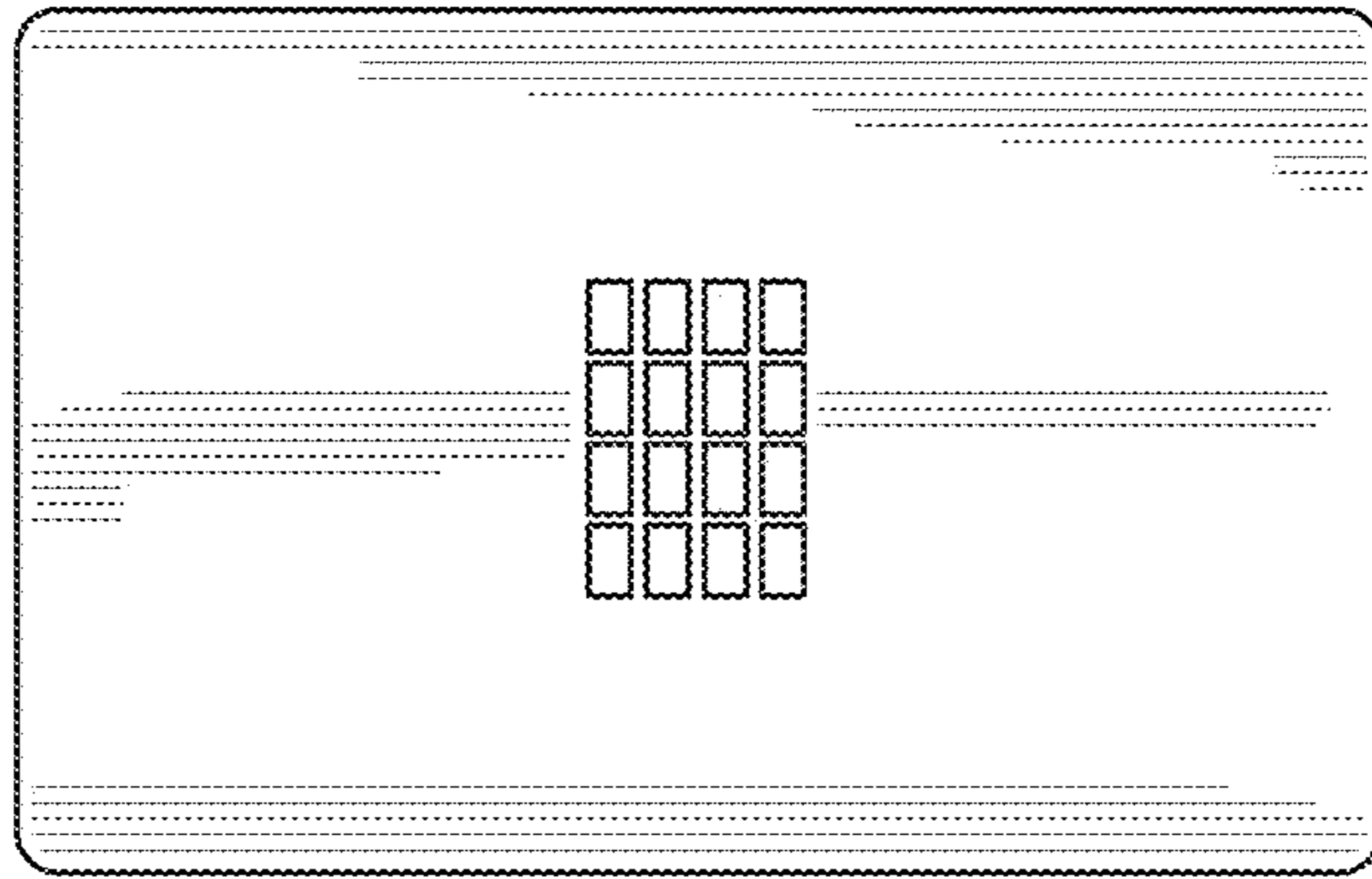

FIG. 30

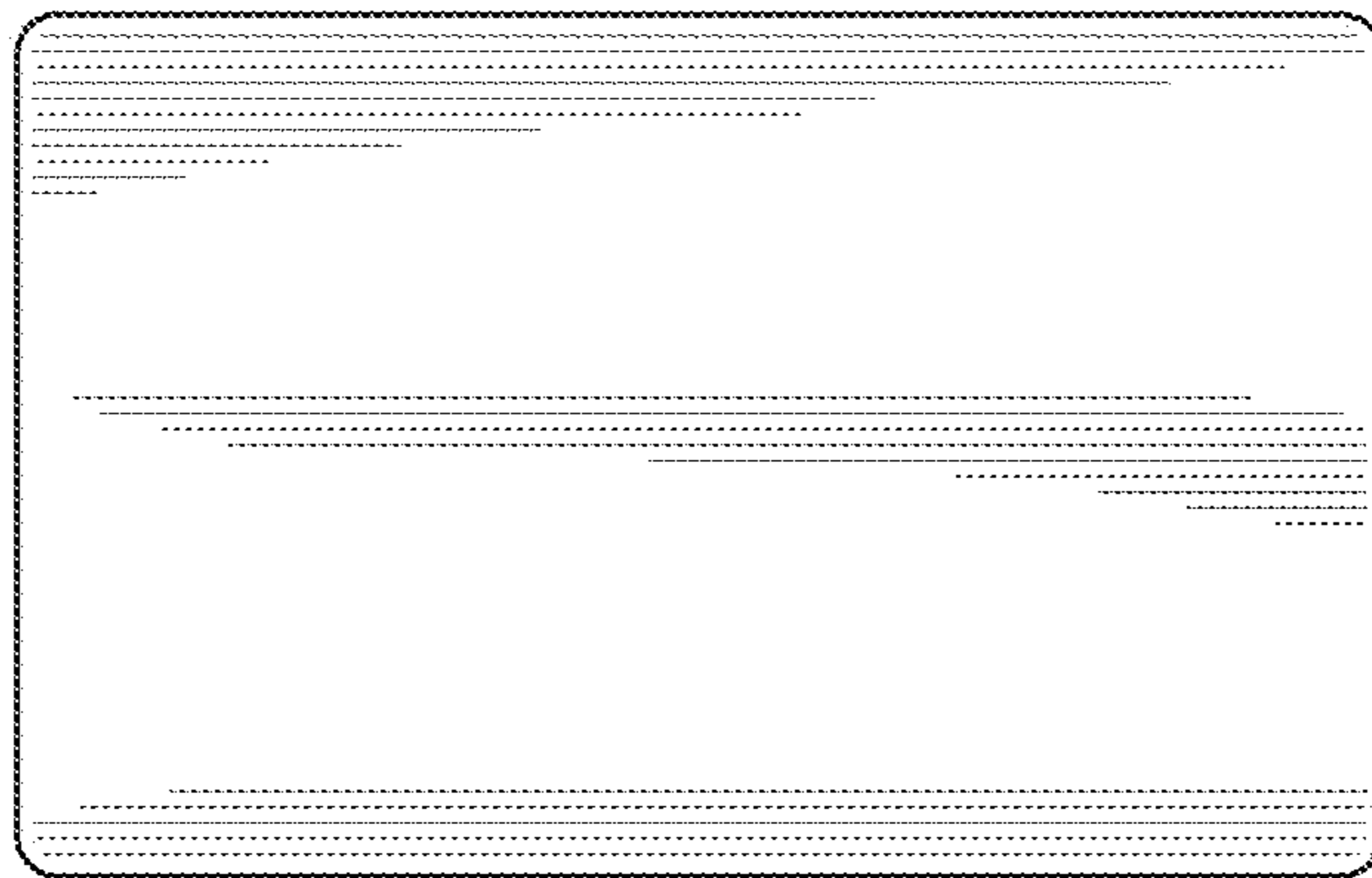

FIG. 31

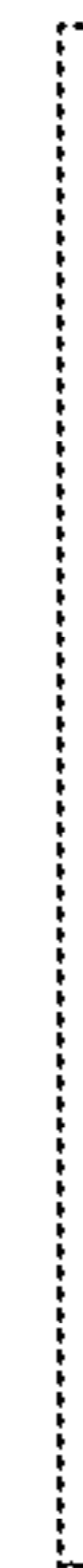

FIG. 35

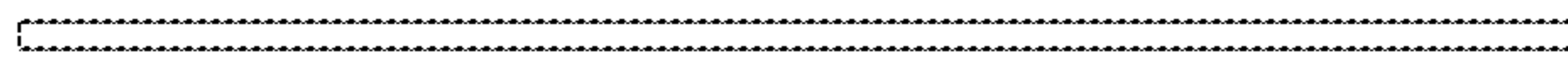

FIG. 33

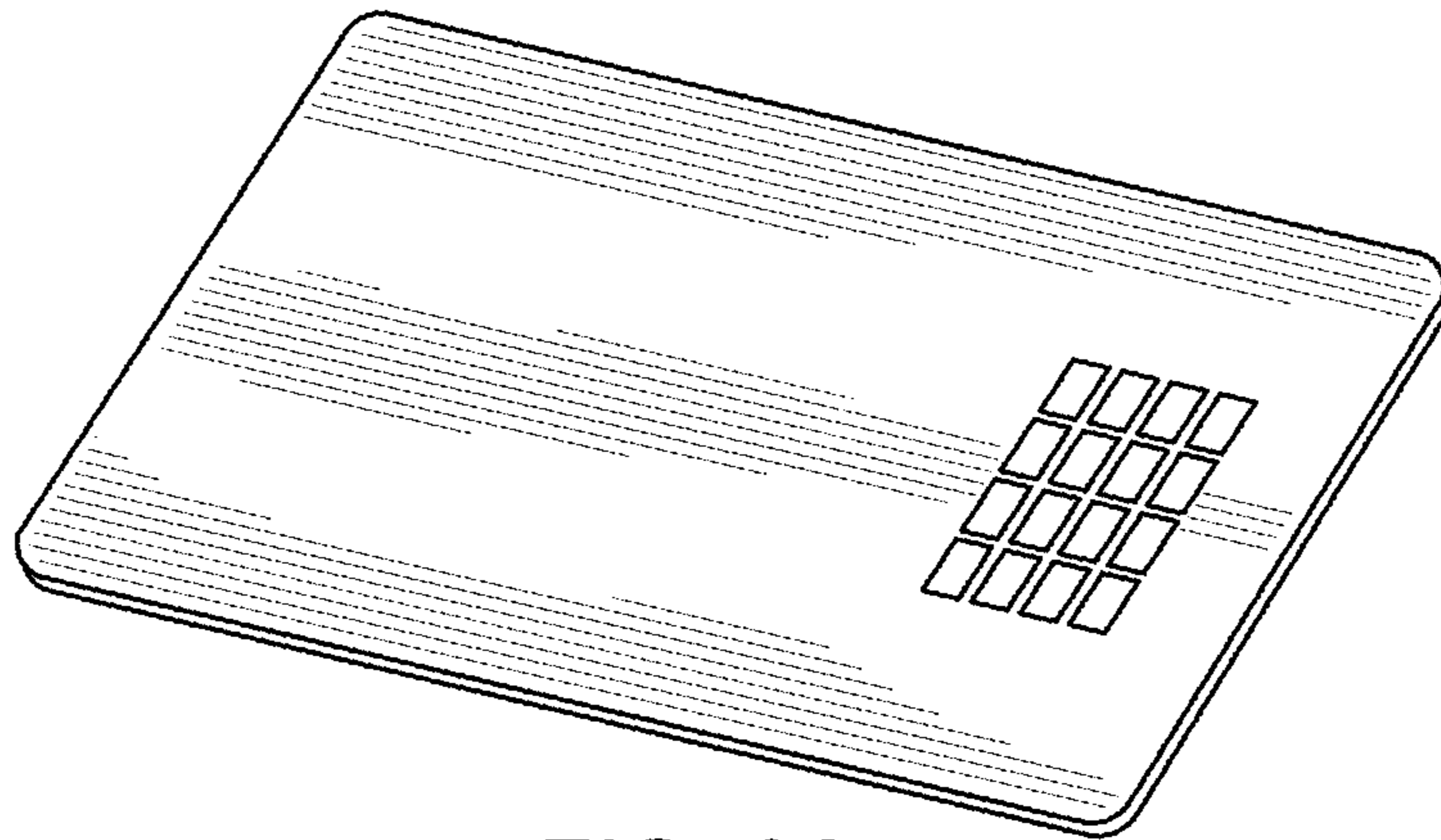

FIG. 36

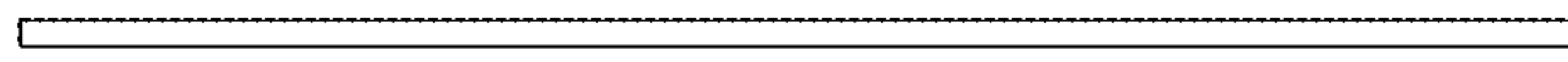

FIG. 39

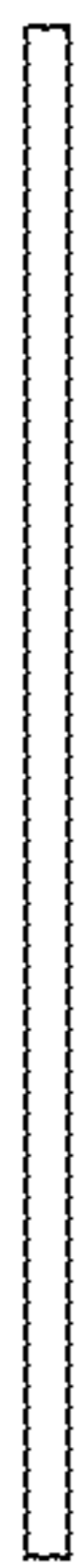

FIG. 41

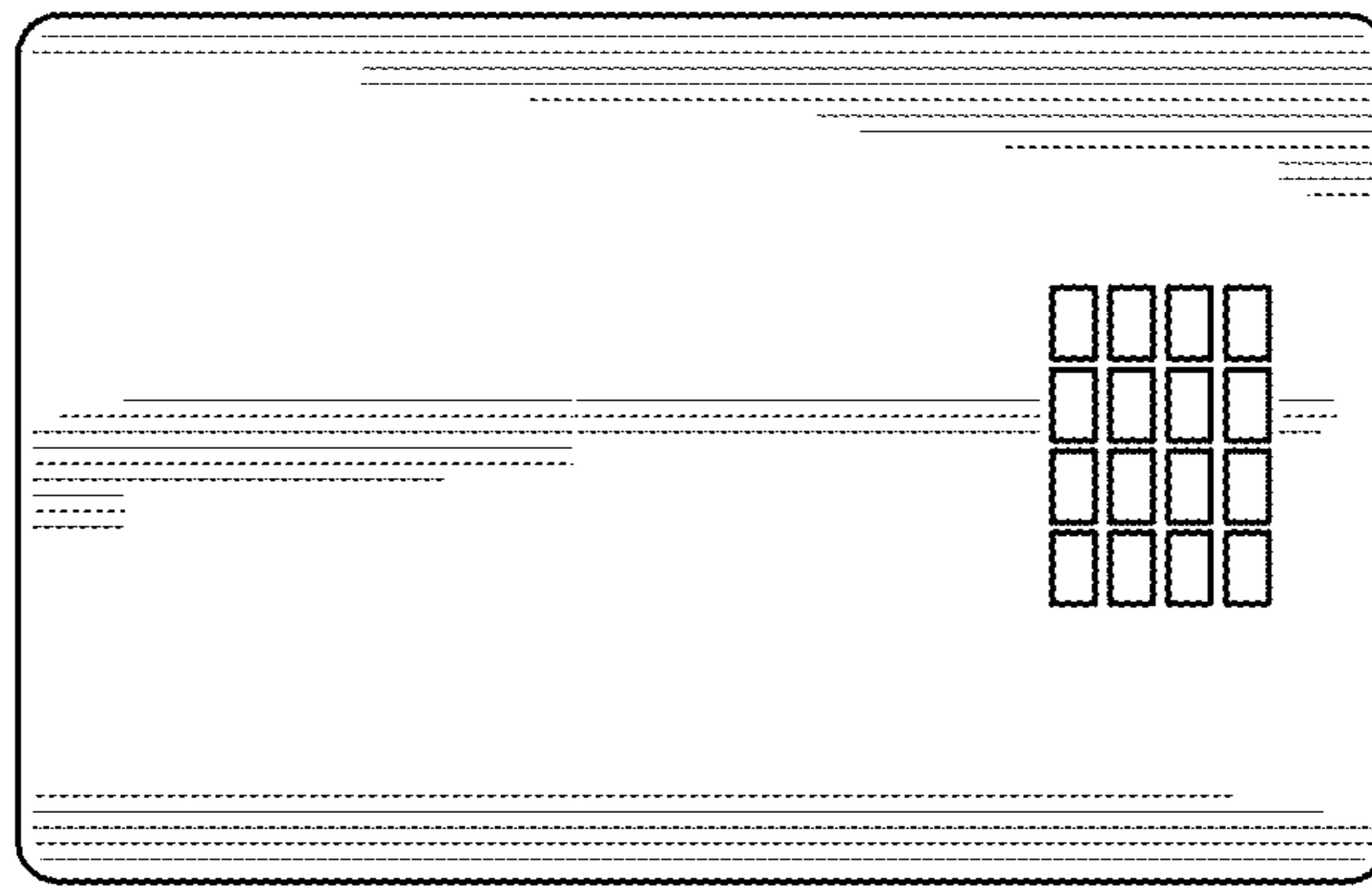

FIG. 37

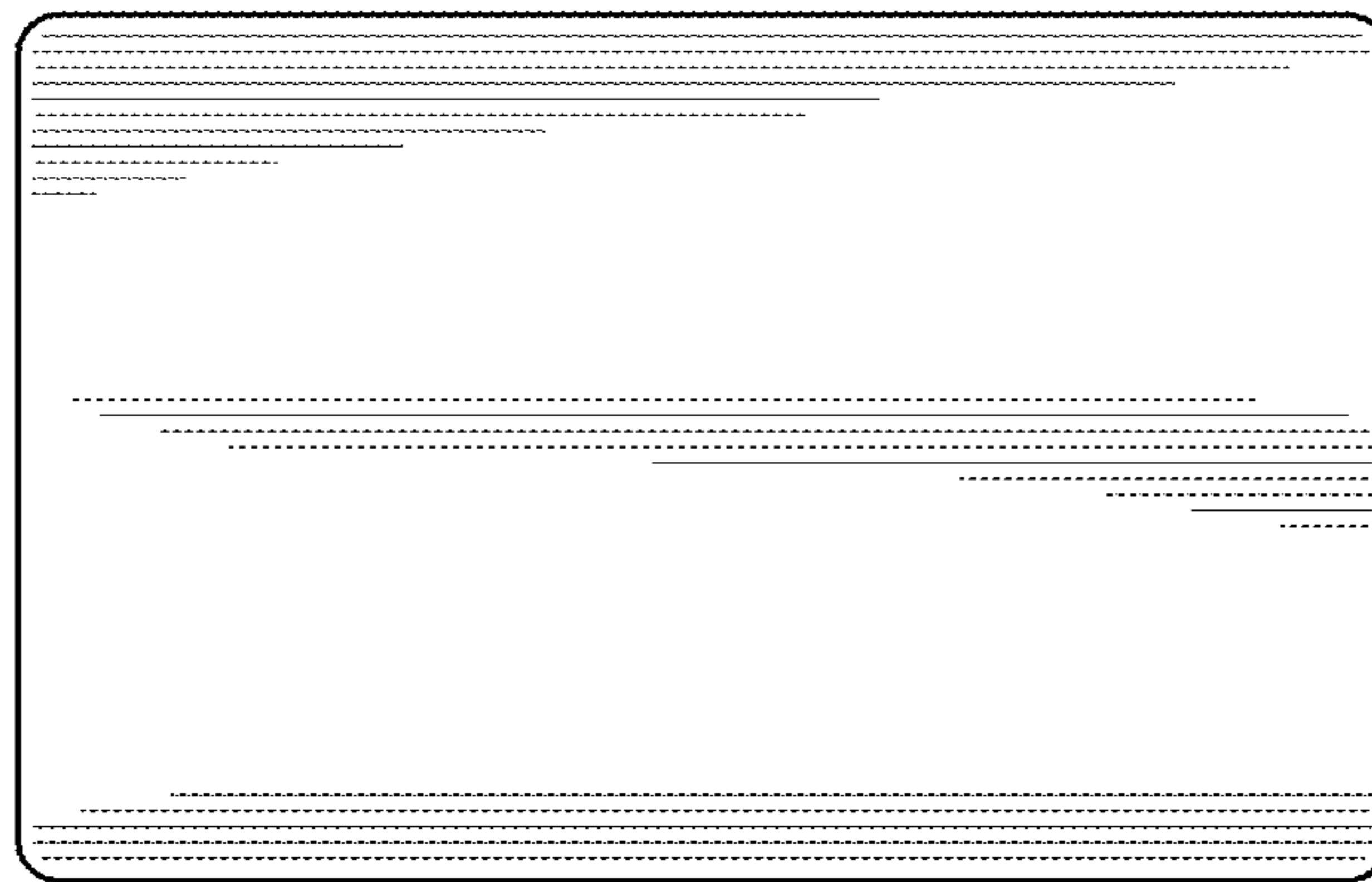

FIG. 38



FIG. 42

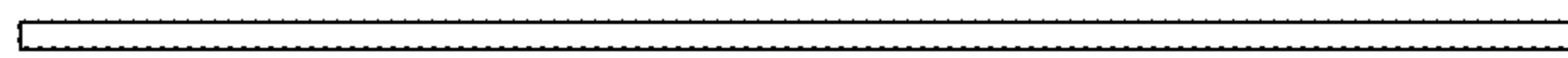

FIG. 40

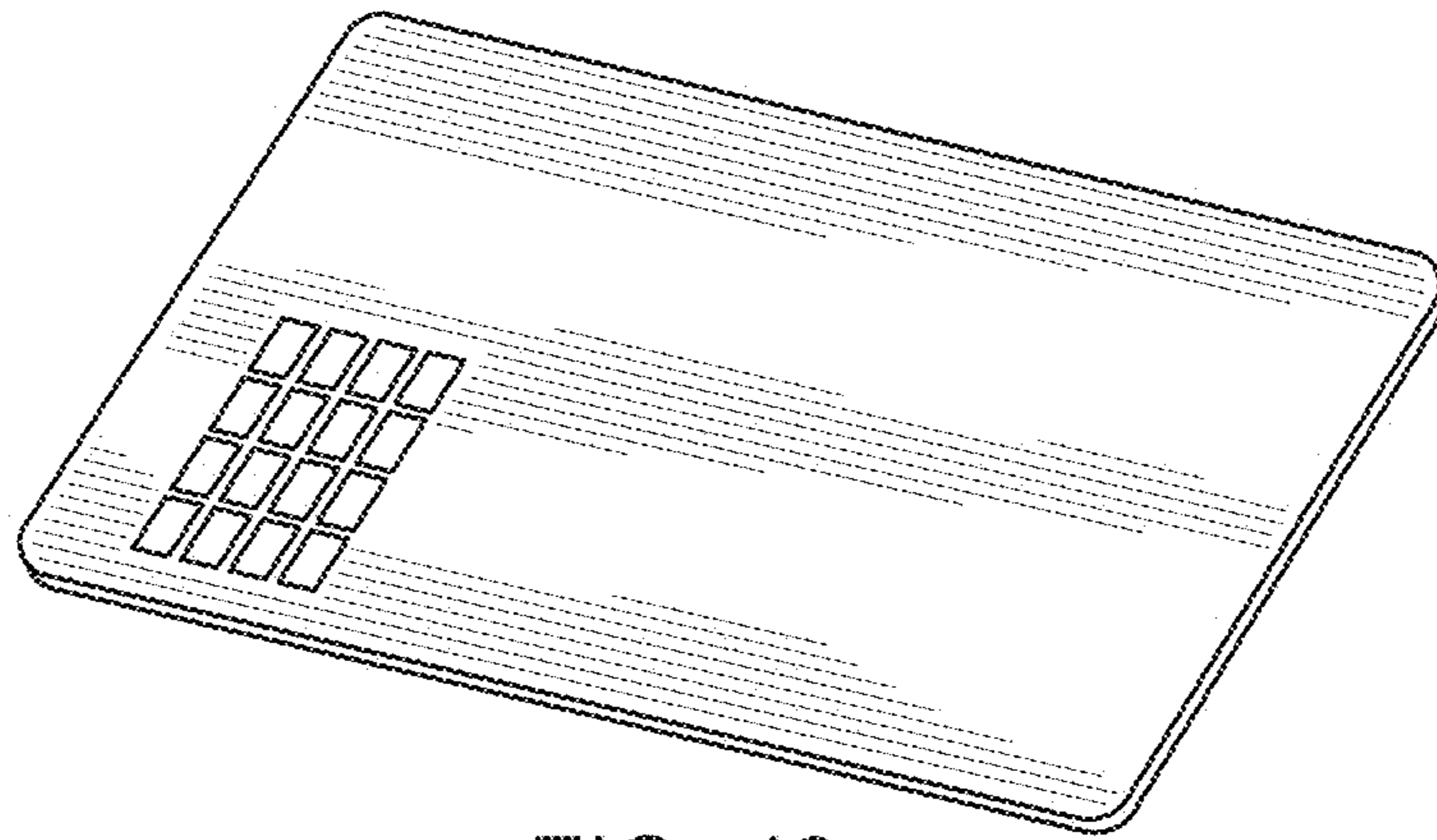

FIG. 43

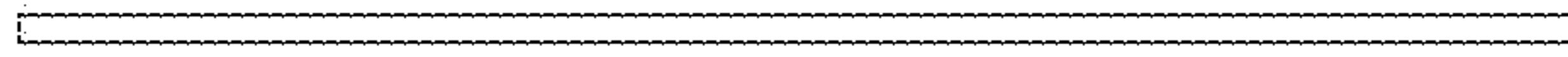

FIG. 46



FIG. 48

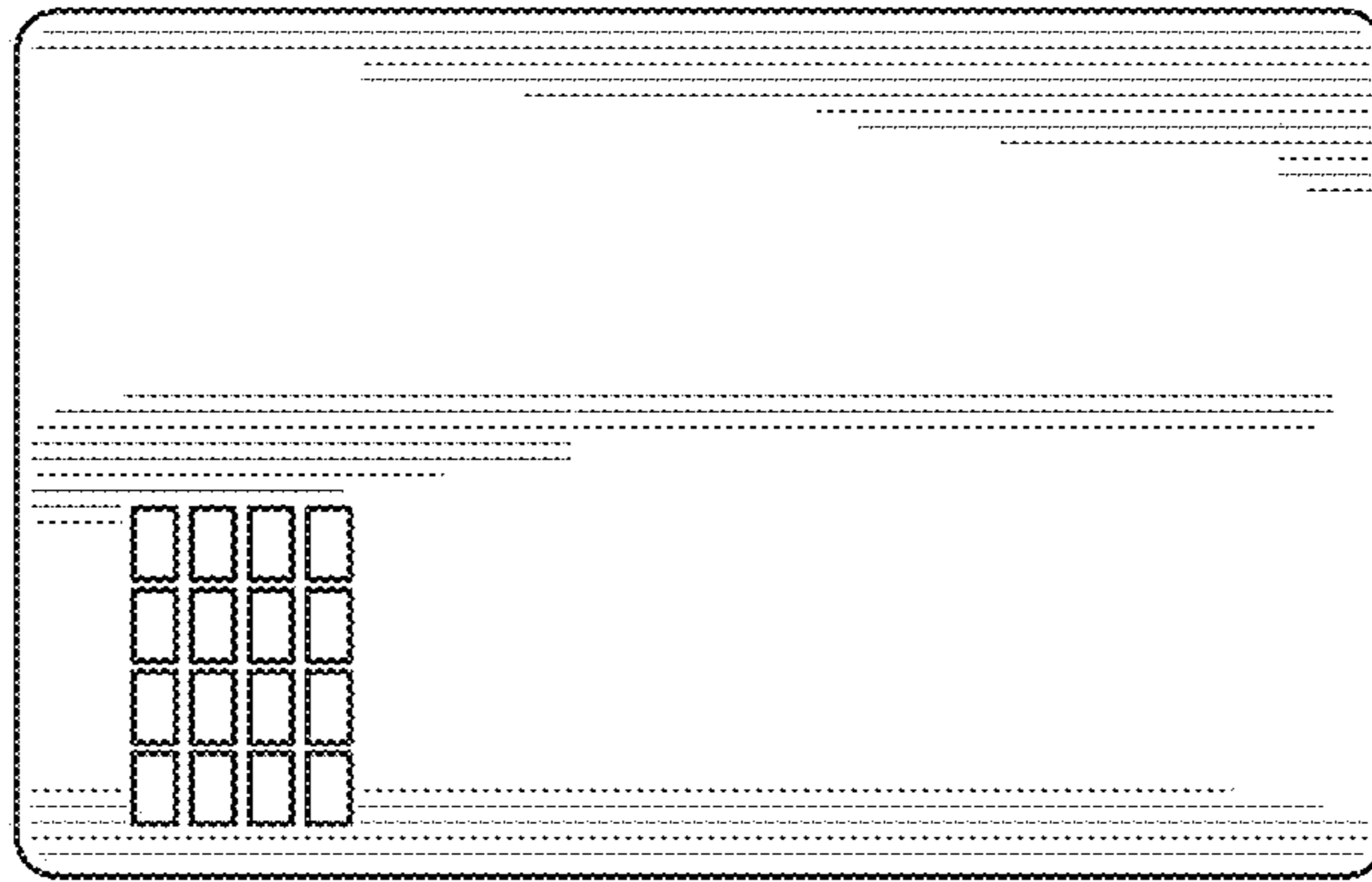

FIG. 44

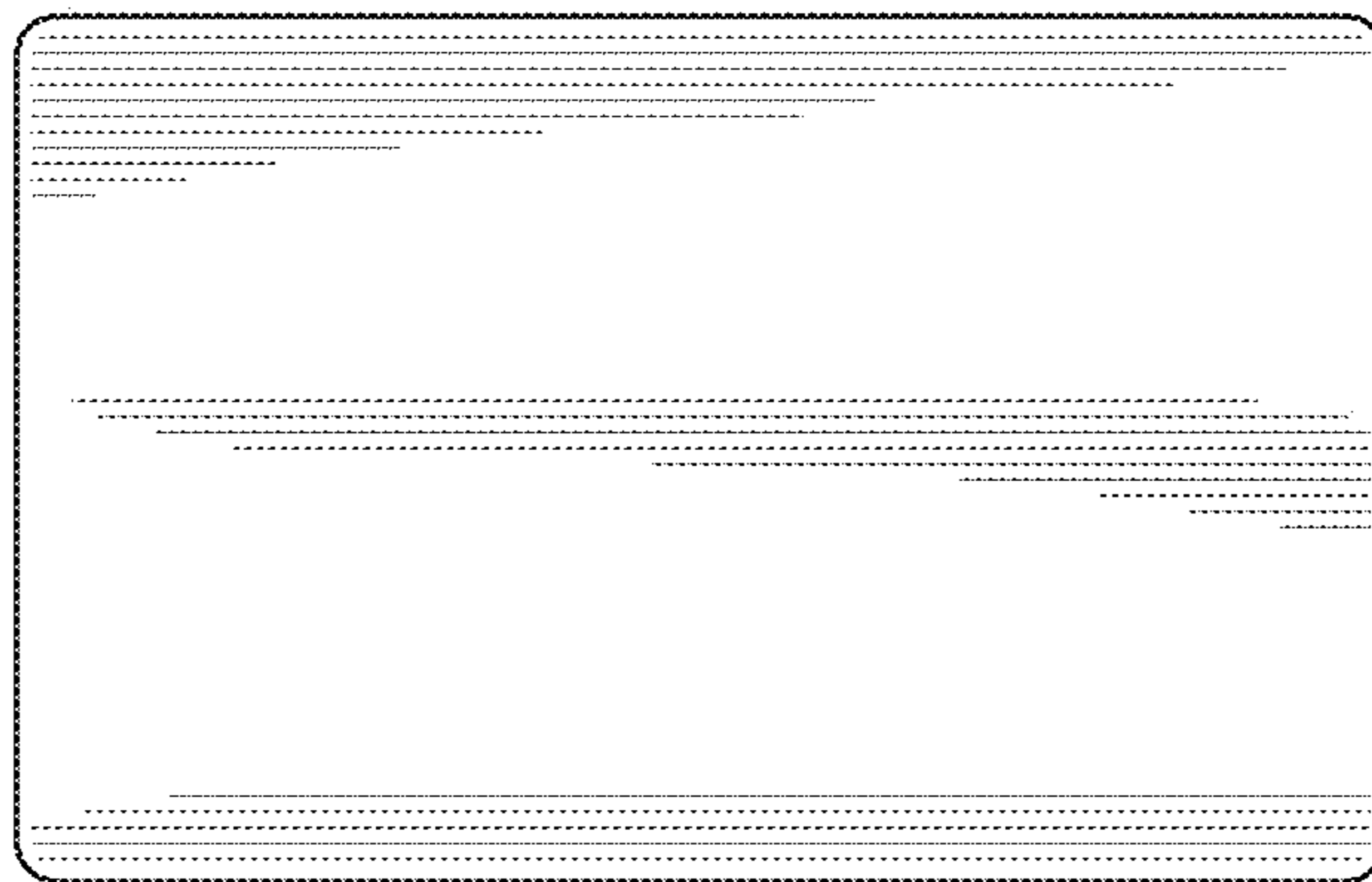

FIG. 45



FIG. 49

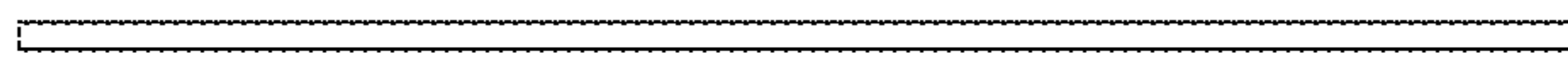

FIG. 47

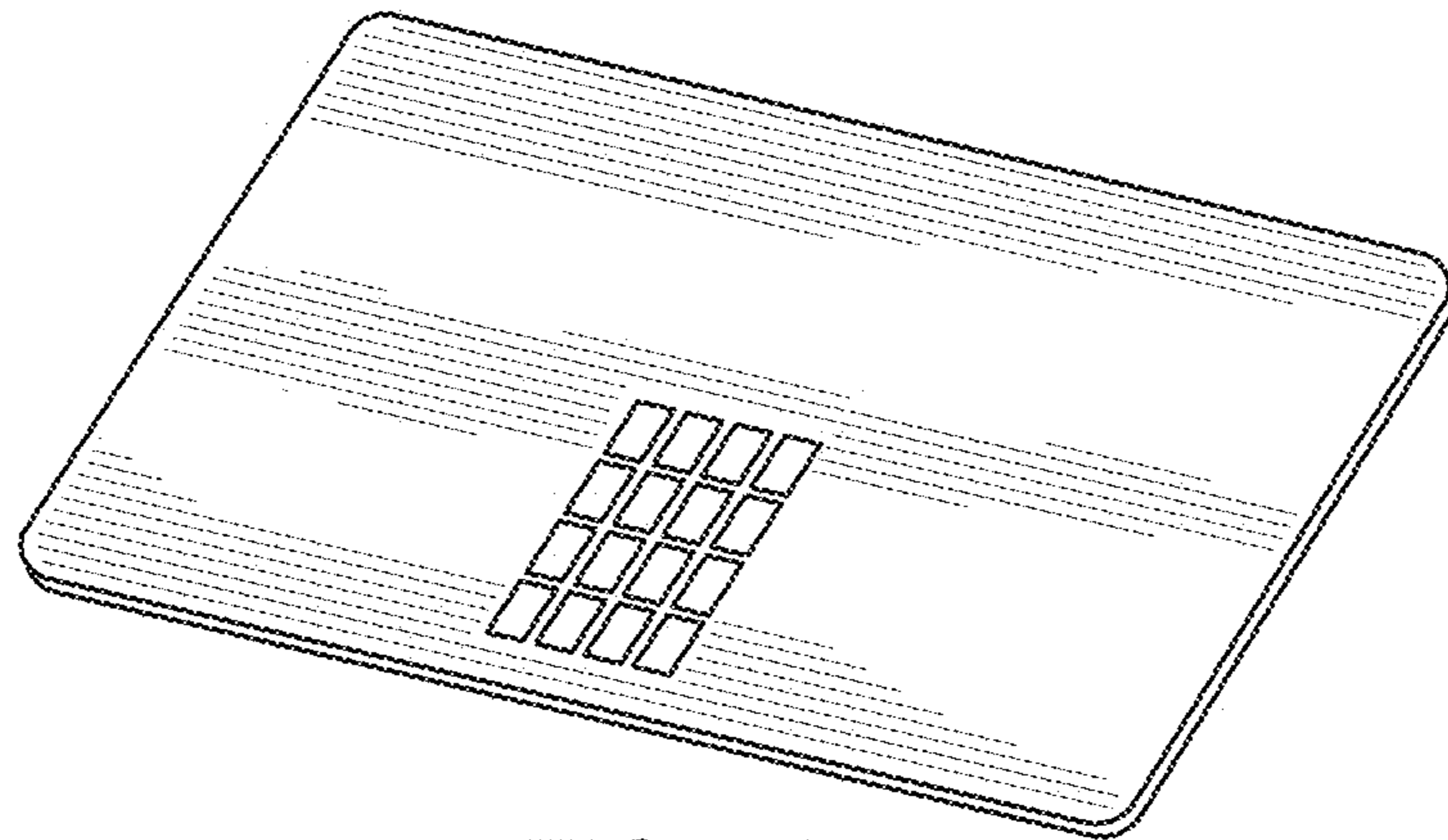

FIG. 50

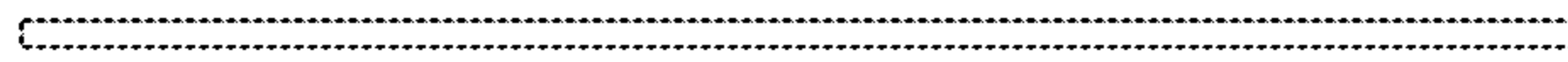

FIG. 53

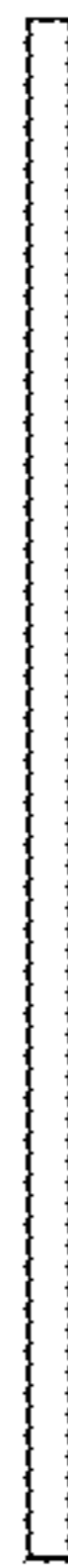

FIG. 55

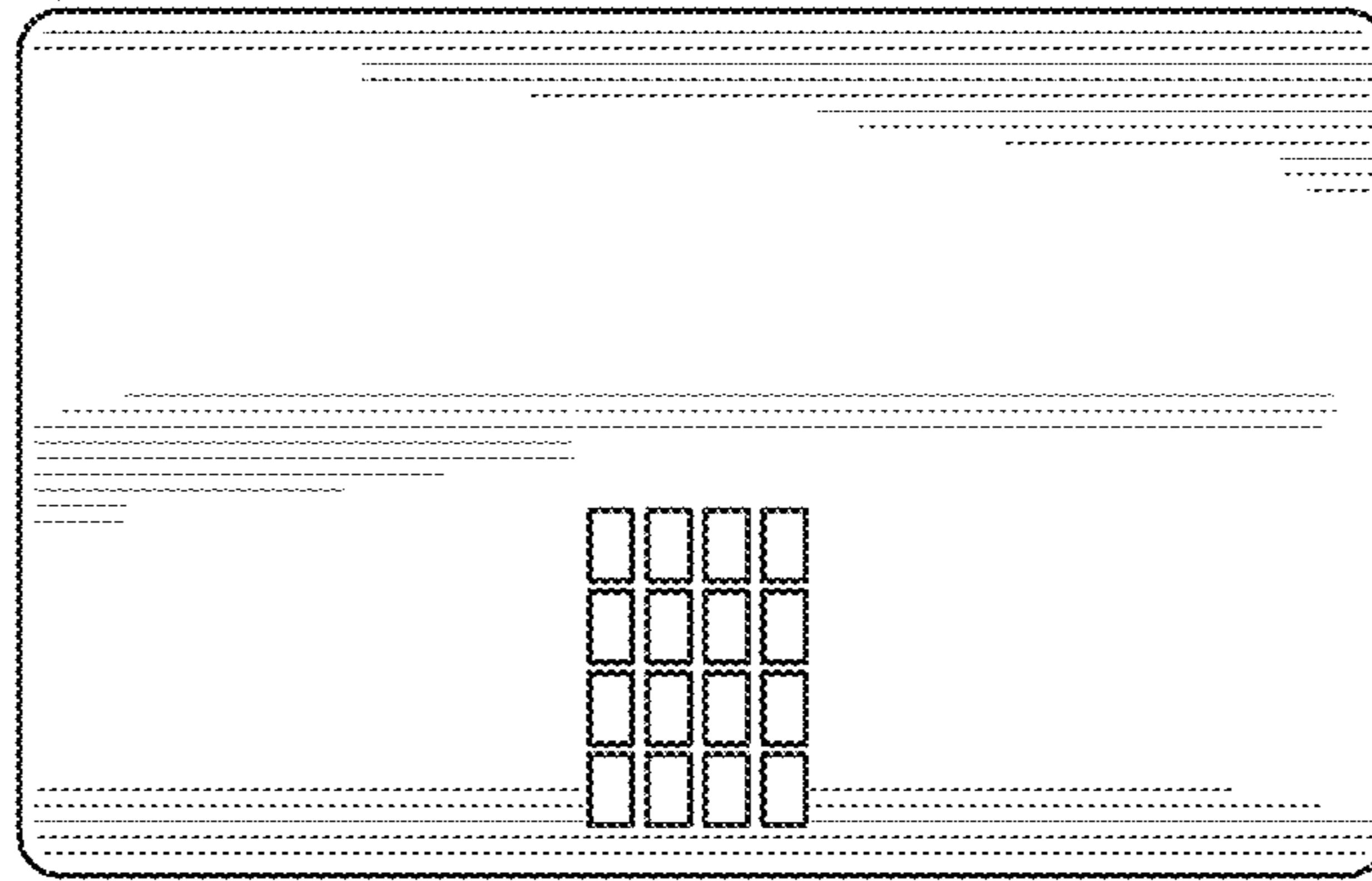

FIG. 51

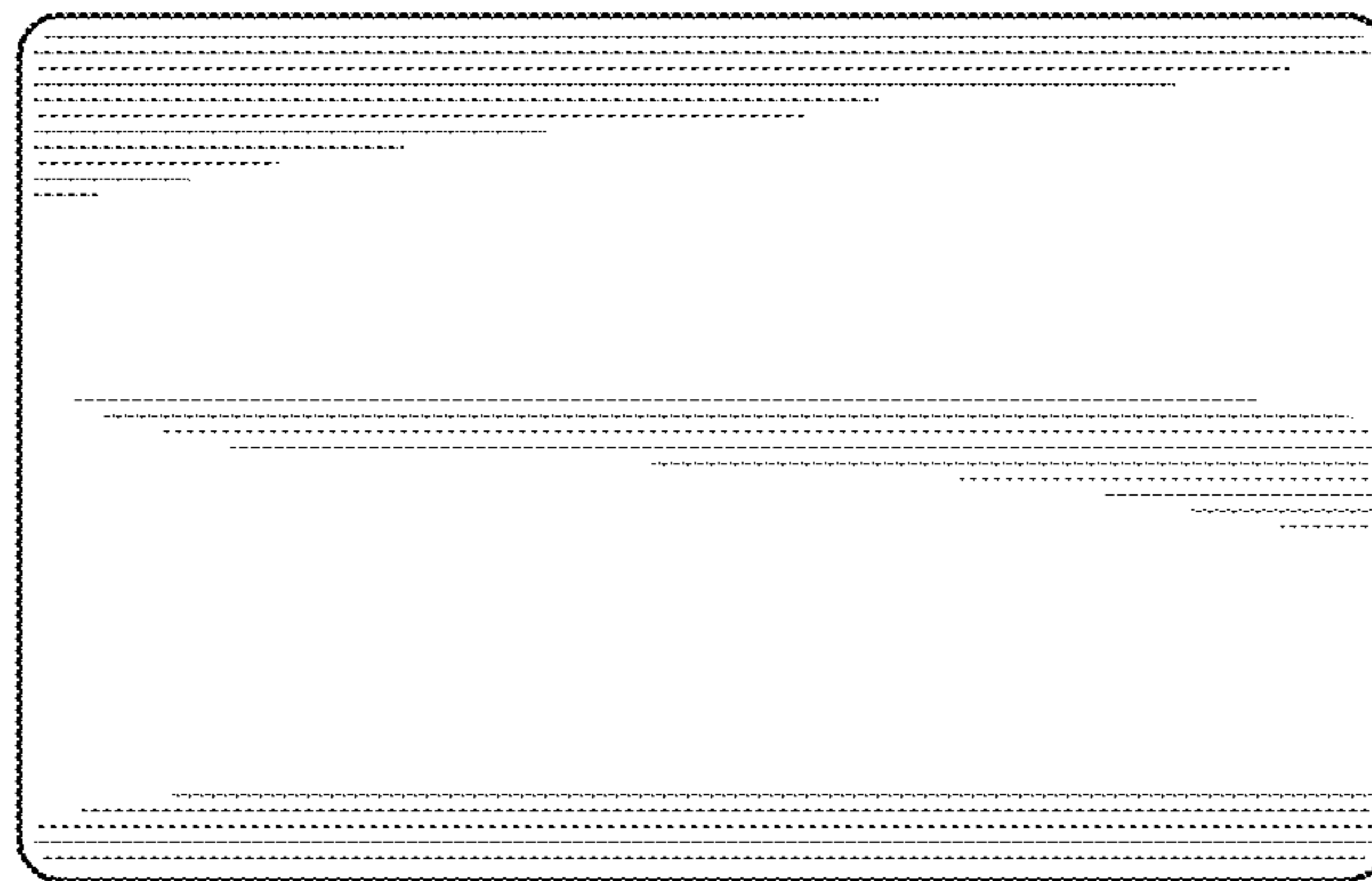

FIG. 52



FIG. 56

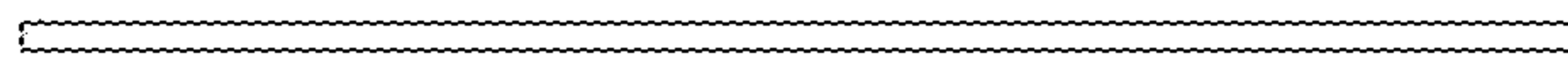

FIG. 54

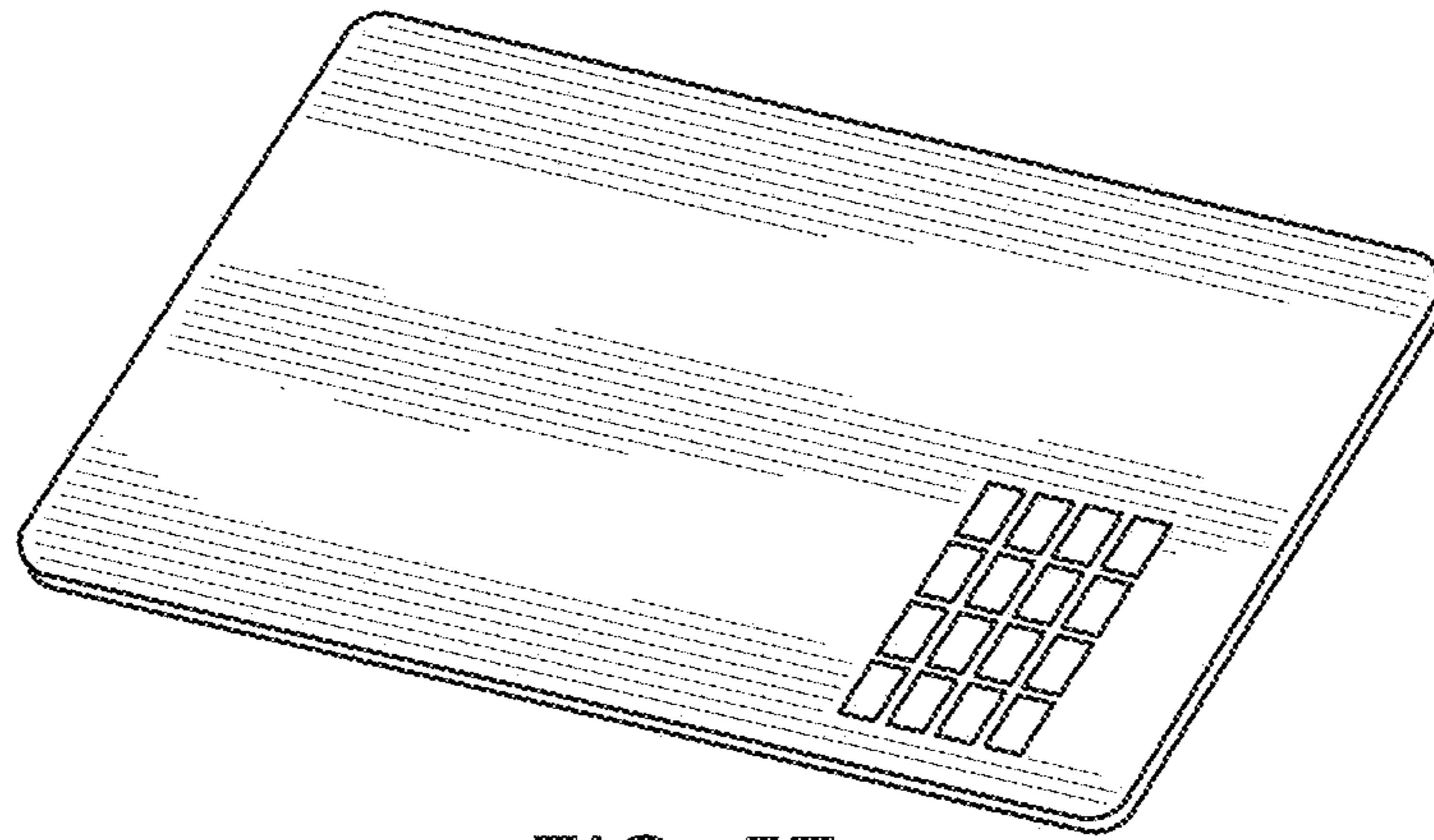

FIG. 57

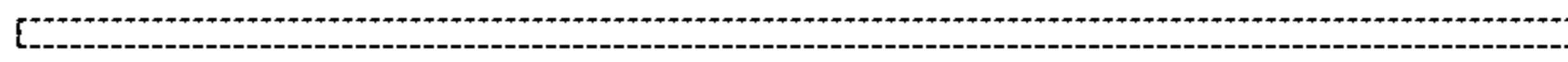

FIG. 60



FIG. 62

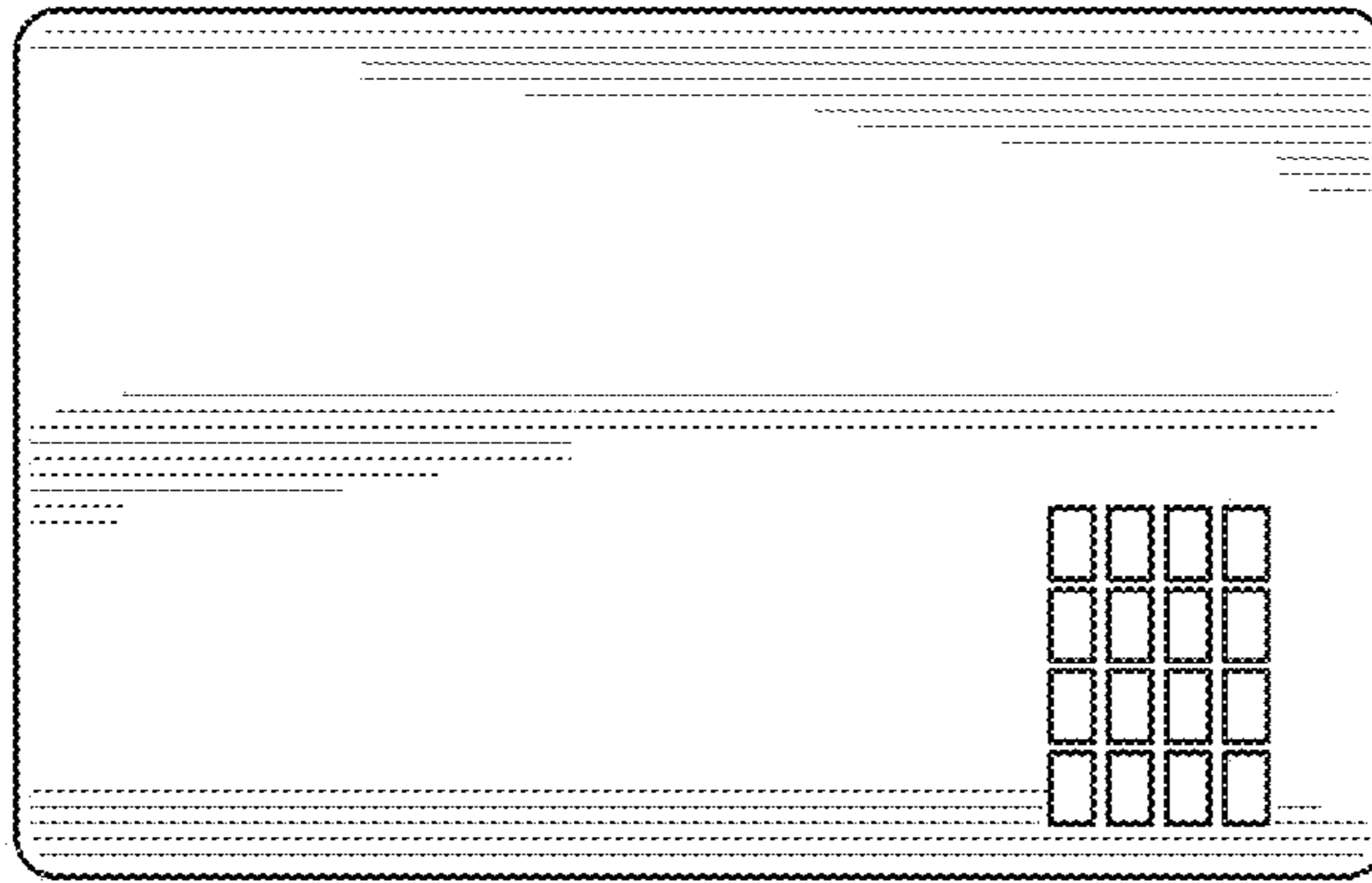

FIG. 58

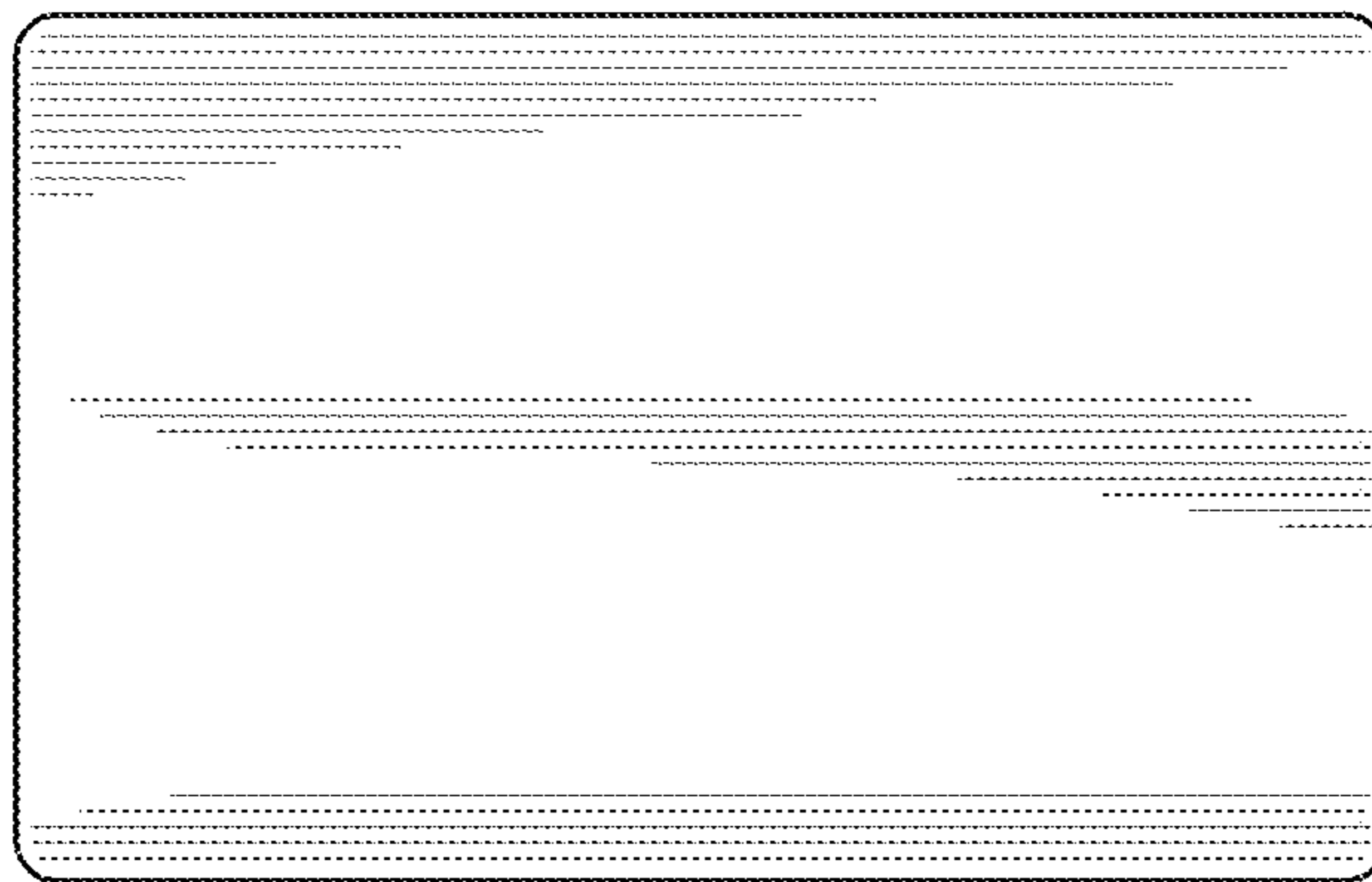

FIG. 59

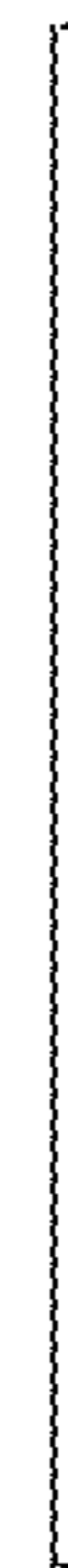

FIG. 63

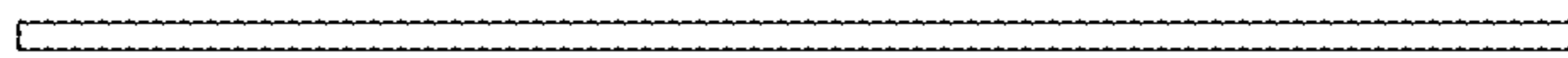

FIG. 61

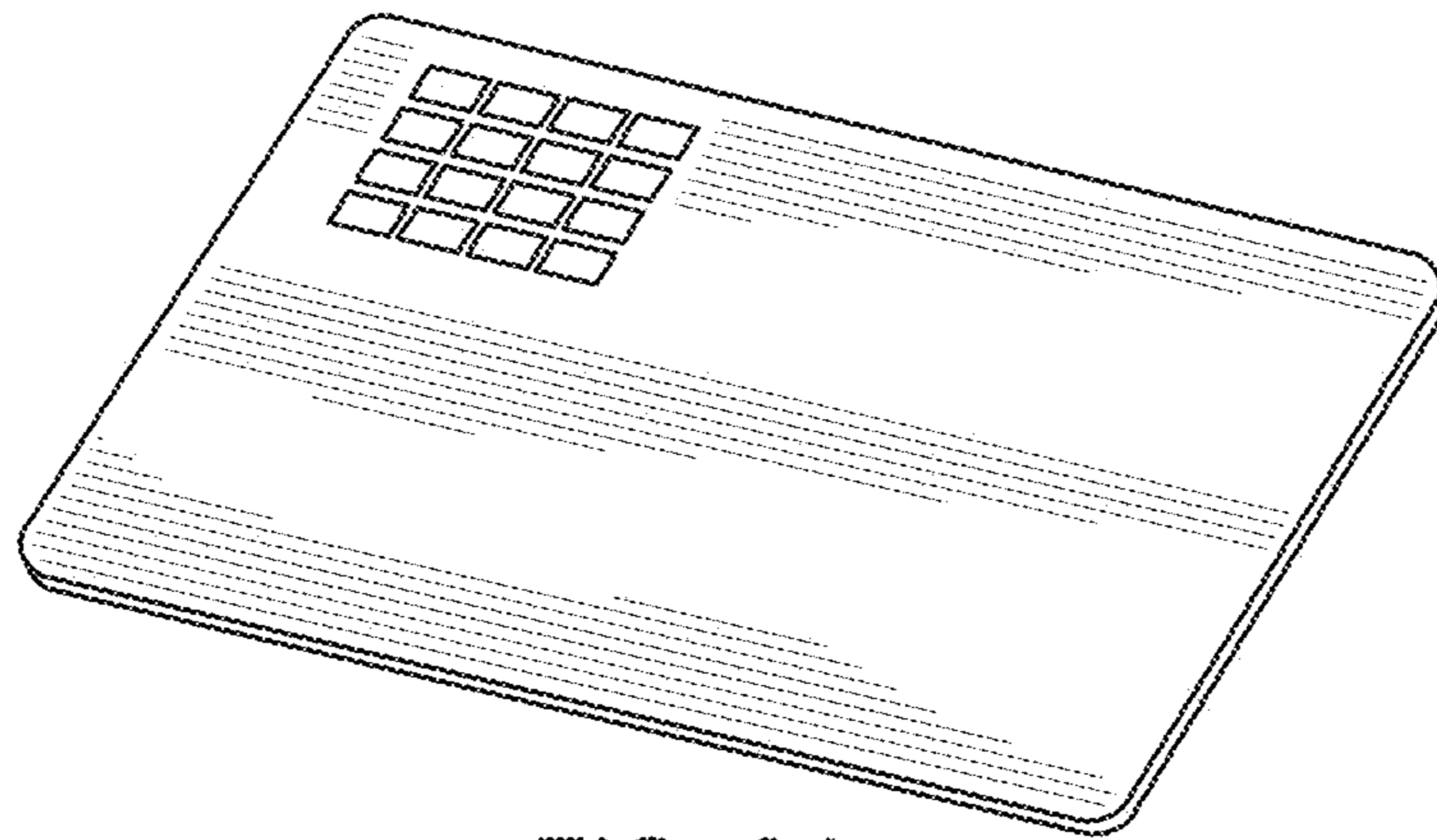

FIG. 64

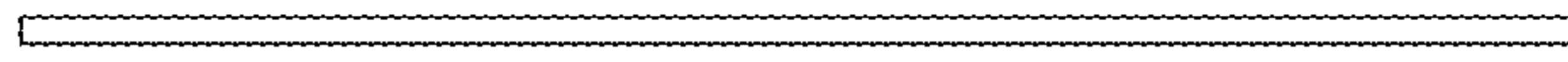

FIG. 67

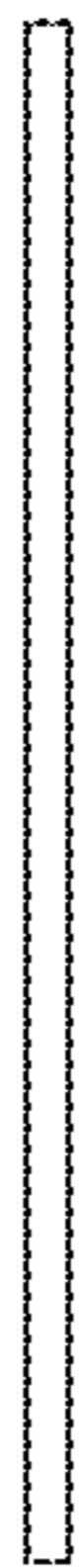

FIG. 69

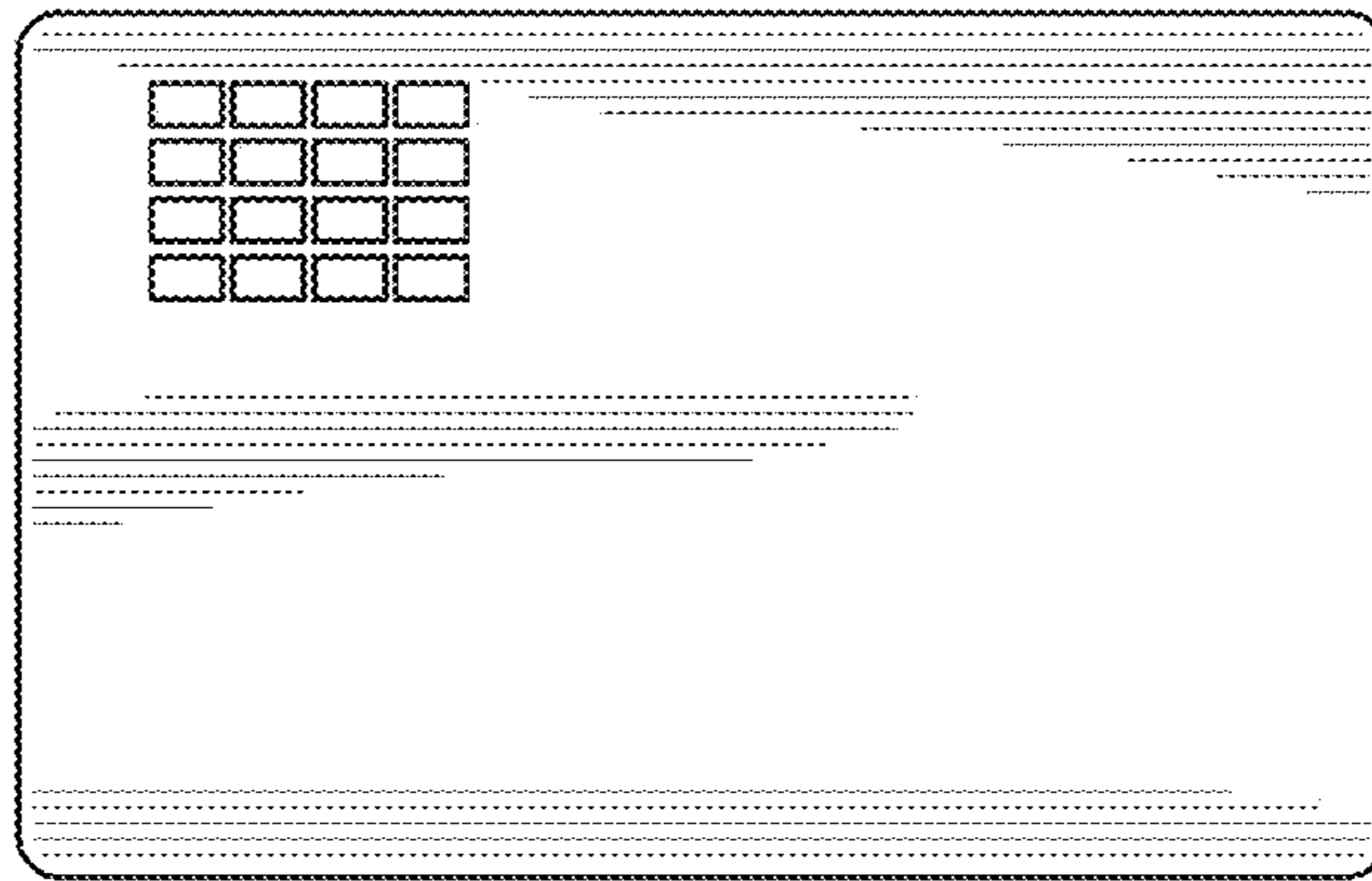

FIG. 65

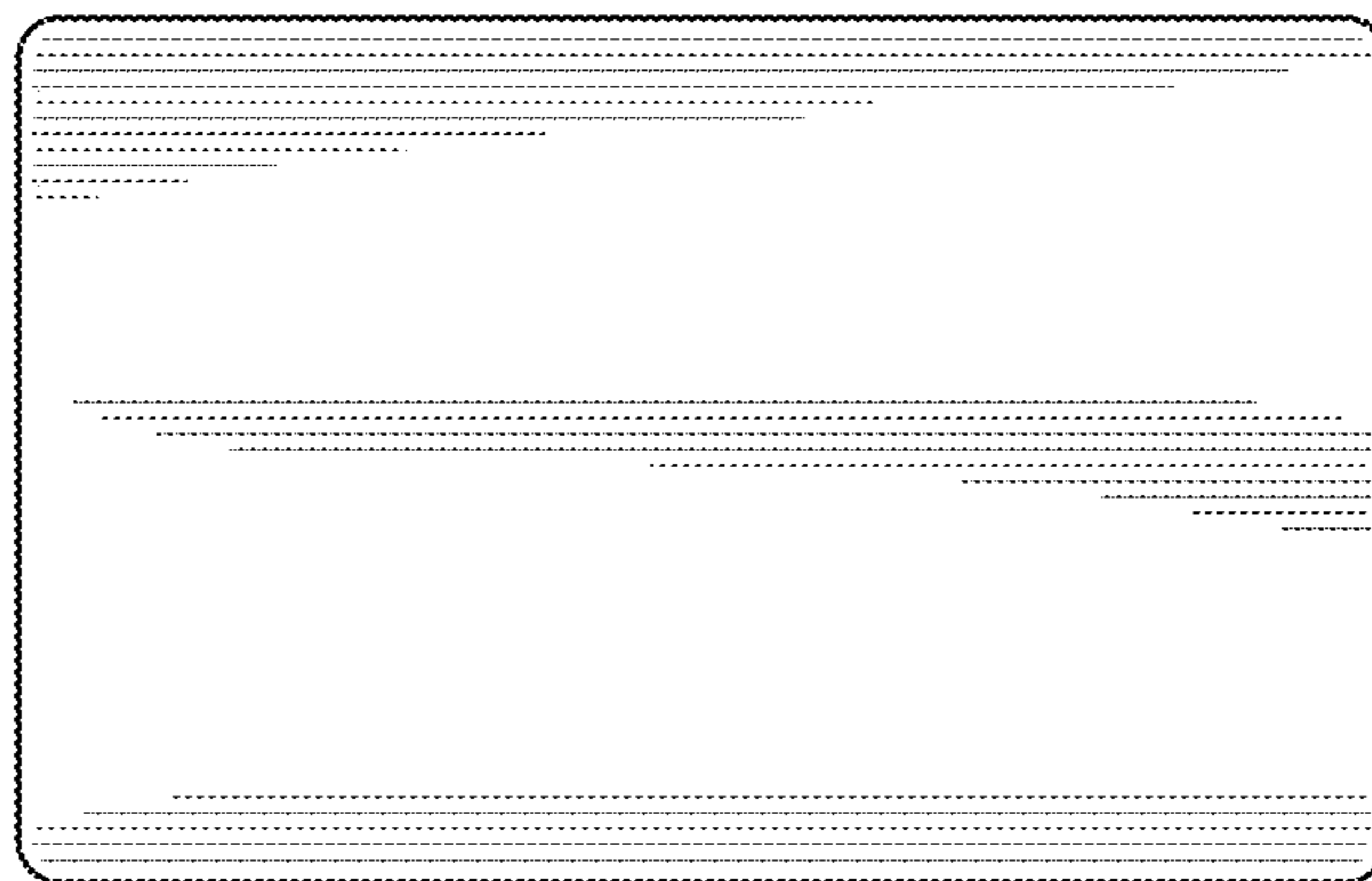

FIG. 66

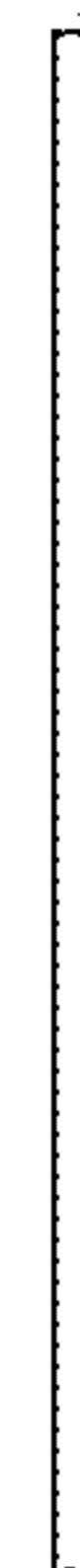

FIG. 70

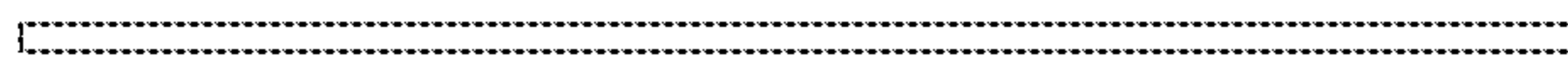

FIG. 68

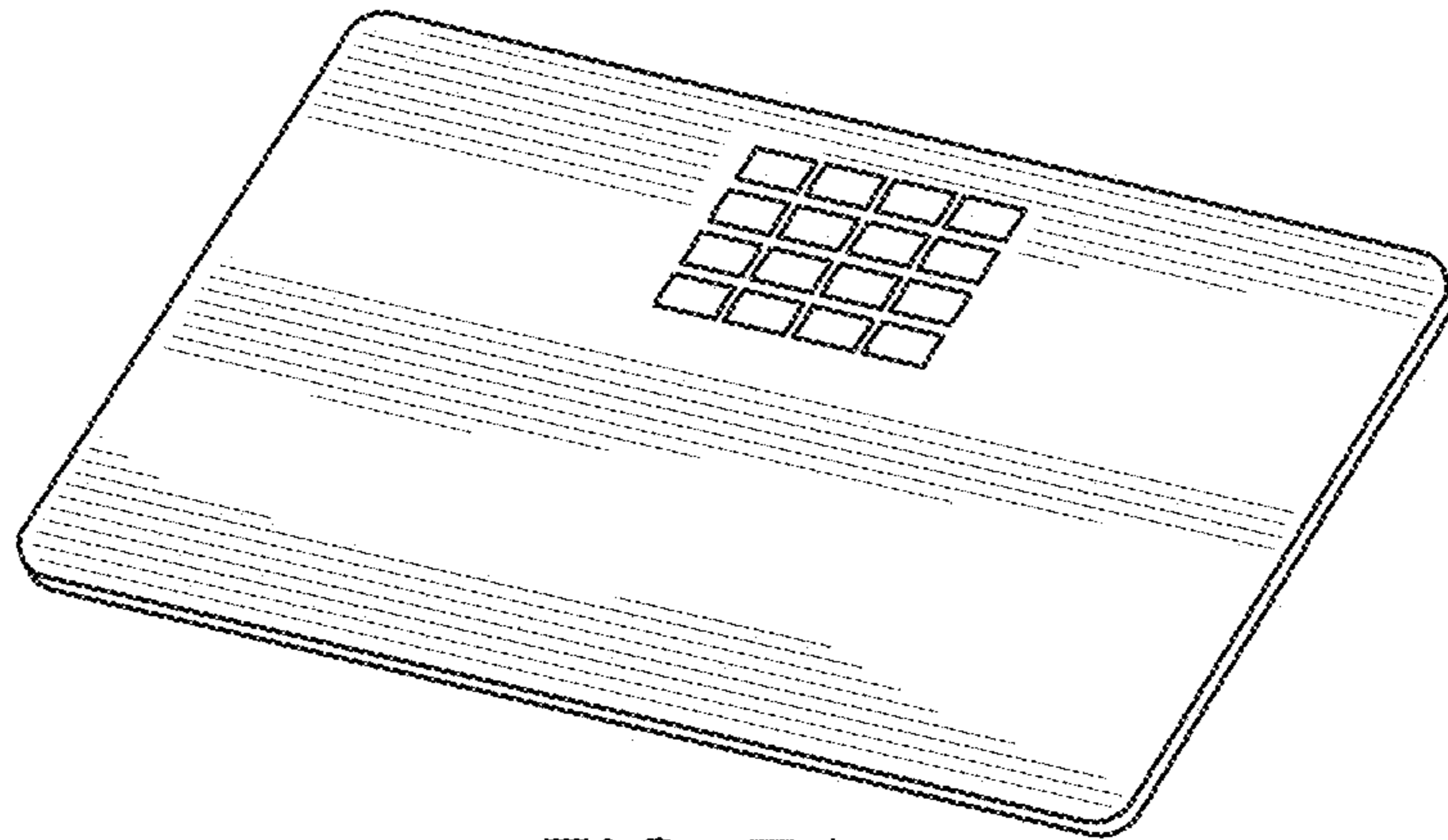

FIG. 71

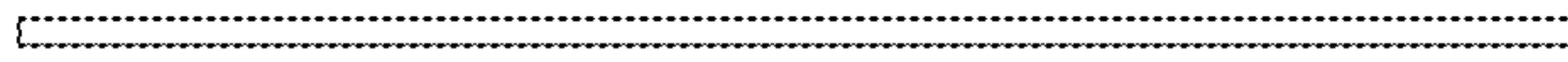

FIG. 74

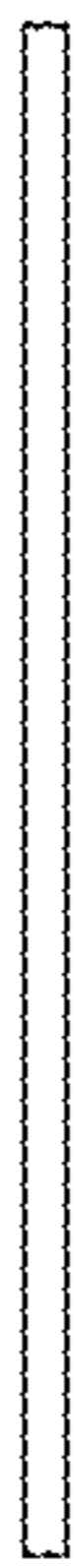

FIG. 76

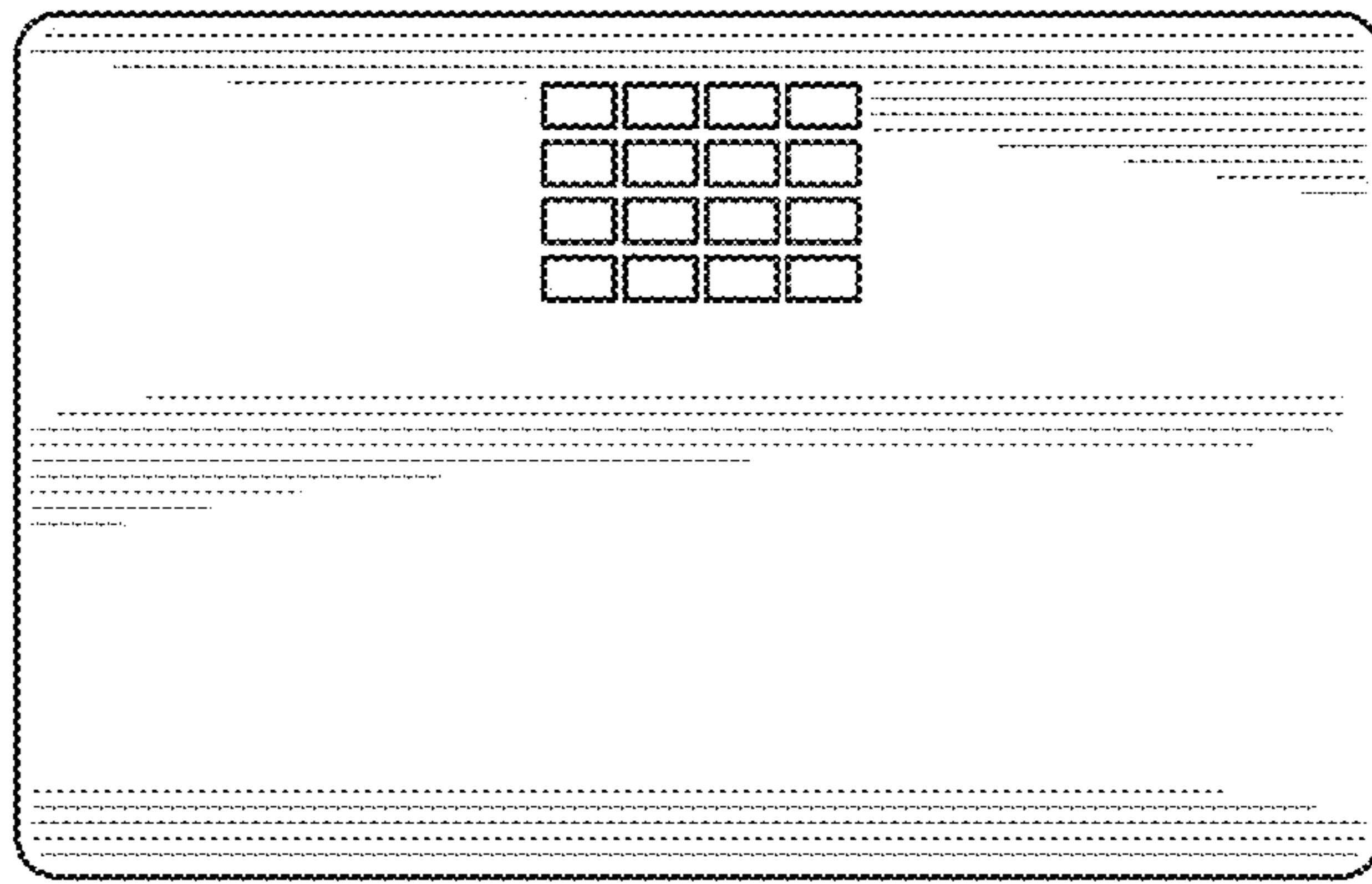

FIG. 72

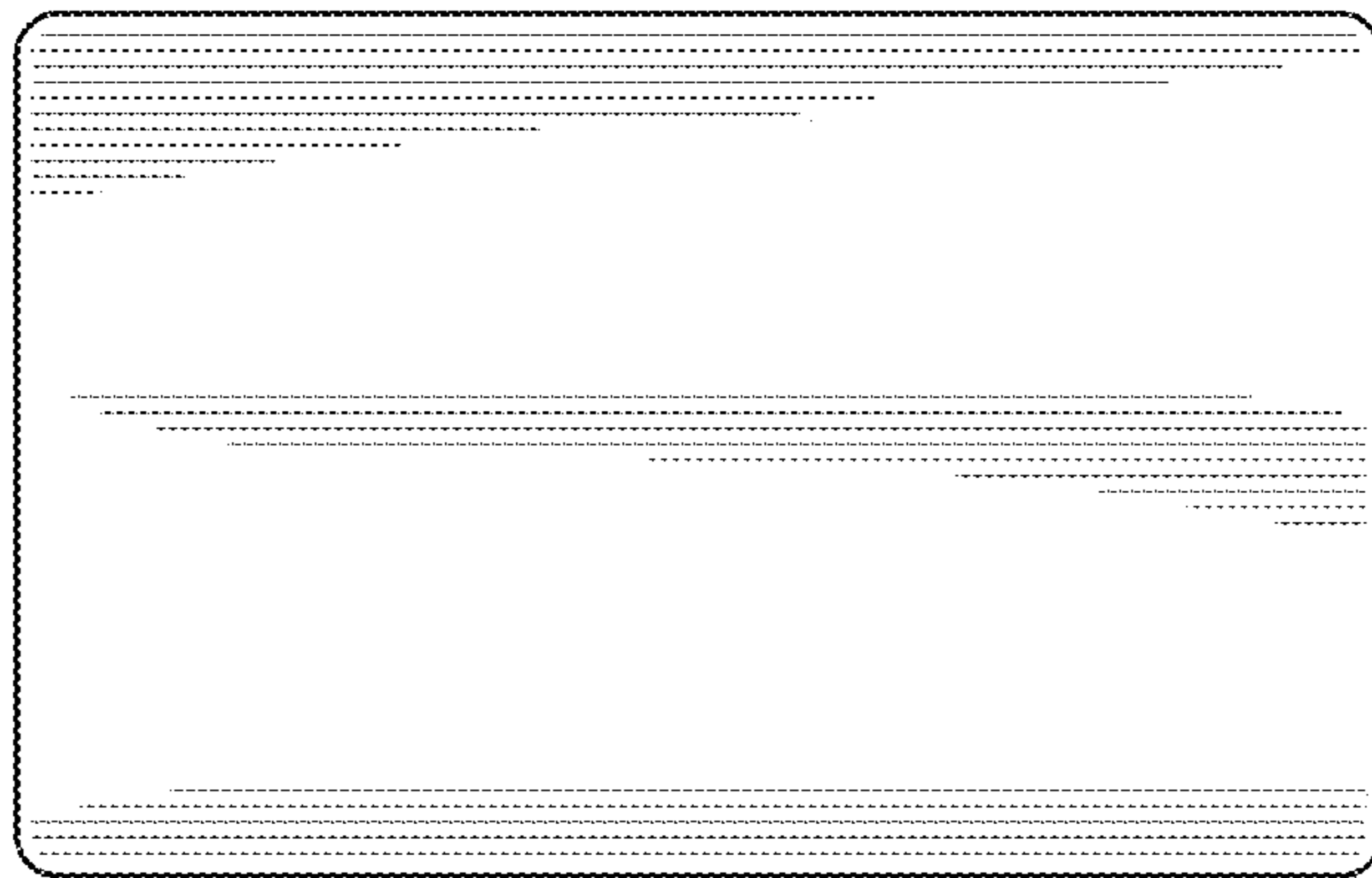

FIG. 73

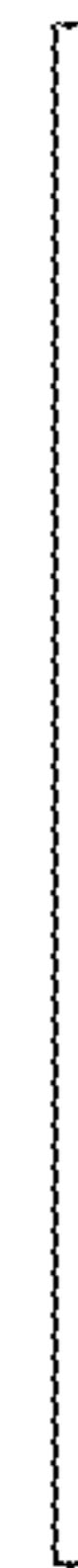

FIG. 77

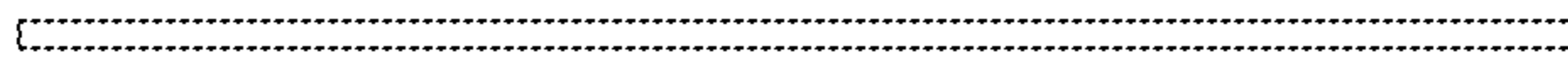

FIG. 75

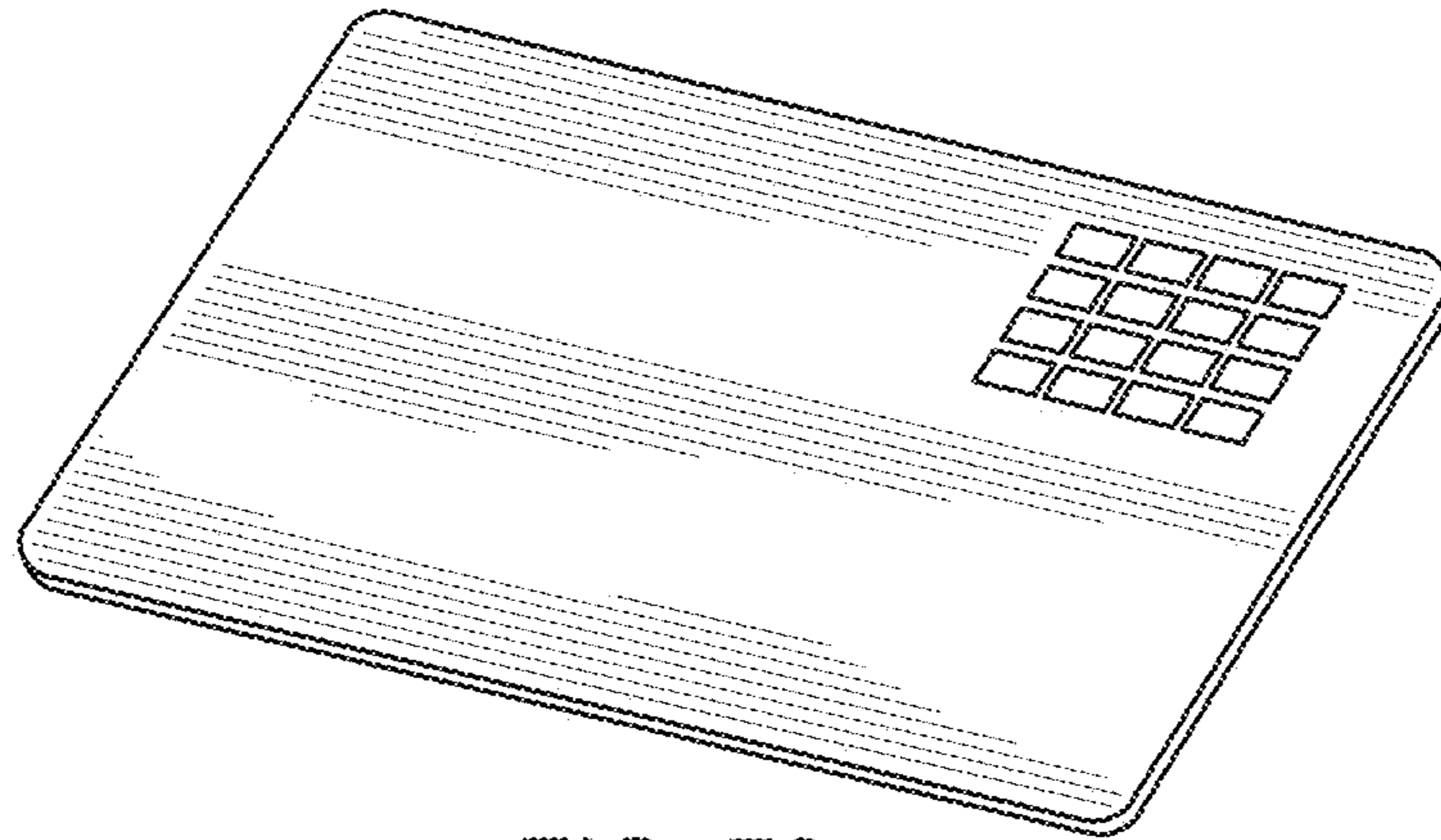

FIG. 78

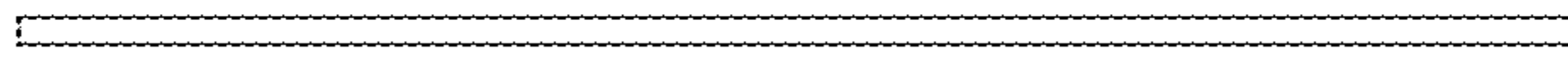

FIG. 81



FIG. 83

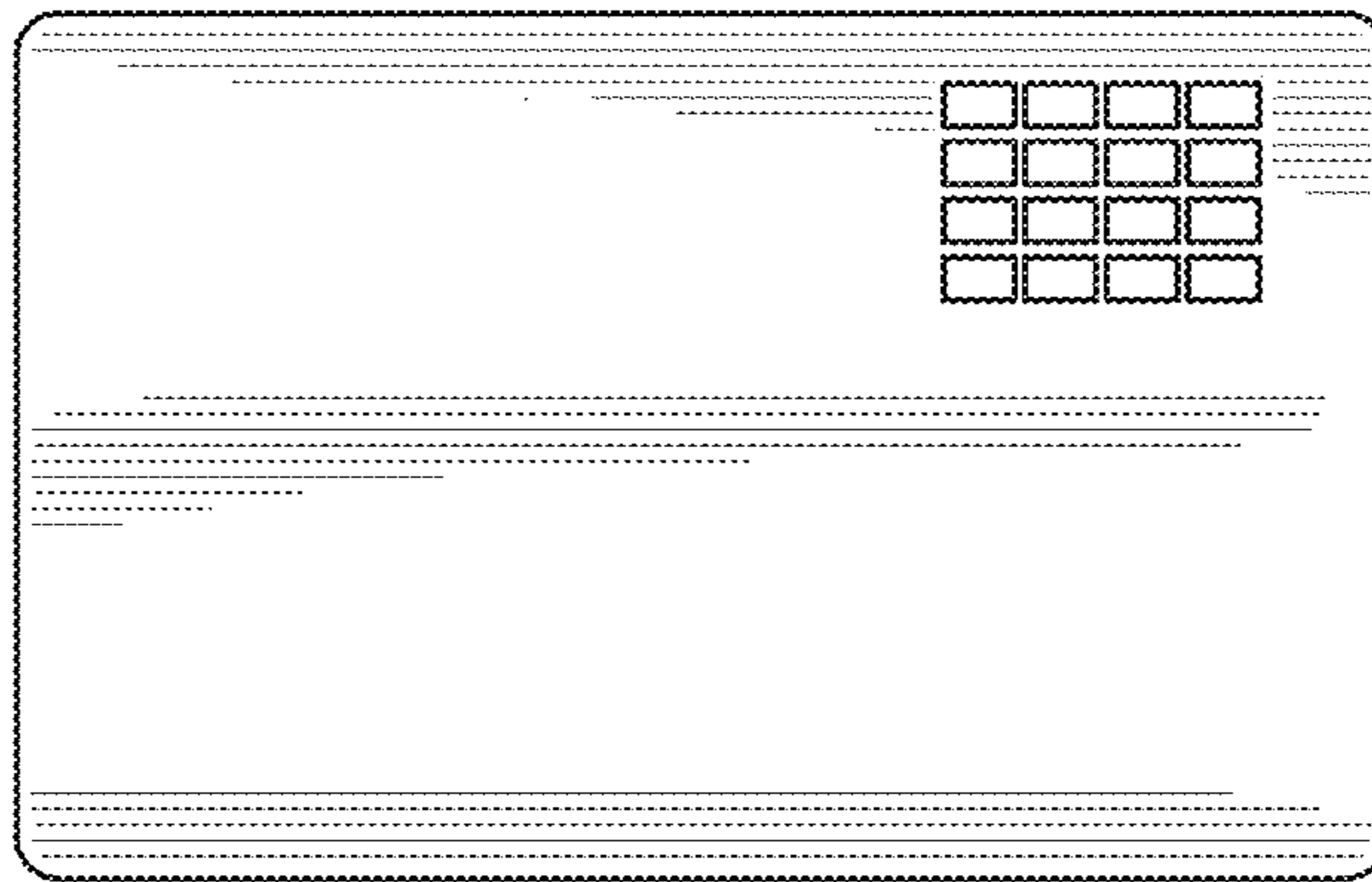

FIG. 79

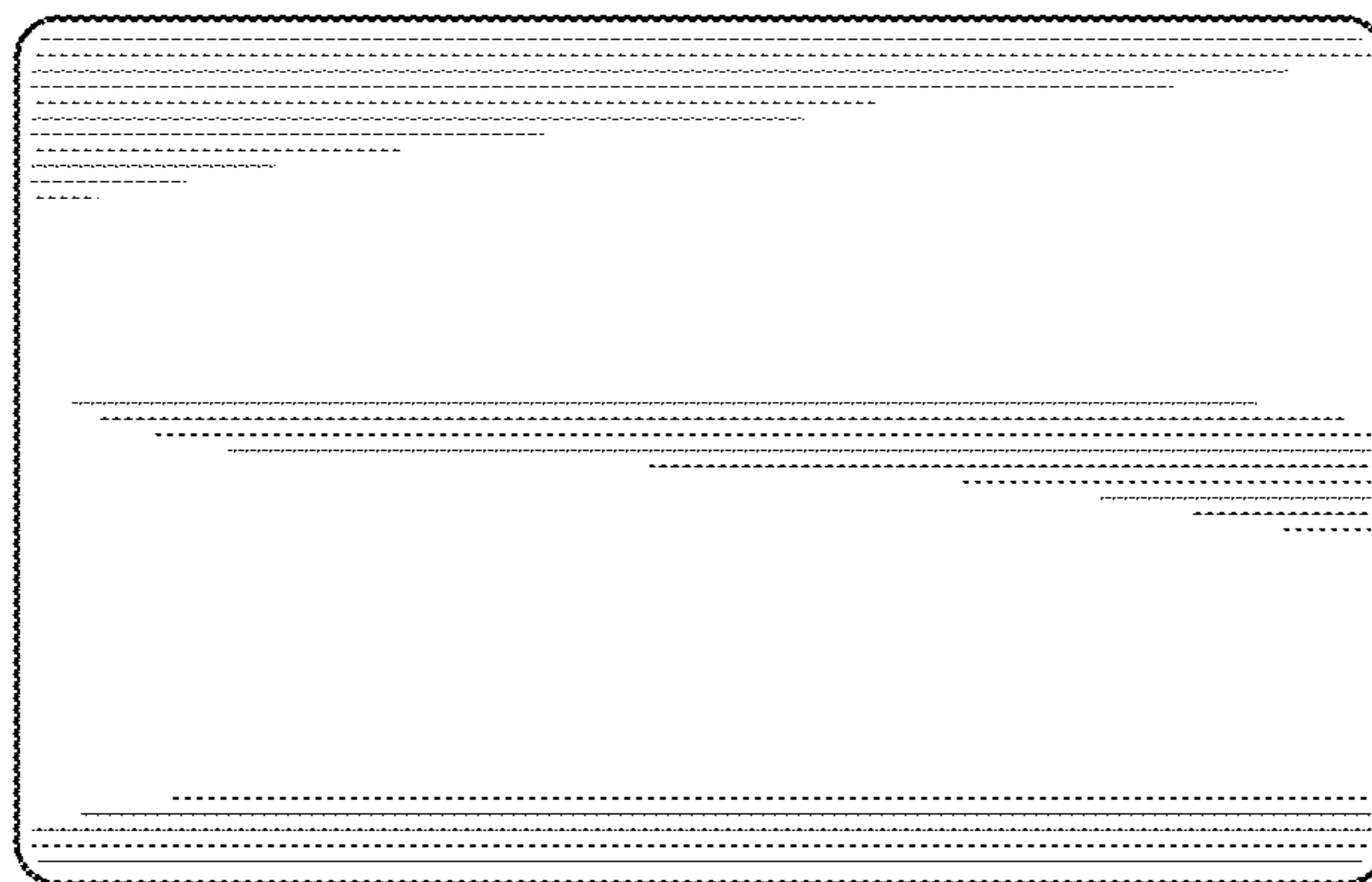

FIG. 80



FIG. 84

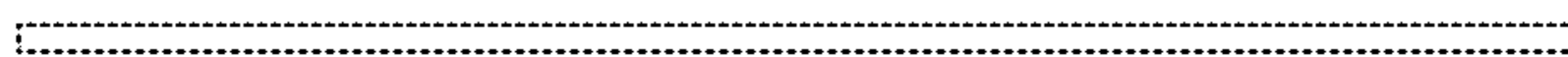

FIG. 82



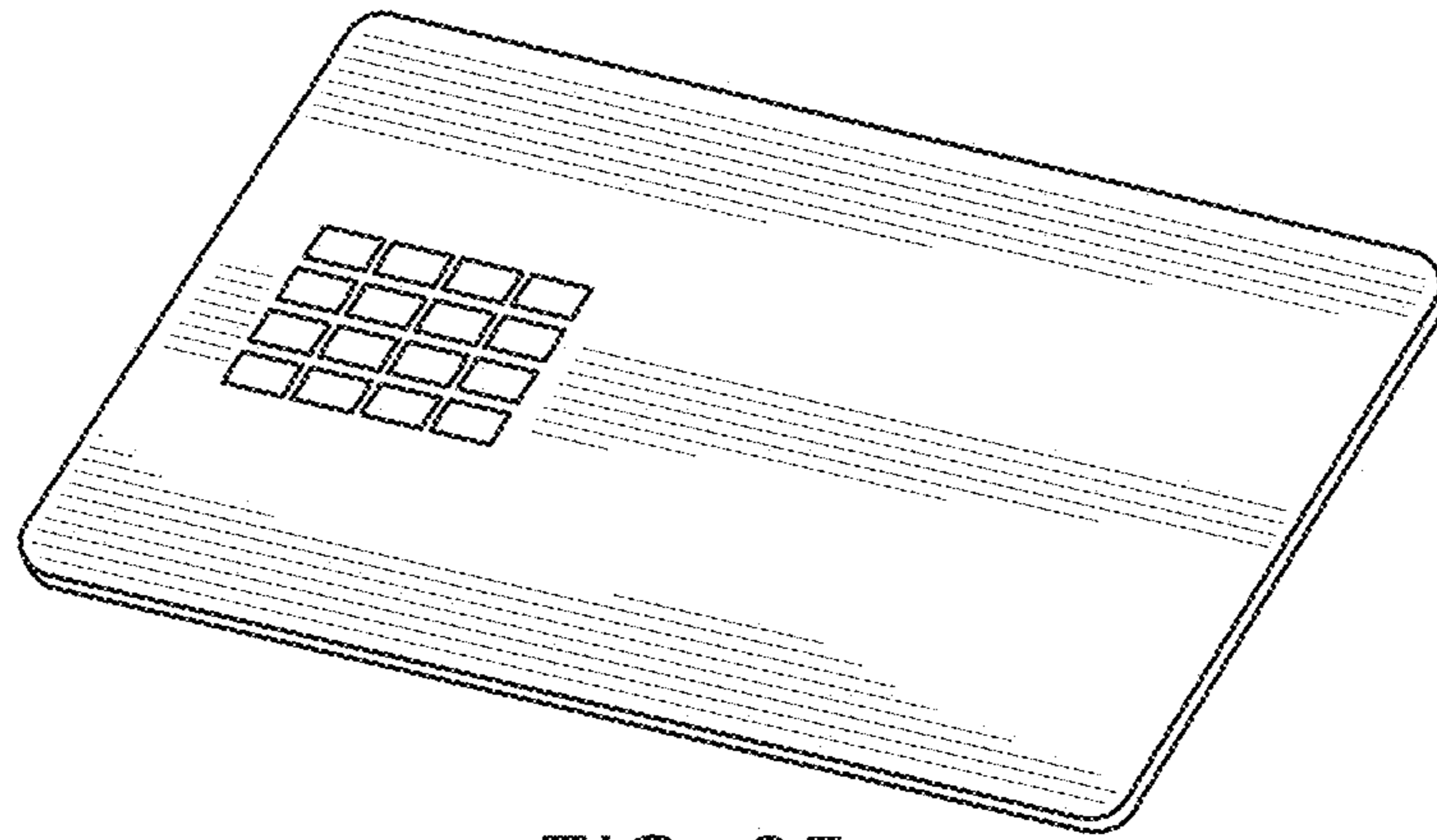

FIG. 85

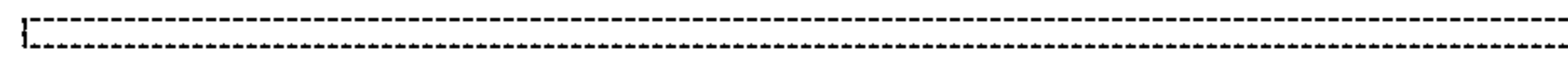

FIG. 88

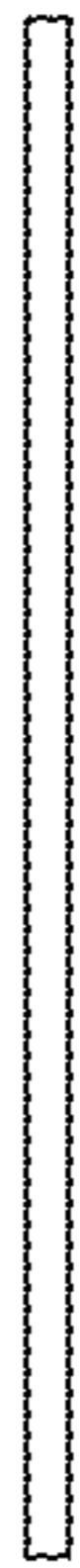

FIG. 90

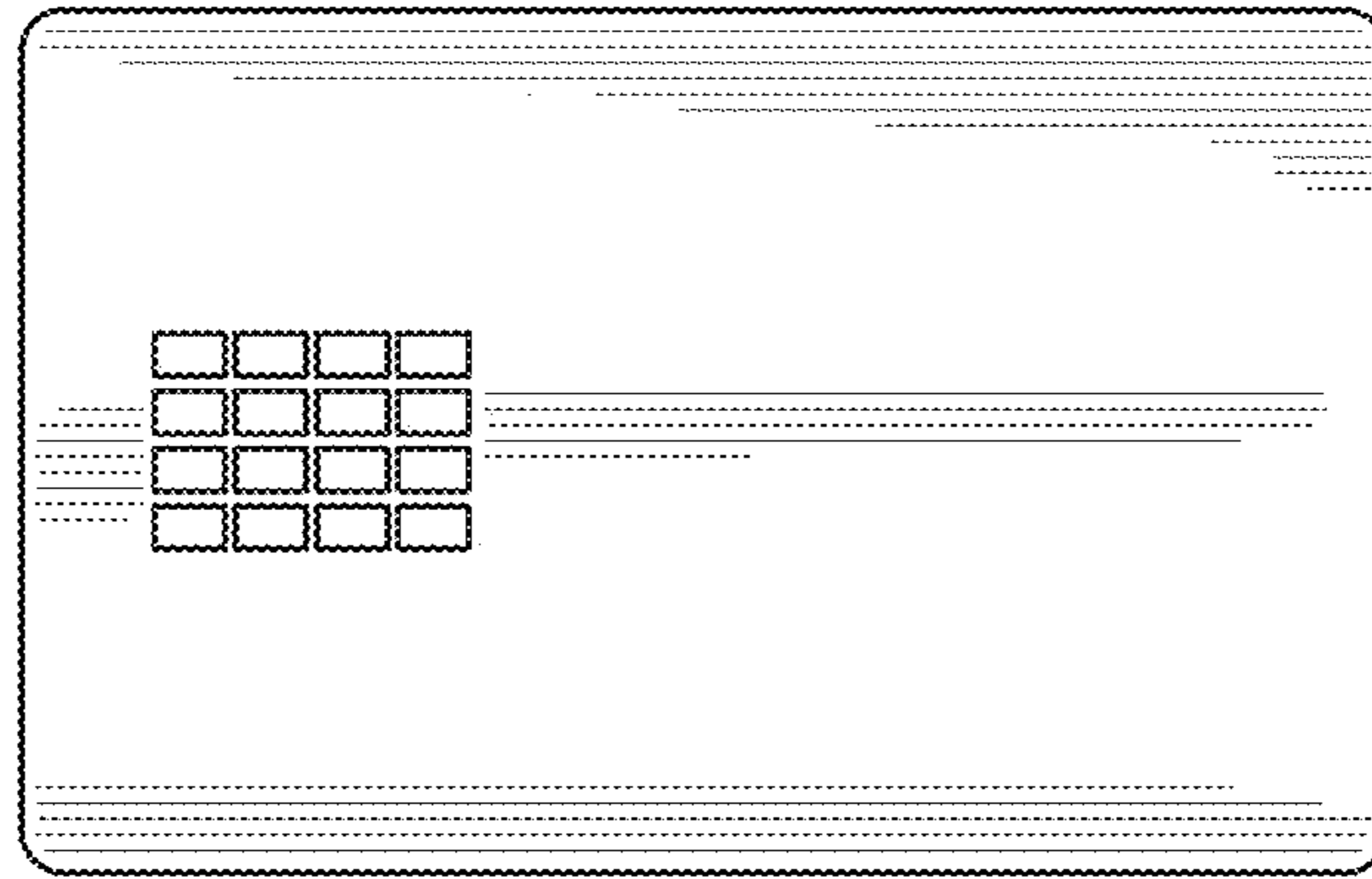

FIG. 86

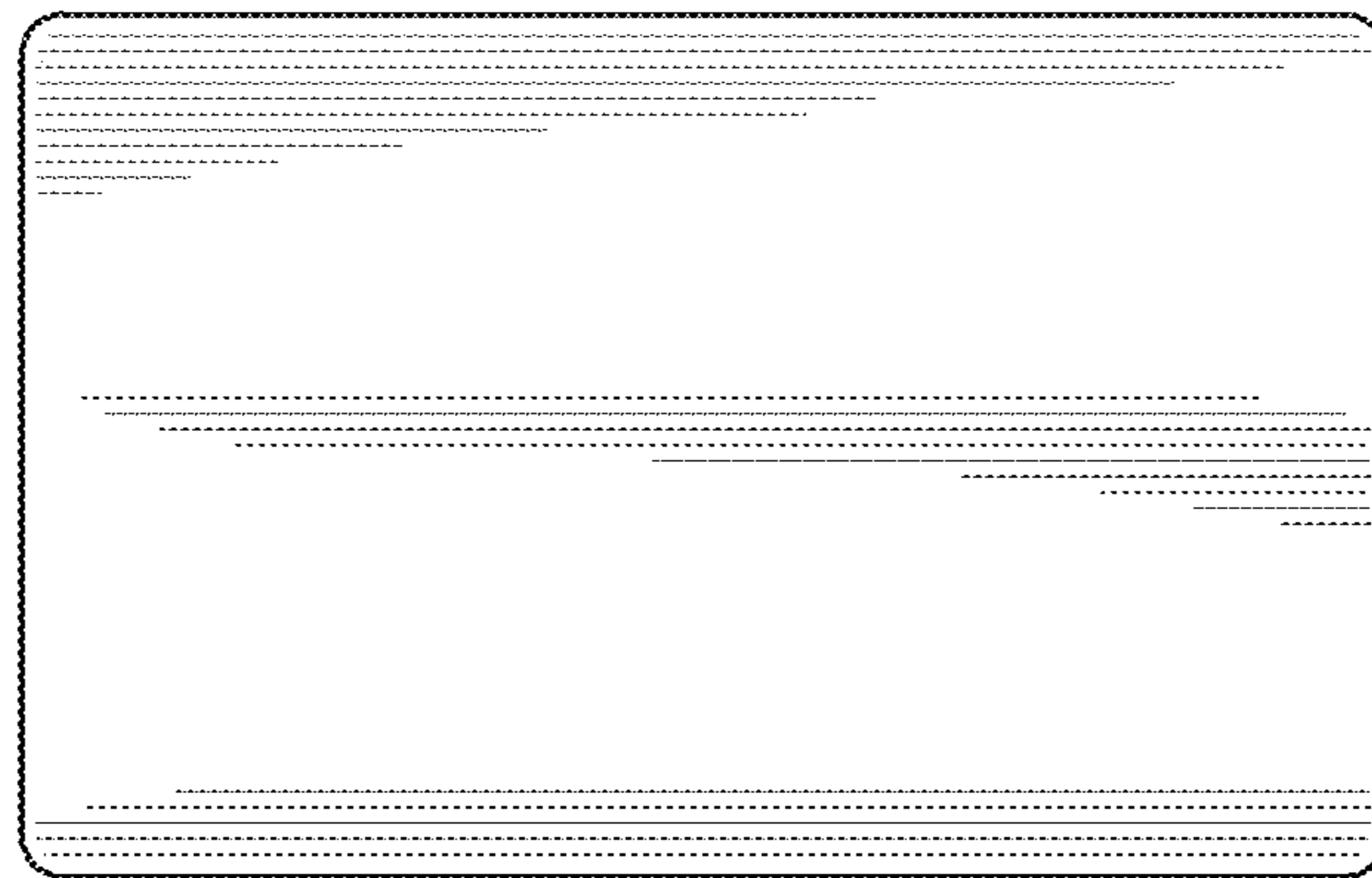

FIG. 87

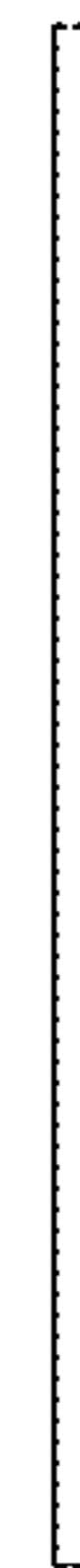

FIG. 91

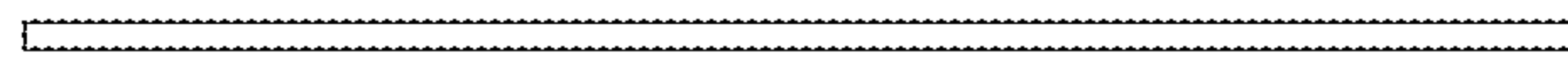

FIG. 89

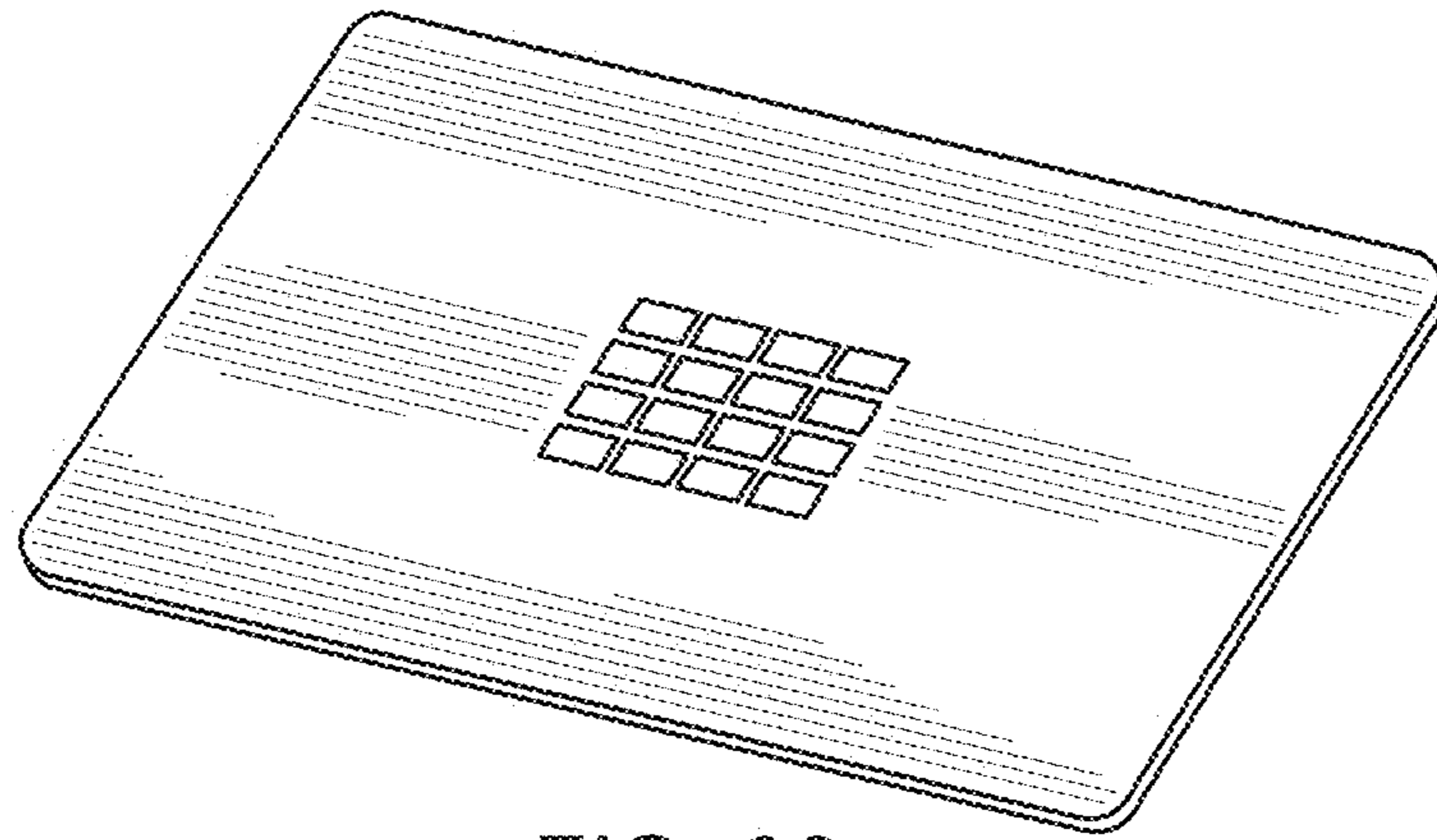

FIG. 92

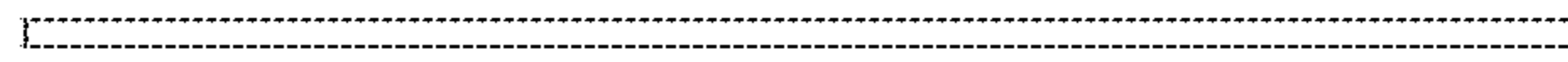

FIG. 95

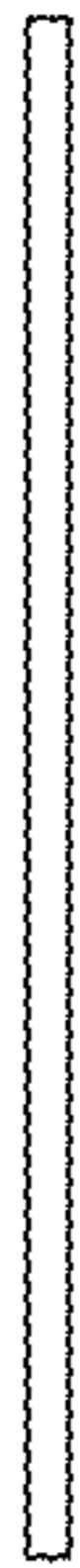

FIG. 97

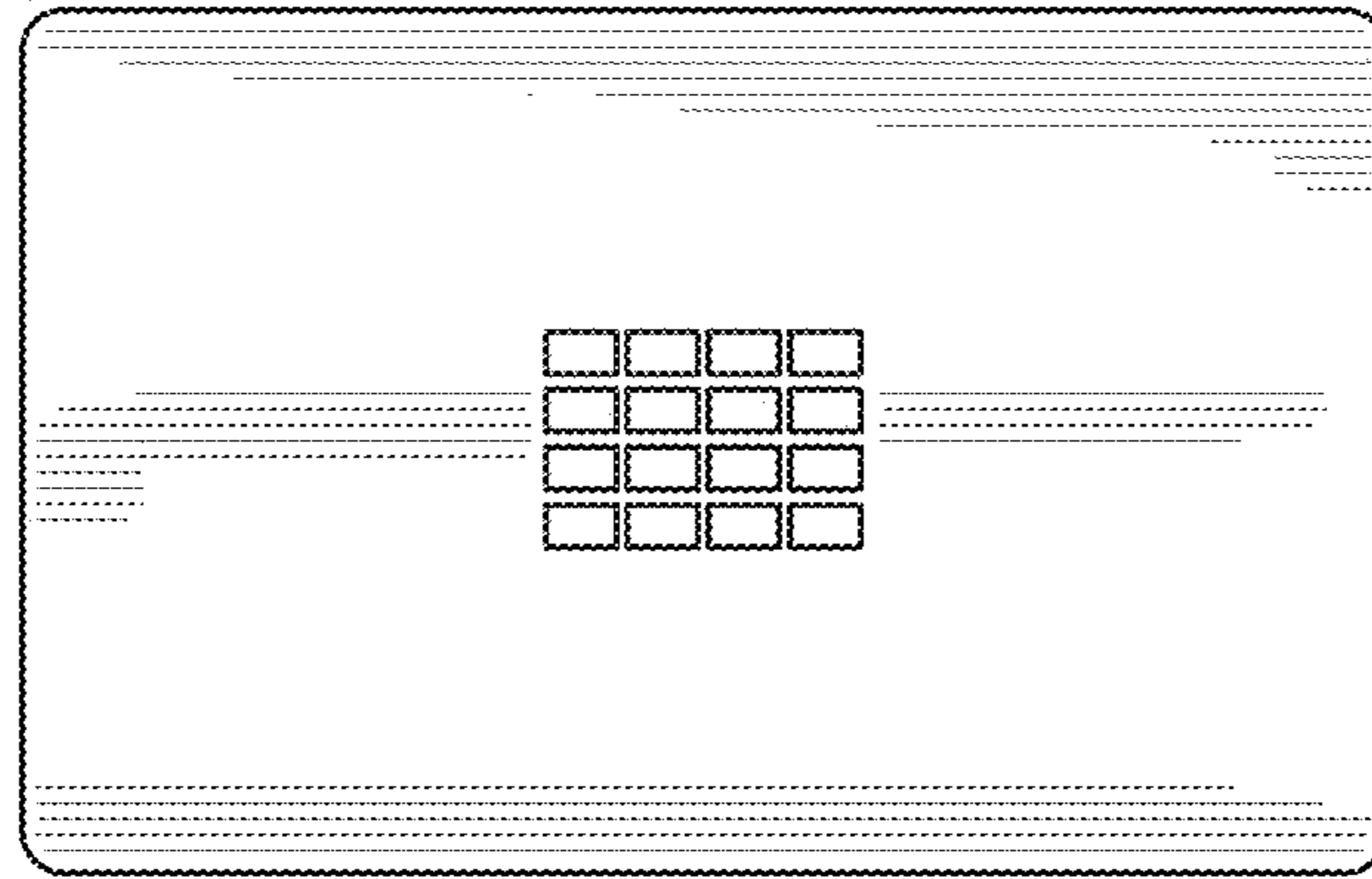

FIG. 93

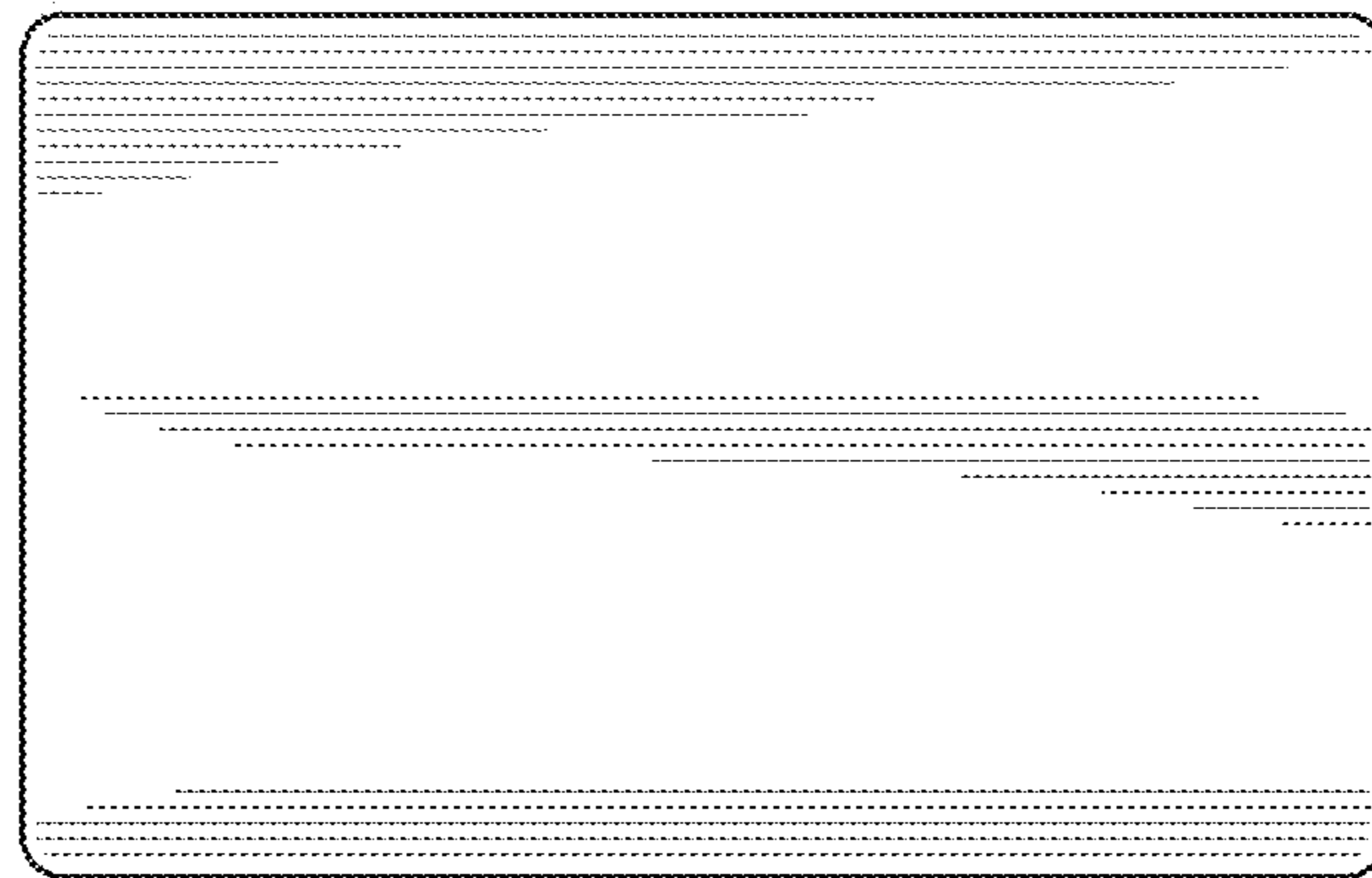

FIG. 94

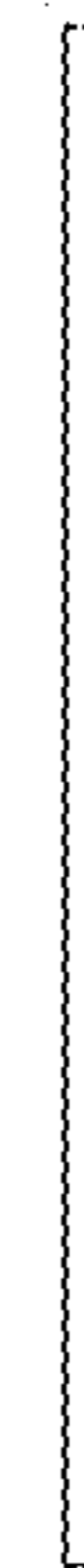

FIG. 98

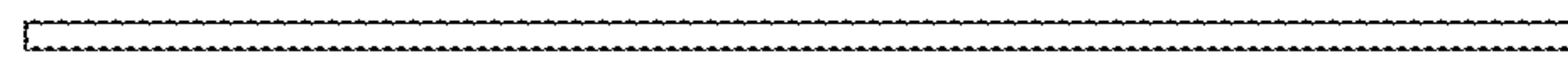

FIG. 96

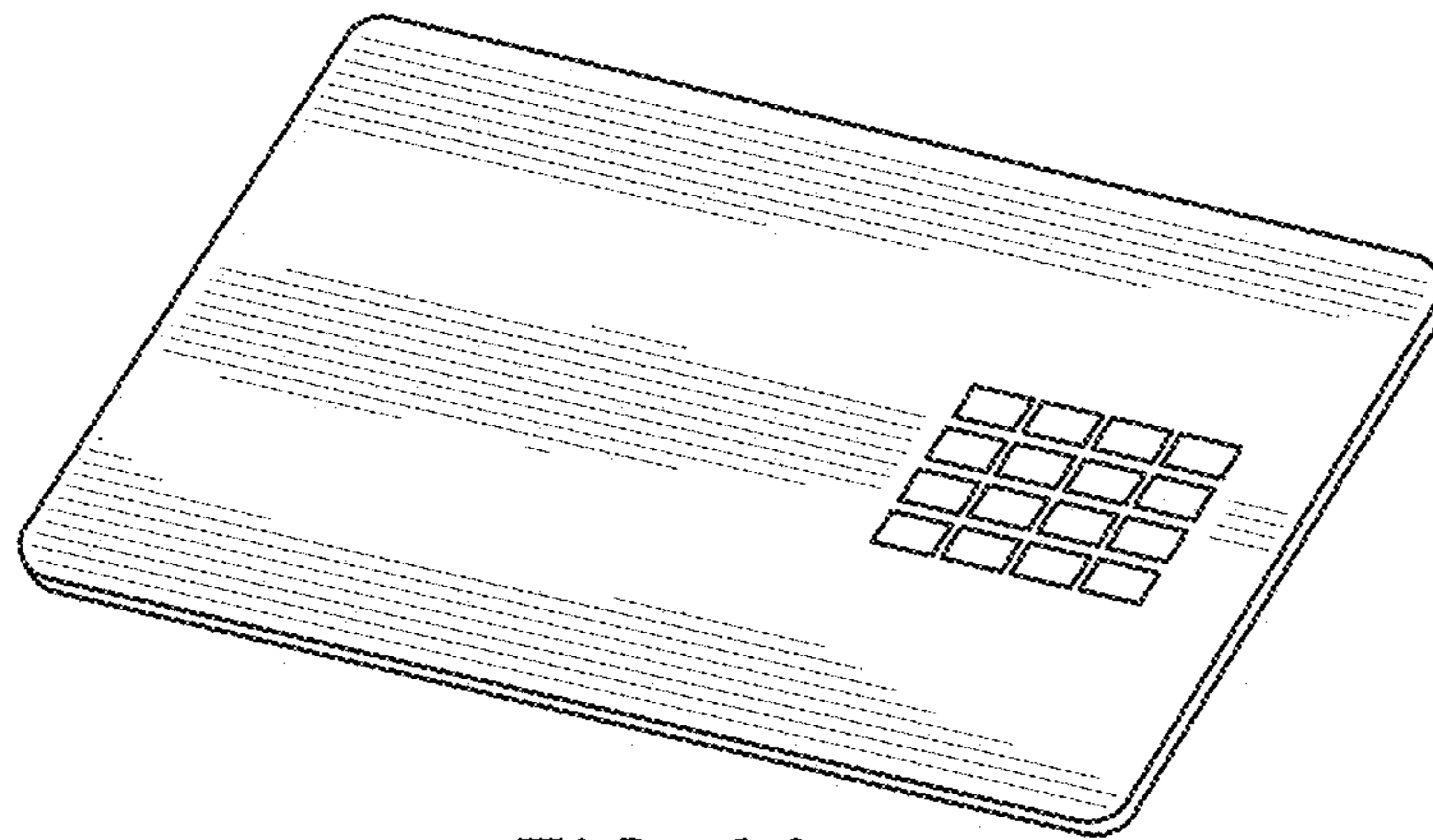

FIG. 99

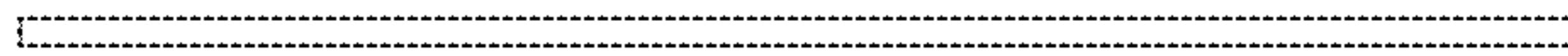

FIG. 102



FIG. 104

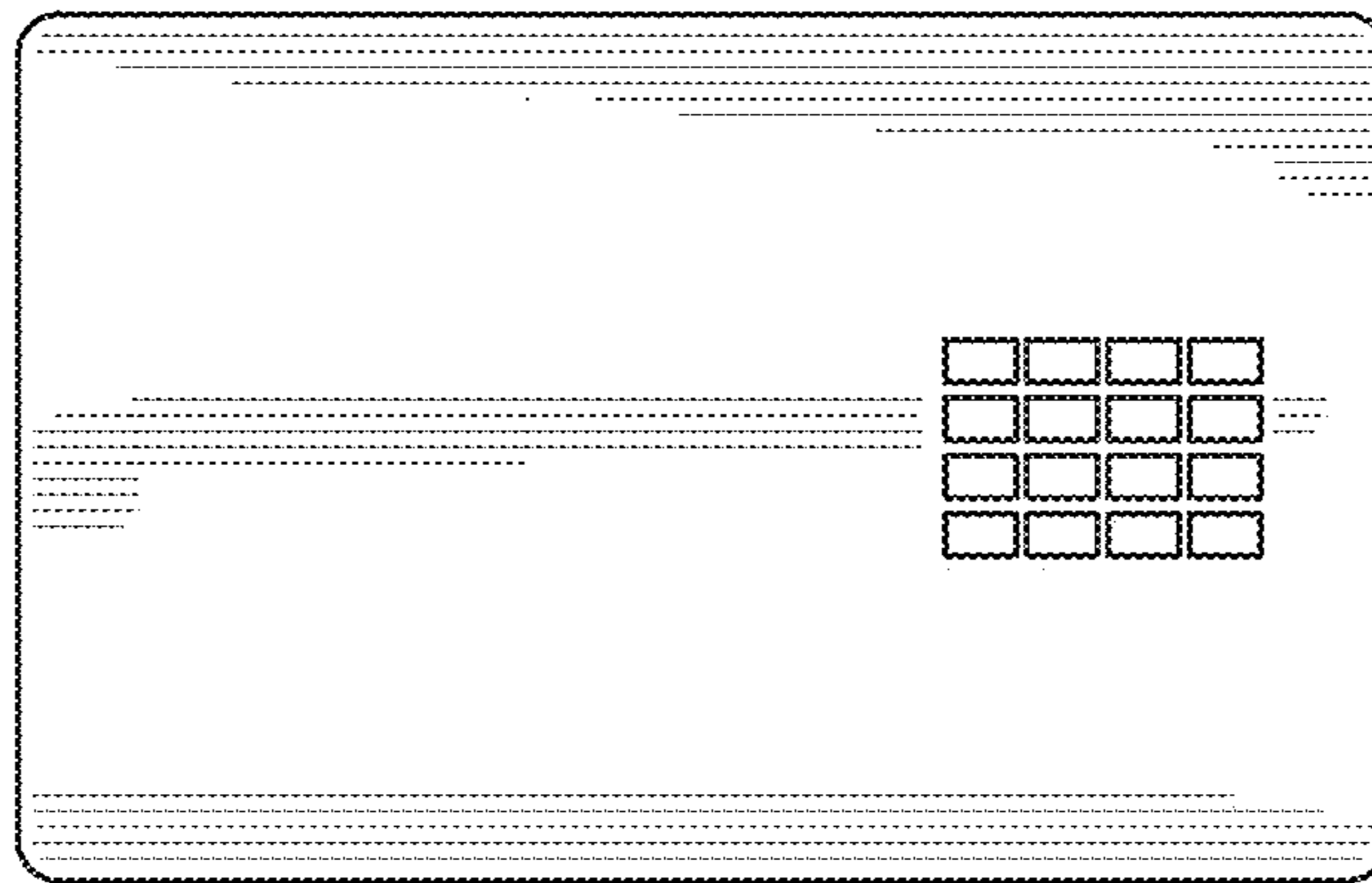

FIG. 100

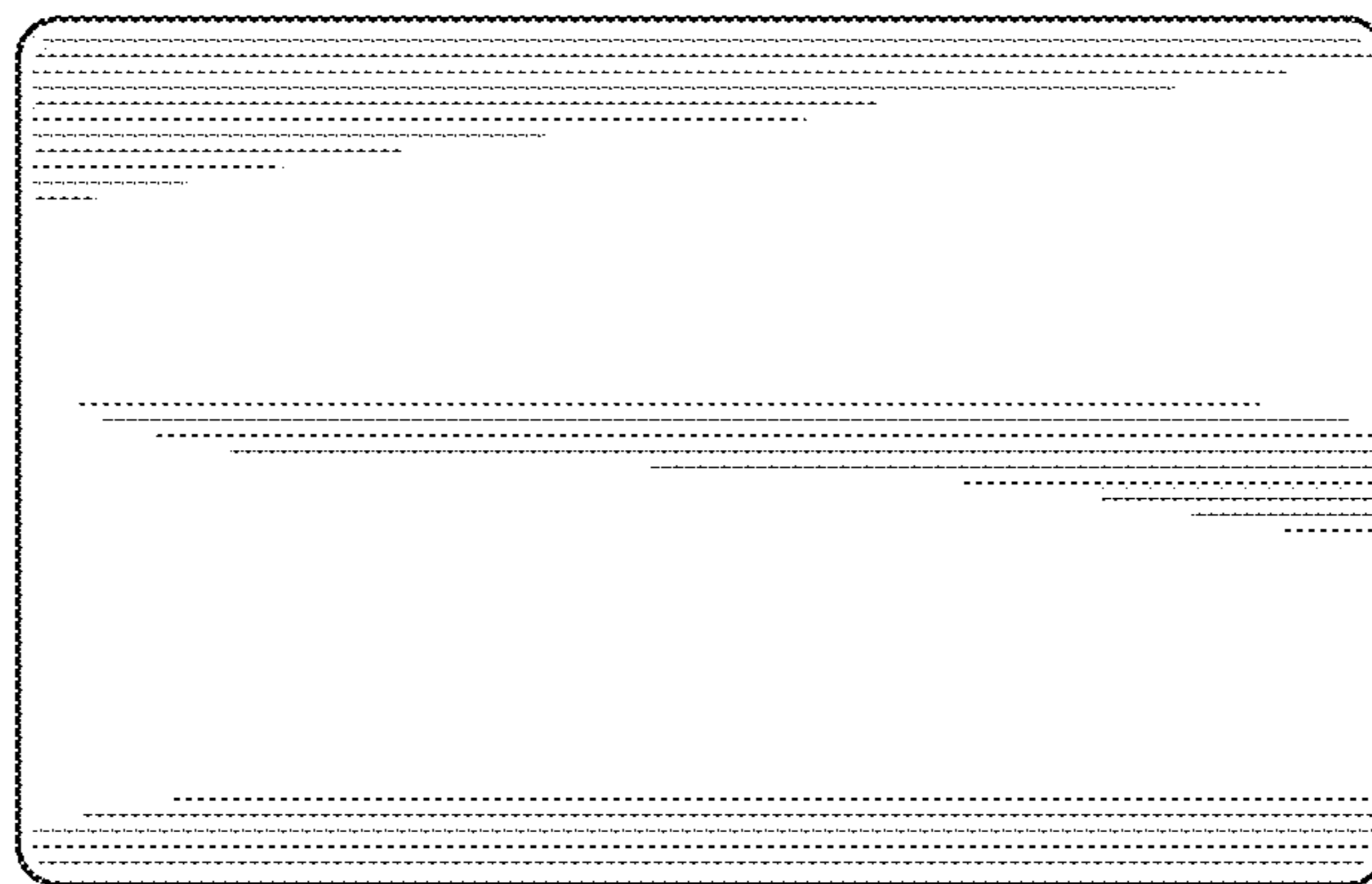

FIG. 101



FIG. 105

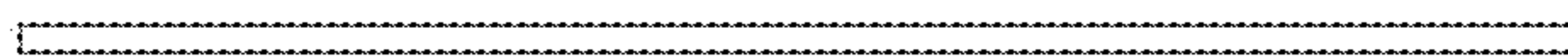

FIG. 103

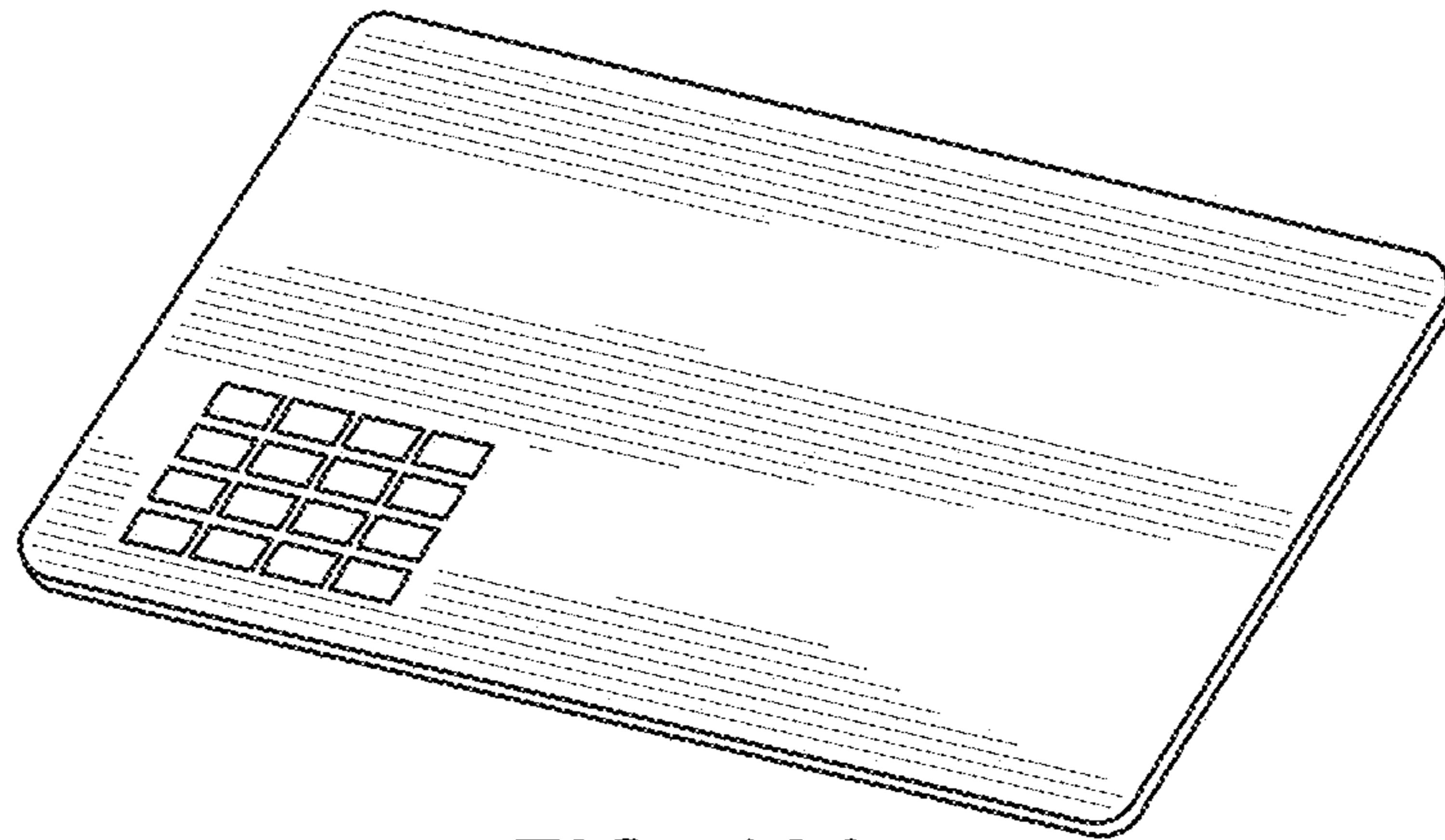

FIG. 106

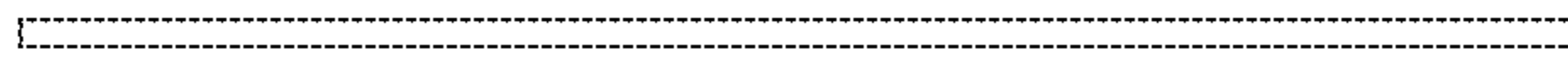

FIG. 109

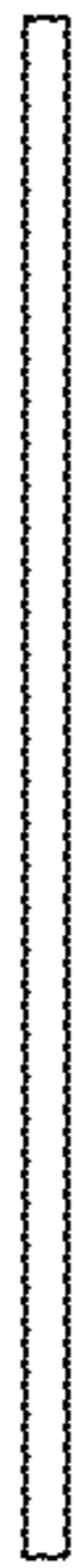

FIG. 111

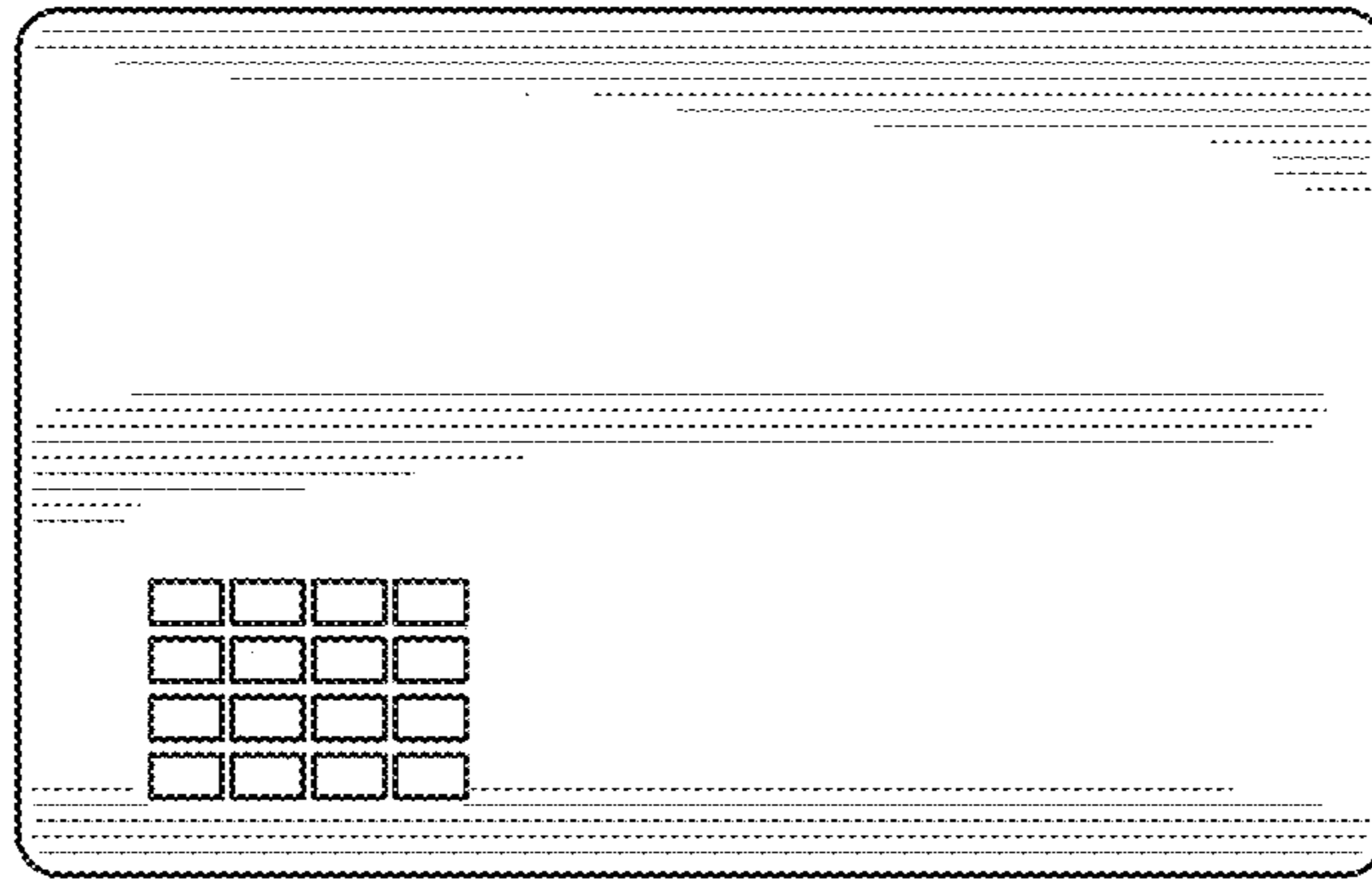

FIG. 107

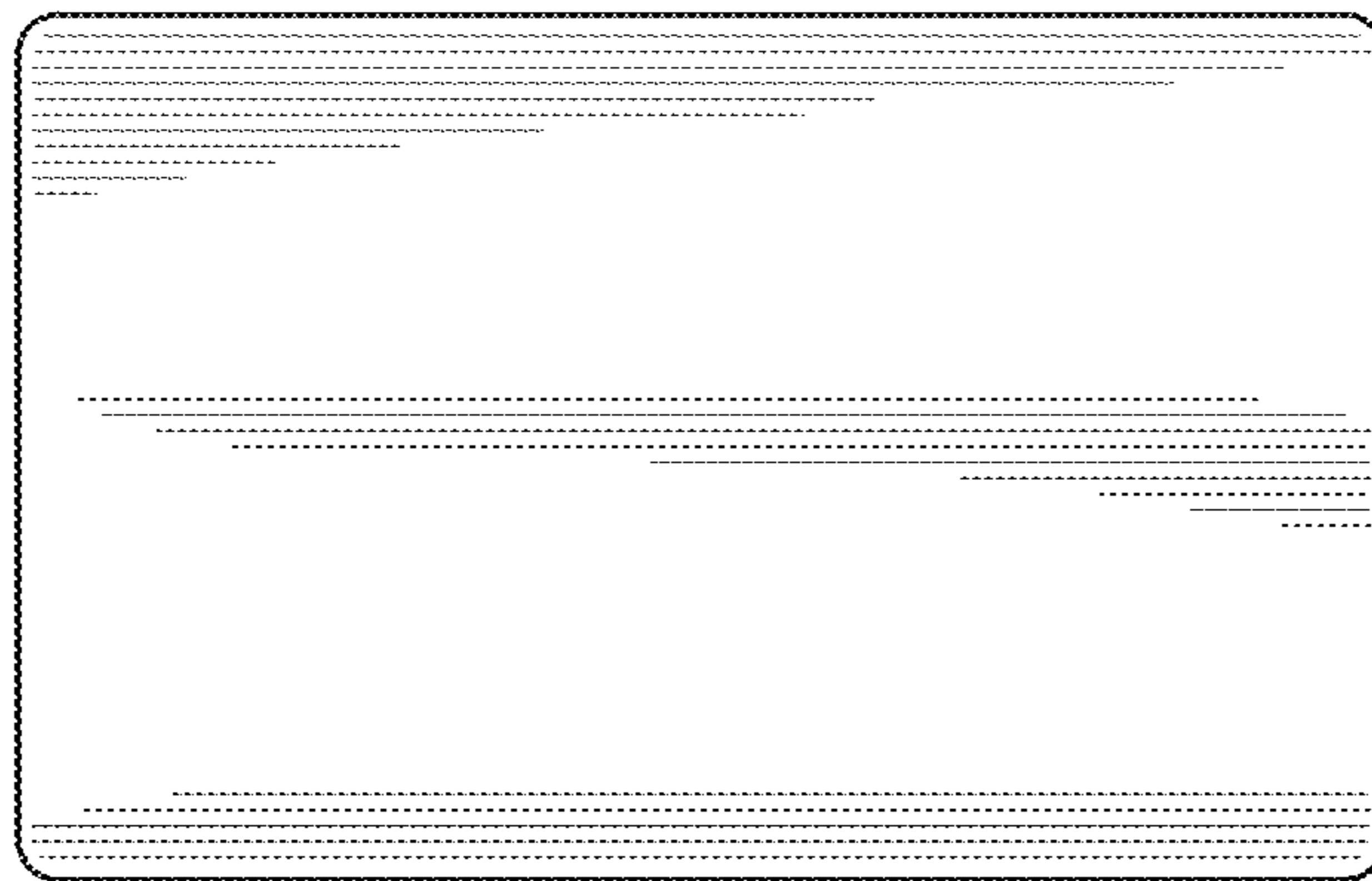

FIG. 108

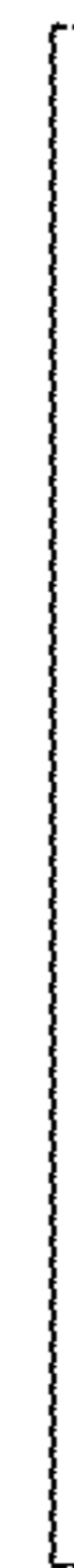

FIG. 112

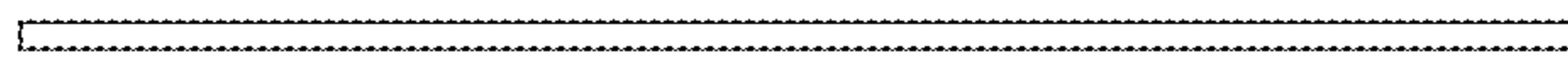

FIG. 110

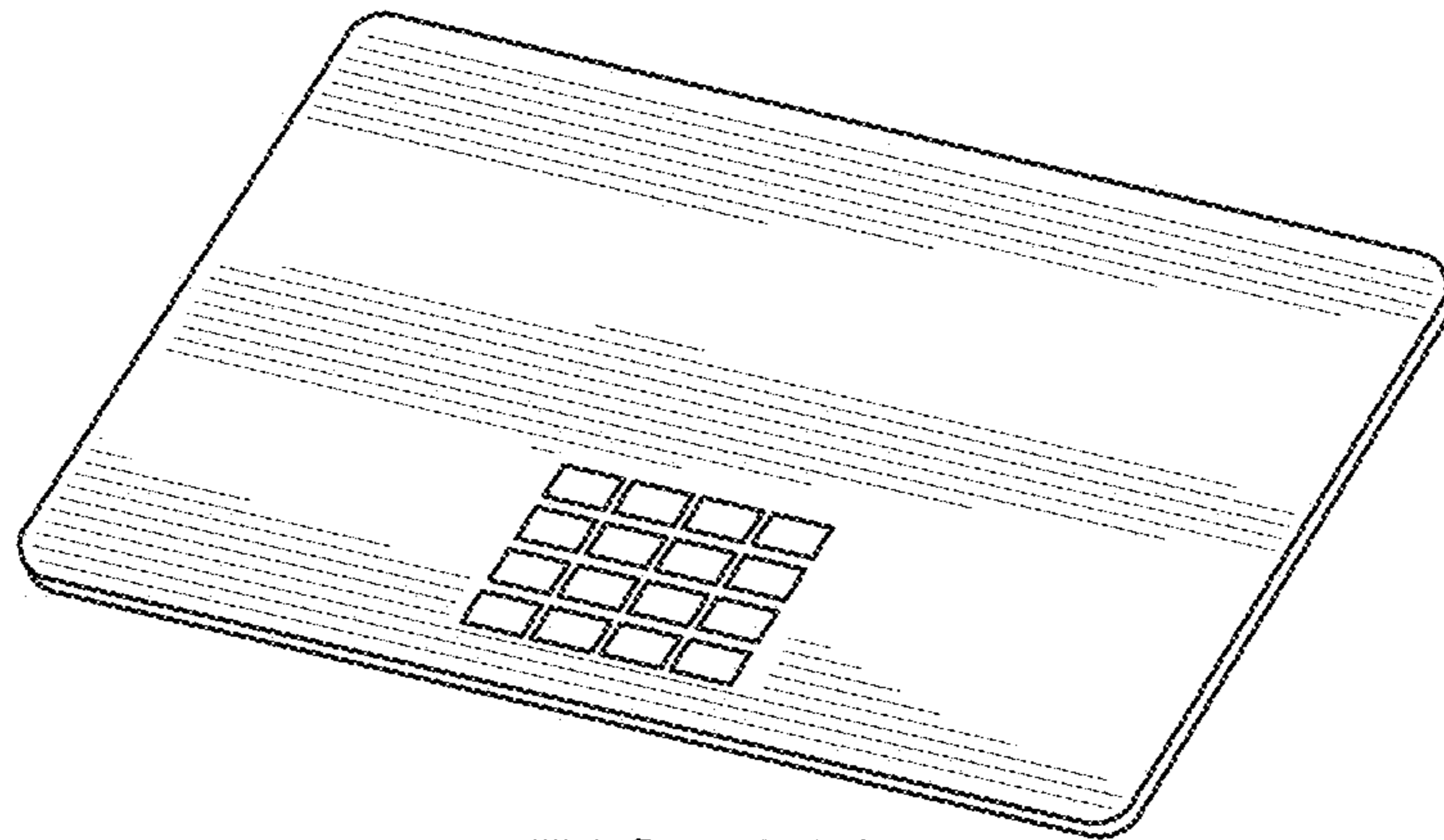

FIG. 113

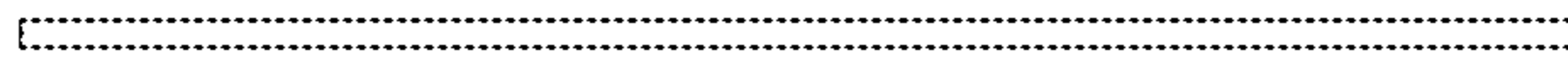

FIG. 116



FIG. 118

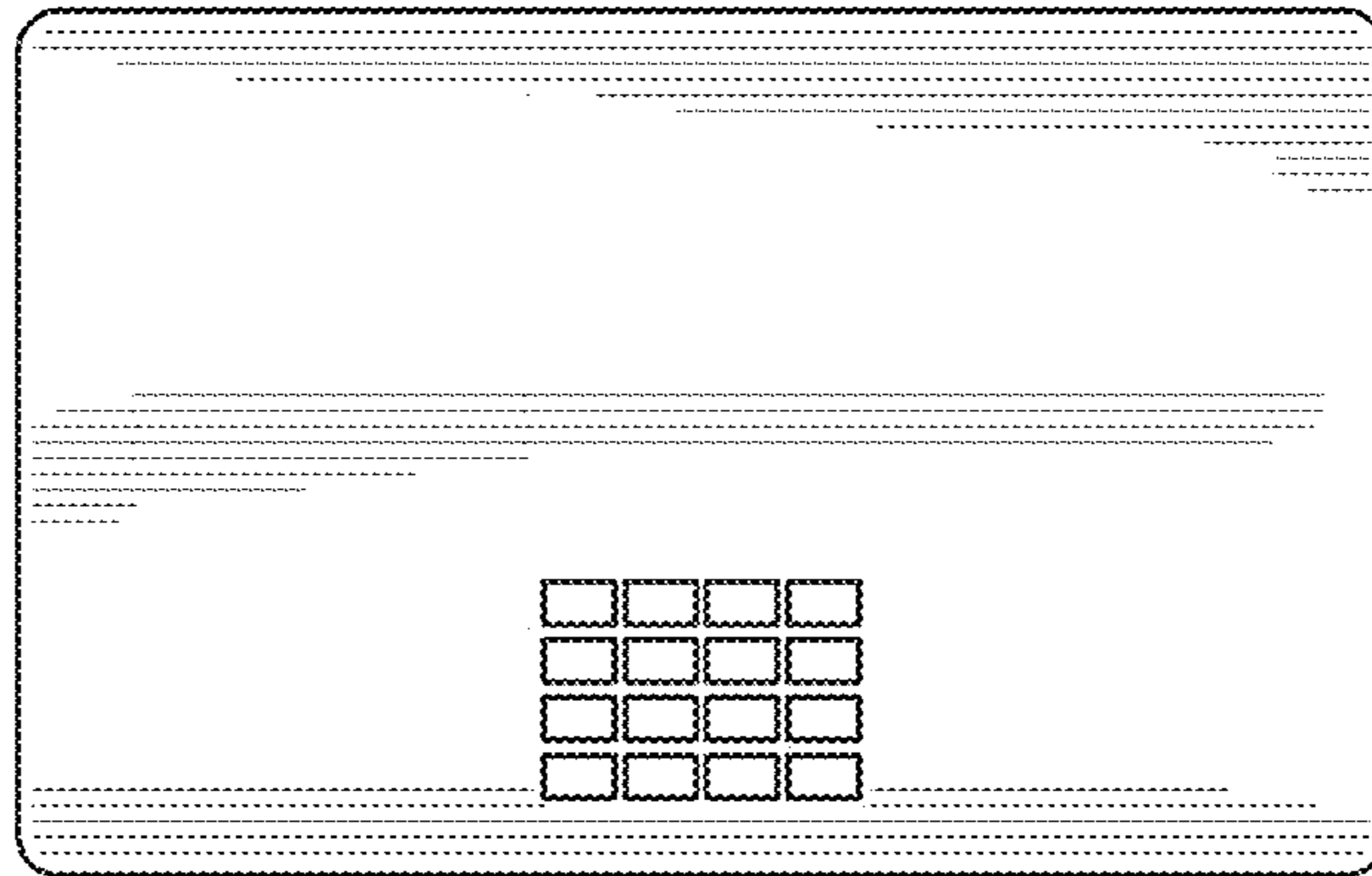

FIG. 114

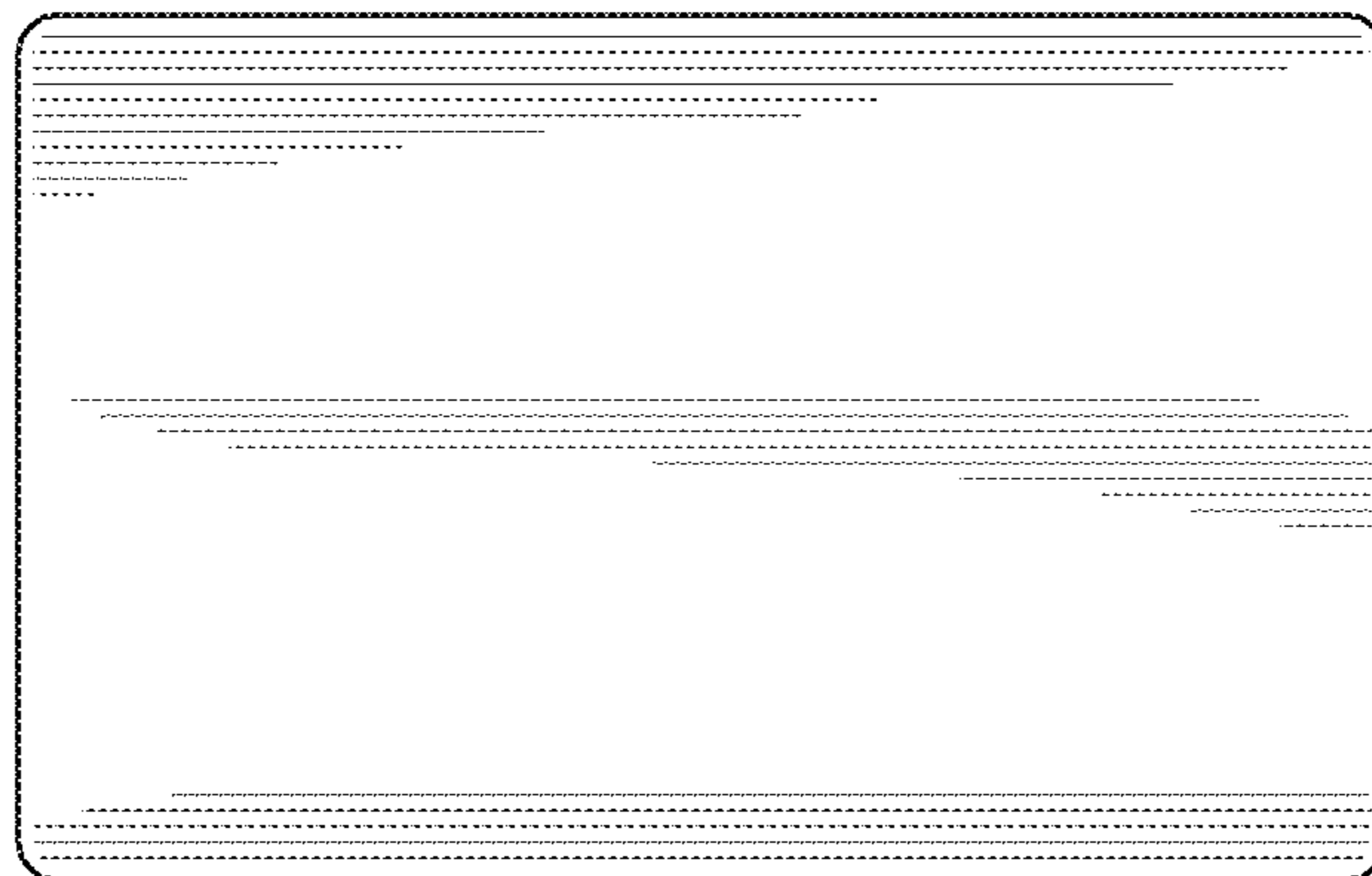

FIG. 115

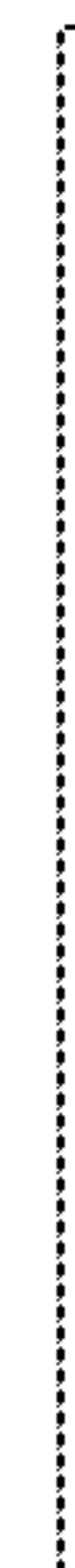

FIG. 119

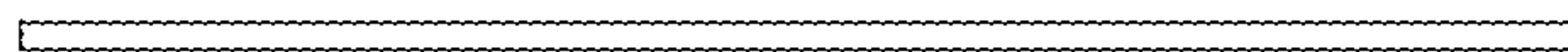

FIG. 117

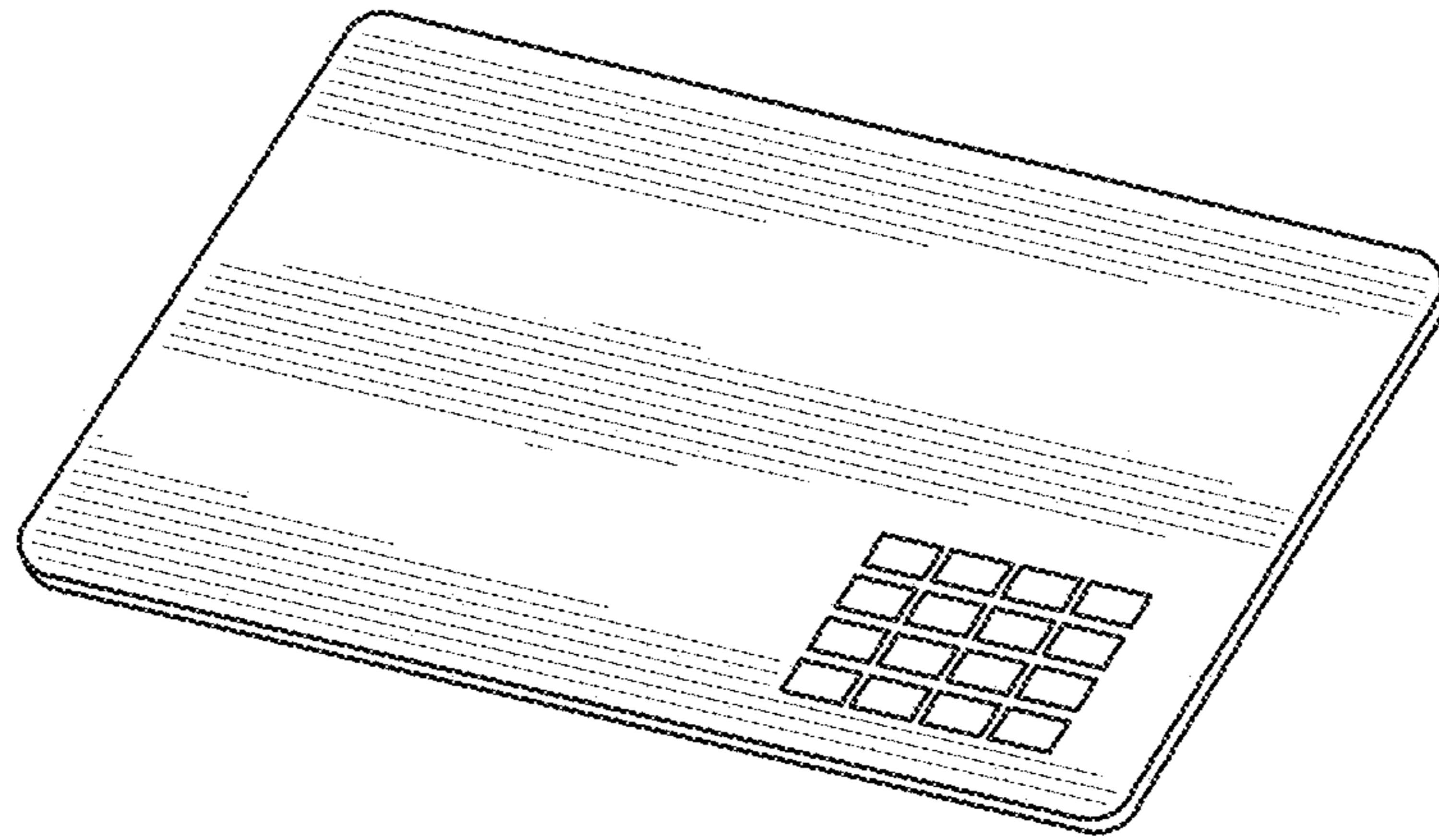

FIG. 120

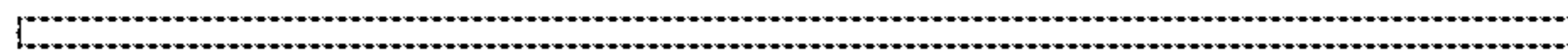

FIG. 123

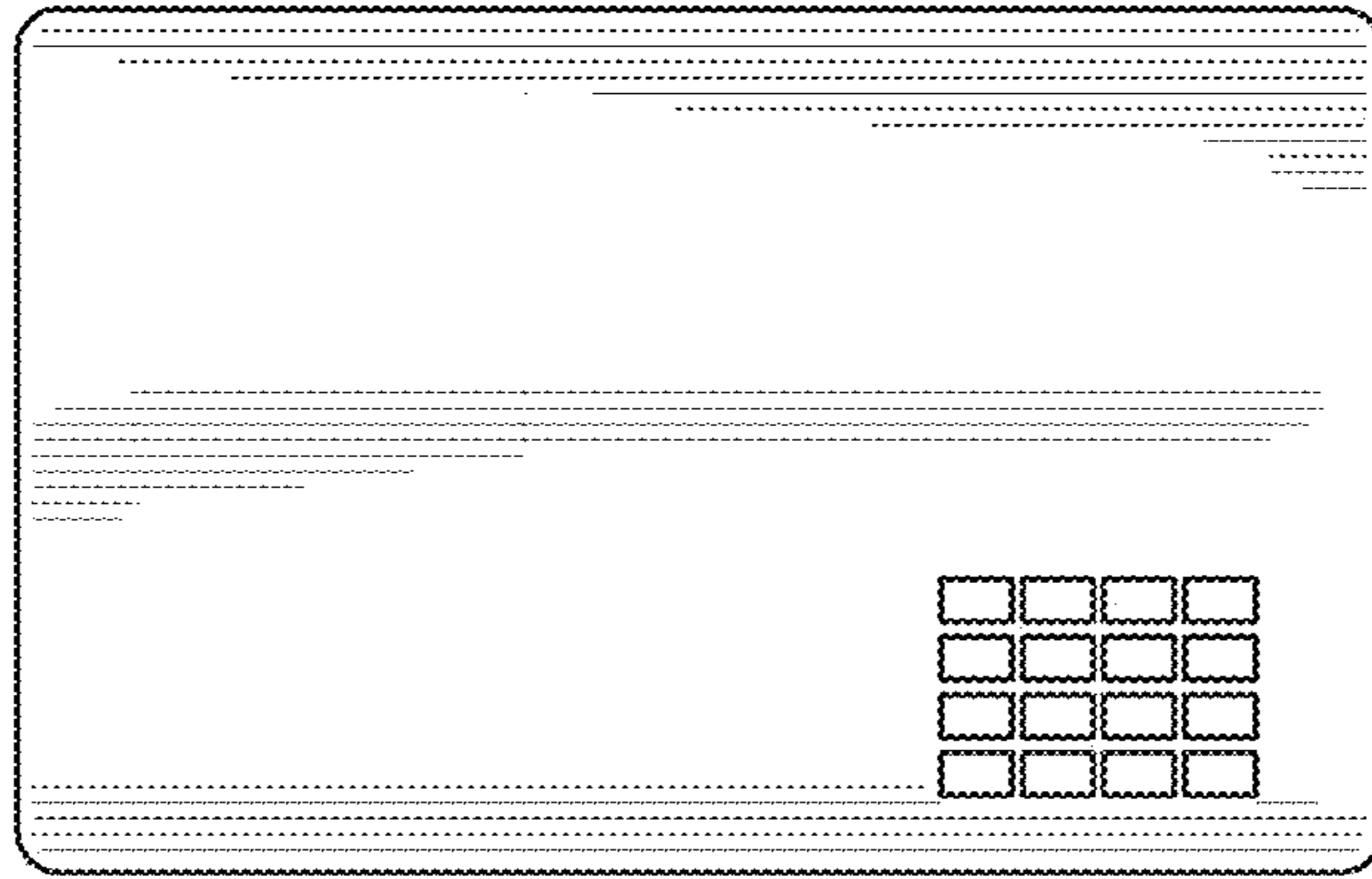
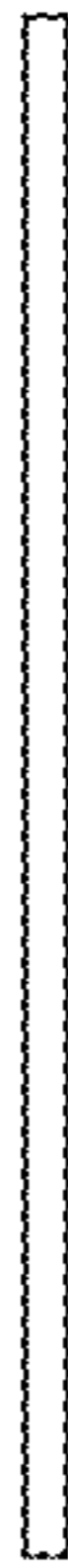

FIG. 121

FIG. 125

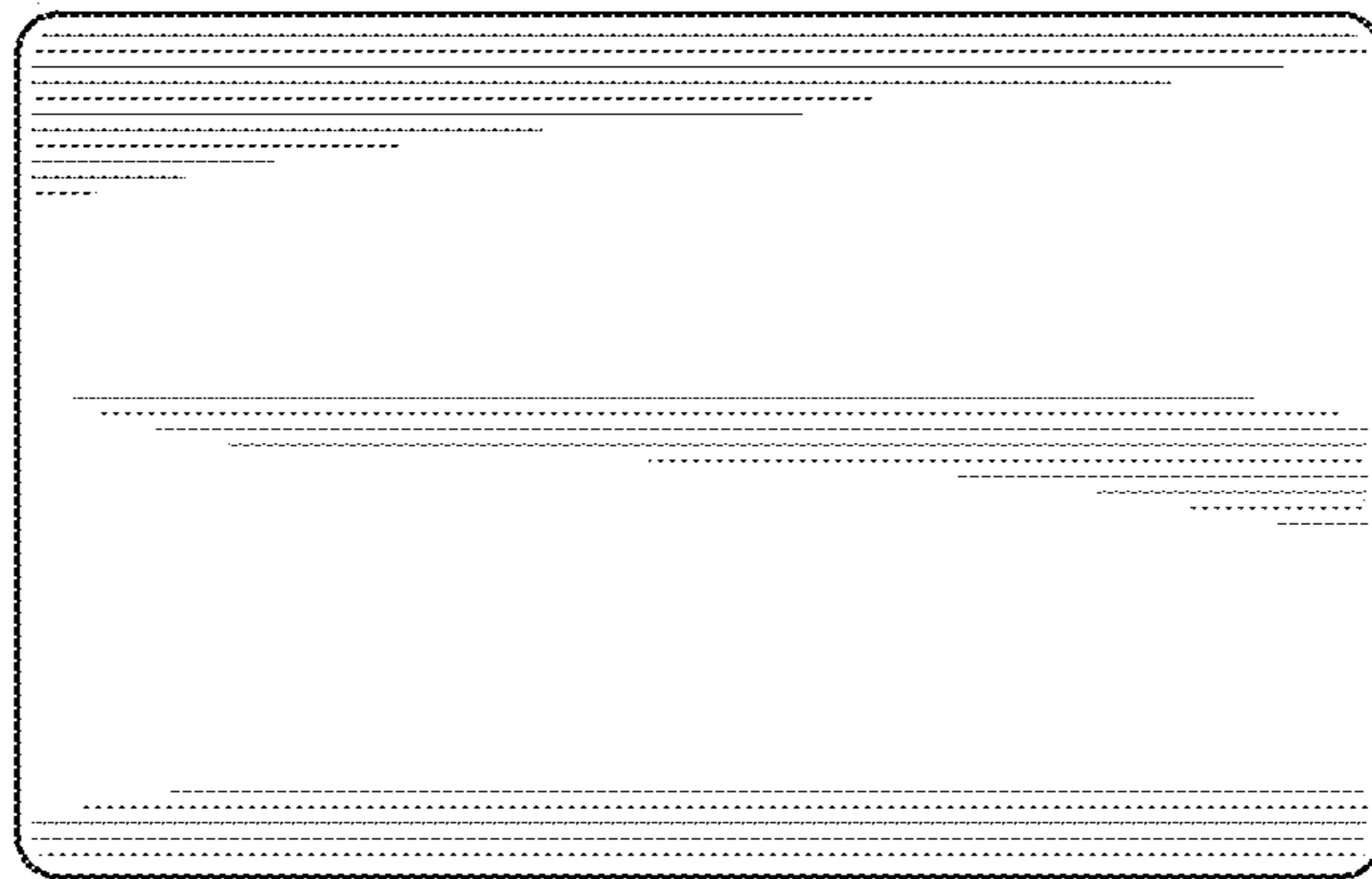

FIG. 122

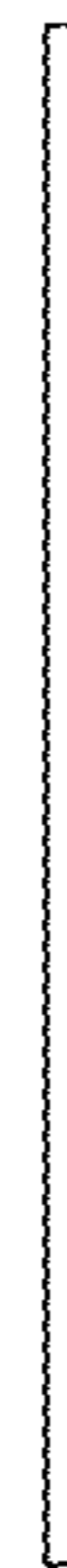

FIG. 126

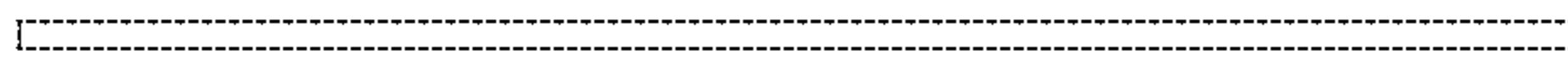

FIG. 124

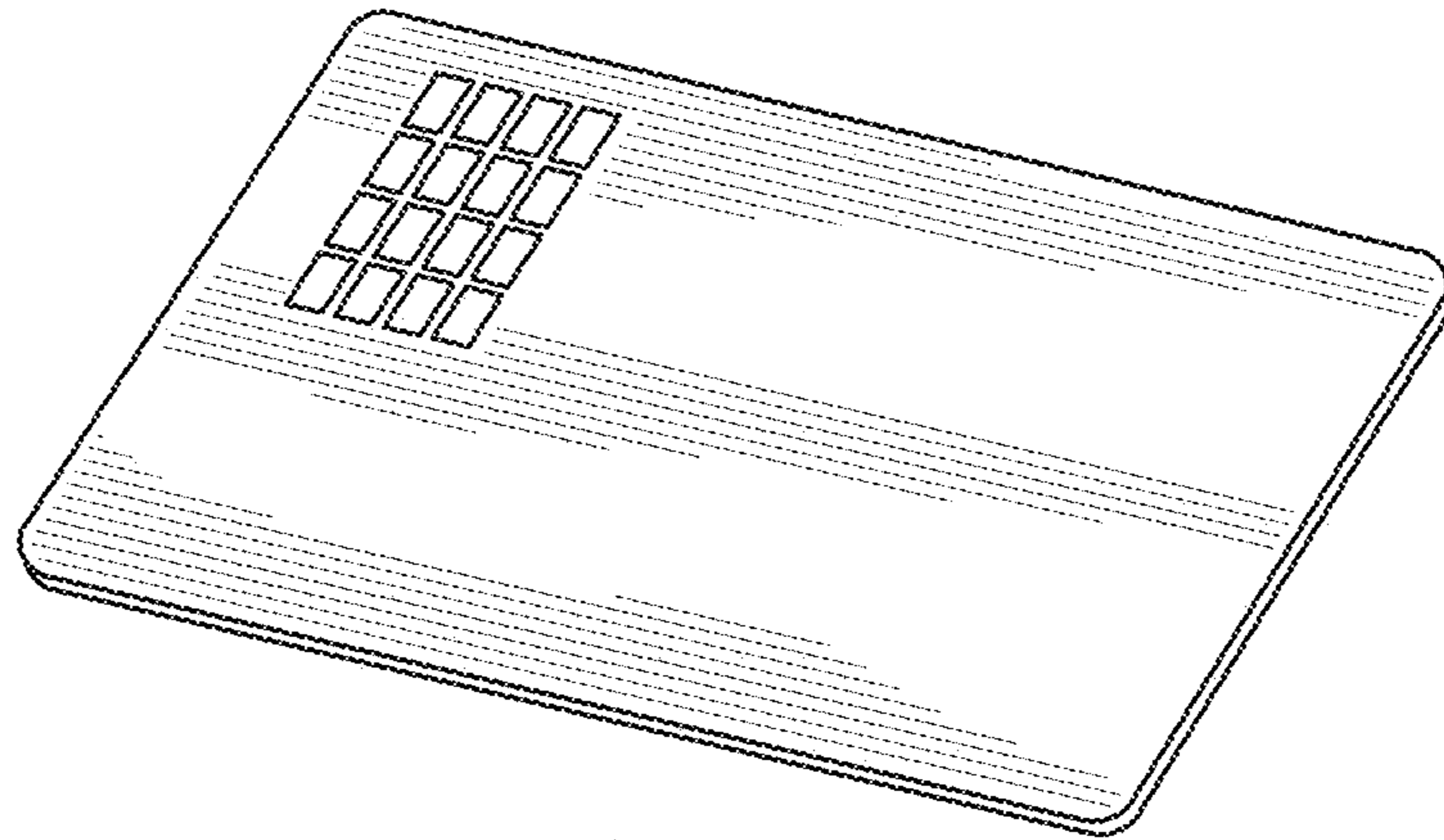

FIG. 127

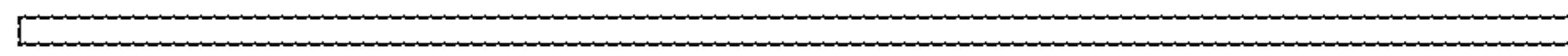

FIG. 130



FIG. 132

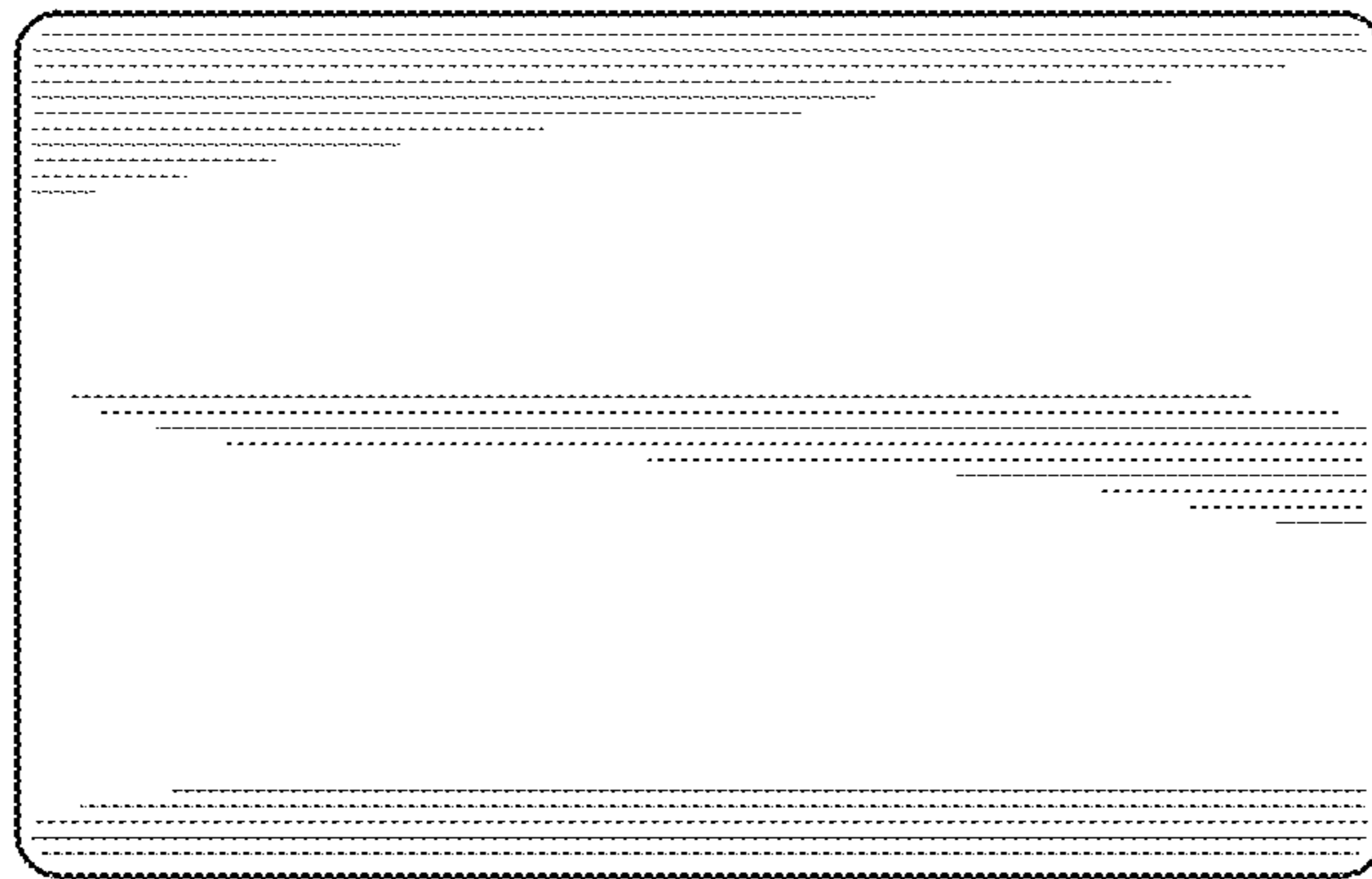

FIG. 128

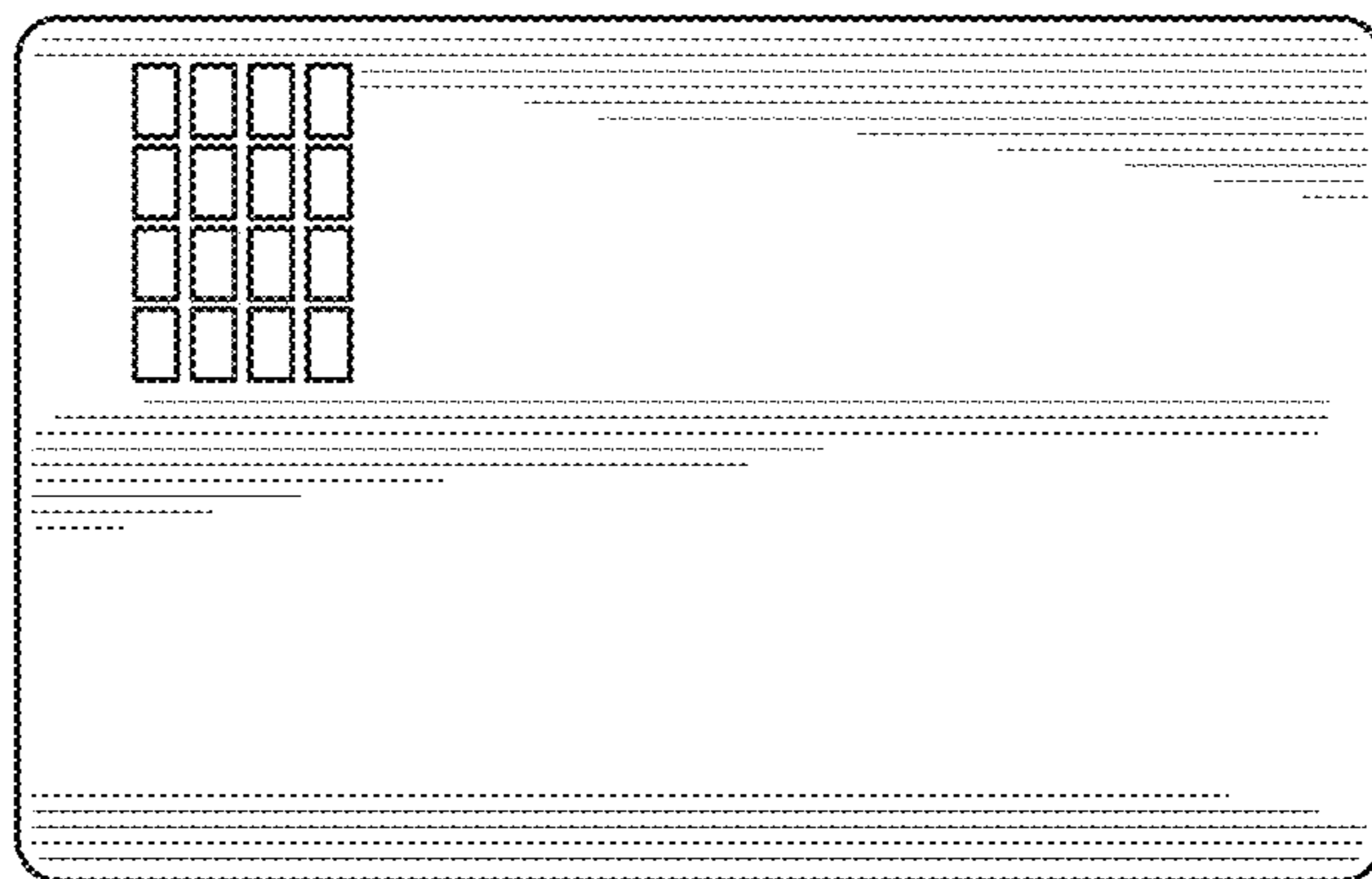

FIG. 129

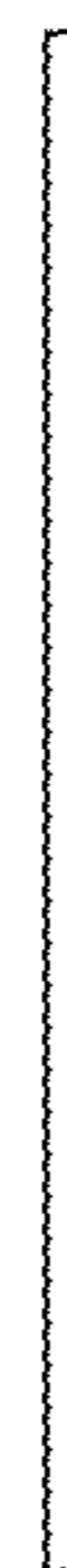

FIG. 133

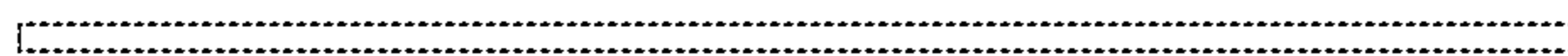

FIG. 131

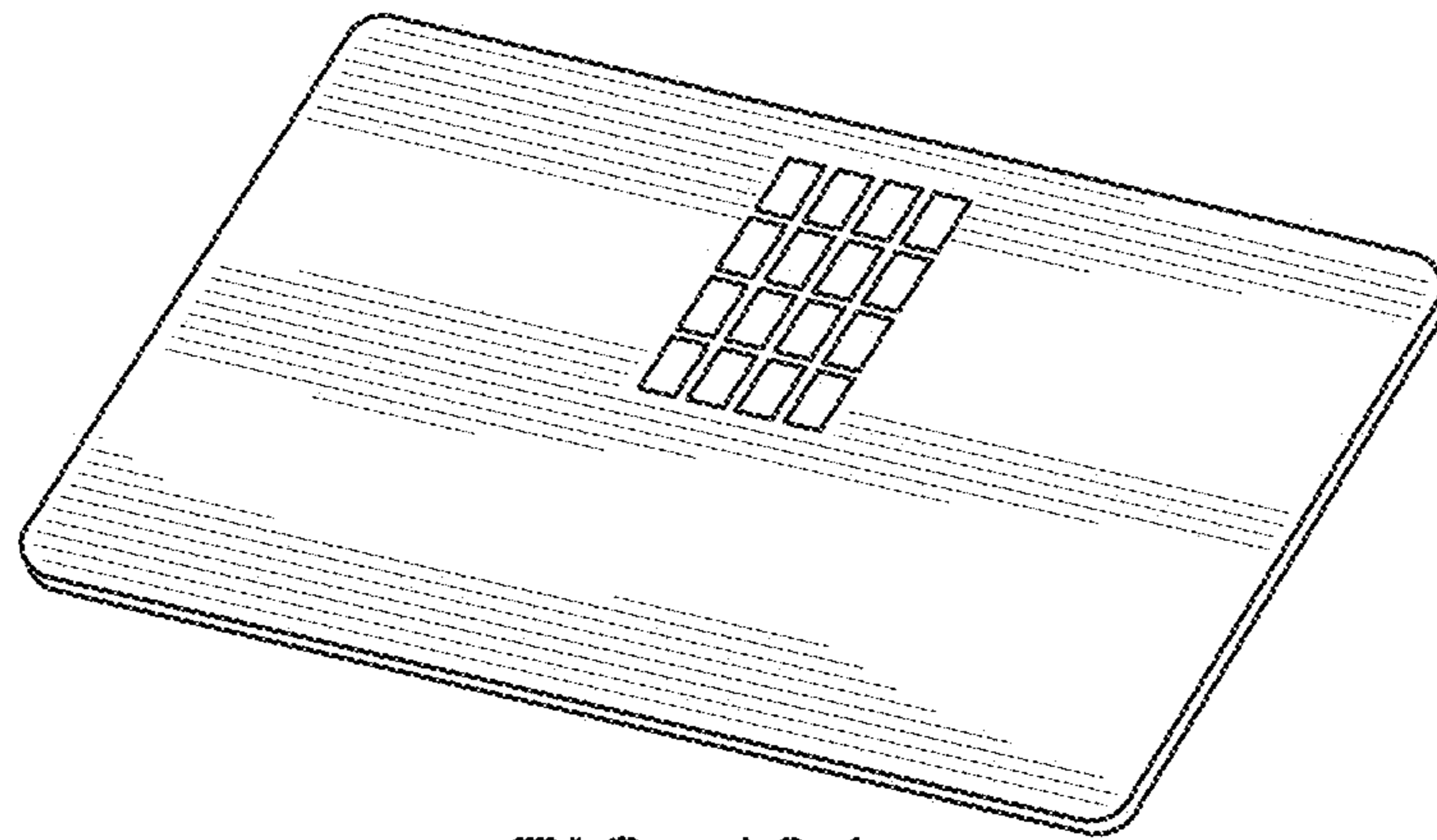

FIG. 134

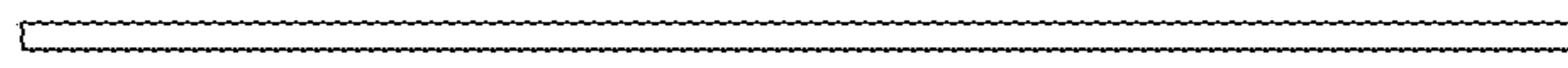

FIG. 137



FIG. 139

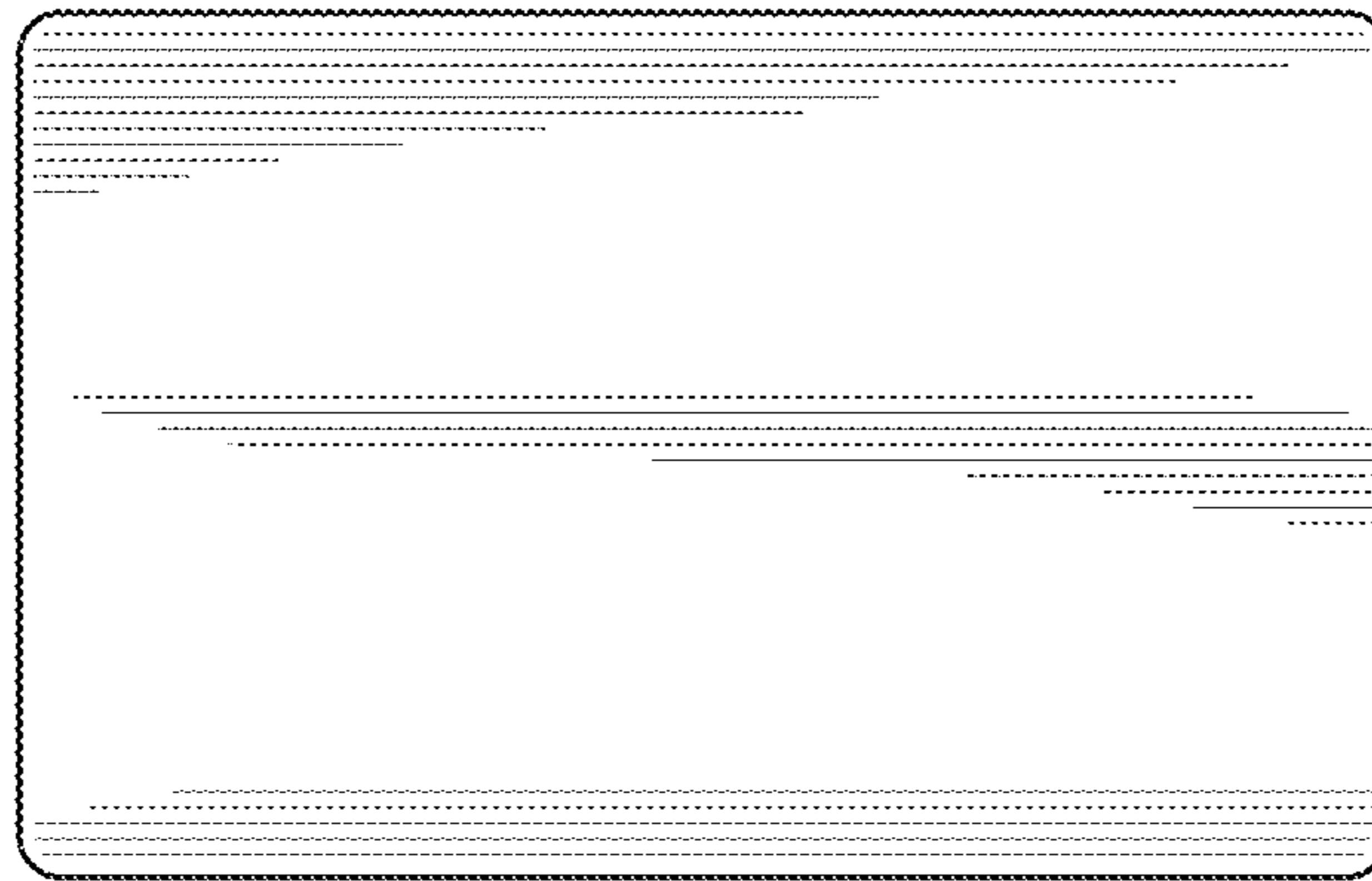

FIG. 135

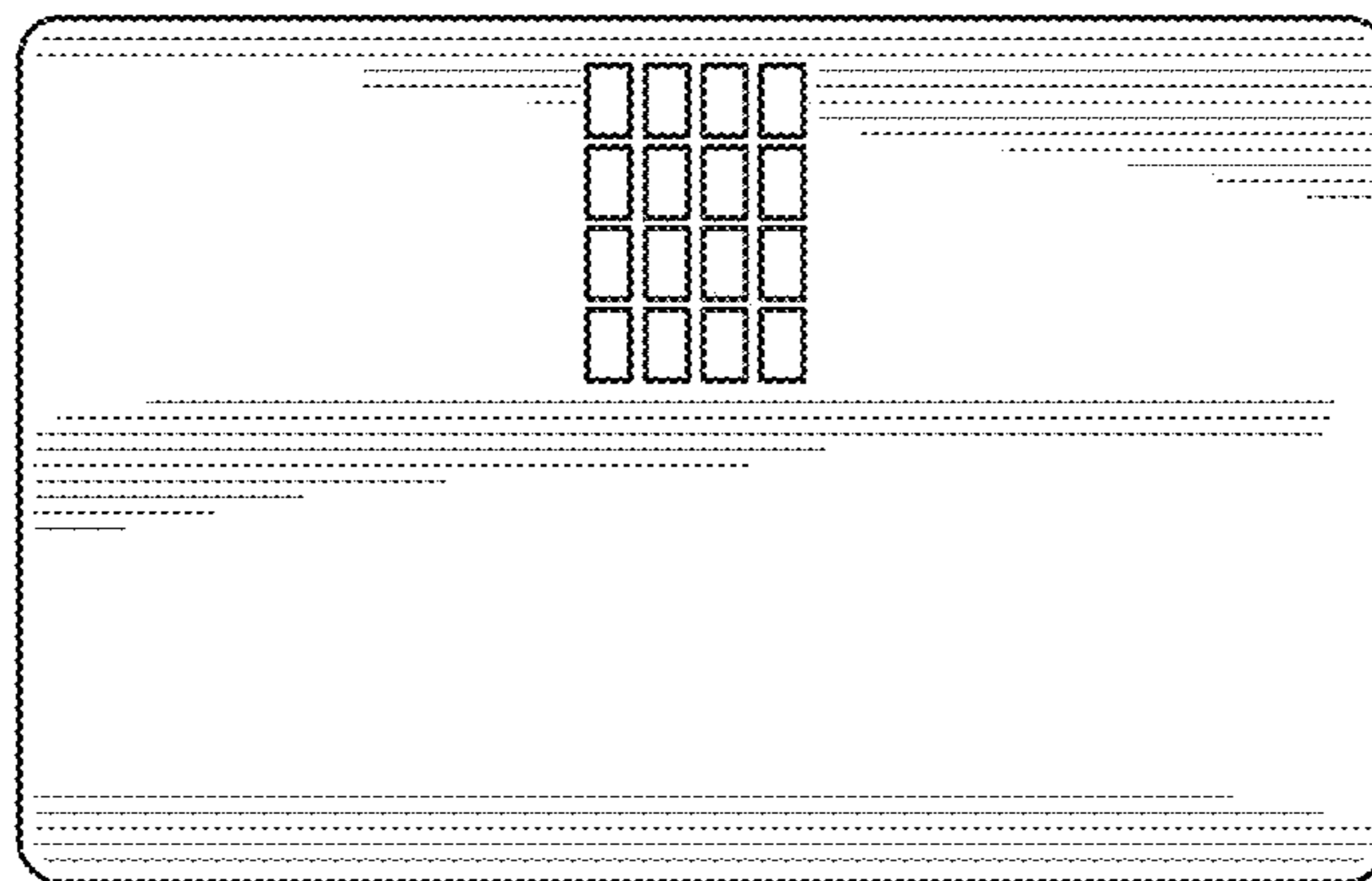

FIG. 136



FIG. 140

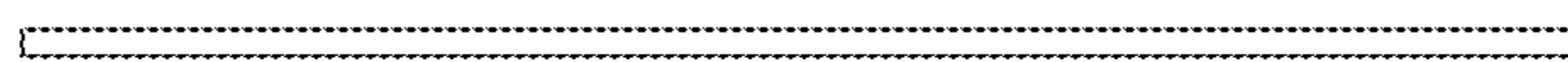

FIG. 138



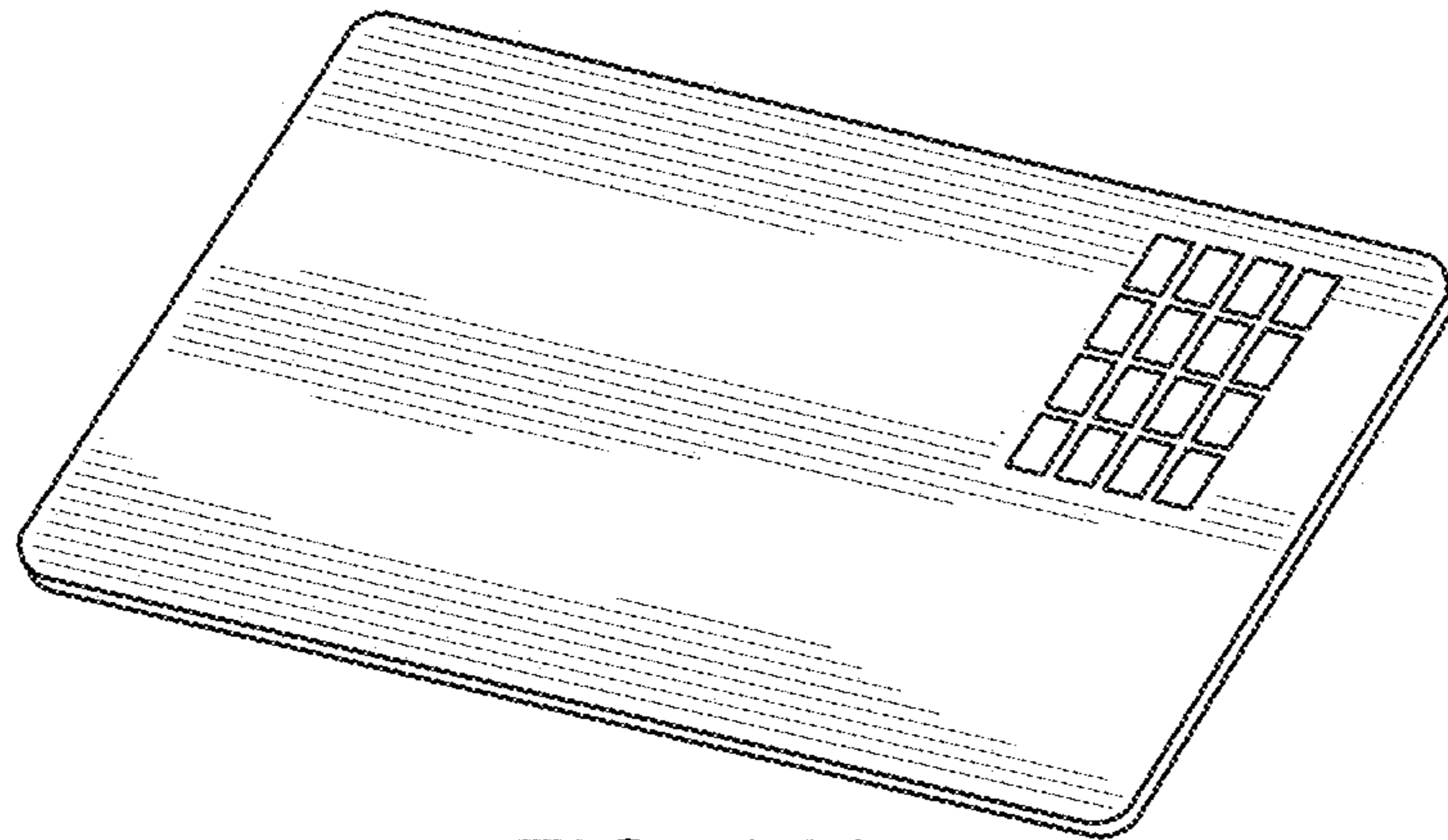

FIG. 141

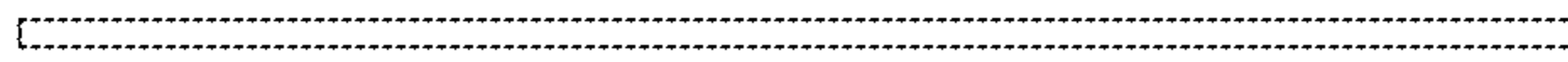

FIG. 144



FIG. 146

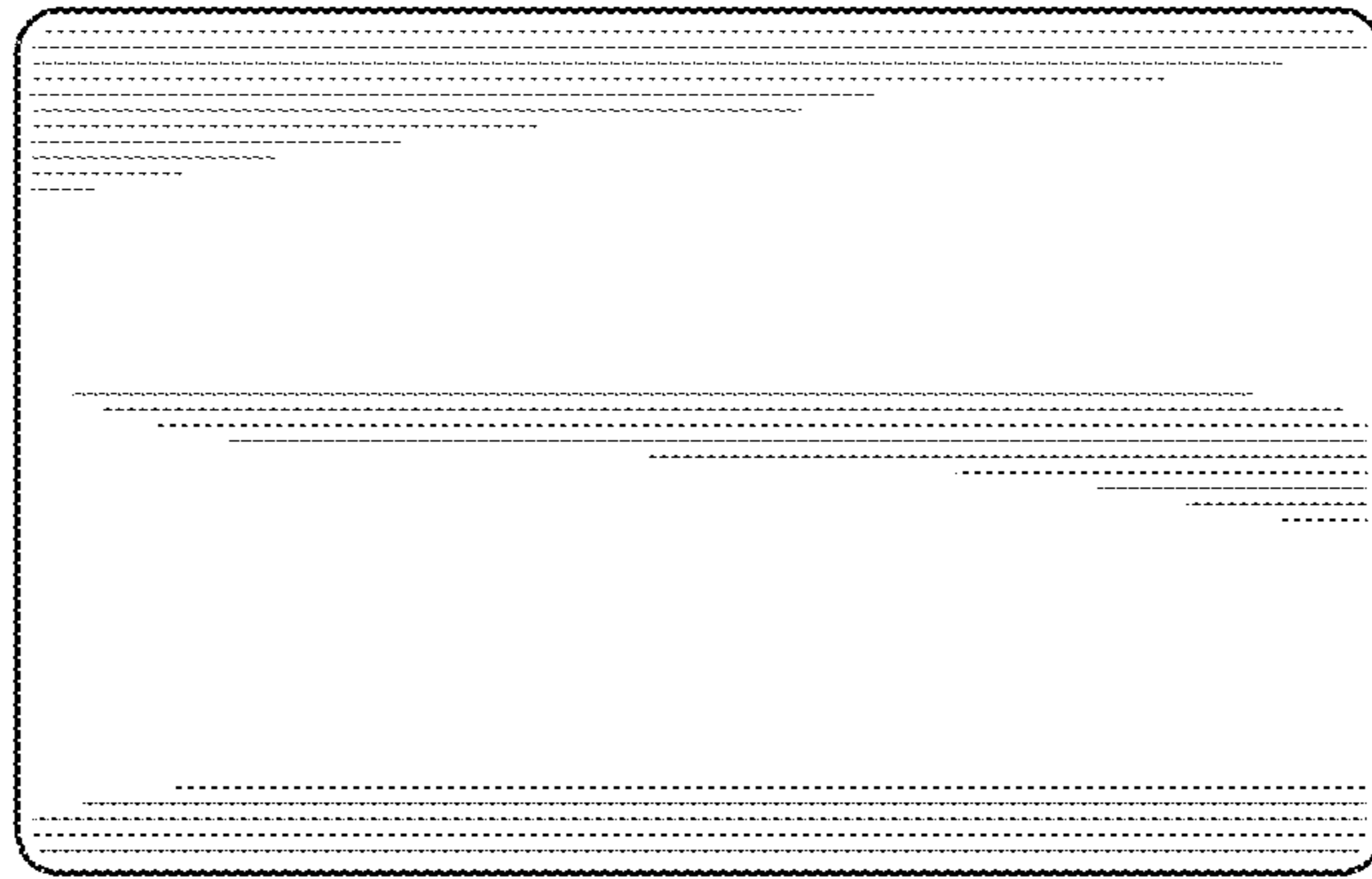

FIG. 142

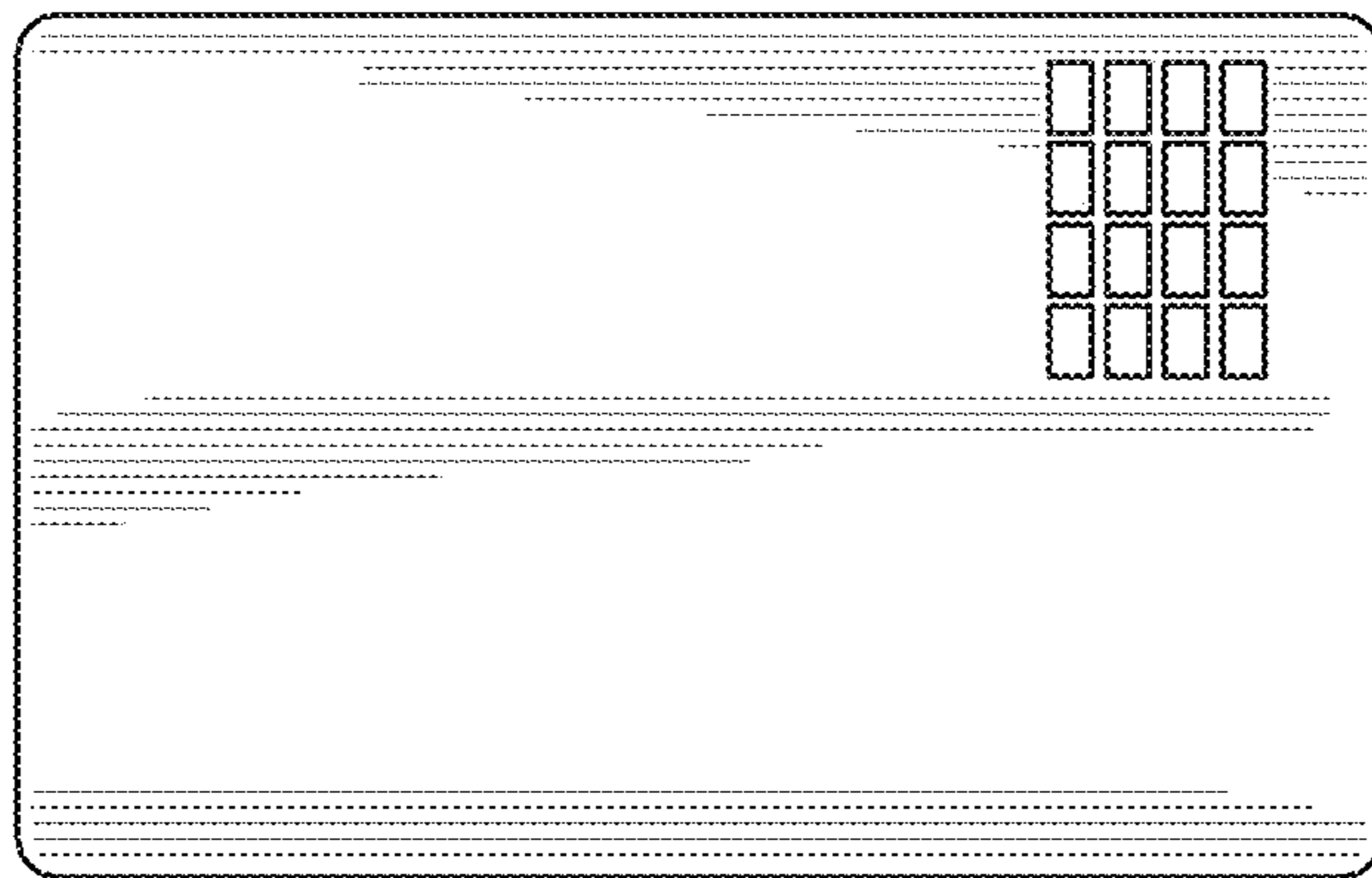

FIG. 143



FIG. 147

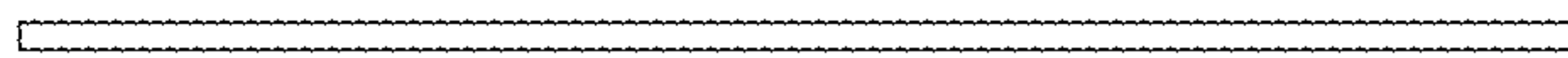

FIG. 145

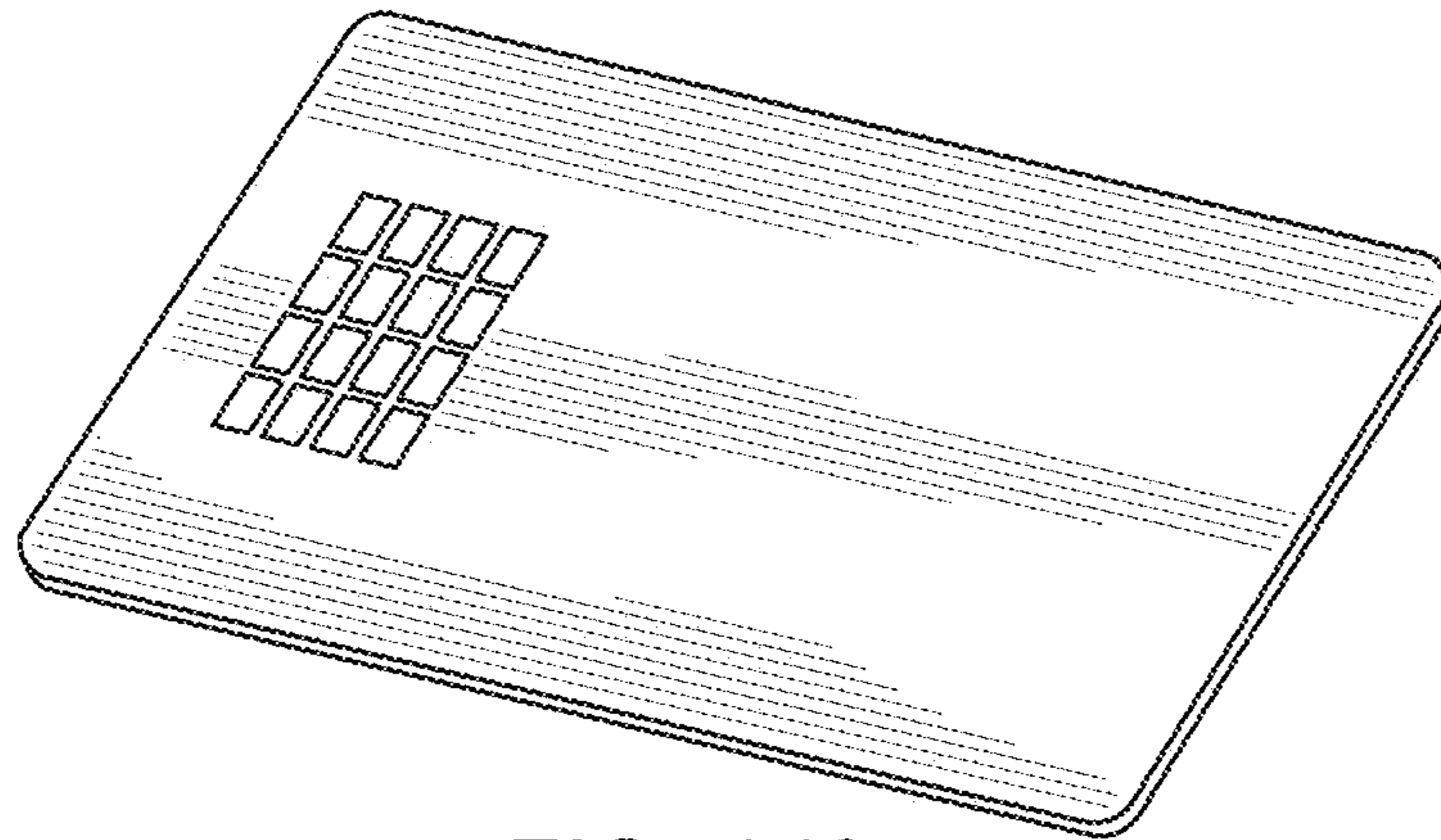

FIG. 148

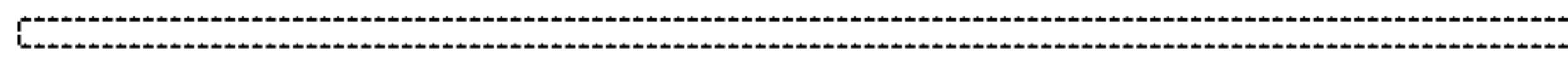

FIG. 151



FIG. 153

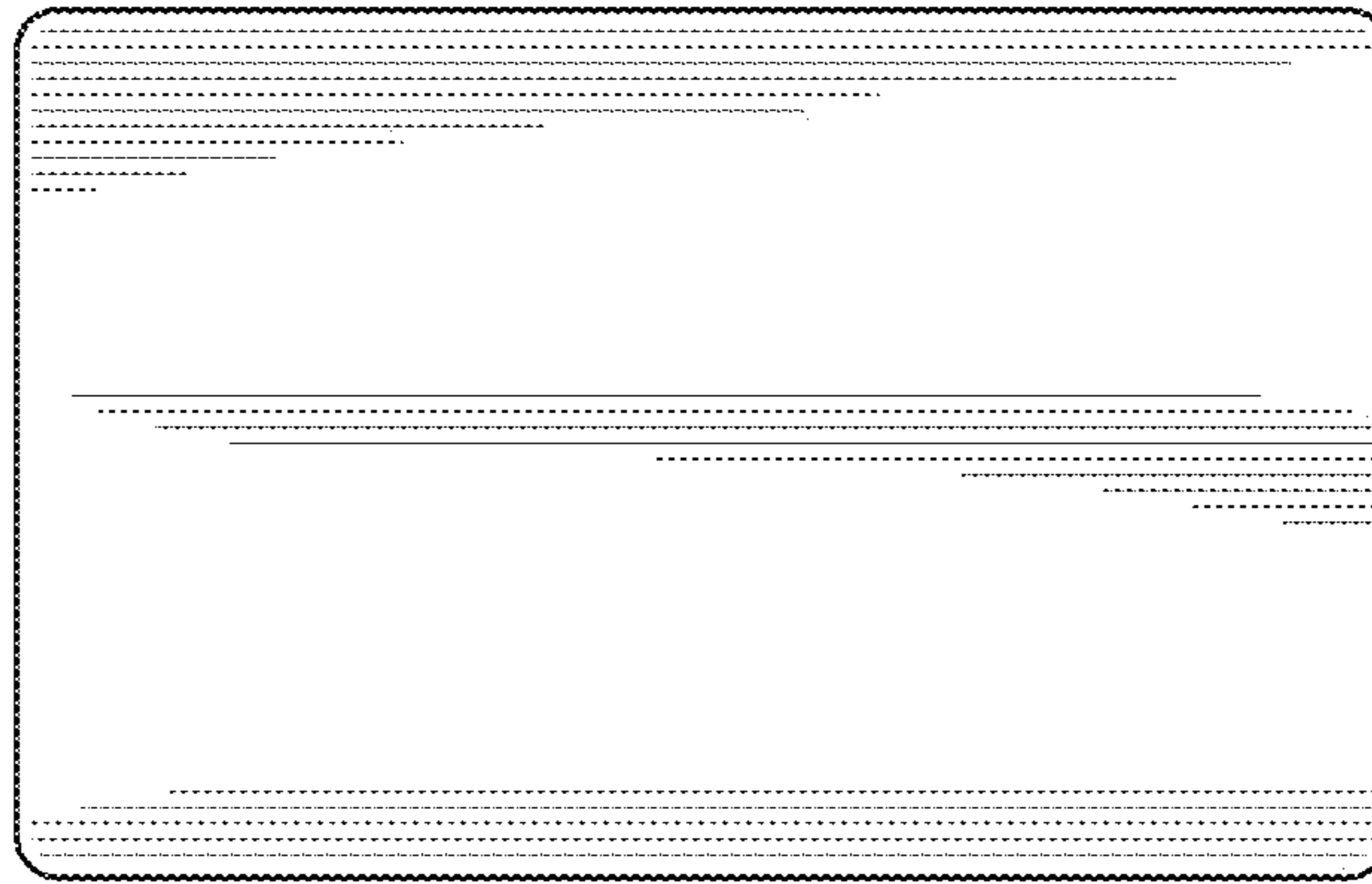

FIG. 149

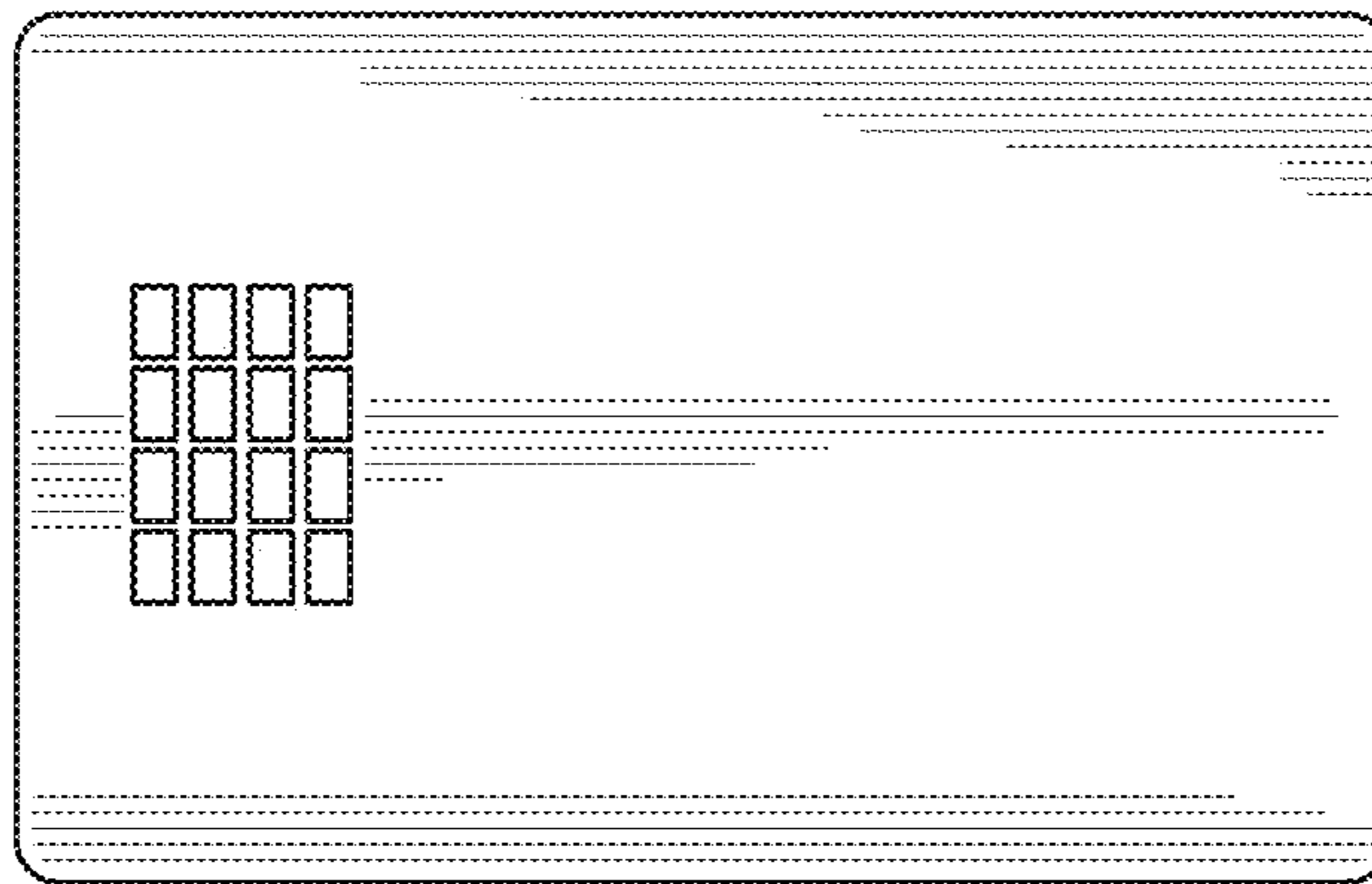

FIG. 150

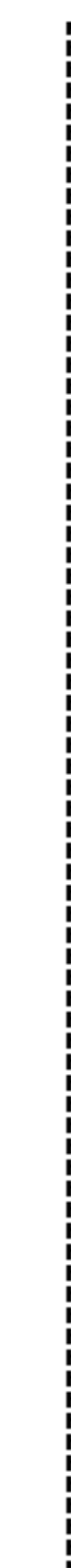

FIG. 154

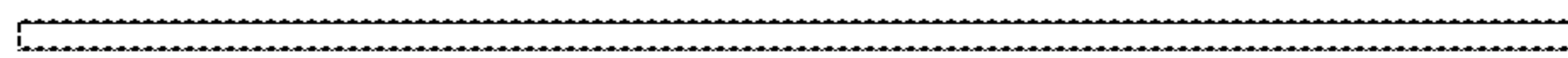

FIG. 152

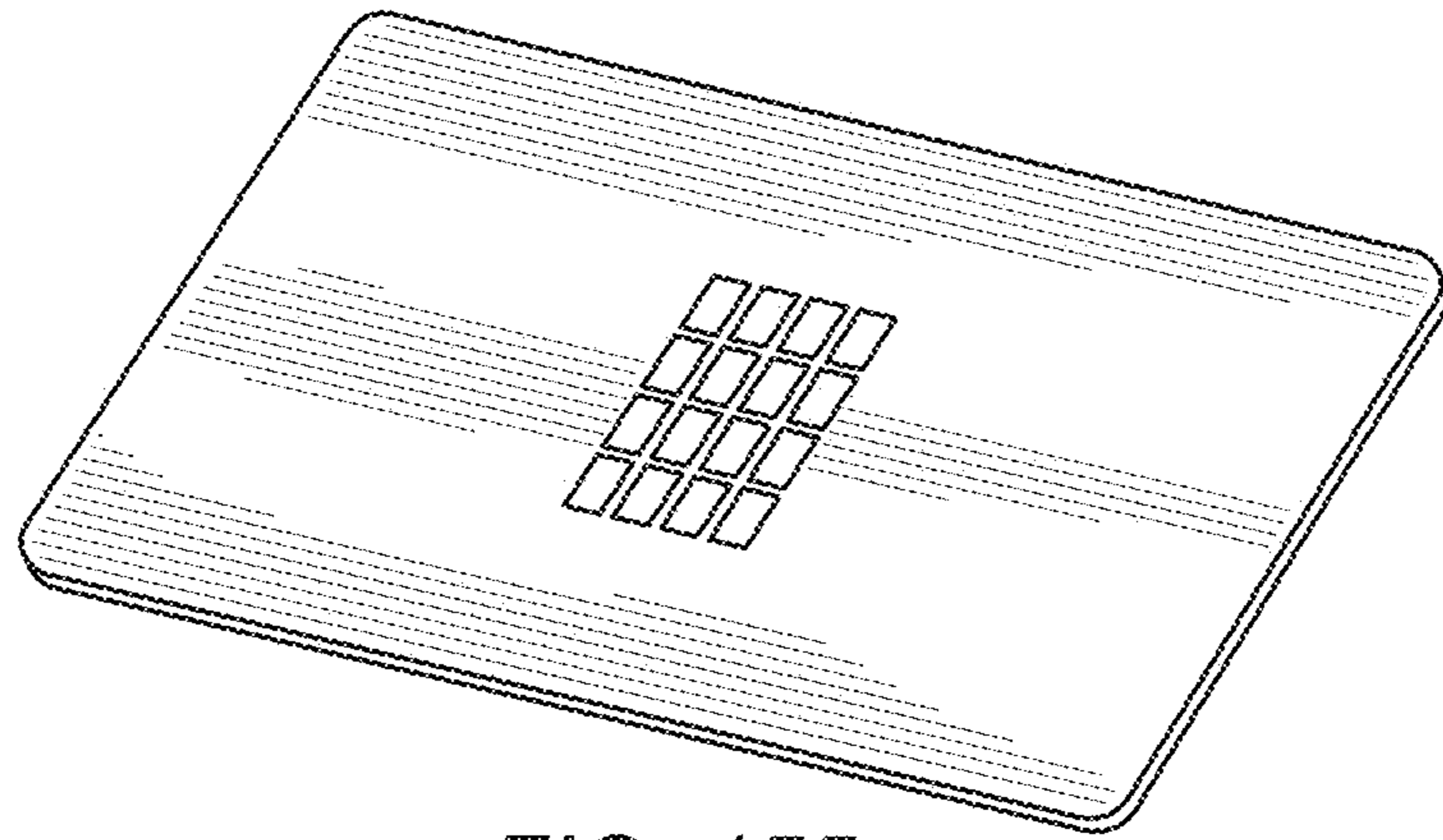

FIG. 155

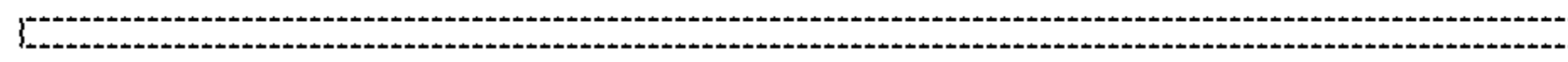

FIG. 158

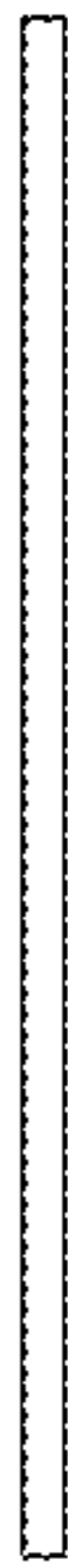

FIG. 160

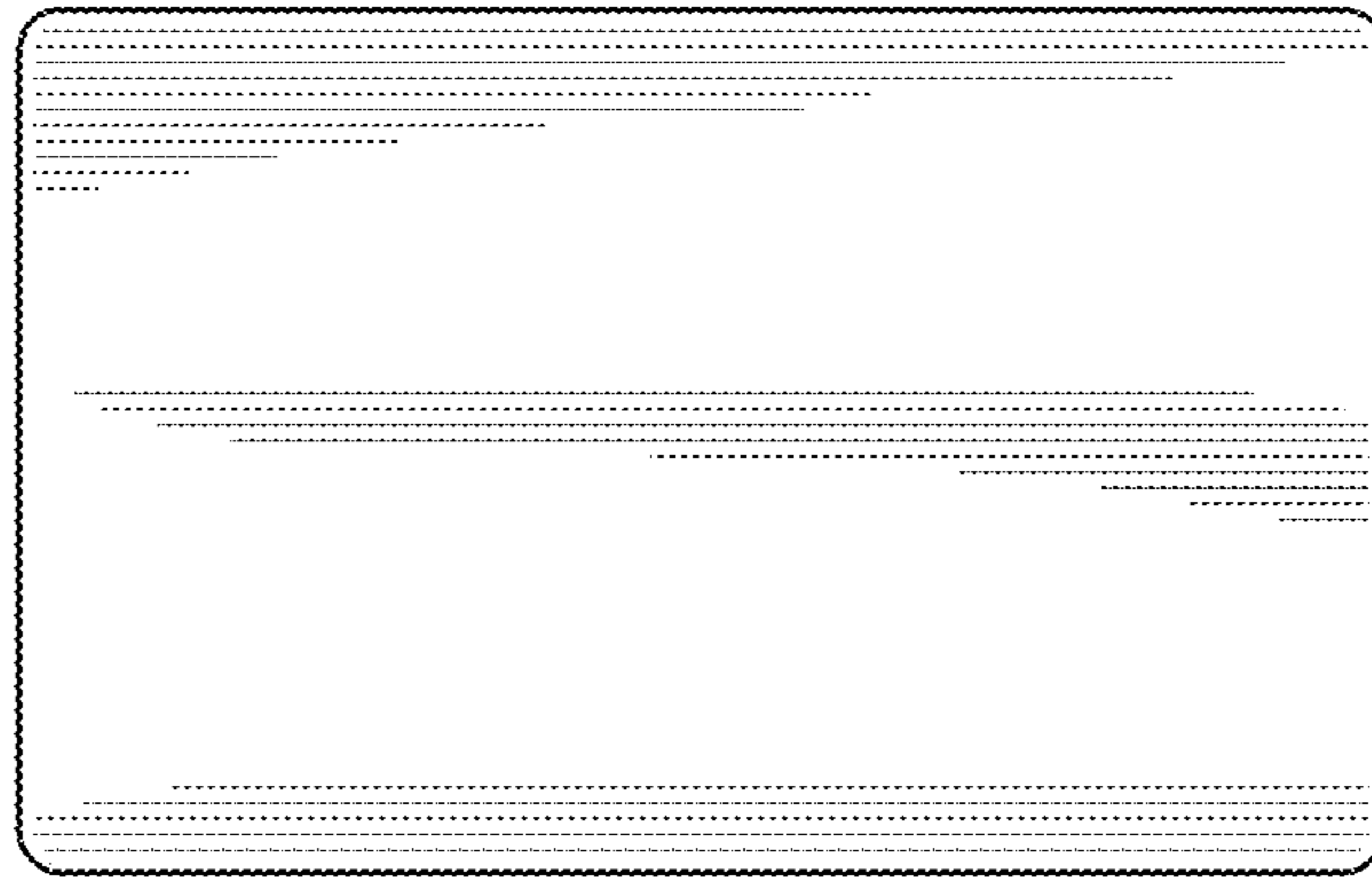

FIG. 156

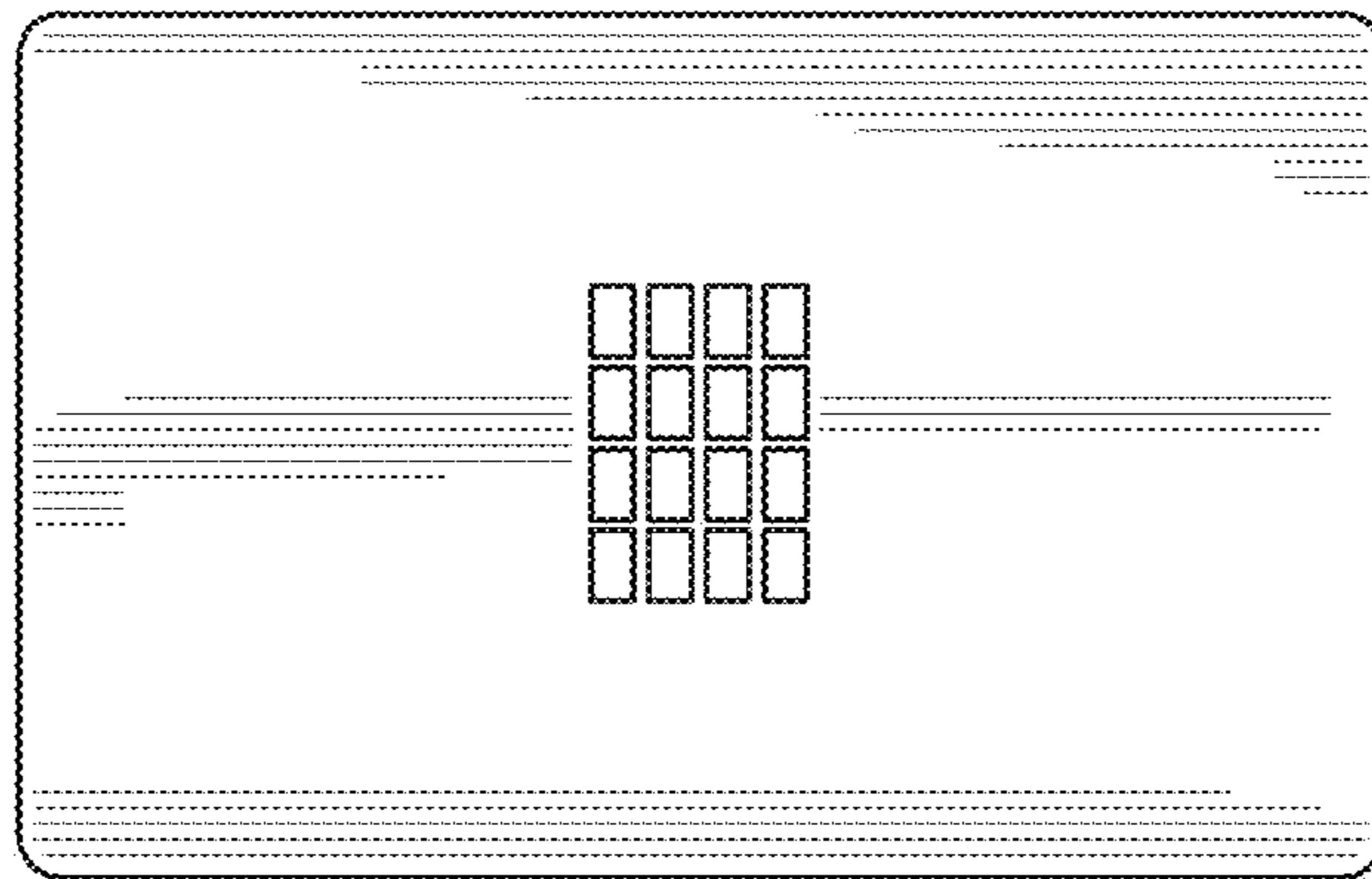

FIG. 157



FIG. 161

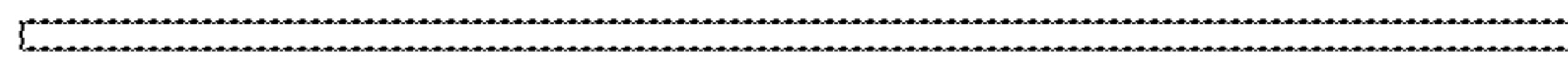

FIG. 159

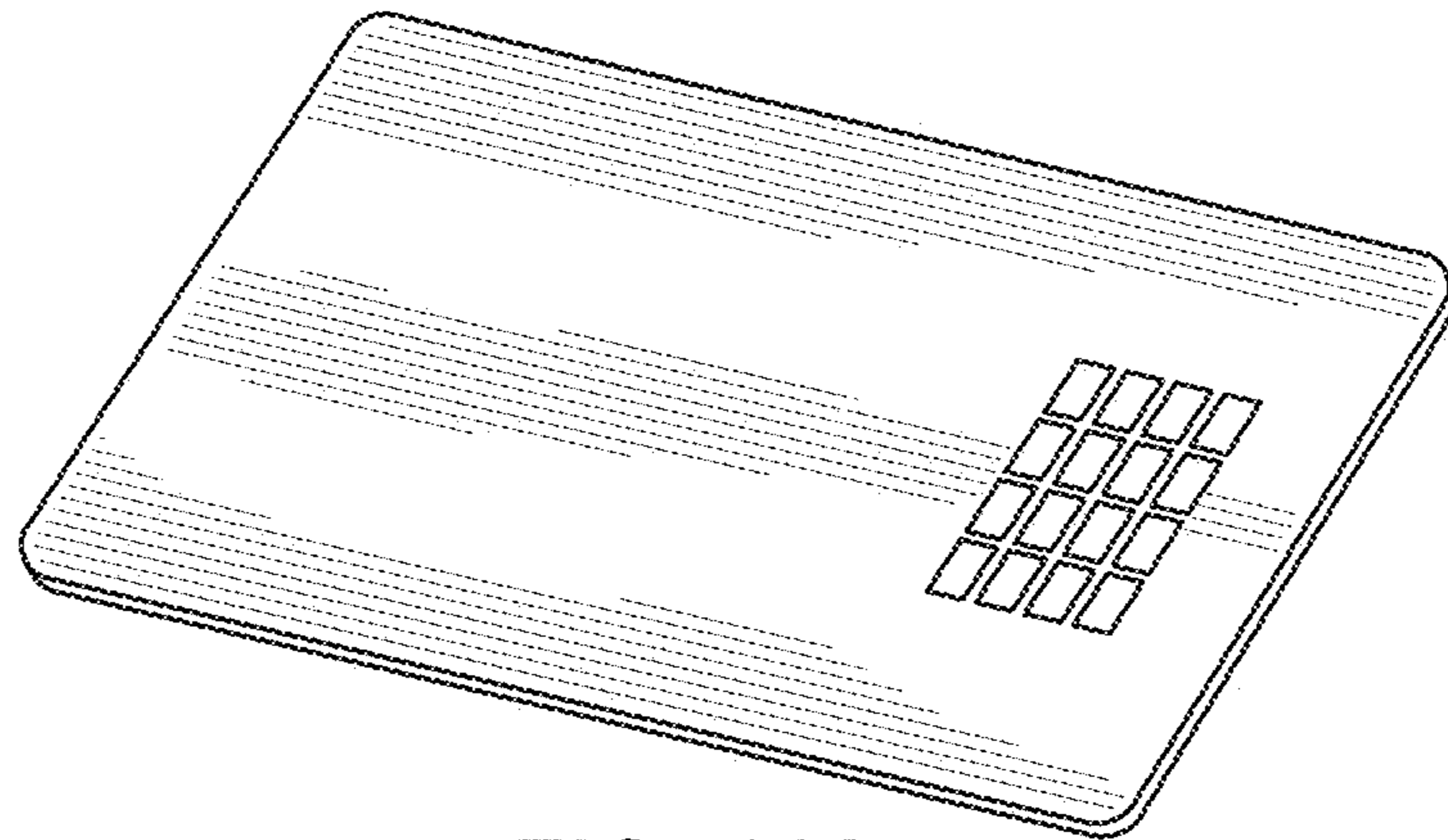

FIG. 162

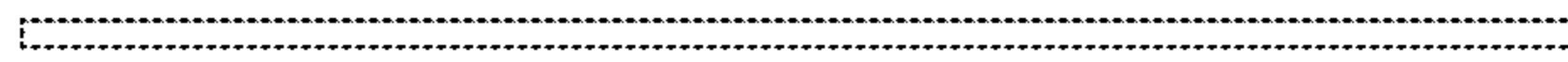

FIG. 165



FIG. 167

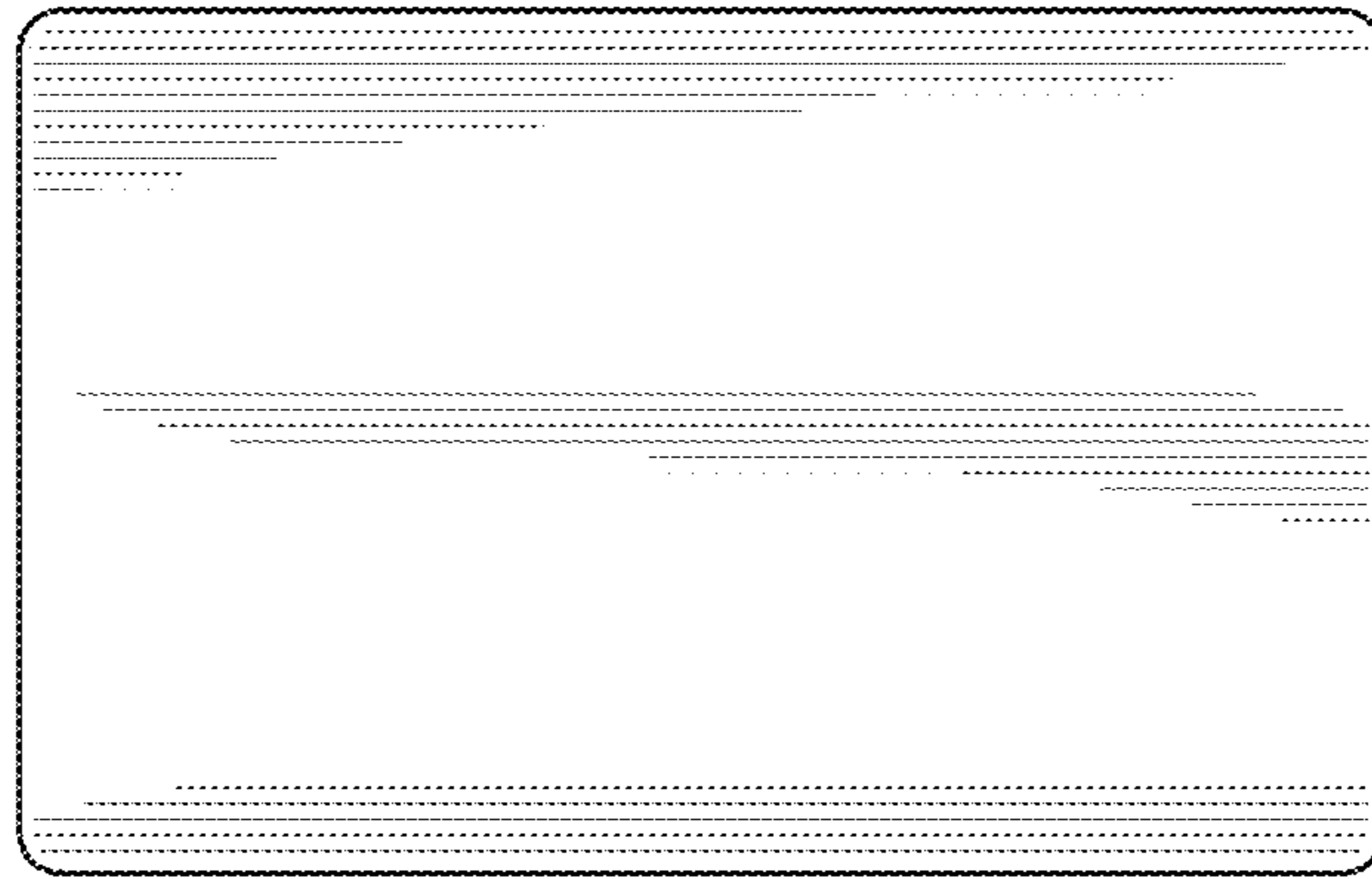

FIG. 163

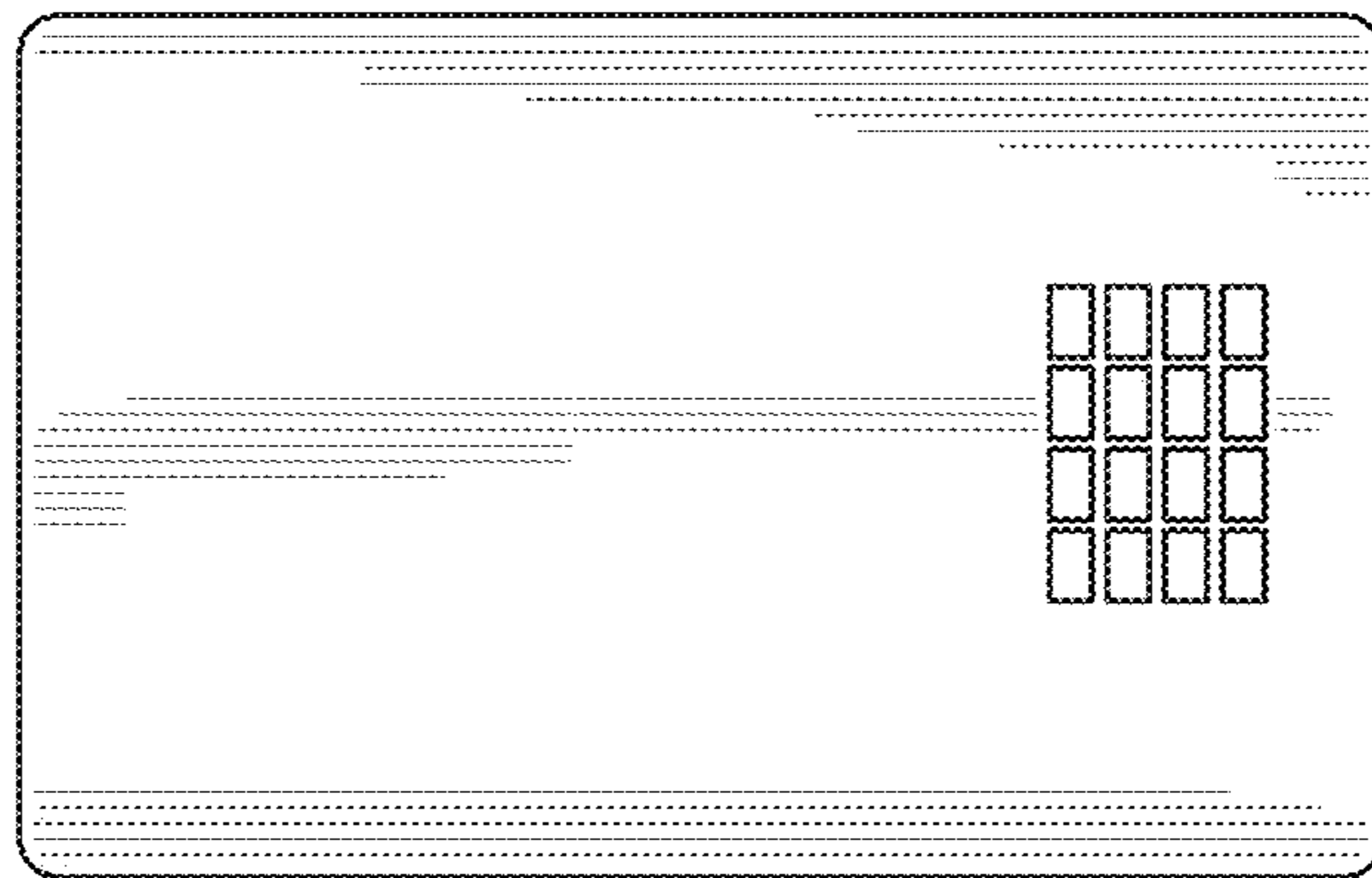

FIG. 164



FIG. 168

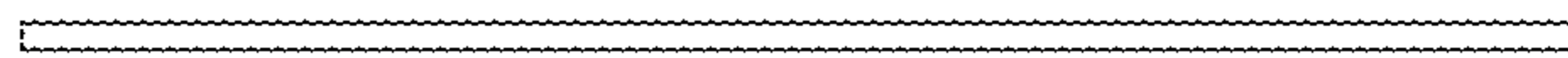

FIG. 166

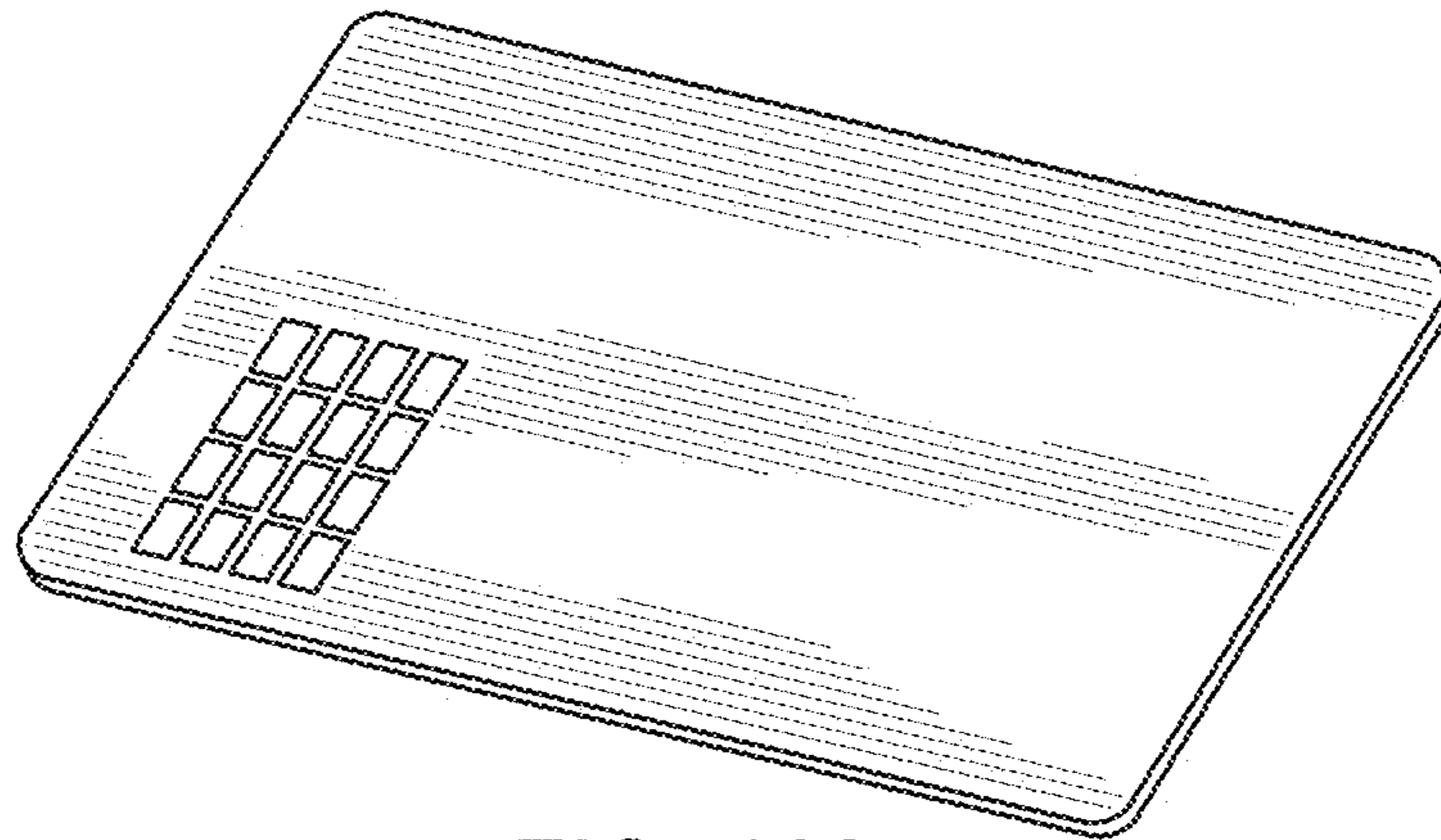

FIG. 169

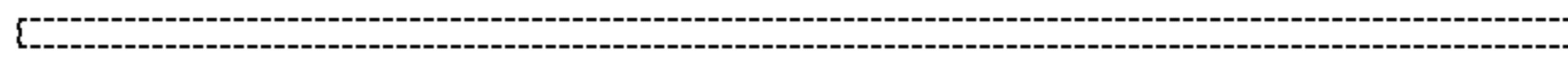

FIG. 172

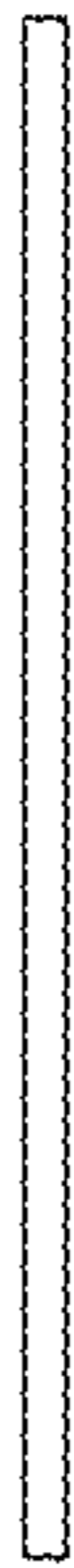

FIG. 174

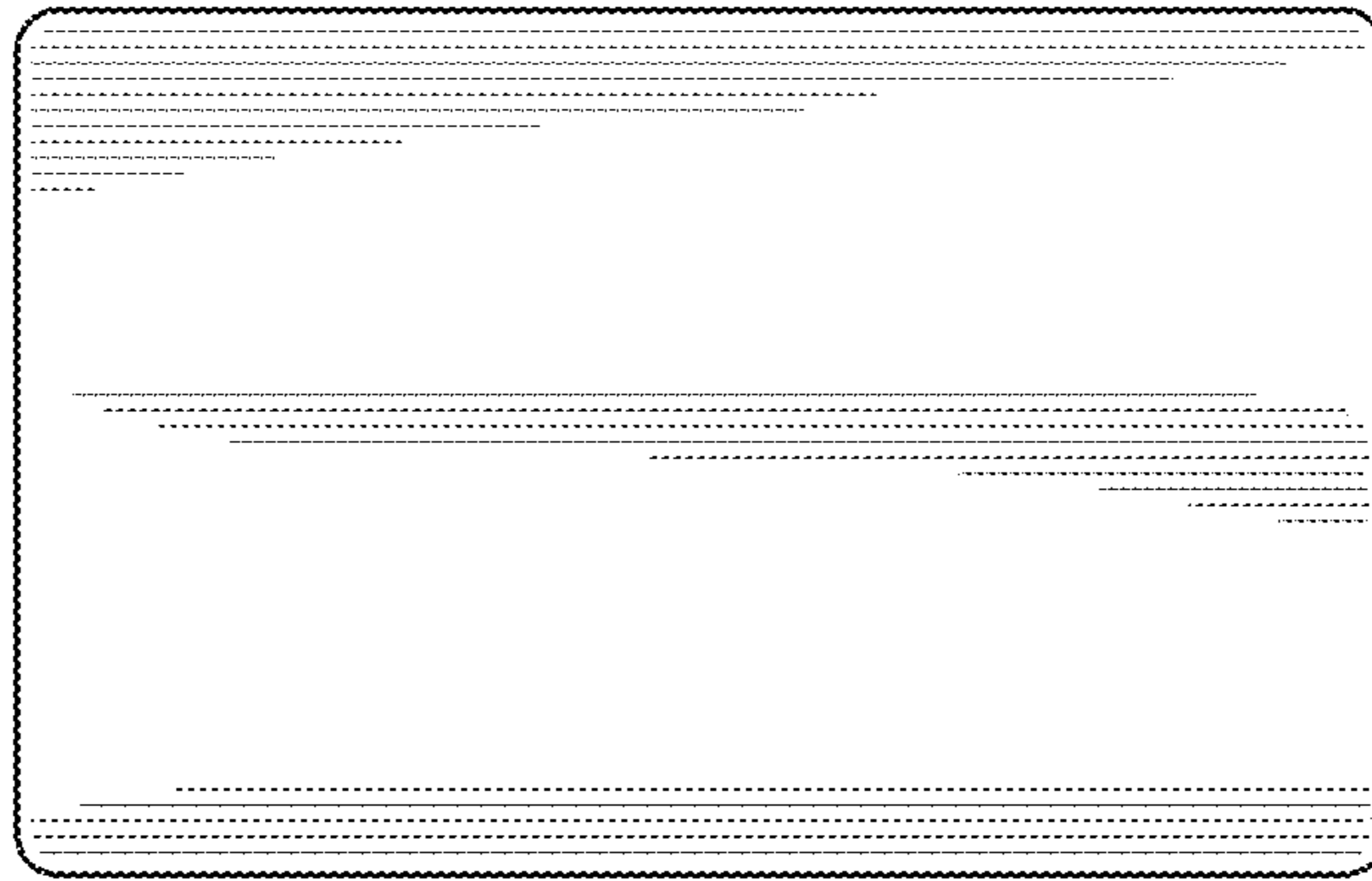

FIG. 170

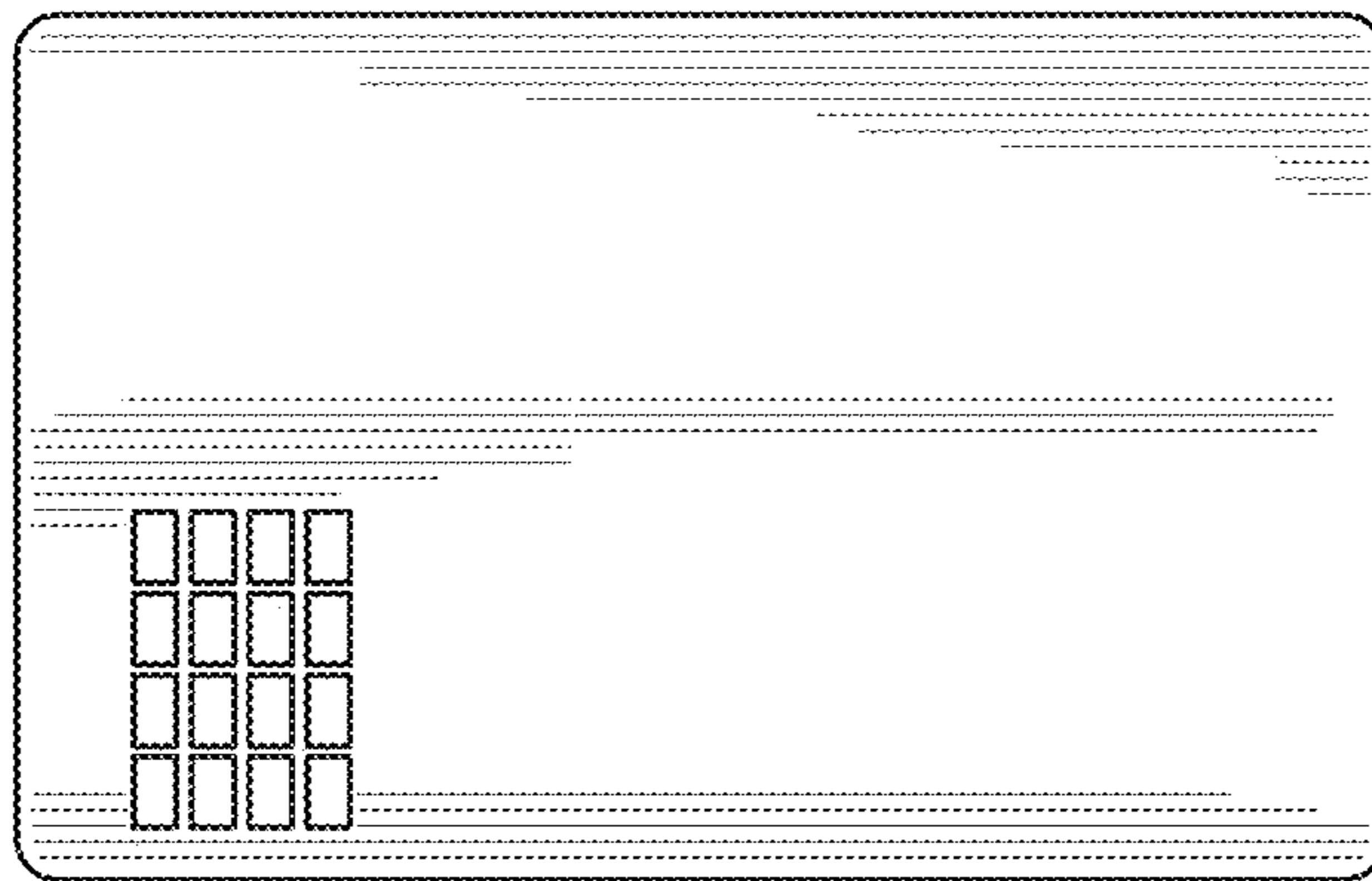

FIG. 171

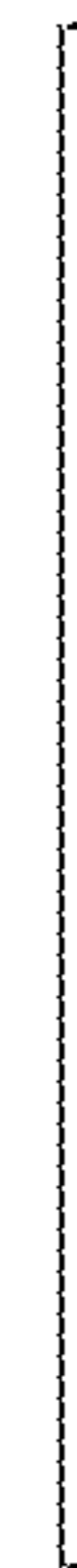

FIG. 175

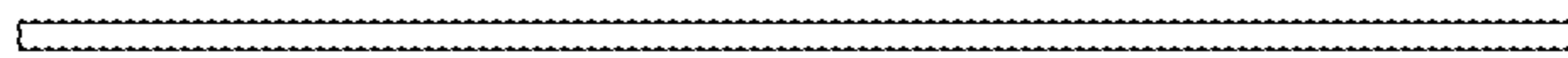

FIG. 173

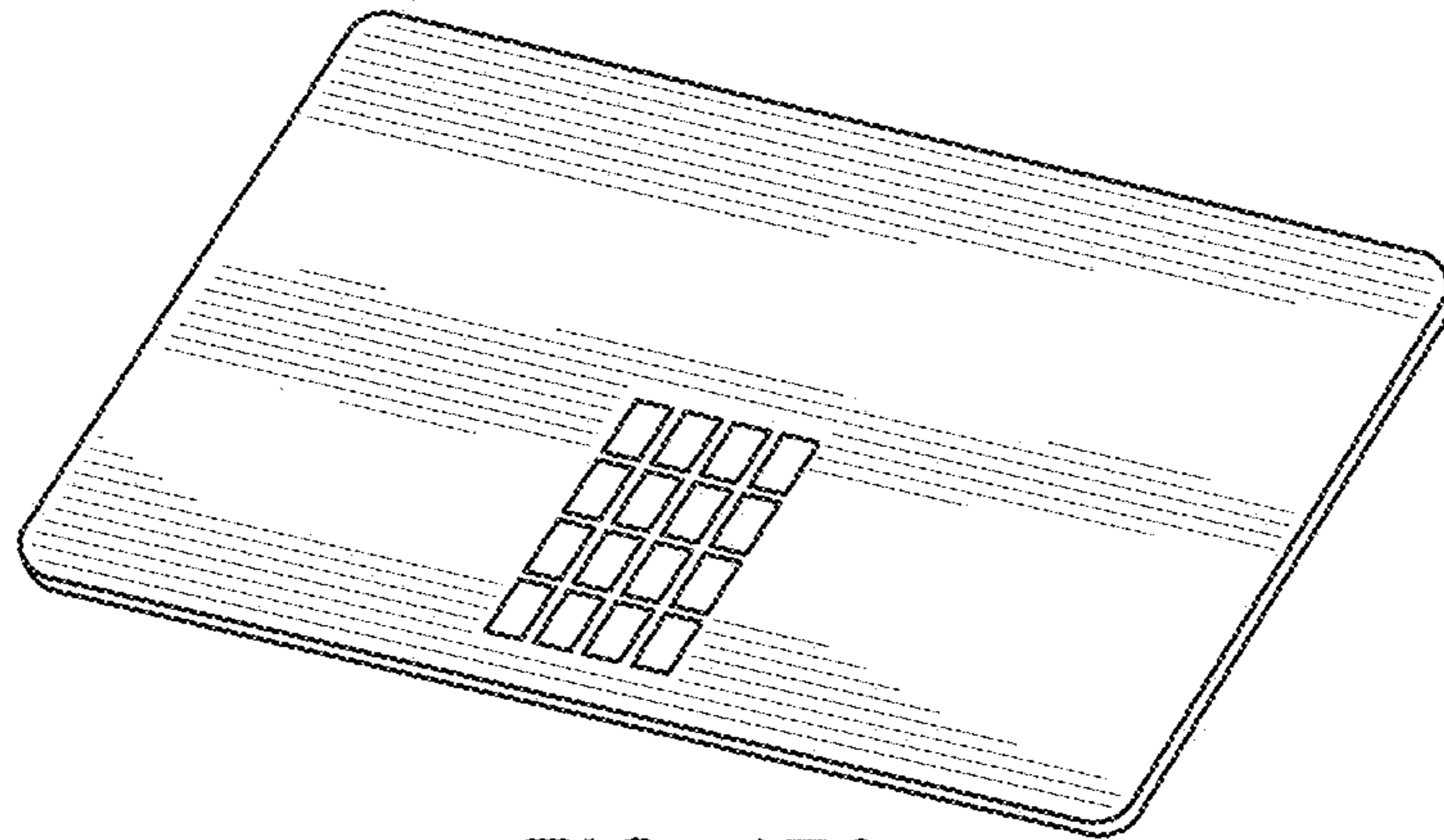

FIG. 176

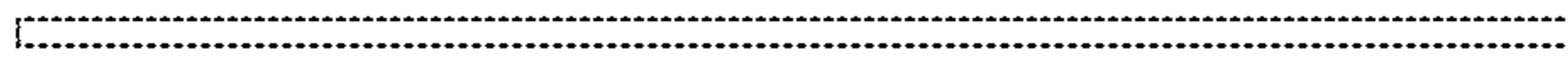

FIG. 179

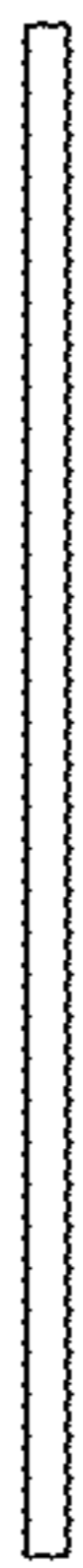

FIG. 181

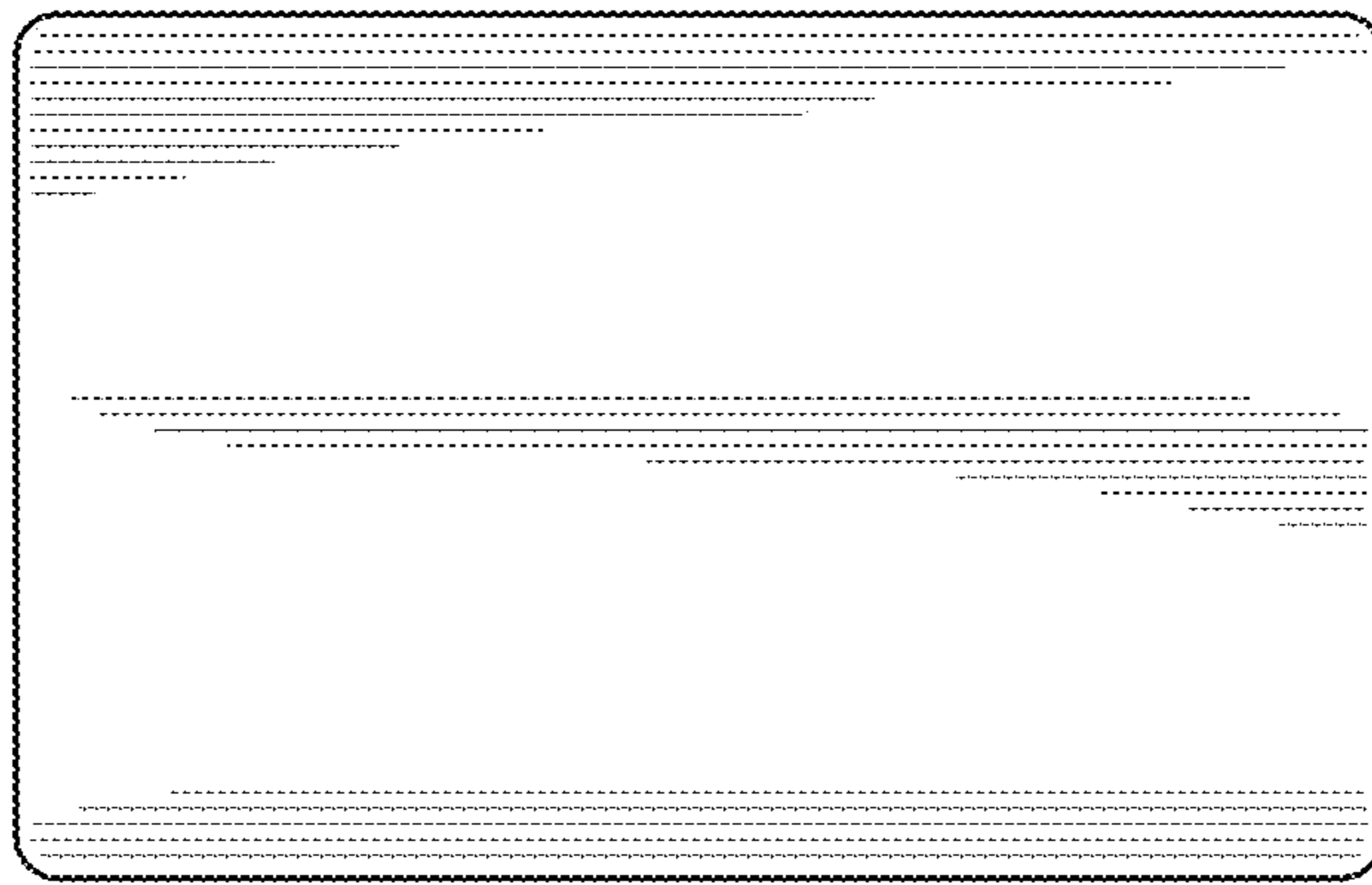

FIG. 177

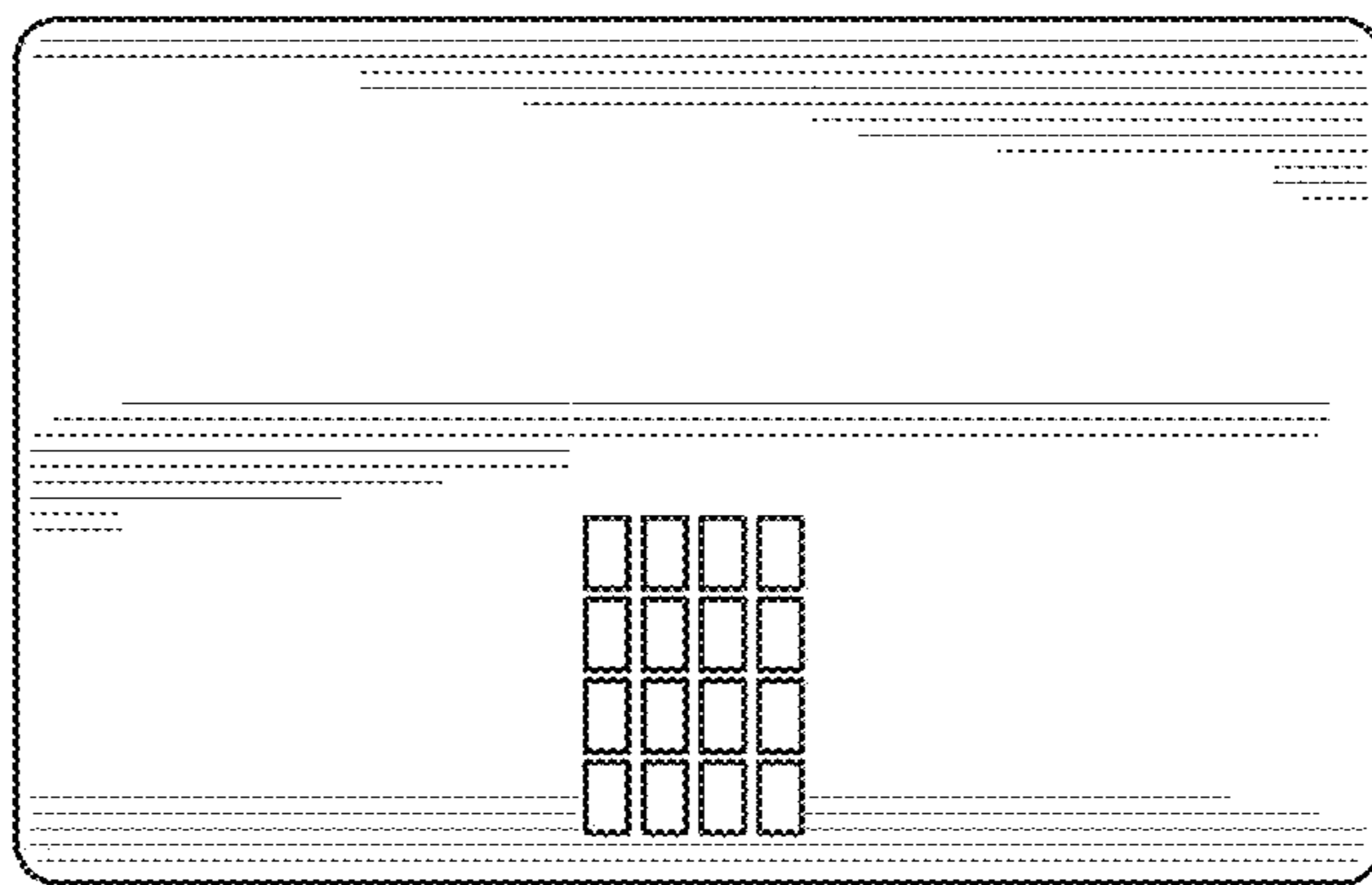

FIG. 178

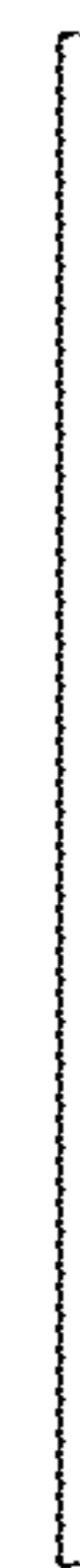

FIG. 182

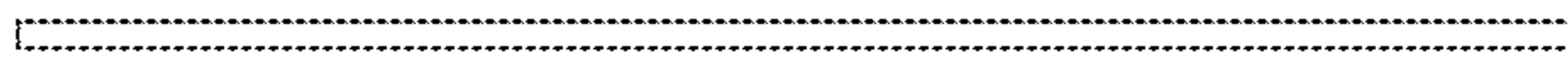

FIG. 180

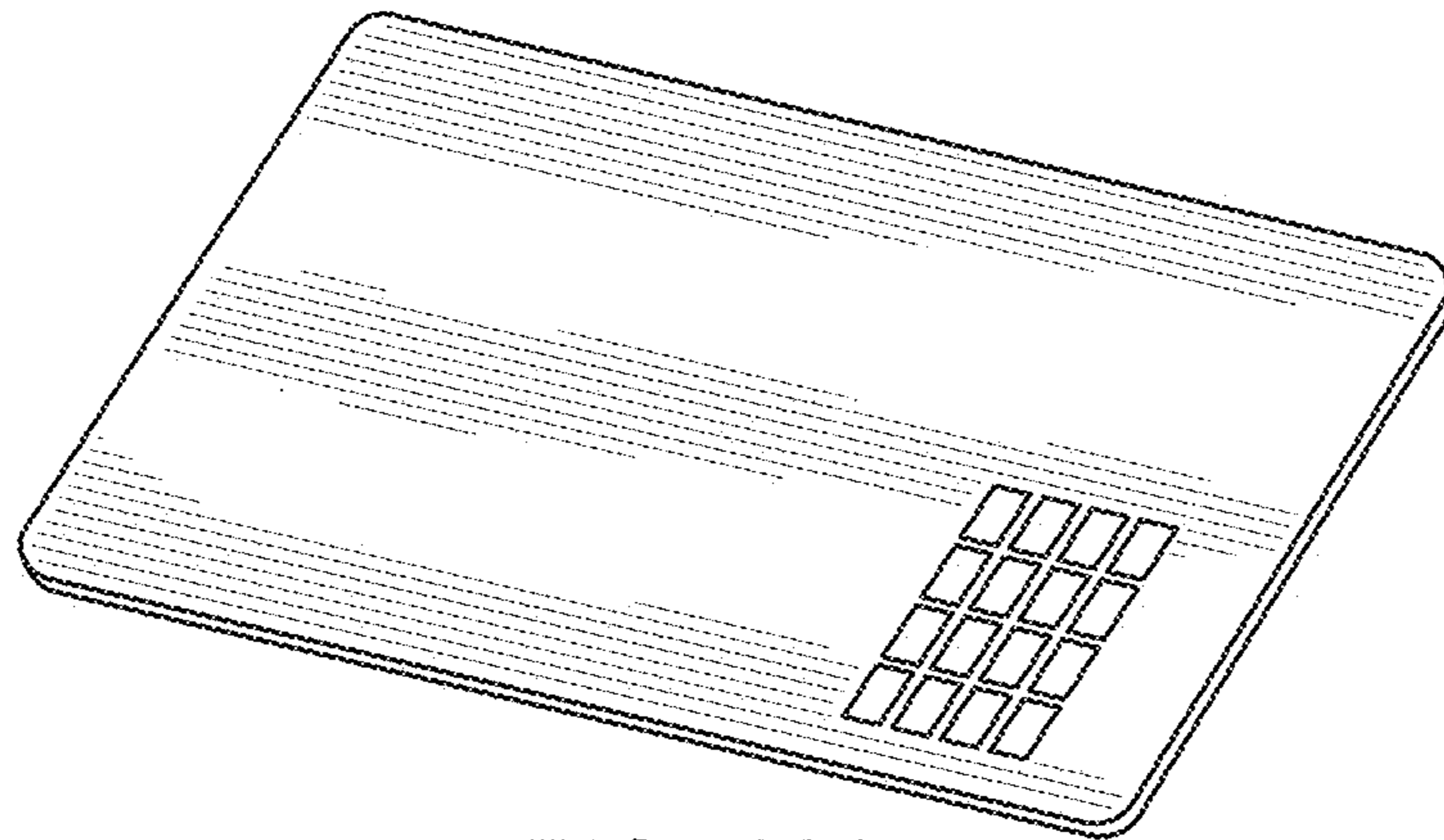

FIG. 183

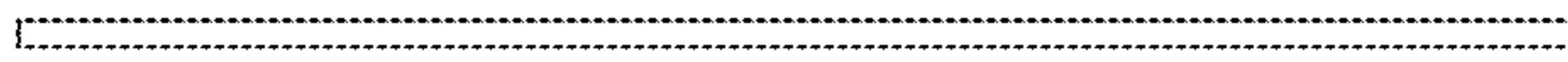

FIG. 186

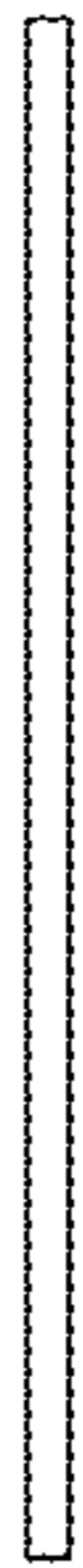

FIG. 188

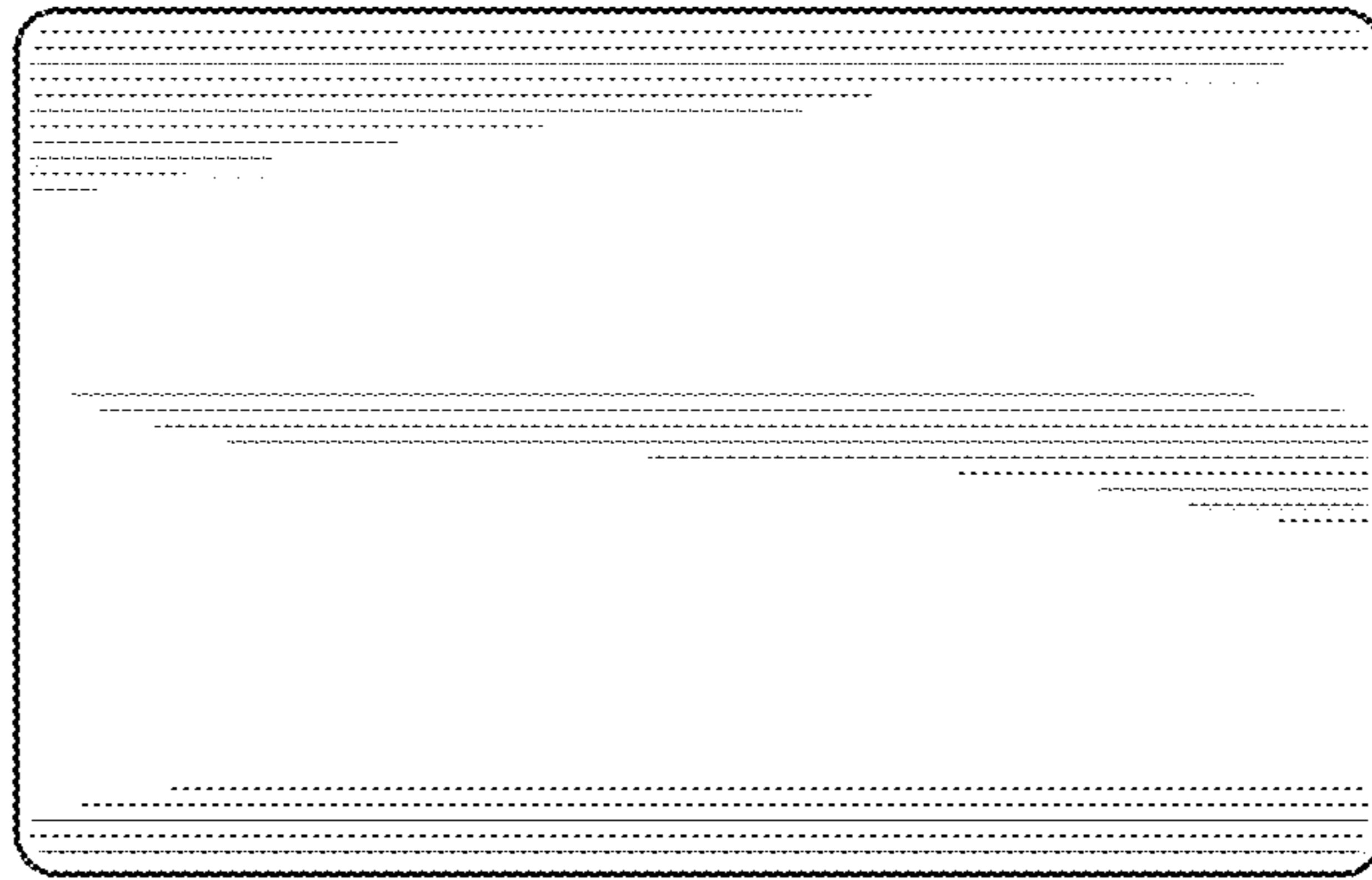

FIG. 184

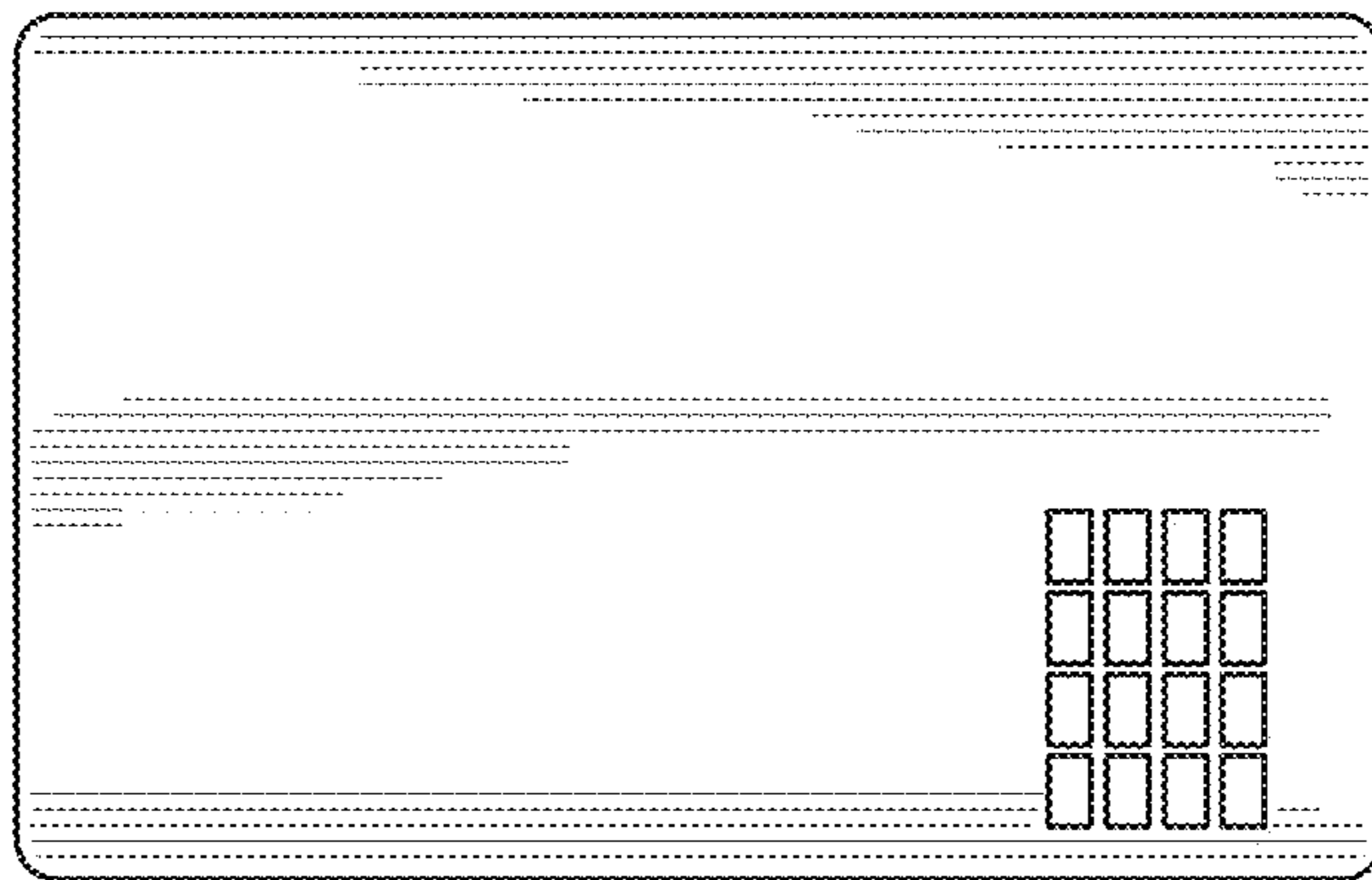

FIG. 185

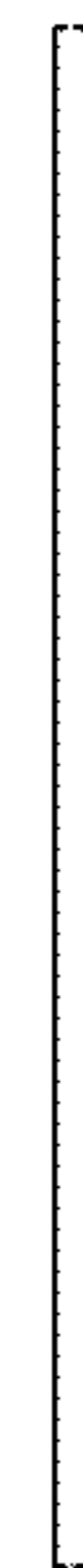

FIG. 189

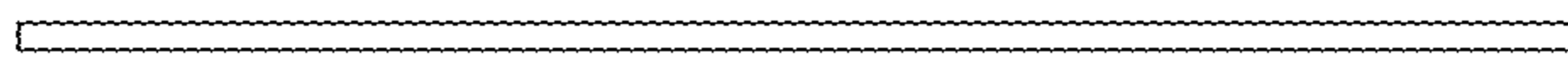

FIG. 187

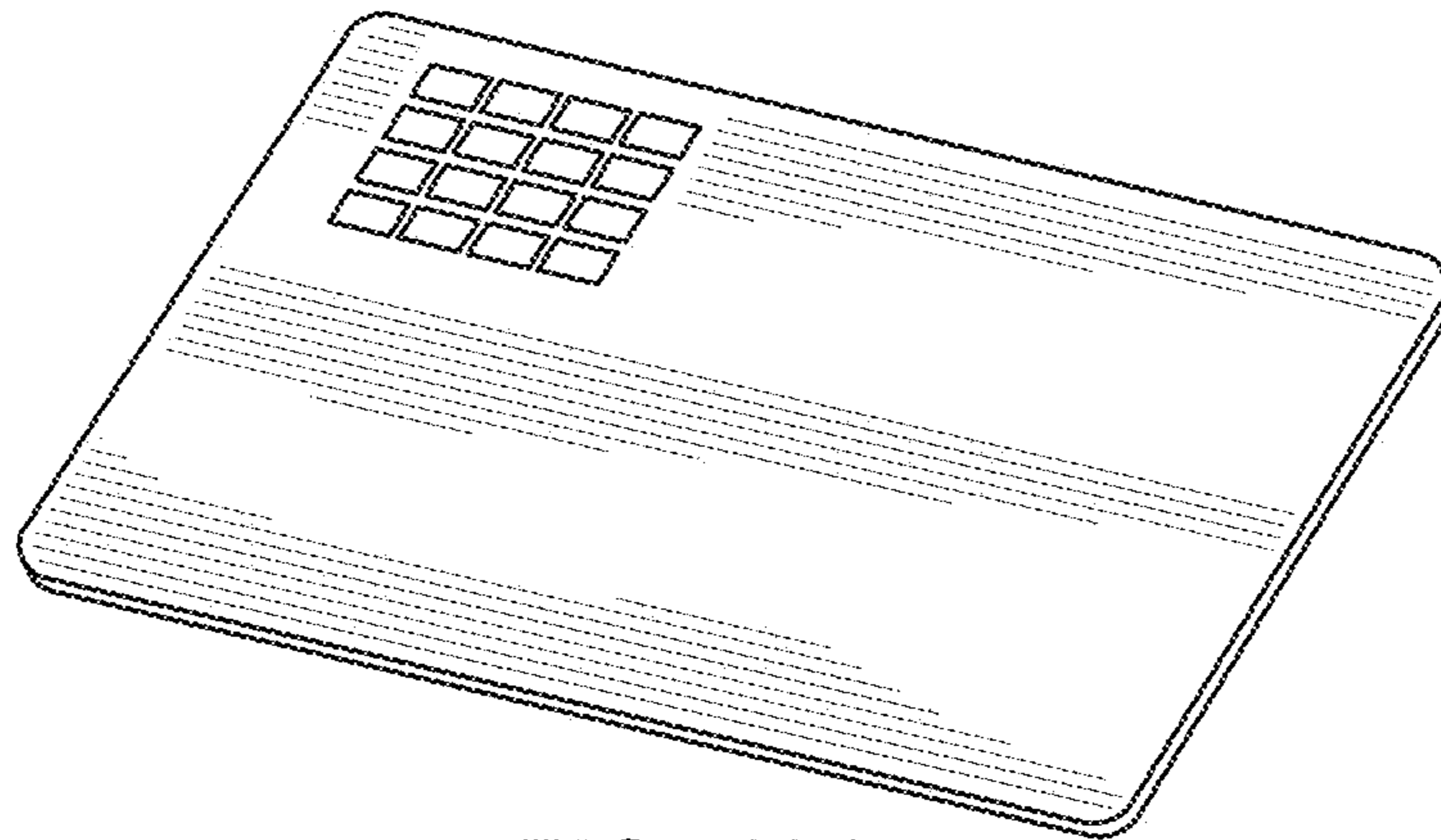

FIG. 190



FIG. 193



FIG. 195

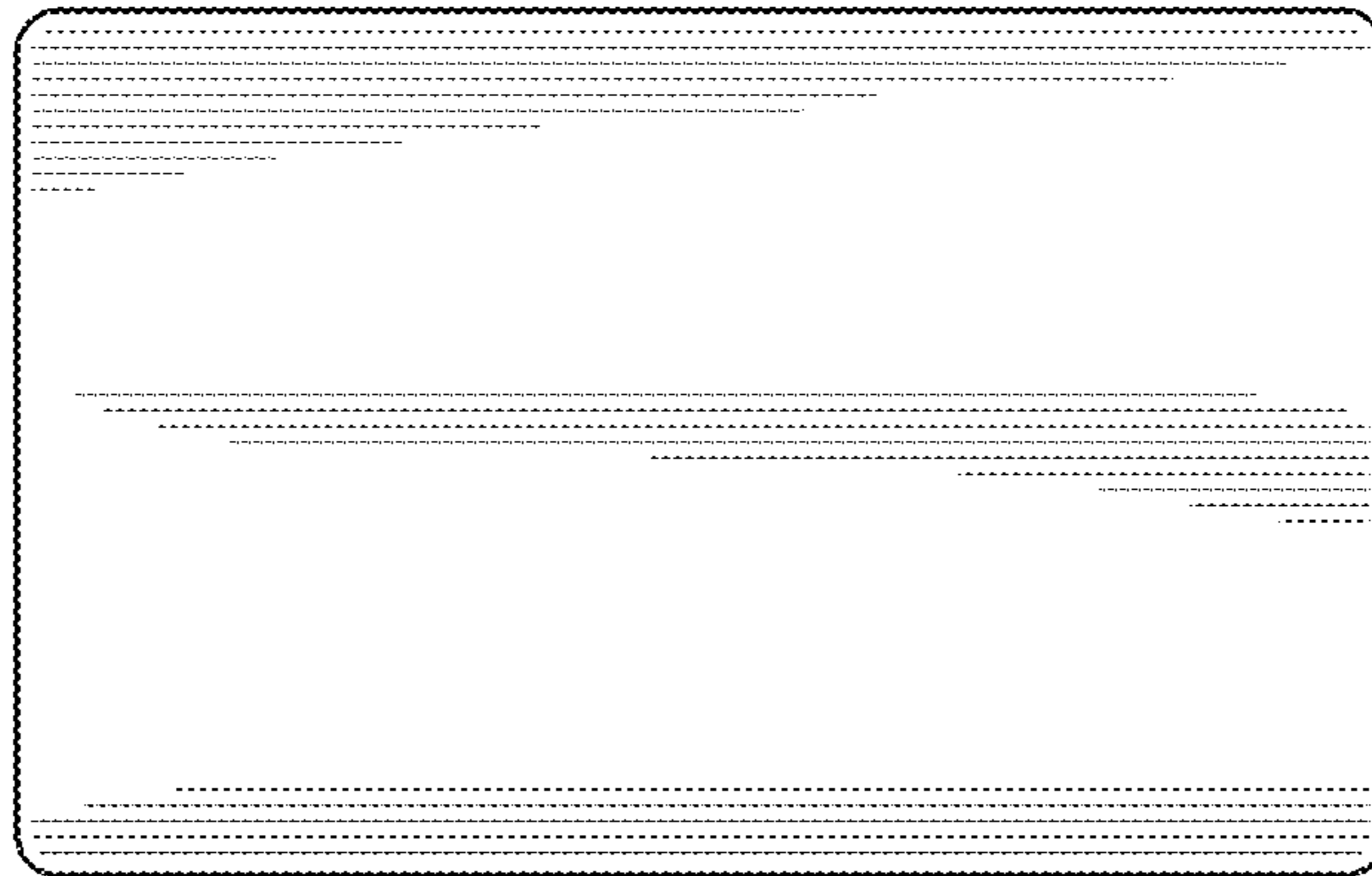

FIG. 191

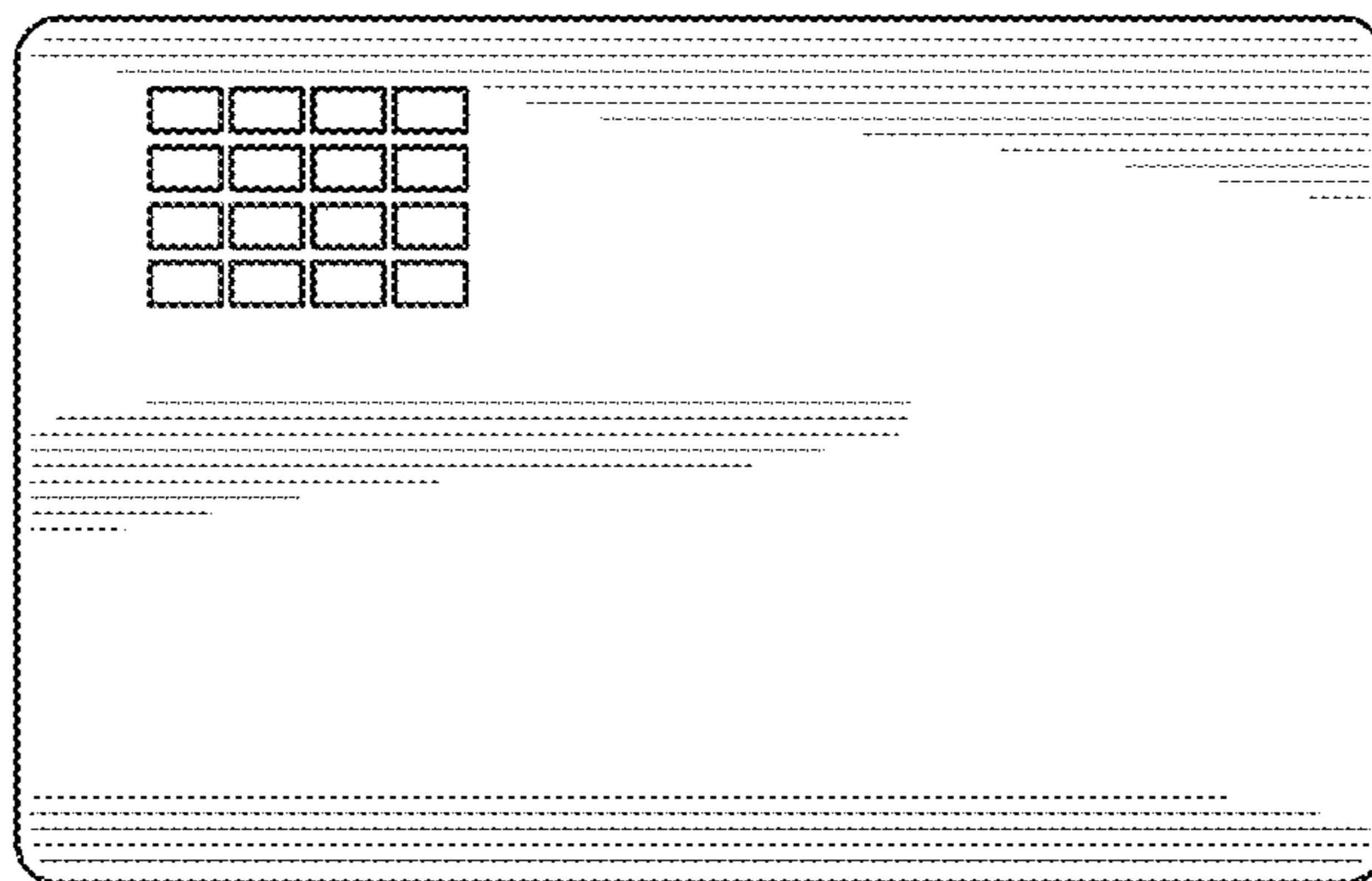

FIG. 192

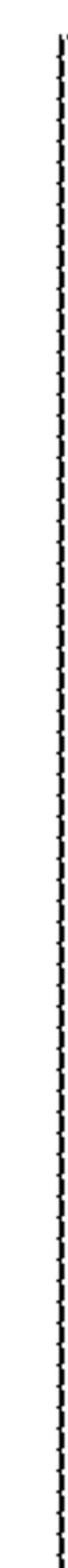

FIG. 196

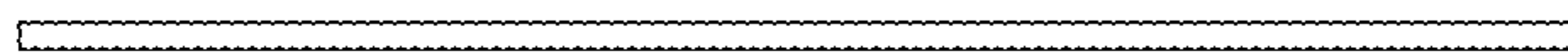

FIG. 194



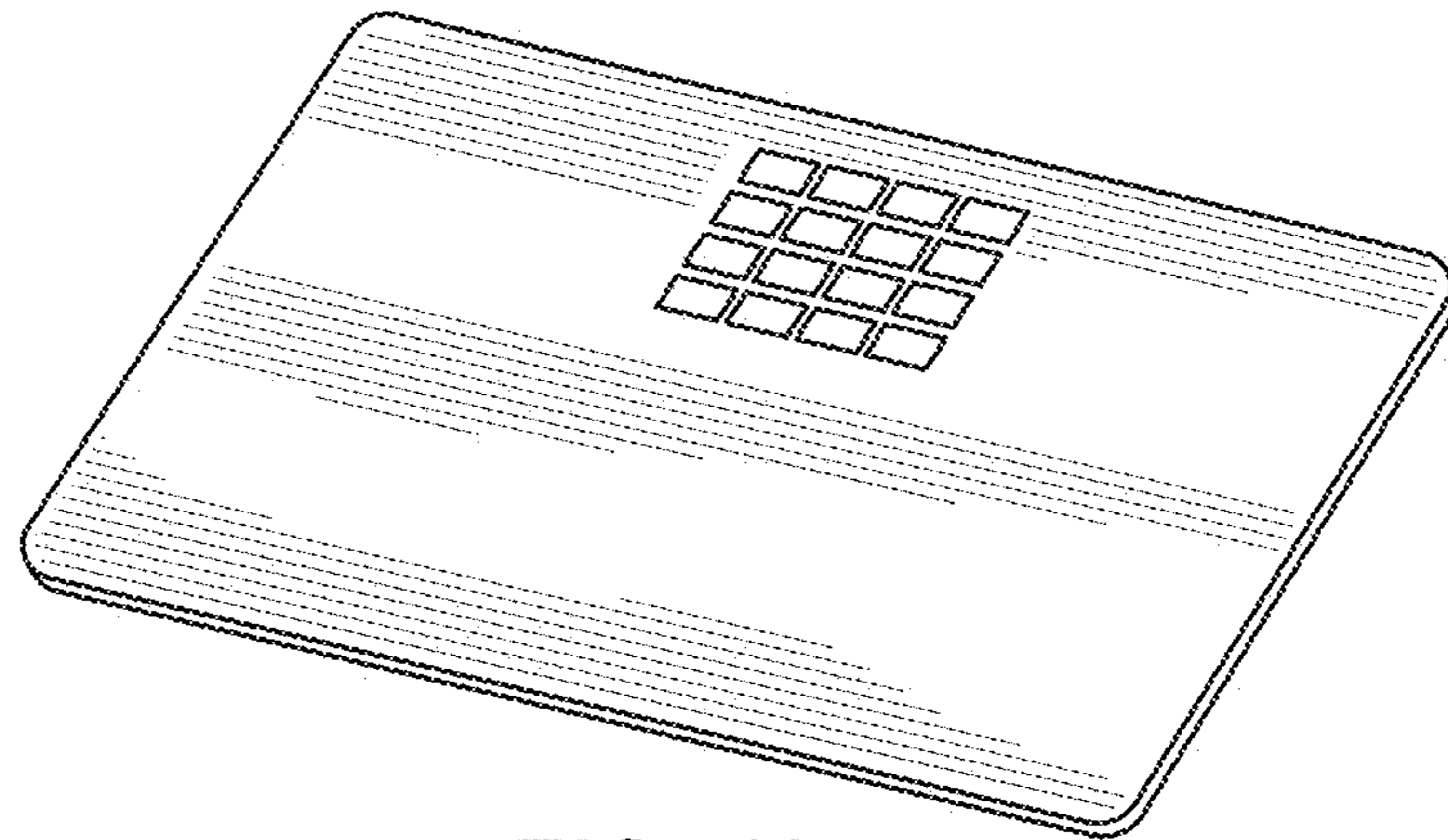

FIG. 197

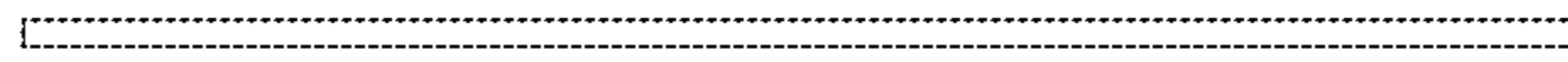

FIG. 200

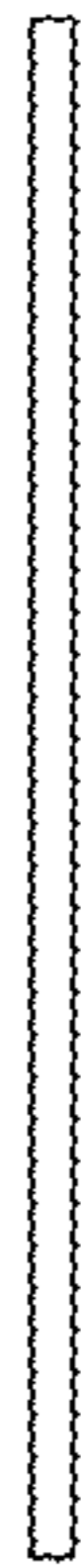

FIG. 202

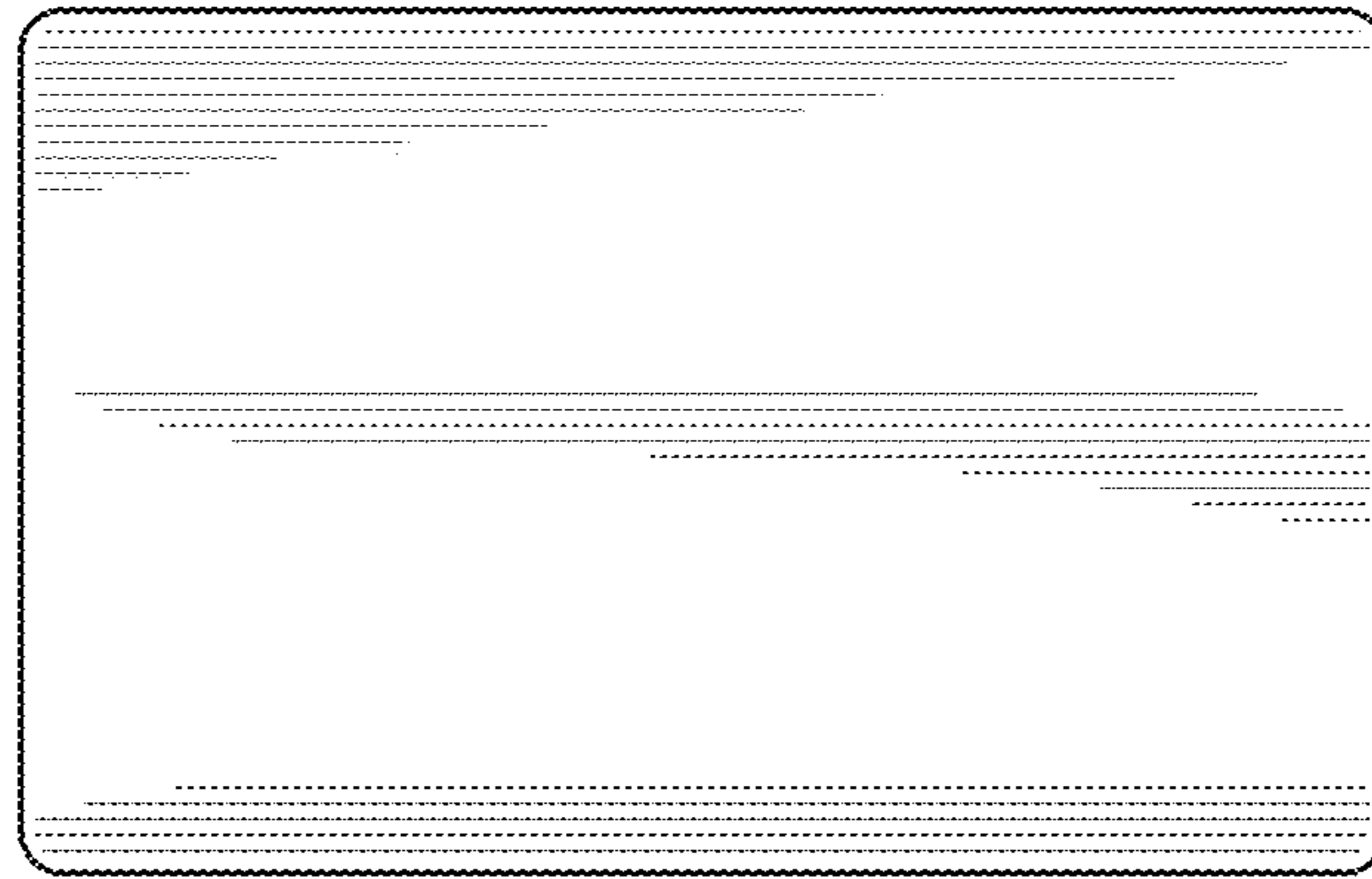

FIG. 198

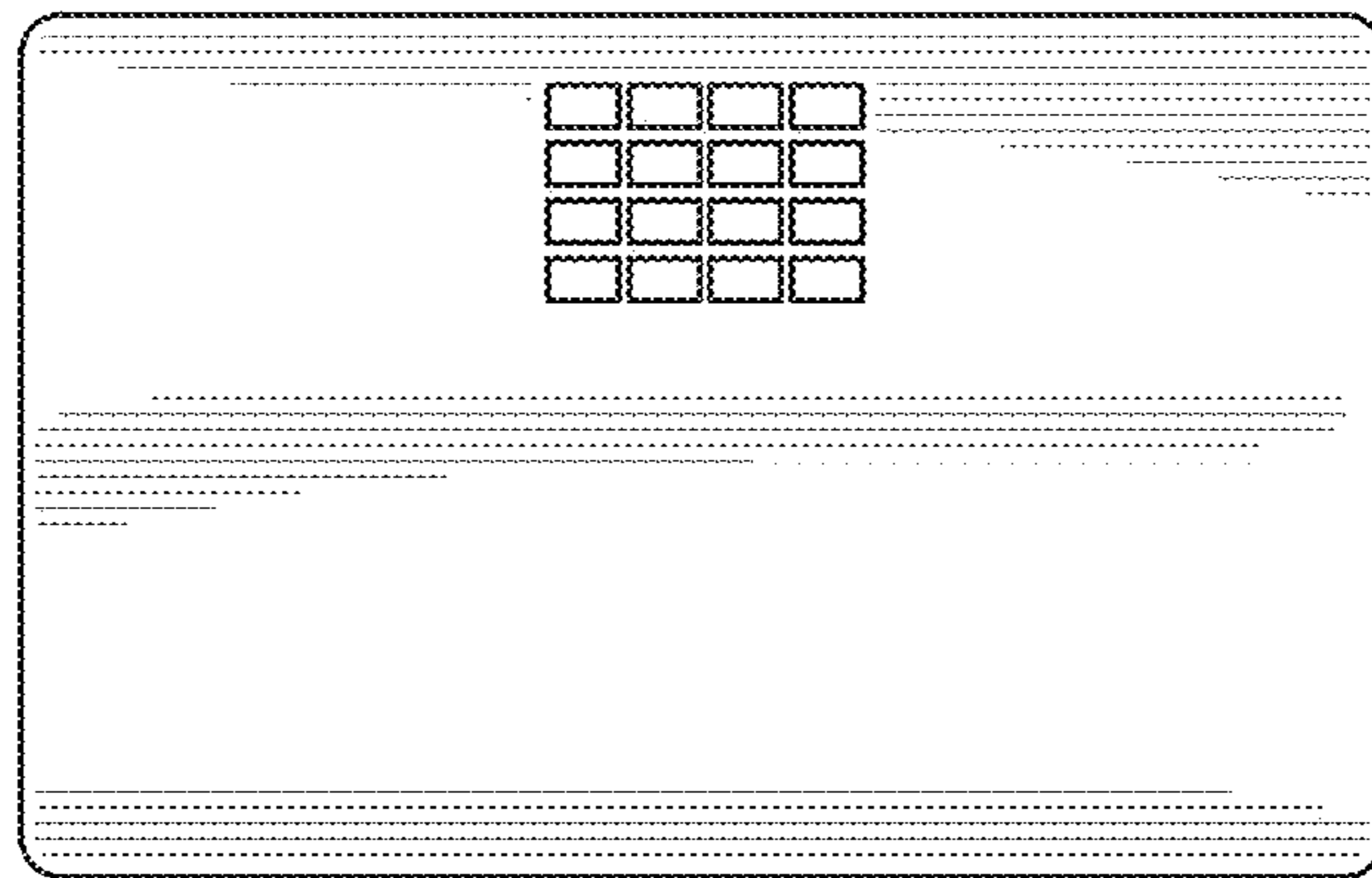

FIG. 199

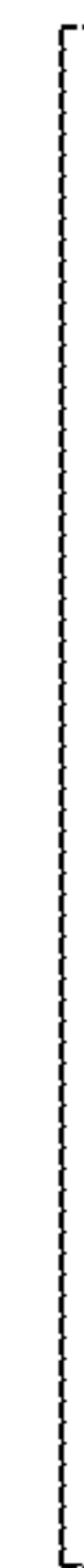

FIG. 203

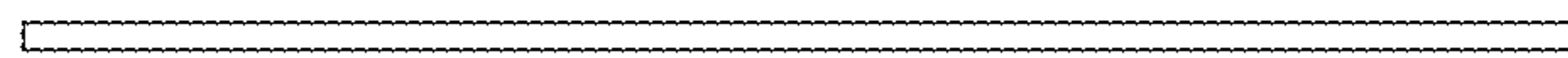

FIG. 201

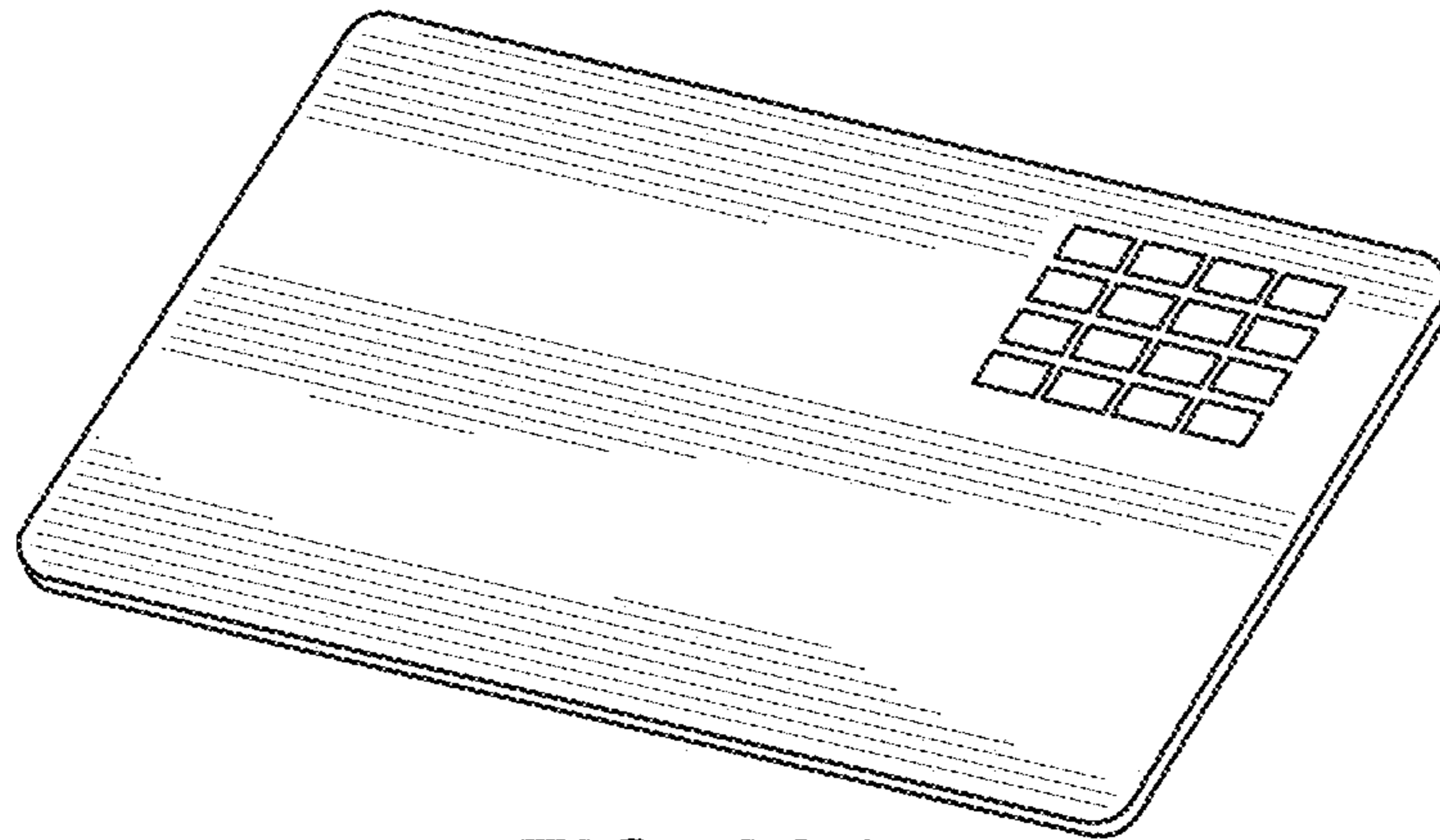

FIG. 204

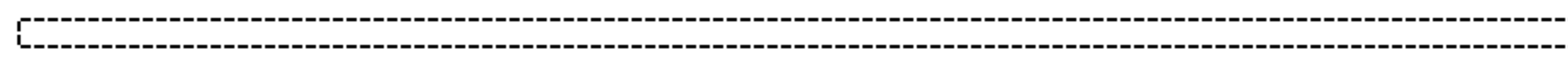

FIG. 207



FIG. 209

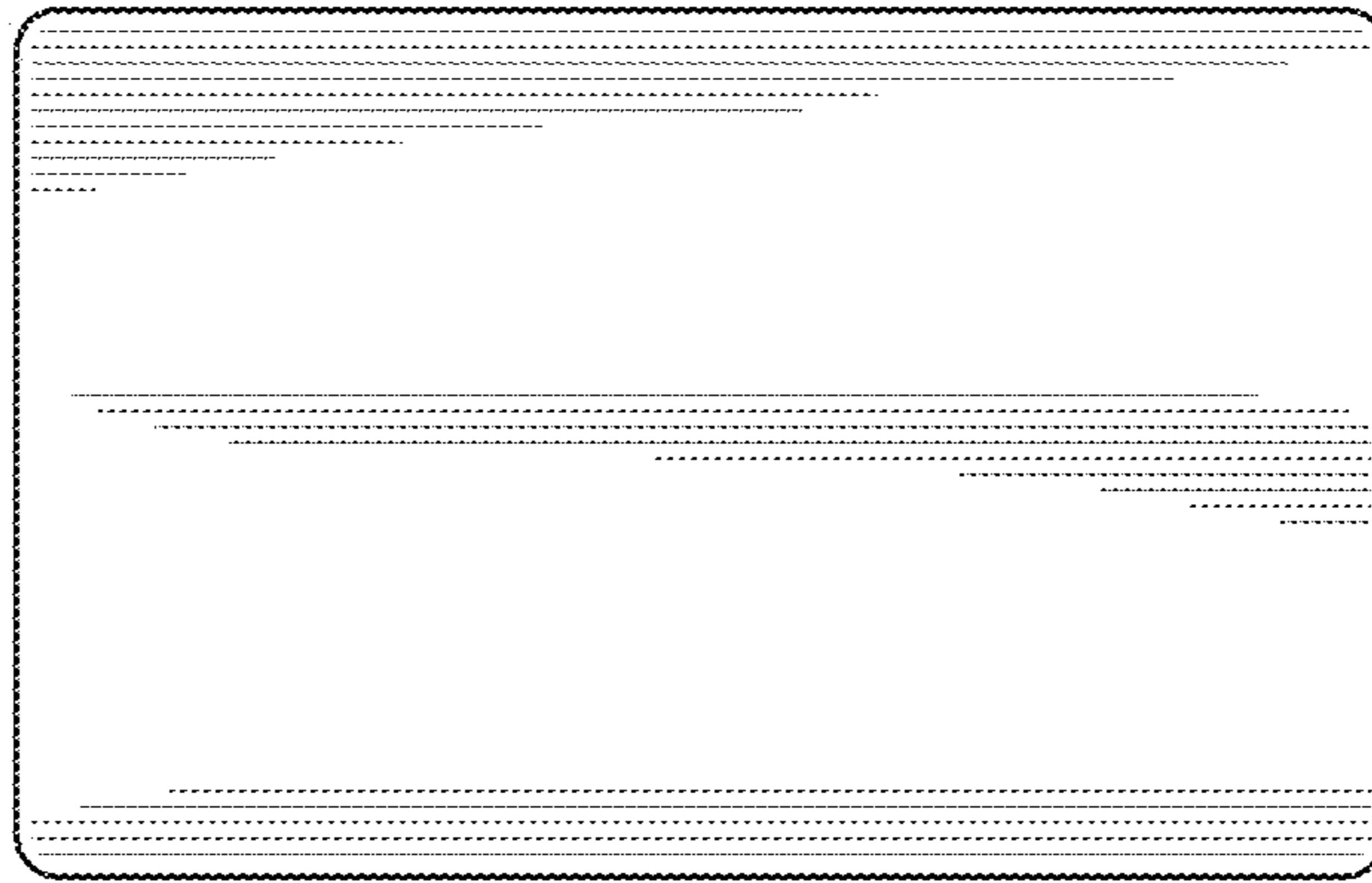

FIG. 205

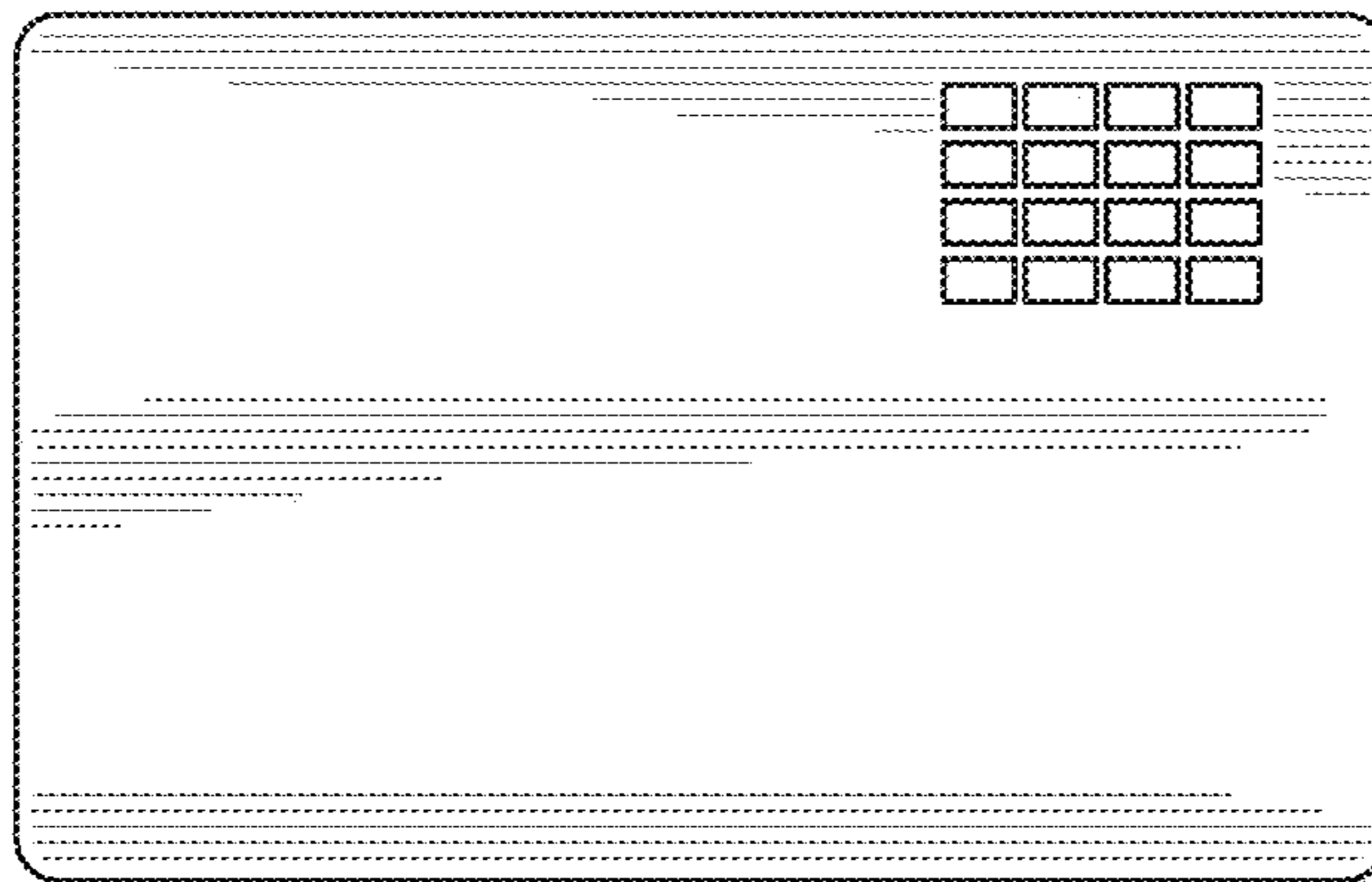

FIG. 206

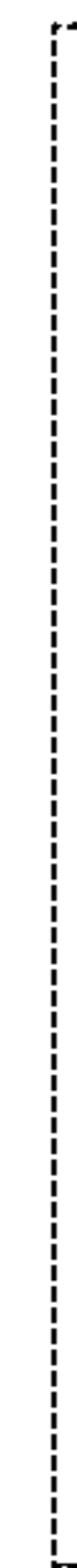

FIG. 210

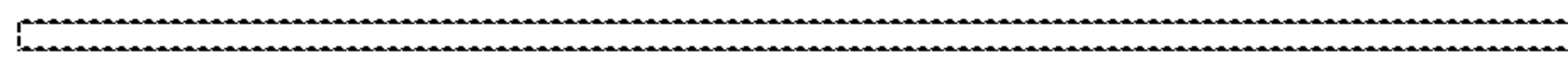

FIG. 208

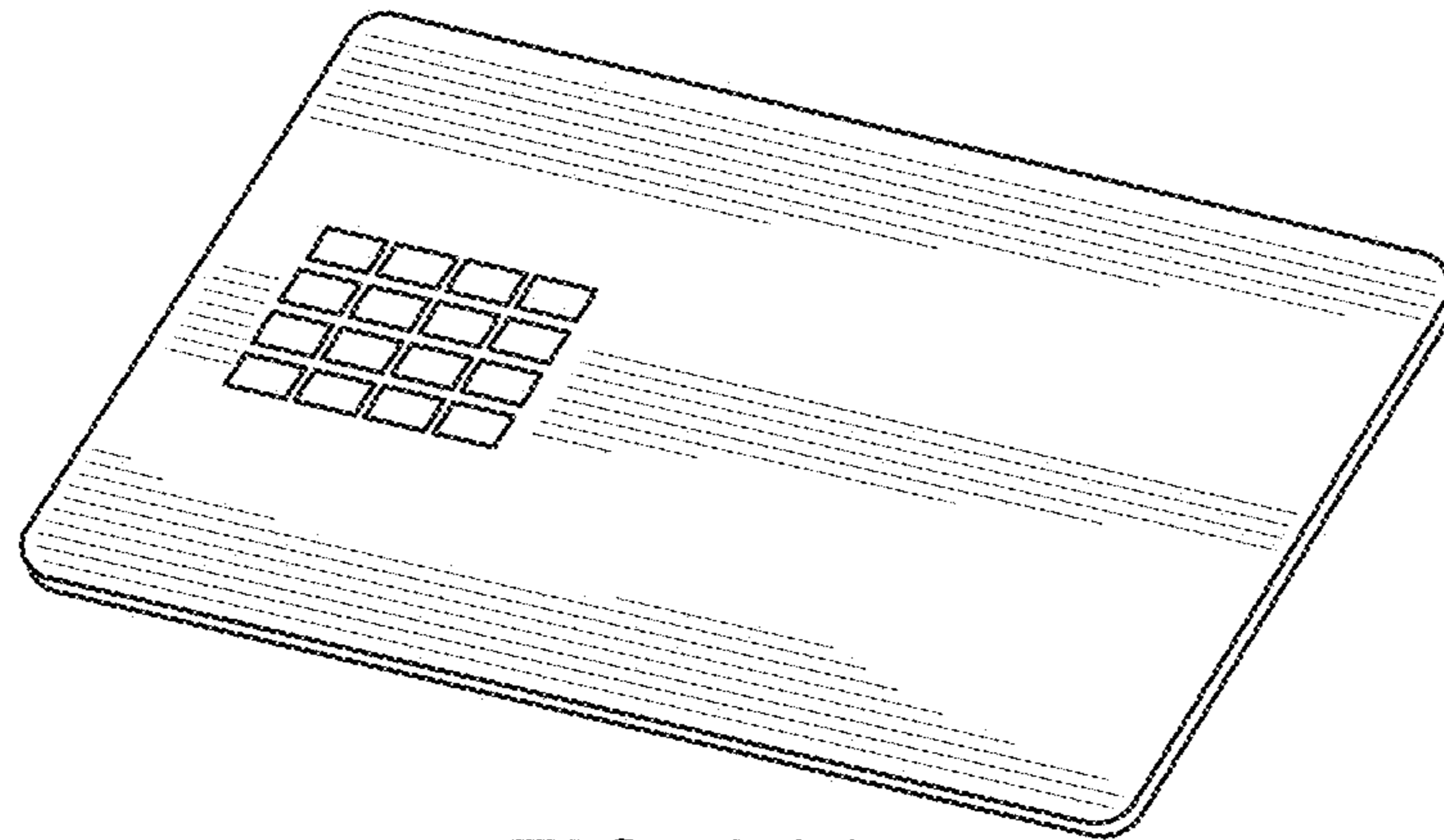

FIG. 211

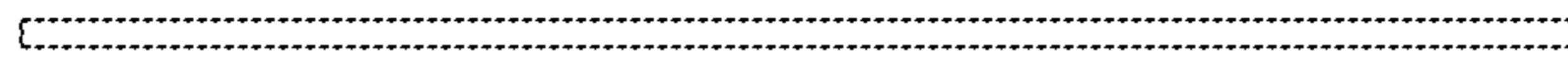

FIG. 214

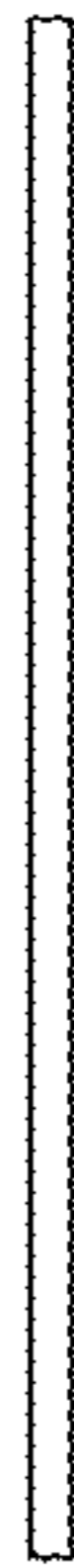

FIG. 216



FIG. 212

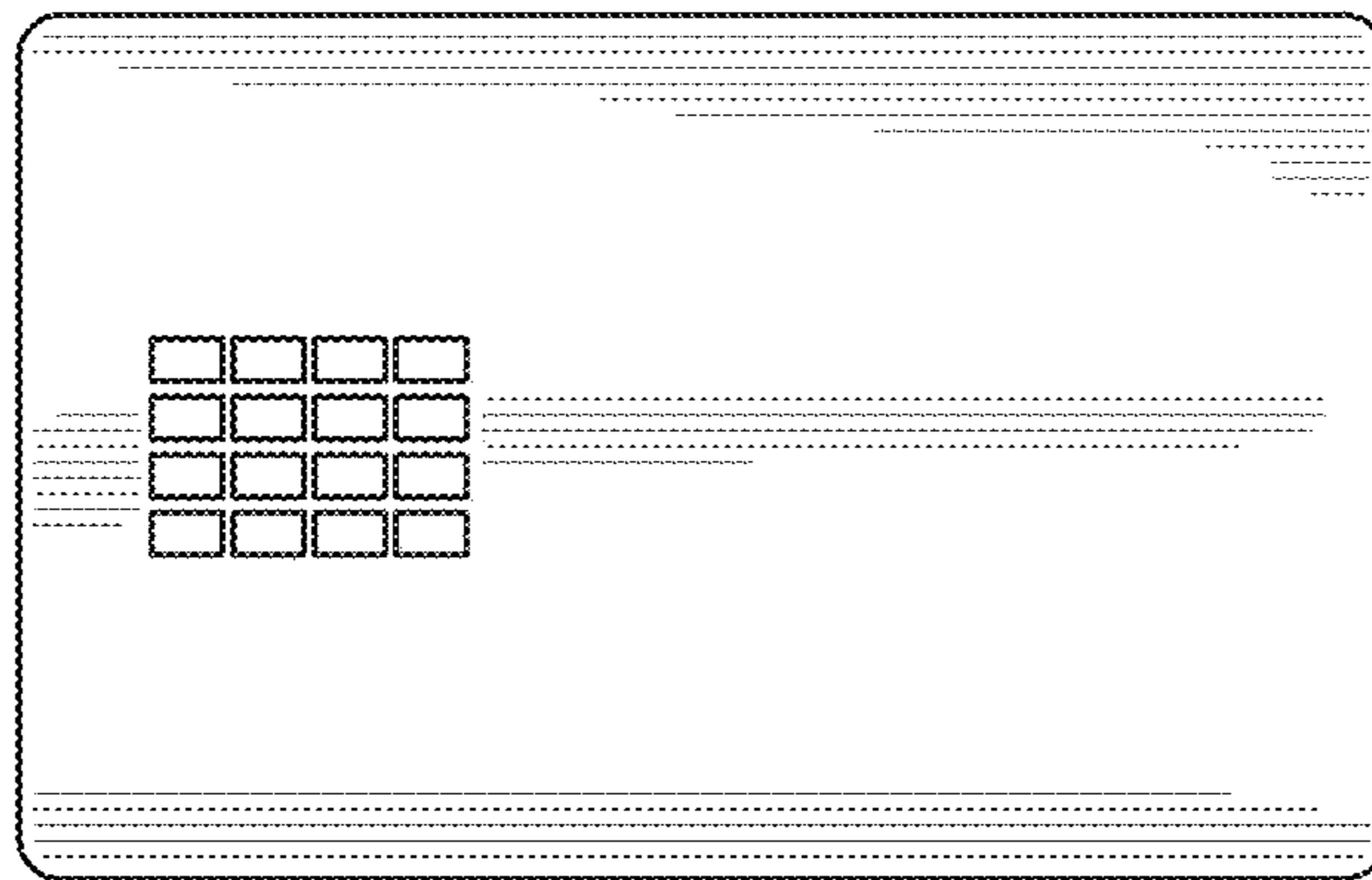

FIG. 213

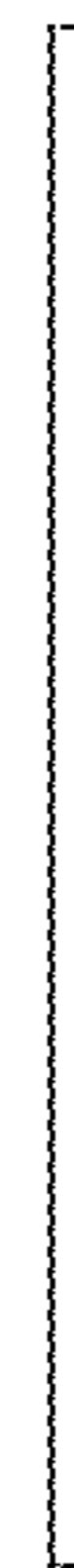

FIG. 217

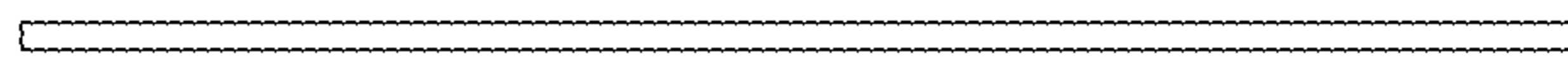

FIG. 215

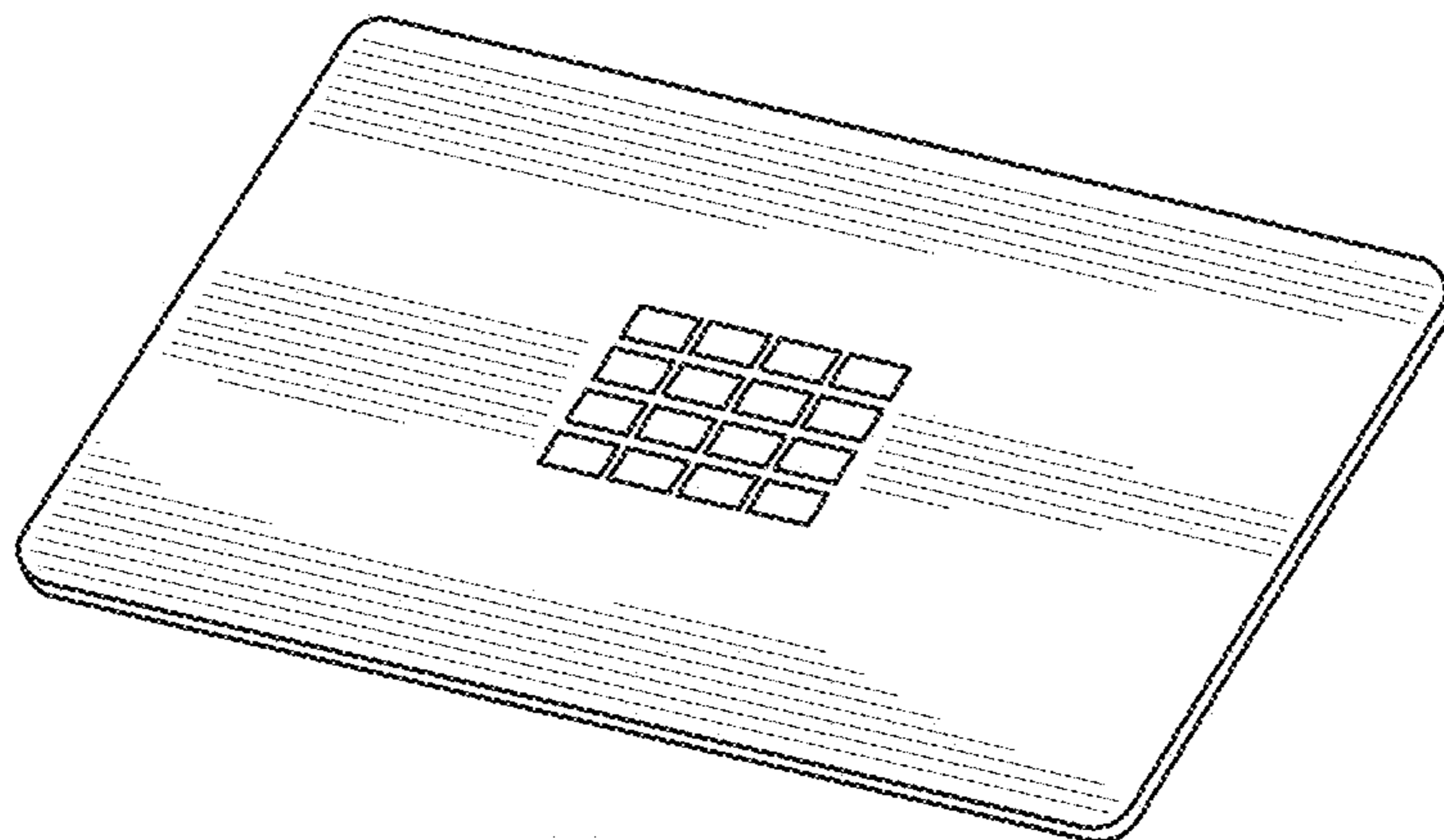

FIG. 218

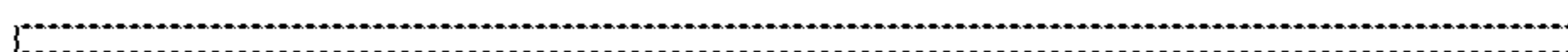

FIG. 221



FIG. 223



FIG. 219

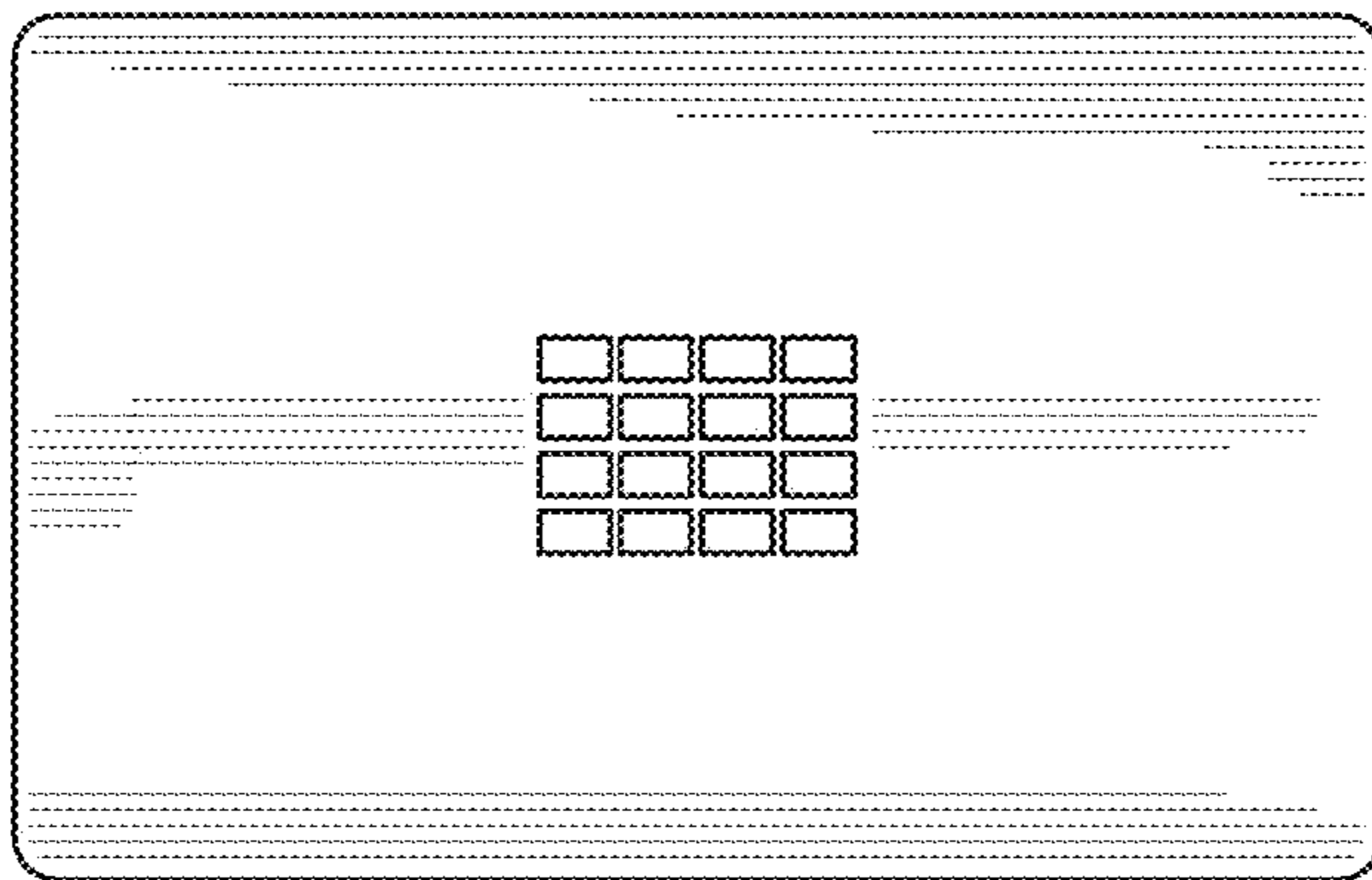

FIG. 220

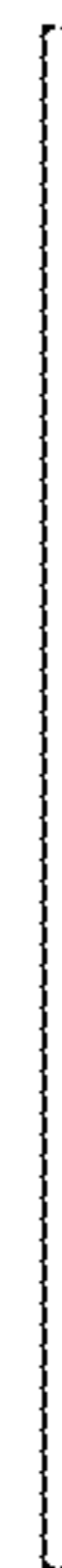

FIG. 224

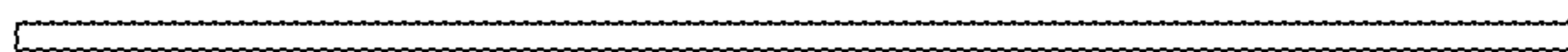

FIG. 222

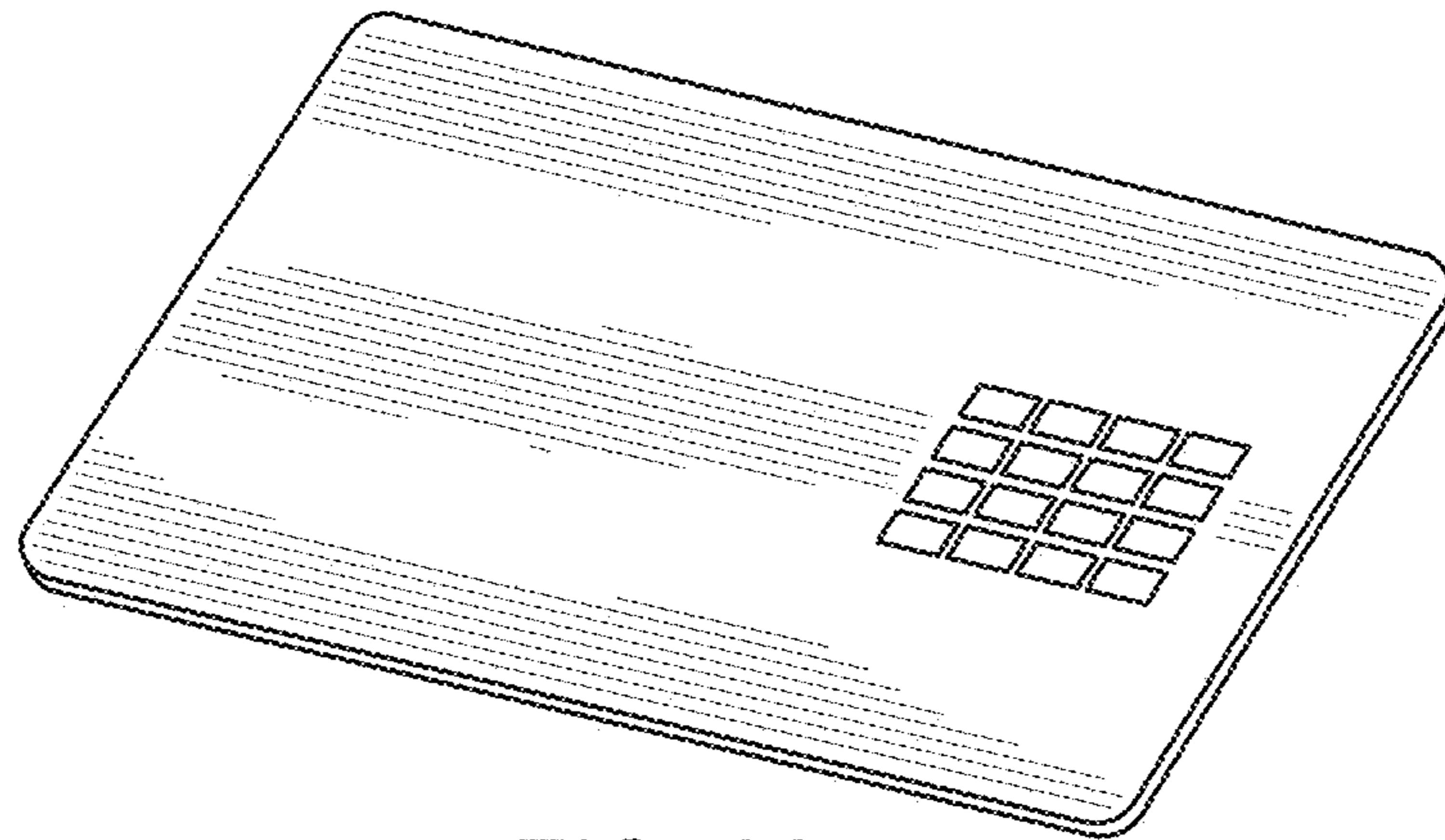

FIG. 225

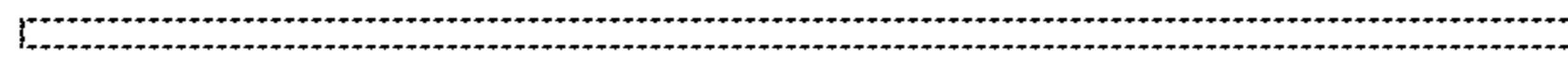

FIG. 228

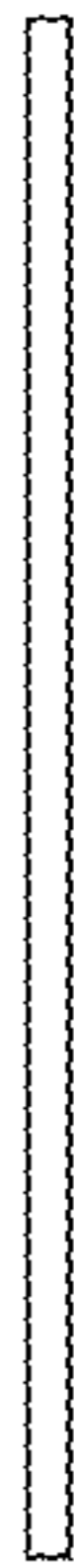

FIG. 230

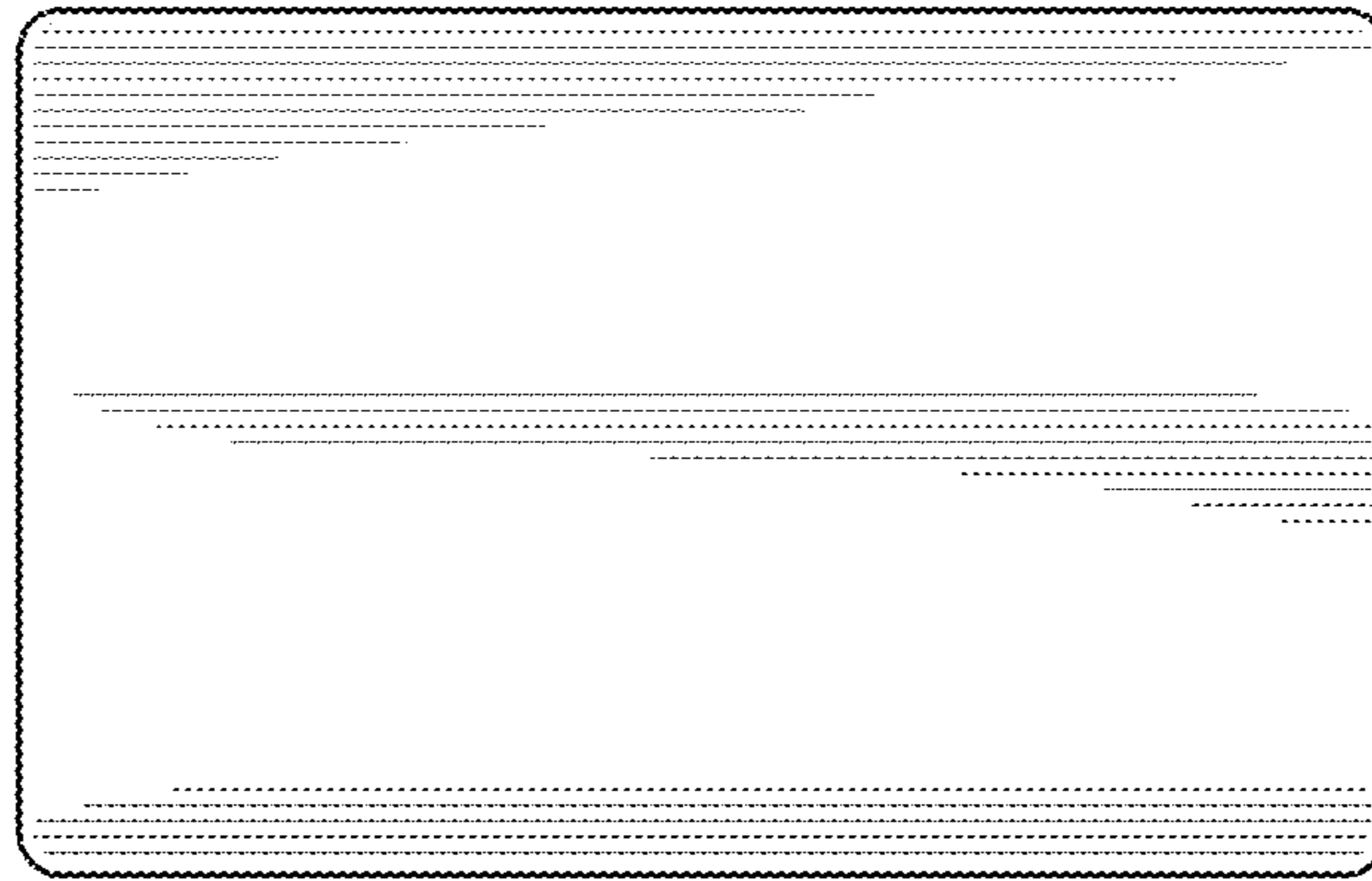

FIG. 226

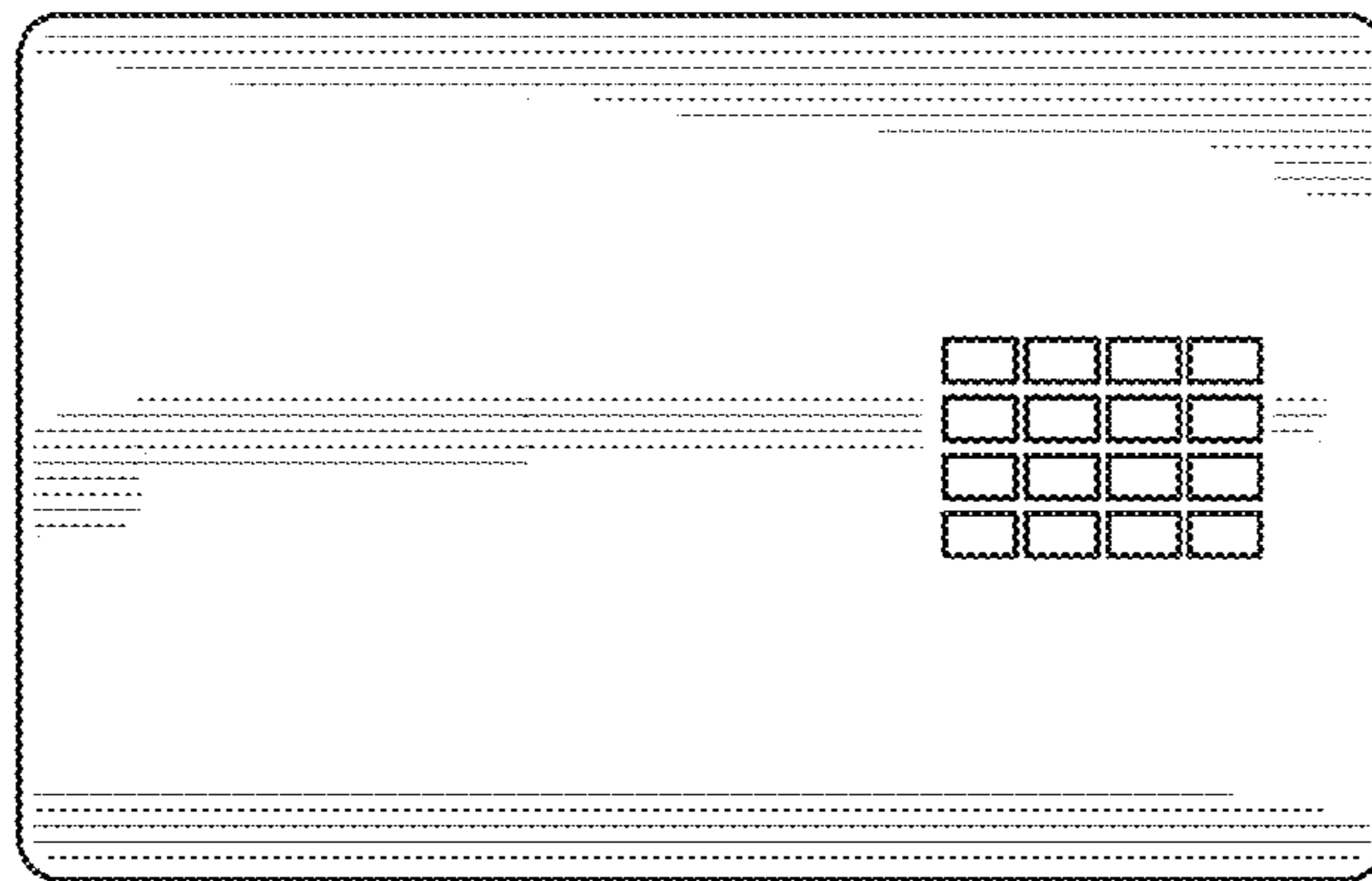

FIG. 227

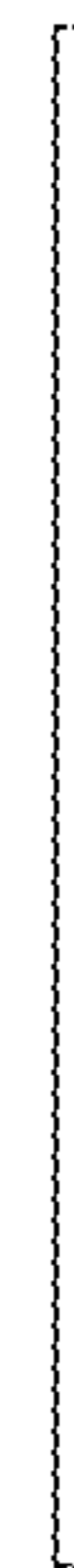

FIG. 231

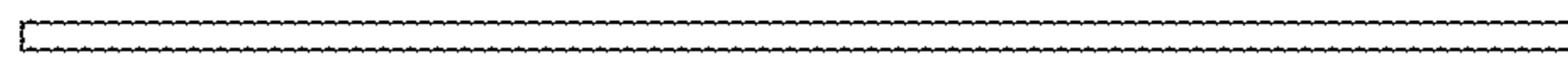

FIG. 229

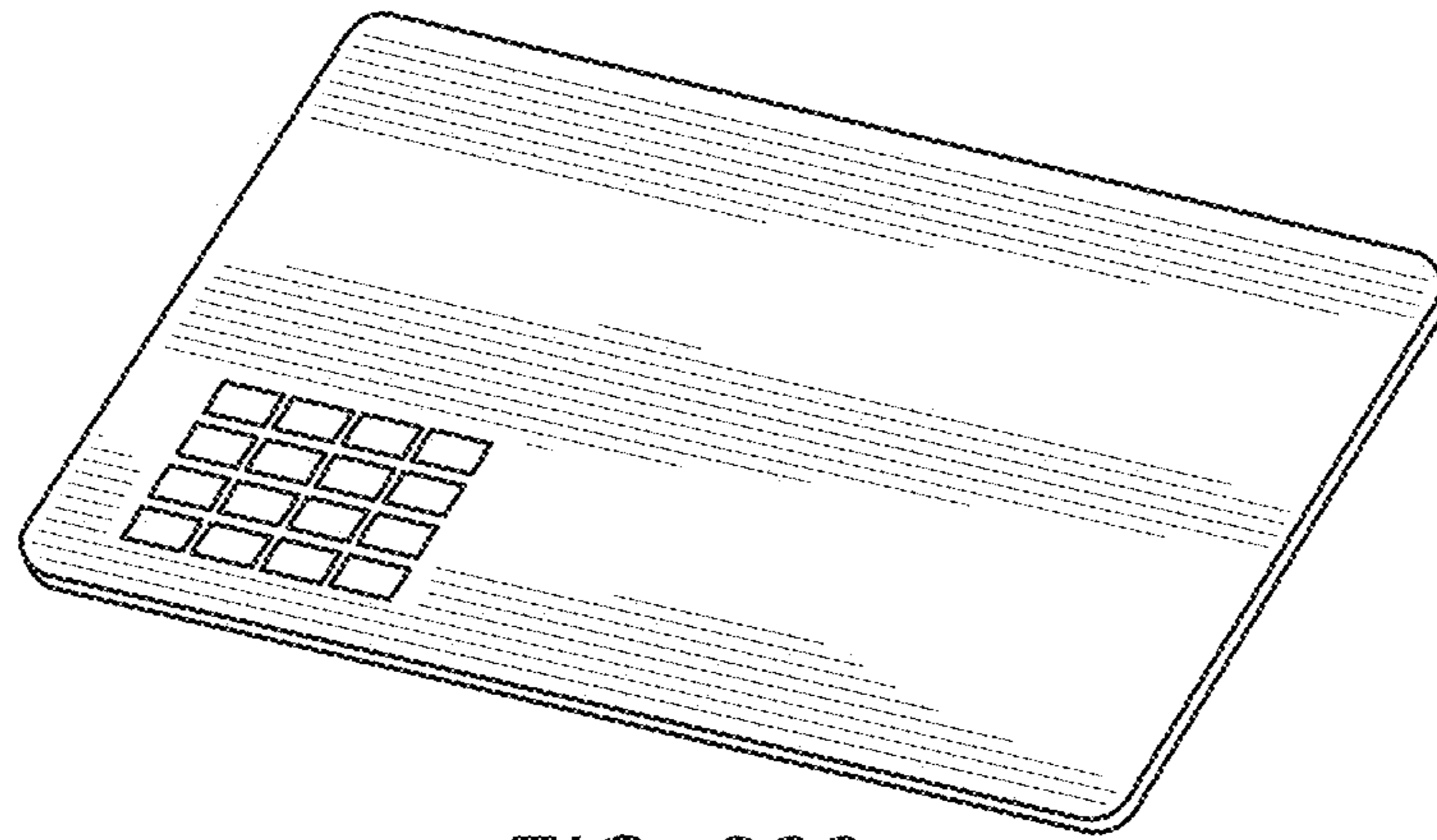

FIG. 232

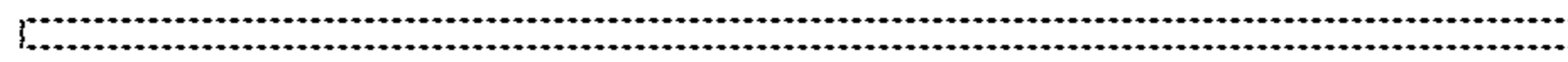

FIG. 235

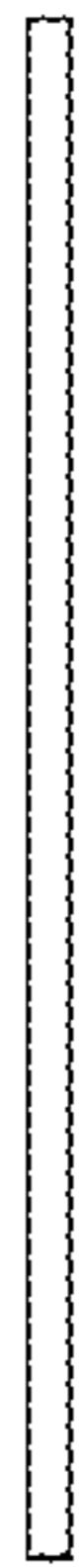

FIG. 237

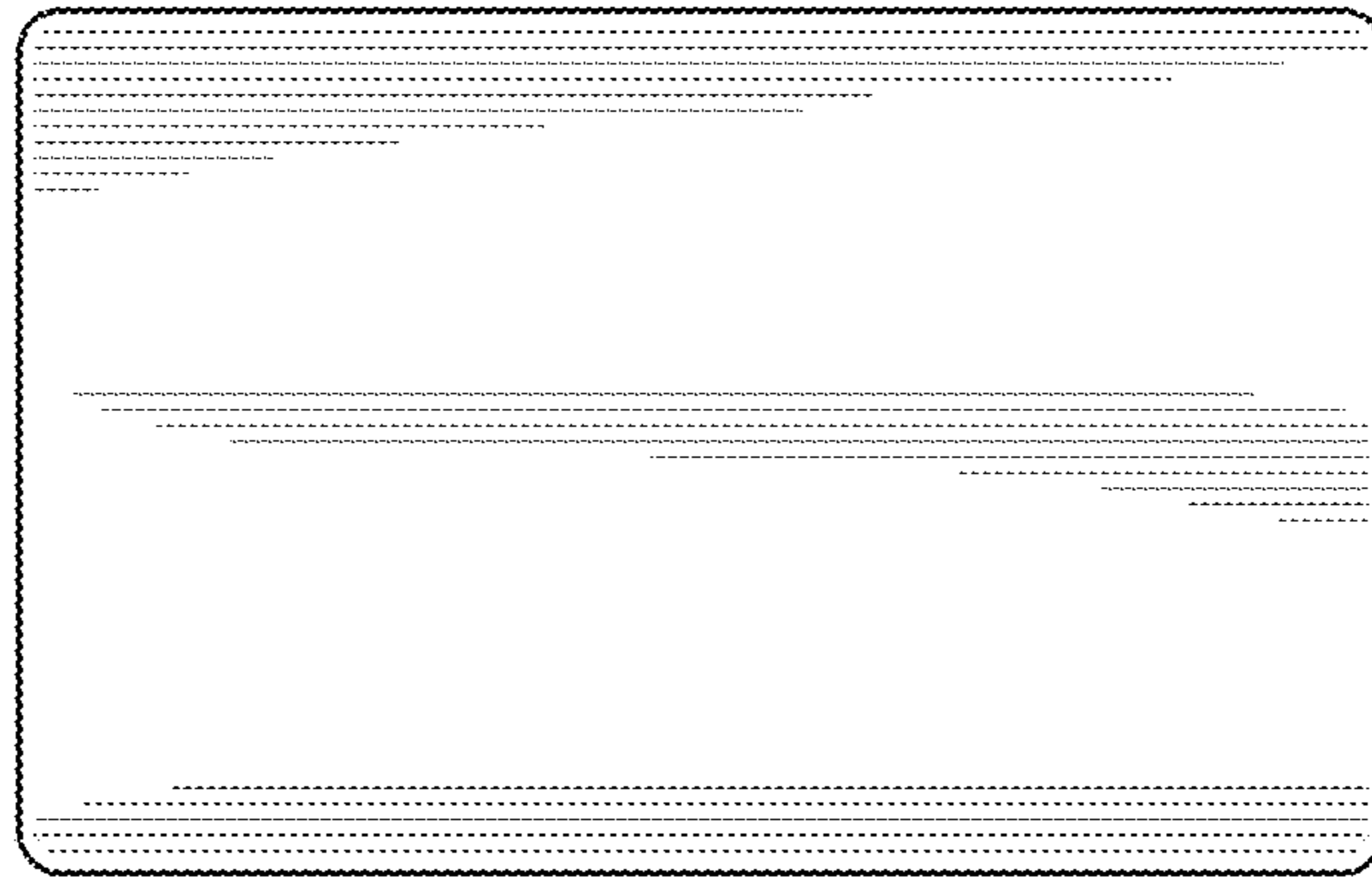

FIG. 233

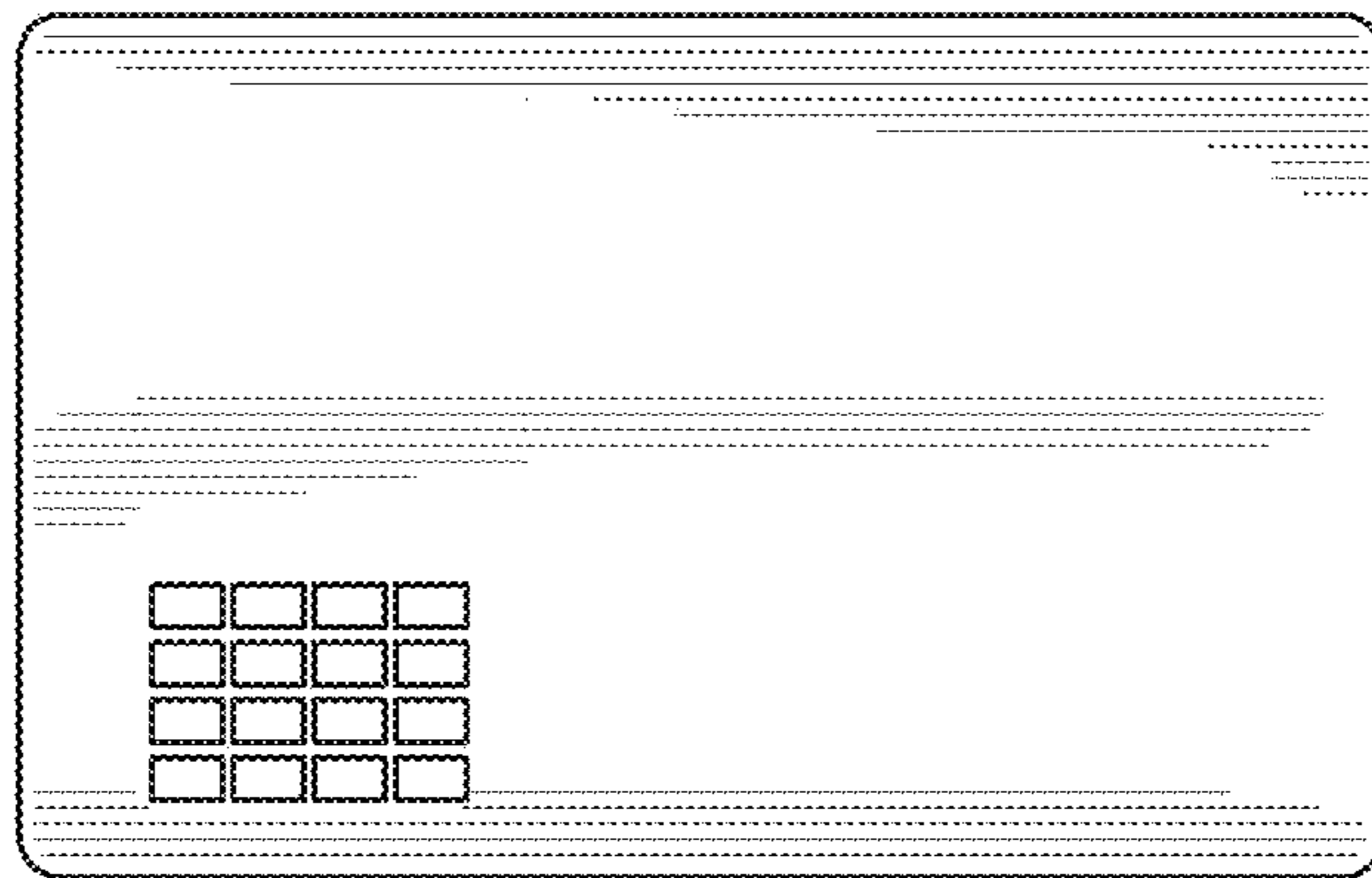

FIG. 234

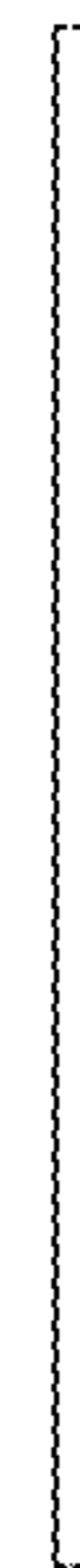

FIG. 238

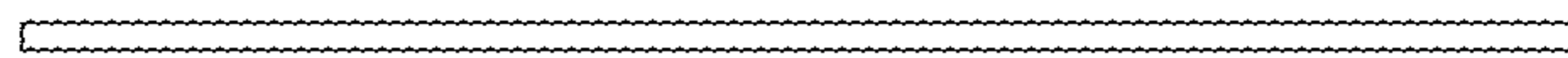

FIG. 236

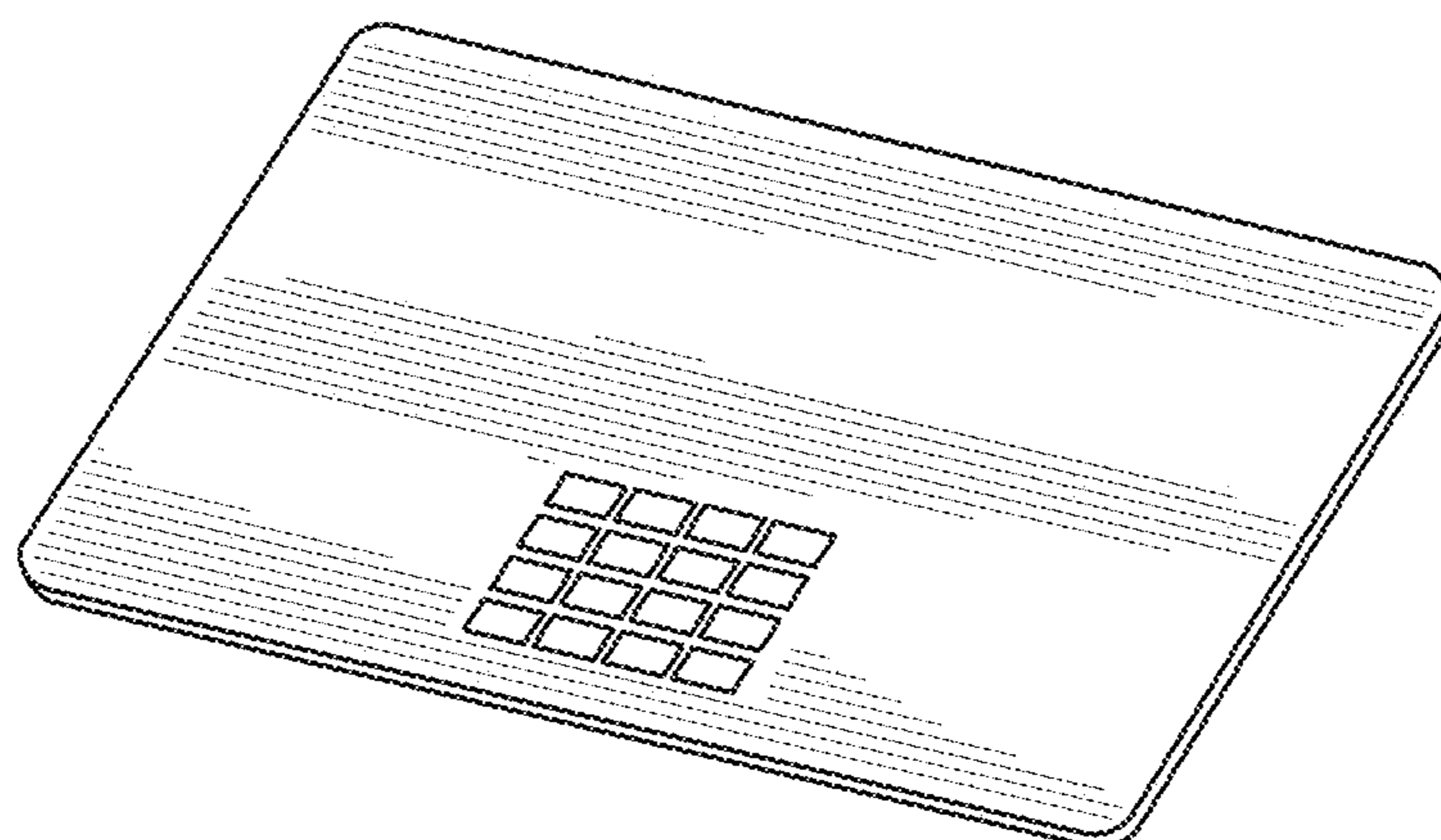

FIG. 239

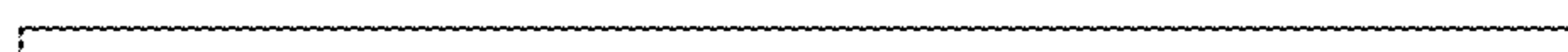

FIG. 242

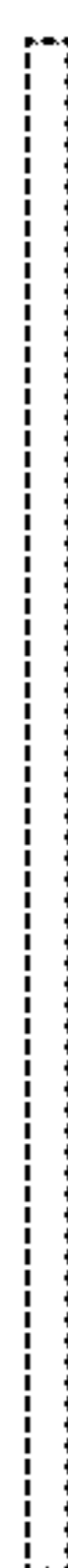

FIG. 244

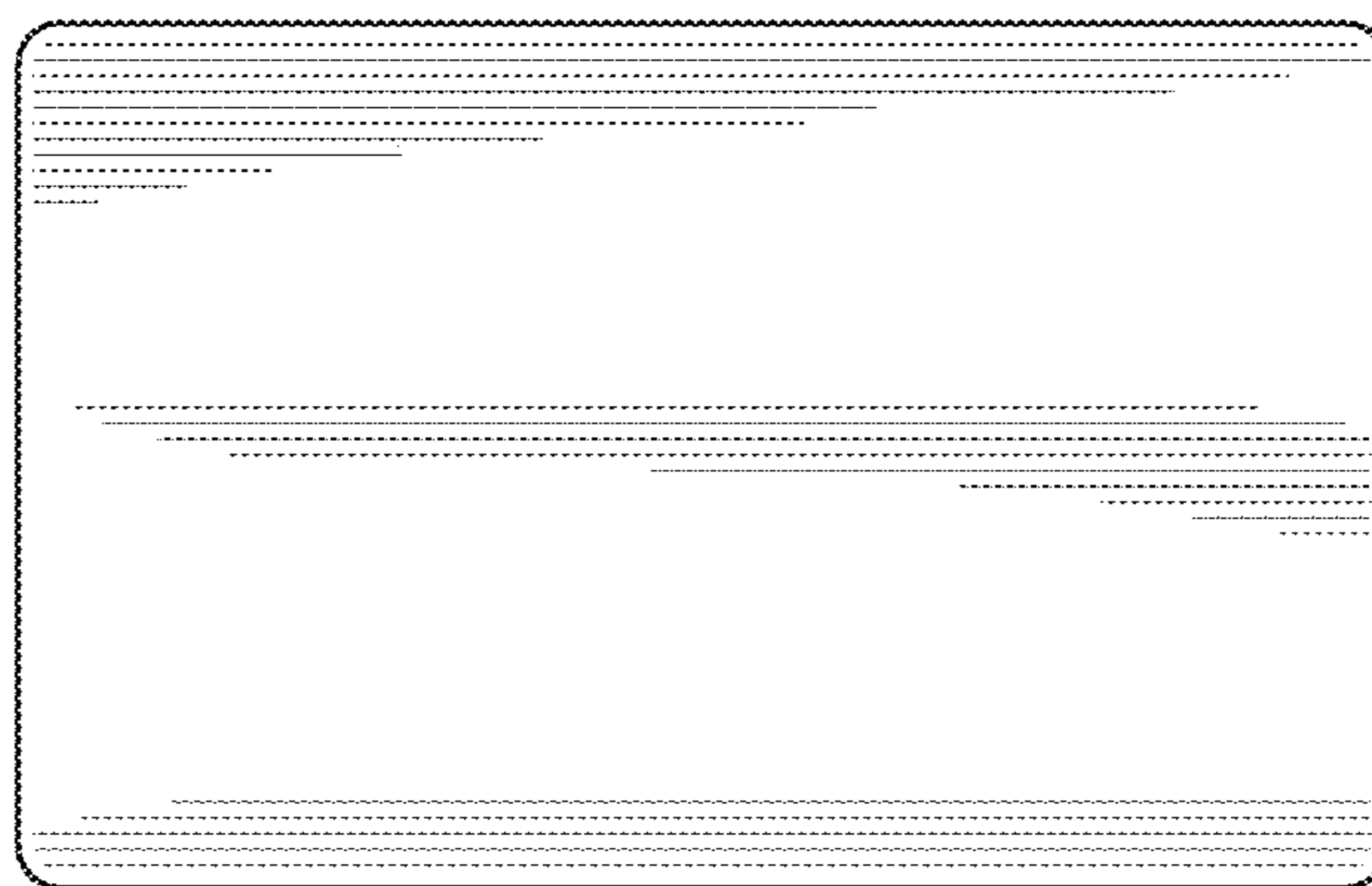

FIG. 240

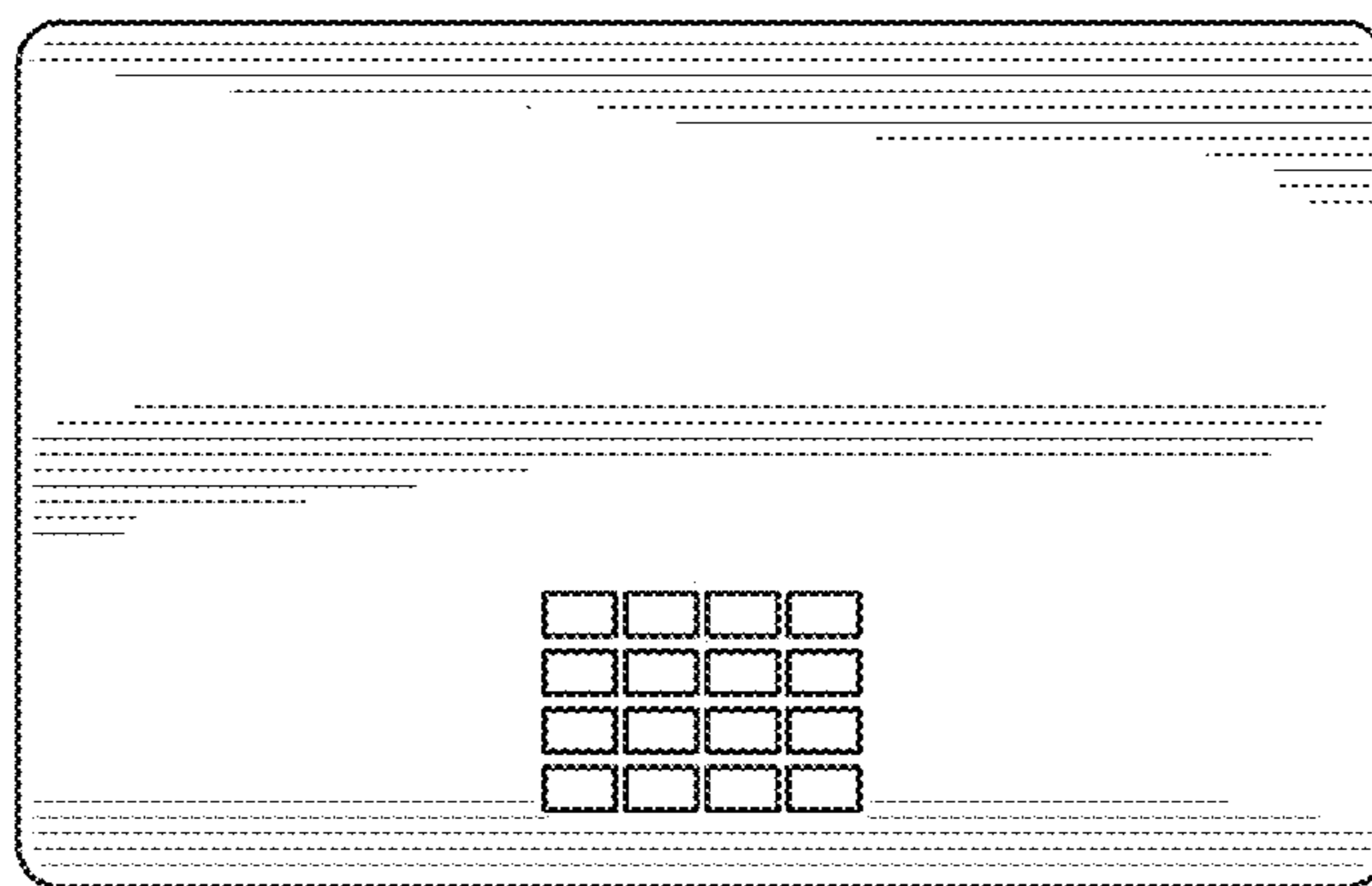

FIG. 241

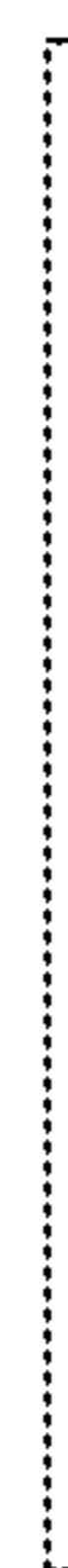

FIG. 245

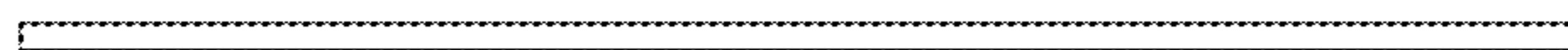

FIG. 243

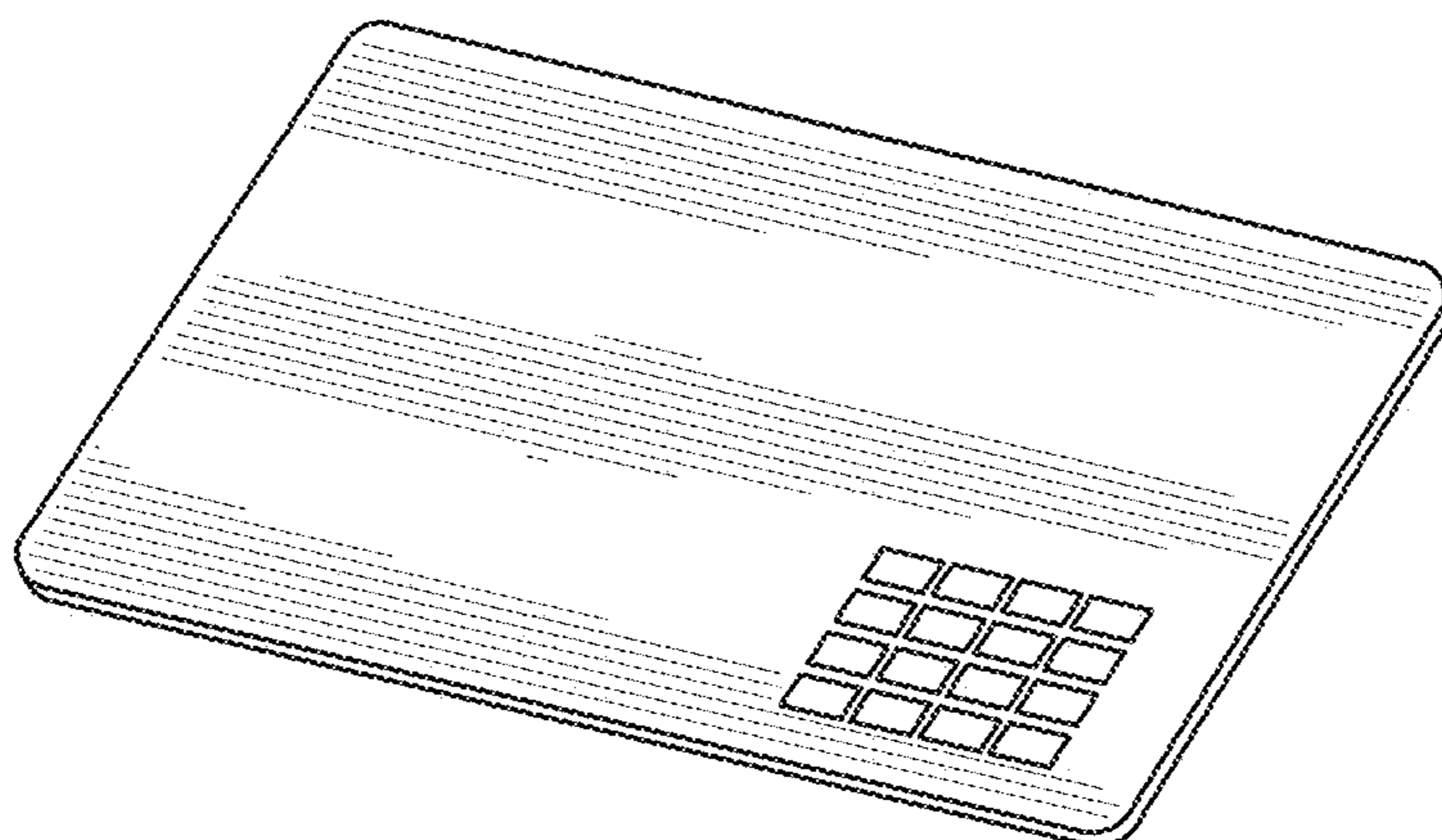

FIG. 246

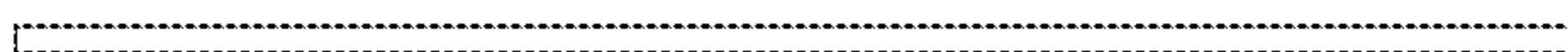

FIG. 249

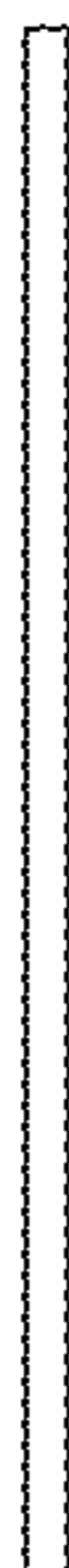

FIG. 251

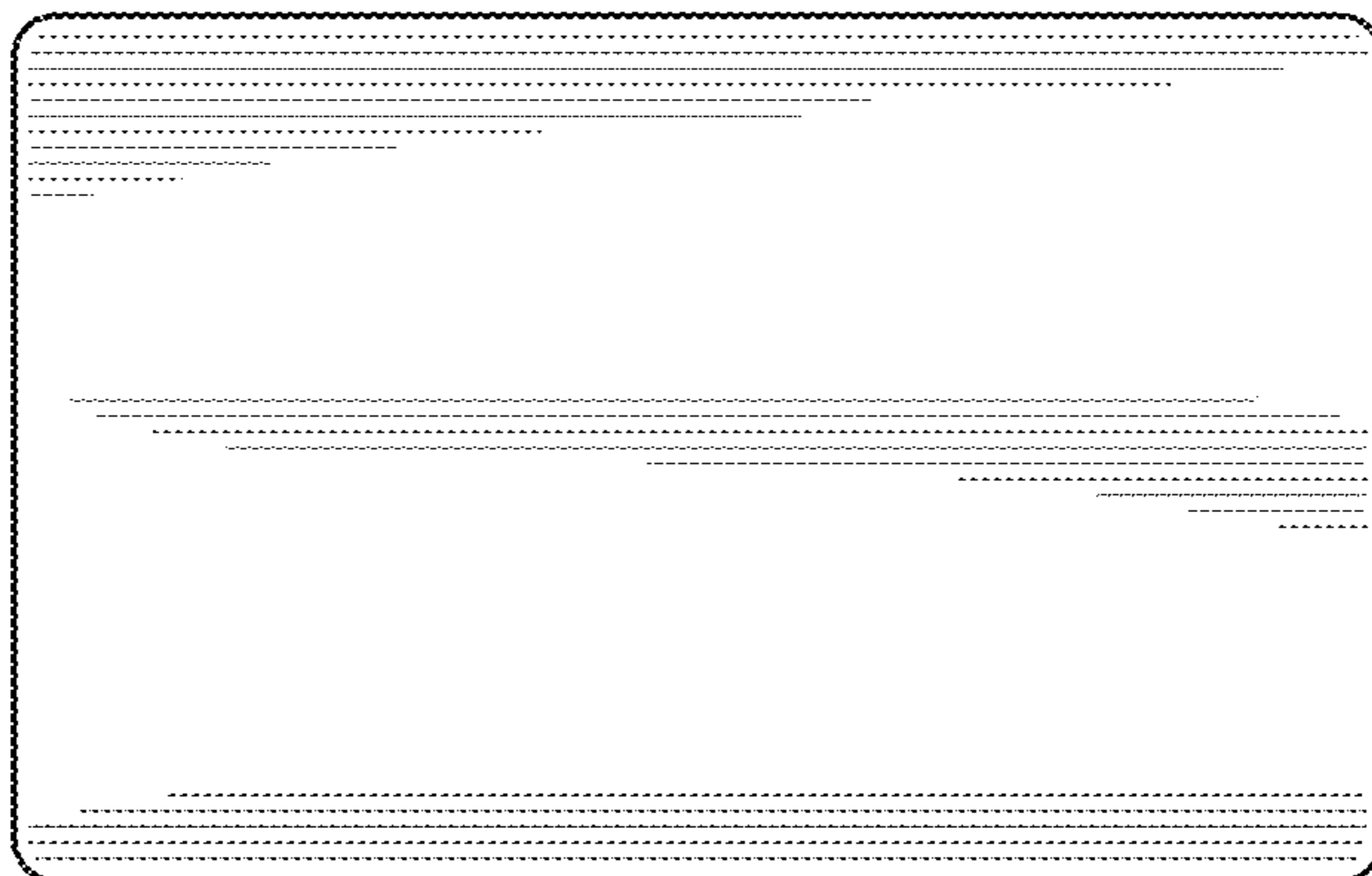

FIG. 247

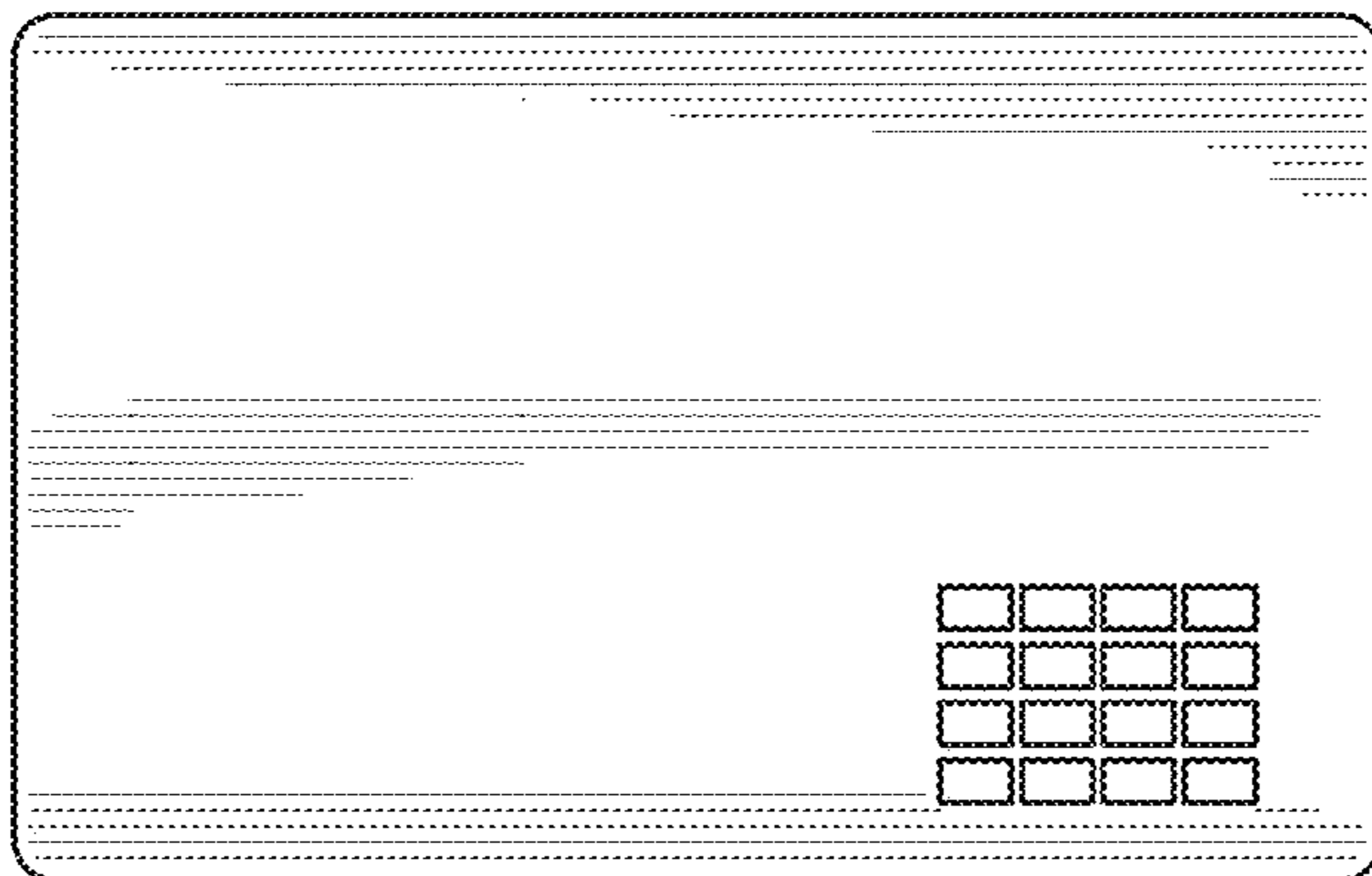

FIG. 248

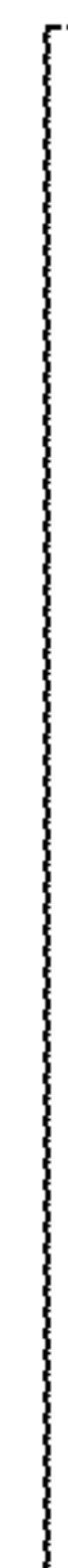

FIG. 252

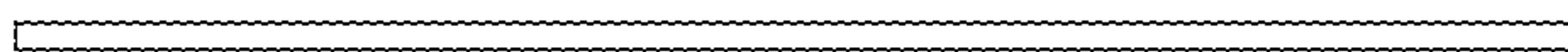

FIG. 250