

US00D921596S

(12) **United States Design Patent**  
**Altonen et al.**

(10) **Patent No.:** **US D921,596 S**

(45) **Date of Patent:** **\*\* \*Jun. 8, 2021**

- (54) **KEYPAD**
- (71) Applicant: **Lutron Technology Company LLC**,  
Coopersburg, PA (US)
- (72) Inventors: **Gregory S. Altonen**, Easton, PA (US);  
**Jason C. Killo**, Emmaus, PA (US);  
**Matthew P. McDonald**, Phoenixville,  
PA (US); **Sean Tucker**, Bethlehem, PA  
(US)
- (73) Assignee: **Lutron Technology Company LLC**,  
Coopersburg, PA (US)
- (\*) Notice: This patent is subject to a terminal dis-  
claimer.
- (\*\*) Term: **15 Years**

|              |      |         |                     |              |         |
|--------------|------|---------|---------------------|--------------|---------|
| 3,186,981    | A *  | 6/1965  | De Ronde .....      | H01H 9/286   | 200/318 |
| D360,235     | S *  | 7/1995  | Emrys-Roberts ..... | D14/401      |         |
| 5,834,695    | A    | 11/1998 | Herbert             |              |         |
| D433,954     | S *  | 11/2000 | Delsart .....       | D10/108      |         |
| D453,742     | S *  | 2/2002  | Butler .....        | D13/164      |         |
| D510,074     | S *  | 9/2005  | Larson .....        | D13/164      |         |
| D547,273     | S *  | 7/2007  | Mierta .....        | D13/164      |         |
| D573,956     | S *  | 7/2008  | Hollner .....       | D13/164      |         |
| D595,240     | S *  | 6/2009  | Busbridge .....     | D13/164      |         |
| D621,795     | S *  | 8/2010  | Tsui .....          | D13/171      |         |
| D635,102     | S *  | 3/2011  | Tsui .....          | D13/171      |         |
| D652,087     | S *  | 1/2012  | Dawes .....         | D21/489      |         |
| D663,700     | S *  | 7/2012  | Deal .....          | D13/162      |         |
| 8,786,196    | B2   | 7/2014  | Biery et al.        |              |         |
| D777,688     | S *  | 1/2017  | Seidl .....         | D13/171      |         |
| 2010/0059351 | A1 * | 3/2010  | Wu .....            | A47B 13/12   | 200/341 |
| 2010/0270138 | A1 * | 10/2010 | Yamanaka .....      | H01H 13/7057 | 200/341 |

- (21) Appl. No.: **29/634,284**
- (22) Filed: **Jan. 19, 2018**
- (51) **LOC (13) Cl.** ..... **13-03**
- (52) **U.S. Cl.**  
USPC ..... **D13/164**
- (58) **Field of Classification Search**  
USPC ..... D13/162, 164, 171, 177  
CPC .. H01H 3/12; H01H 9/02; H01H 9/16; H01H  
9/18; H01H 9/181; H01H 9/182; H01H  
13/04; H01H 13/14; H01H 2009/187;  
H05B 37/02; H05B 37/0254; H05B  
37/0272; H05B 39/02; H05B 39/04;  
H05B 39/085; H05B 39/086; H05B  
39/088  
See application file for complete search history.

**OTHER PUBLICATIONS**

Knightsbridge Catalogue, Lighting and Wiring Accessories, 2015, p. 8, 36; [https://issuu.com/mlaccessorieslimited/docs/2015\\_mla\\_catalogue](https://issuu.com/mlaccessorieslimited/docs/2015_mla_catalogue).\*

RetroTouch 4 Gang 2 way Dimmer CT 02100; <https://www.lightswitchesandplugsockets.co.uk/retrotouch-4-gang-2-way-dimmer-switch-3-200w-led-halogen-white-glass-ct-02100-4720-p.asp>.\*

<http://www.legrand.com.vn/mallia/downloads/mallia.pdf>, 2010, 30 pages.\*

Clipsal 4061 PBLHB; Mar. 31, 2014; 1 pg; <https://www.bing.com/videos/search?q=saturn+horizon+switch&&view-detail&mid-29784129A37E9021BA0629784129A37E9021BA06&&FORM=VRD GAR&ru=%2Fvideos%2Fsearch%3Fq%3Dsaturn%2Bhorizon%2Bswitch%26%26FORM%3DVDV VXX>.

Clipsal 4063PB Push Button Switch; before 2017; 1 pg.

Topshall Illuminated Wall Mount Push Switch; before 2017; 1 pg; [https://www.google.com/search?hl=en&biw=1536&bih=813&tbm=isch&sa=1&ei=Op-fXblwa5qSCB9e7oIAO&q=push+button+dimmer+switch+before+2017&oq=push+button+dimmer+switch+before+2017&gs\\_l=img.3...3379.7032..8742...0.0.0.67.630.12.....0....1.gws-wiz-img](https://www.google.com/search?hl=en&biw=1536&bih=813&tbm=isch&sa=1&ei=Op-fXblwa5qSCB9e7oIAO&q=push+button+dimmer+switch+before+2017&oq=push+button+dimmer+switch+before+2017&gs_l=img.3...3379.7032..8742...0.0.0.67.630.12.....0....1.gws-wiz-img).

Varilight-Catalogue; <https://www.variliht.co.uk/varilight-catalogue.pdf>.

LEGRAND®, Mallia™ Catalogue, “Look Touch Love Woo,” Apr. 2010 (26 pages).

Arnould, Art d’Arnould Brochure (English version), Apr. 2011 (52 pages).

Meljac, Catalogue 2014 (108 pages).

- (56) **References Cited**  
U.S. PATENT DOCUMENTS
- 1,796,226 A \* 3/1931 Tombler ..... H02G 3/14  
16/DIG. 2
- 2,215,260 A \* 9/1940 Woodward ..... H01H 9/161  
248/27.3
- 3,185,803 A \* 5/1965 Driscoll ..... H01H 13/12  
200/296

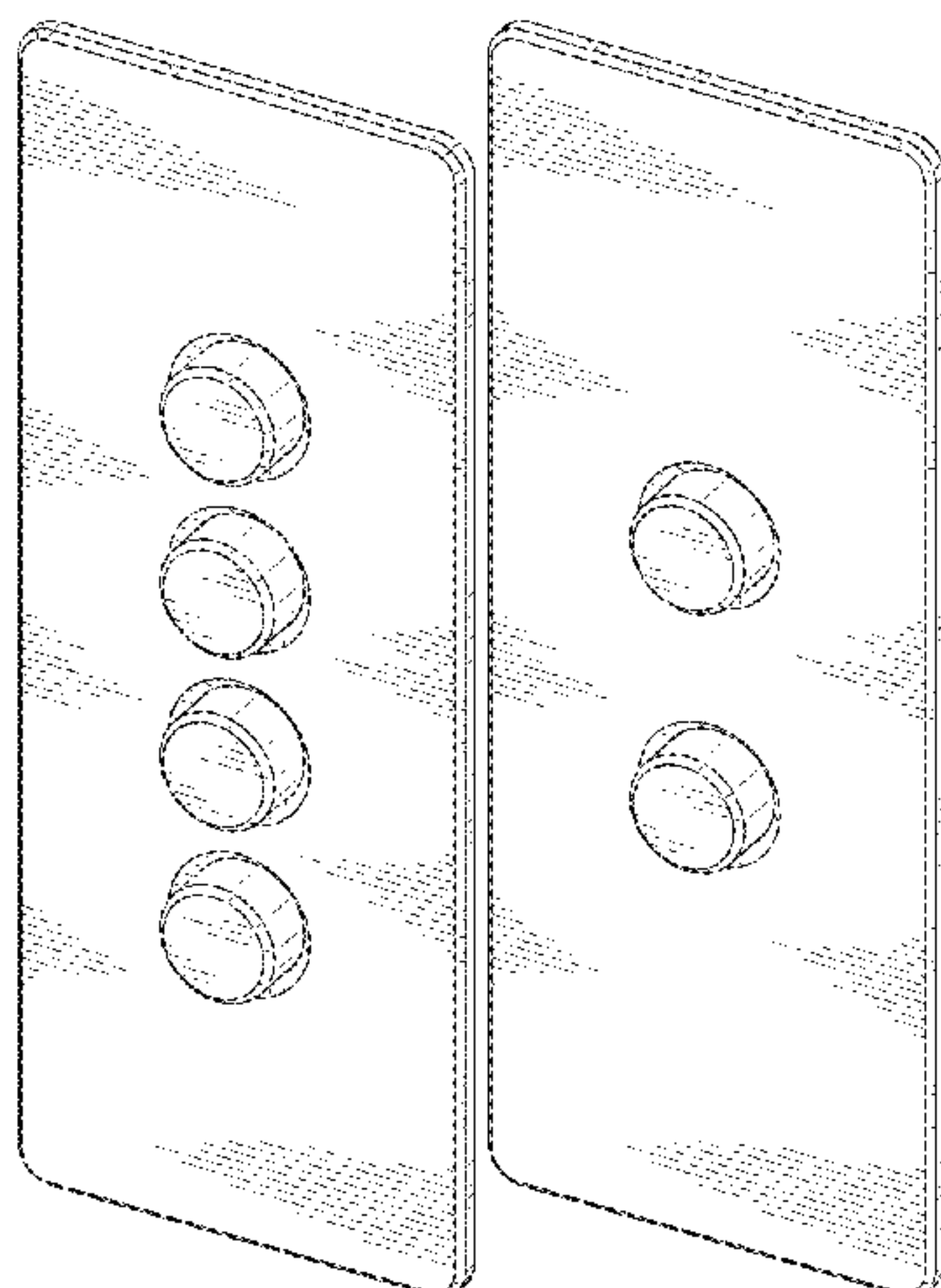

Forbes & Lomax, Catalogue, available at least as early as Sep. 9, 2017 (15 pages).

U.S. Appl. No. 29/616,874, filed Sep. 9, 2017 (unpublished).

U.S. Appl. No. 29/625,371, filed Nov. 9, 2017 (unpublished).

U.S. Appl. No. 29/634,277, filed Jan. 19, 2018 (unpublished).

U.S. Appl. No. 29/653,545, filed Jun. 15, 2018 (unpublished).

U.S. Appl. No. 29/723,770, filed Feb. 10, 2020 (unpublished).

U.S. Appl. No. 29/753,910, filed Oct. 4, 2020 (unpublished).

U.S. Appl. No. 29/753,911, filed Oct. 4, 2020 (unpublished).

U.S. Appl. No. 29/754,004, filed Oct. 5, 2020 (unpublished).

\* cited by examiner

*Primary Examiner* — Selina Sikder

(74) *Attorney, Agent, or Firm* — Saidman DesignLaw Group, LLC

(57) **CLAIM**

The ornamental design for a keypad, as shown and described.

**DESCRIPTION**

FIG. 1 is a front perspective view of a keypad showing our new design;

FIG. 2 is a front view thereof;

FIG. 3 is a left side view thereof;

FIG. 4 is a right side view thereof;

FIG. 5 is a top view thereof;

FIG. 6 is a bottom view thereof;

FIG. 7 is a front perspective view of a second embodiment thereof;

FIG. 8 is a front view thereof;

FIG. 9 is a left side view thereof;

FIG. 10 is a right side view thereof;

FIG. 11 is a top view thereof;

FIG. 12 is a bottom view thereof;

FIG. 13 is a front perspective view of a third embodiment thereof;

FIG. 14 is a front view thereof;

FIG. 15 is a left side view thereof;

FIG. 16 is a right side view thereof;

FIG. 17 is a top view thereof;

FIG. 18 is a bottom view thereof;

FIG. 19 is a front perspective view of a fourth embodiment thereof;

FIG. 20 is a front view thereof;

FIG. 21 is a left side view thereof;

FIG. 22 is a right side view thereof;

FIG. 23 is a top view thereof;

FIG. 24 is a bottom view thereof;

FIG. 25 is a front perspective view of a fifth embodiment thereof;

FIG. 26 is a front view thereof;

FIG. 27 is a left side view thereof;

FIG. 28 is a right side view thereof;

FIG. 29 is a top view thereof;

FIG. 30 is a bottom view thereof;

FIG. 31 is a front perspective view of a sixth embodiment thereof;

FIG. 32 is a front view thereof;

FIG. 33 is a left side view thereof;

FIG. 34 is a right side view thereof;

FIG. 35 is a top view thereof;

FIG. 36 is a bottom view thereof;

FIG. 37 is a front perspective view of a seventh embodiment thereof;

FIG. 38 is a front view thereof;

FIG. 39 is a left side view thereof;

FIG. 40 is a right side view thereof;

FIG. 41 is a top view thereof;

FIG. 42 is a bottom view thereof;

FIG. 43 is a front perspective view of a eighth embodiment thereof;

FIG. 44 is a front view thereof;

FIG. 45 is a left side view thereof;

FIG. 46 is a right side view thereof;

FIG. 47 is a top view thereof;

FIG. 48 is a bottom view thereof;

FIG. 49 is a front perspective view of a ninth embodiment thereof;

FIG. 50 is a front view thereof;

FIG. 51 is a left side view thereof;

FIG. 52 is a right side view thereof;

FIG. 53 is a top view thereof;

FIG. 54 is a bottom view thereof;

FIG. 55 is a front perspective view of a tenth embodiment thereof;

FIG. 56 is a front view thereof;

FIG. 57 is a left side view thereof;

FIG. 58 is a right side view thereof;

FIG. 59 is a top view thereof;

FIG. 60 is a bottom view thereof;

FIG. 61 is a front perspective view of an eleventh embodiment thereof;

FIG. 62 is a front view thereof;

FIG. 63 is a left side view thereof;

FIG. 64 is a right side view thereof;

FIG. 65 is a top view thereof;

FIG. 66 is a bottom view thereof;

FIG. 67 is a front perspective view of a twelfth embodiment thereof;

FIG. 68 is a front view thereof;

FIG. 69 is a left side view thereof;

FIG. 70 is a right side view thereof;

FIG. 71 is a top view thereof; and,

FIG. 72 is a bottom view thereof.

The contour of the buttons in FIGS. 7-18 is the same as the contour of the buttons in FIGS. 1-6.

The contour of the buttons in FIGS. 25-36 is the same as the contour of the buttons in FIGS. 19-24.

The contour of the buttons in FIGS. 43-54 is the same as the contour of the buttons in FIGS. 37-42.

The contour of the buttons in FIGS. 61-72 is same as the contour of the buttons in FIGS. 55-60.

The uniform dashed broken lines illustrate structure or features which form no part of the claimed design.

The dark gray shading represents a matte surface, not surface ornamentation or any particular color.

The light gray shading represents a reflective/shiny surface, not surface ornamentation or any particular color.



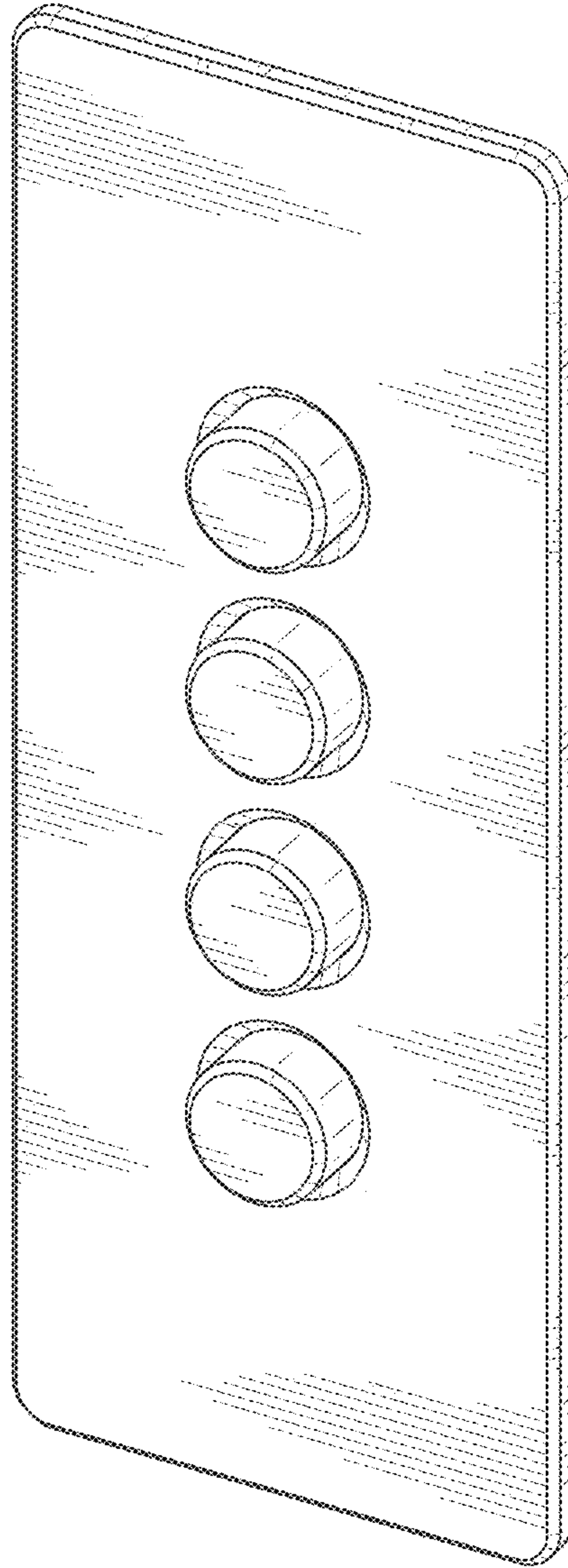

FIG. 1

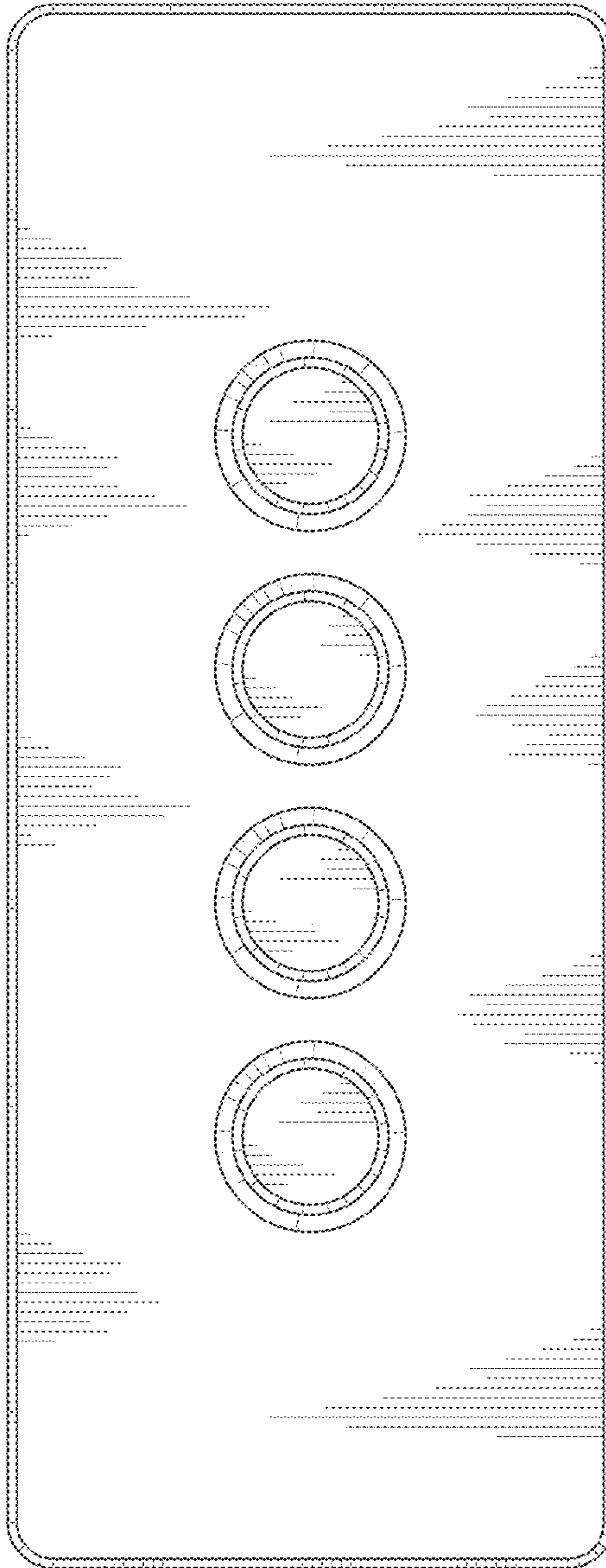

FIG. 2

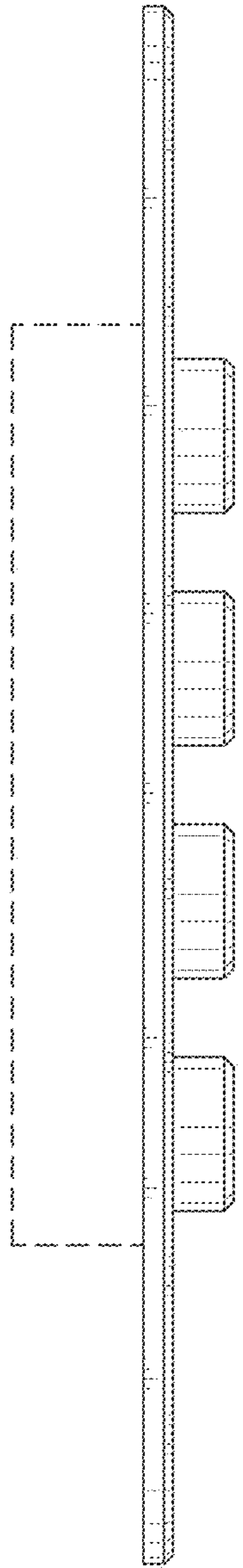

FIG. 3

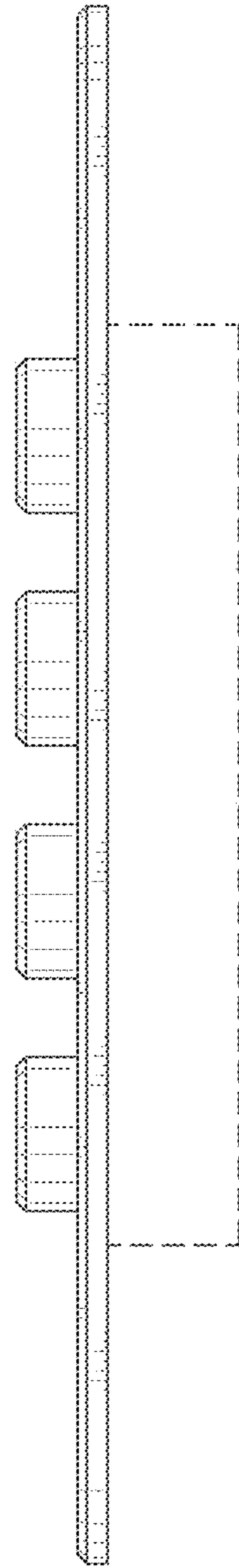

FIG. 4

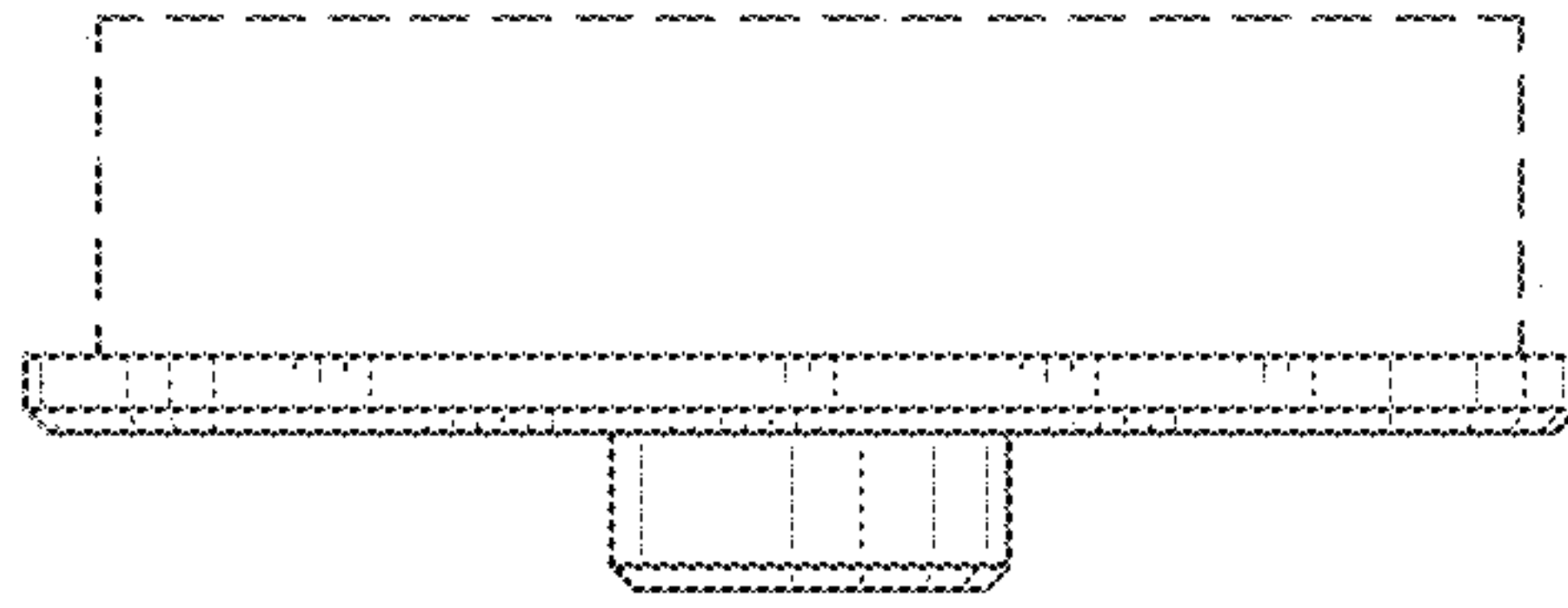

FIG. 5

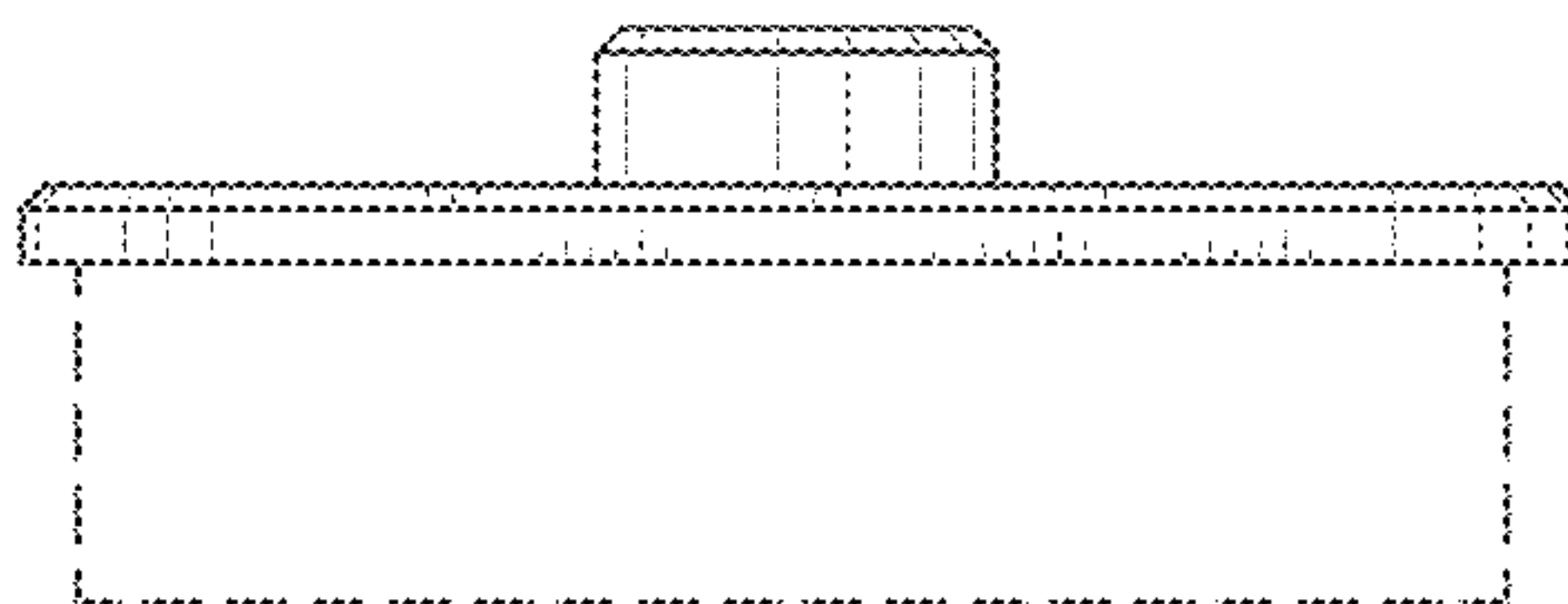

FIG. 6

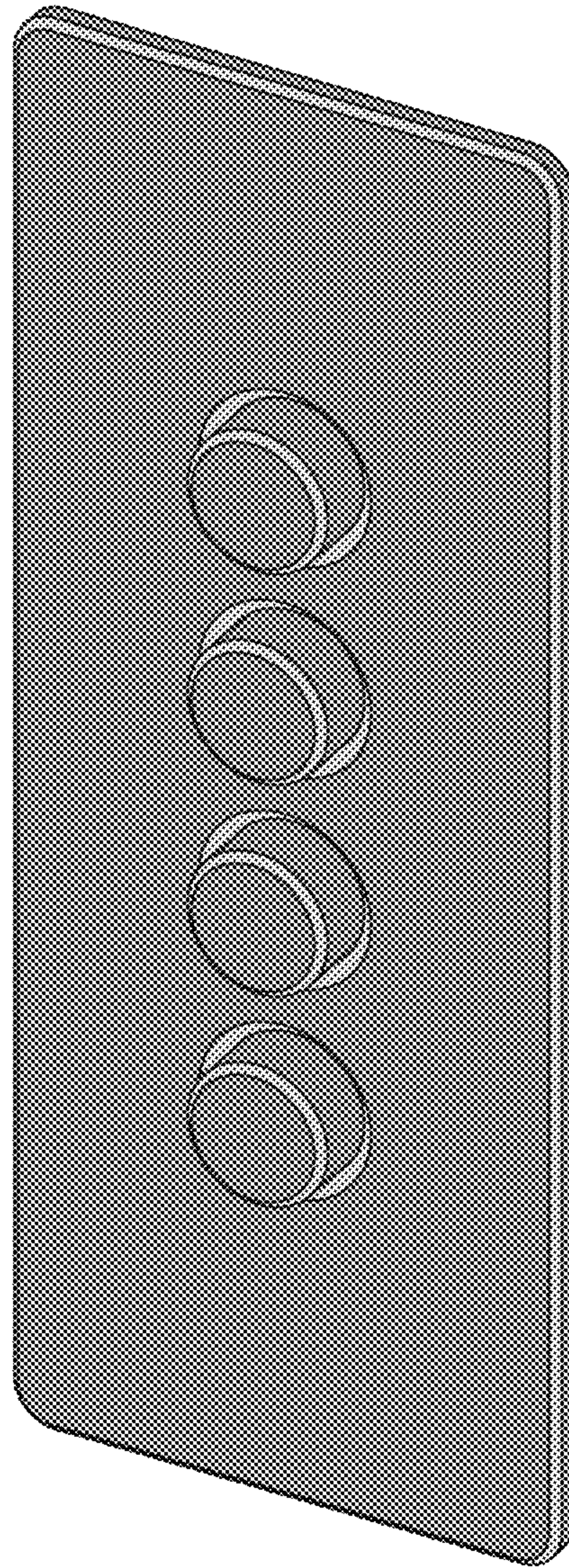

FIG. 7



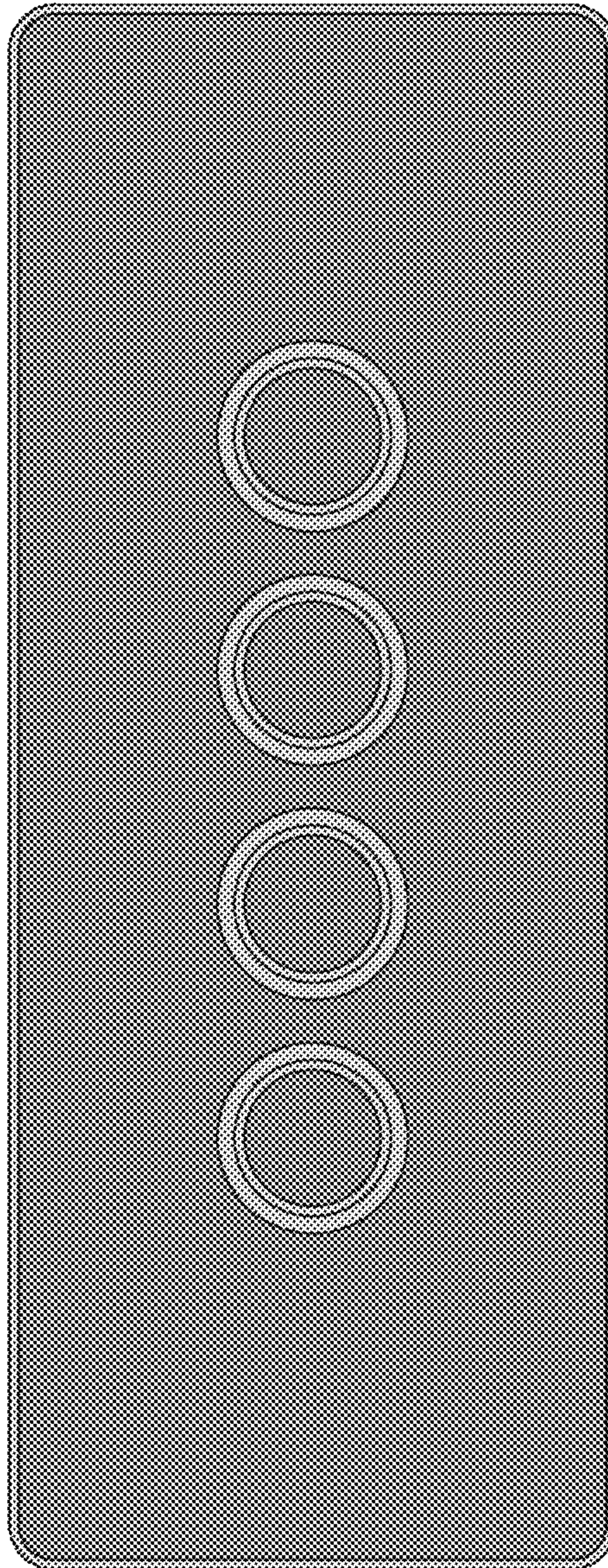

FIG. 8



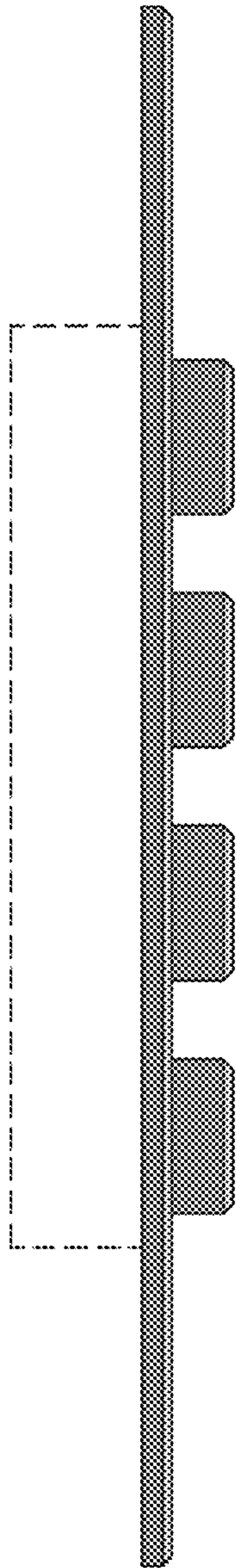

FIG. 9

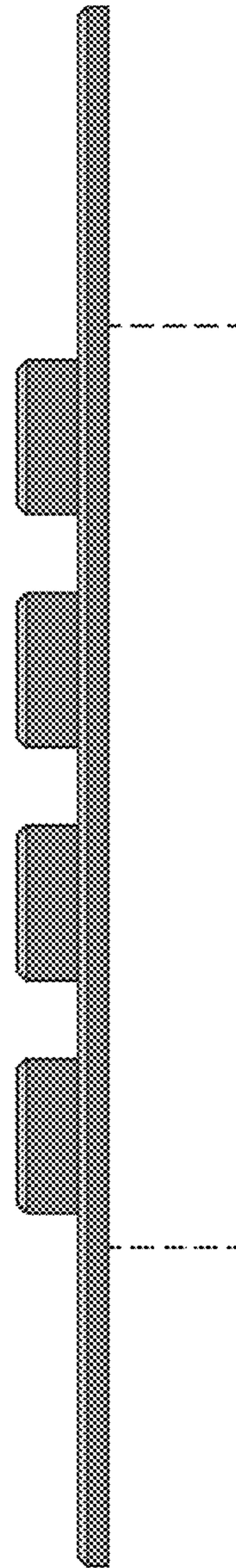

FIG. 10

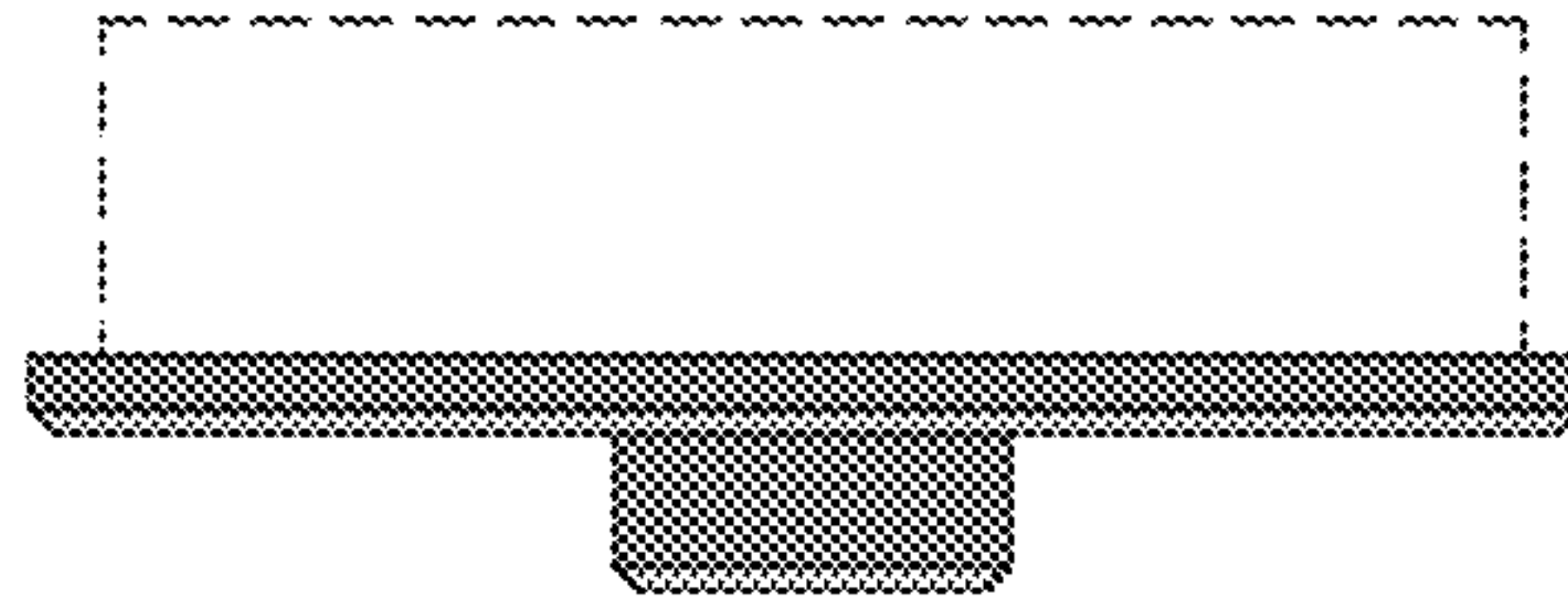

FIG. 11

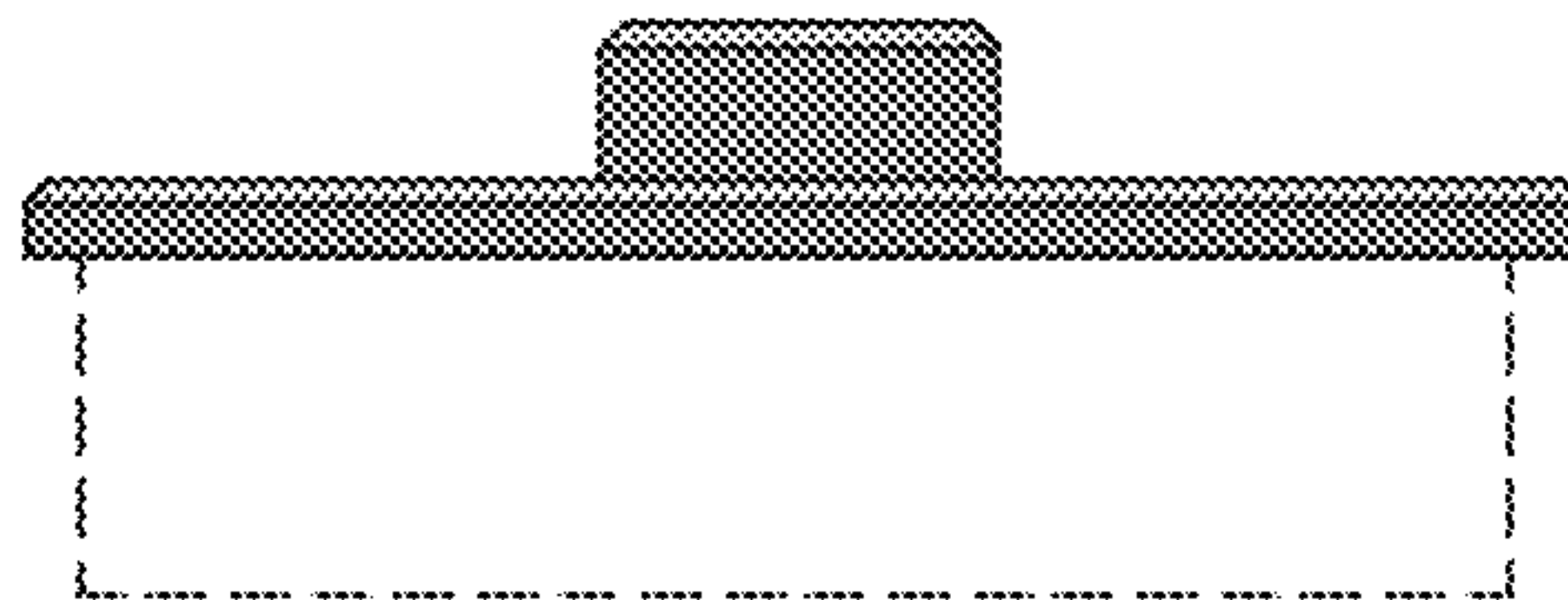

FIG. 12

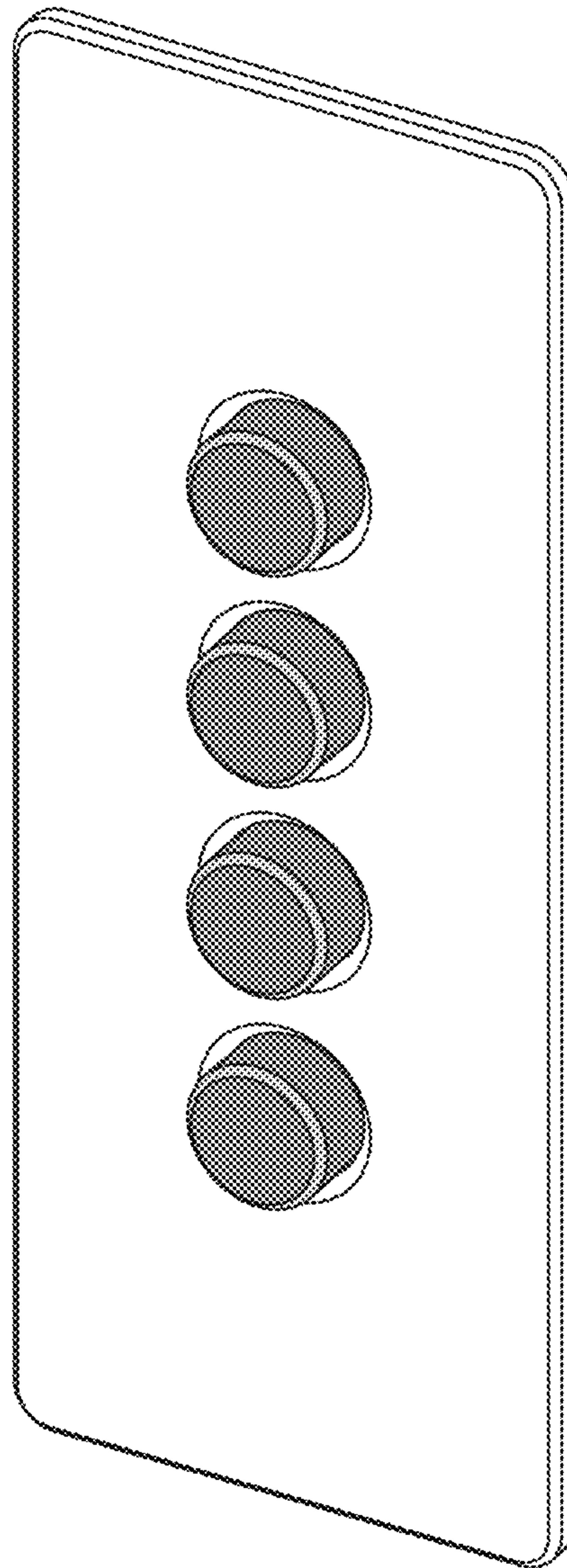

FIG. 13



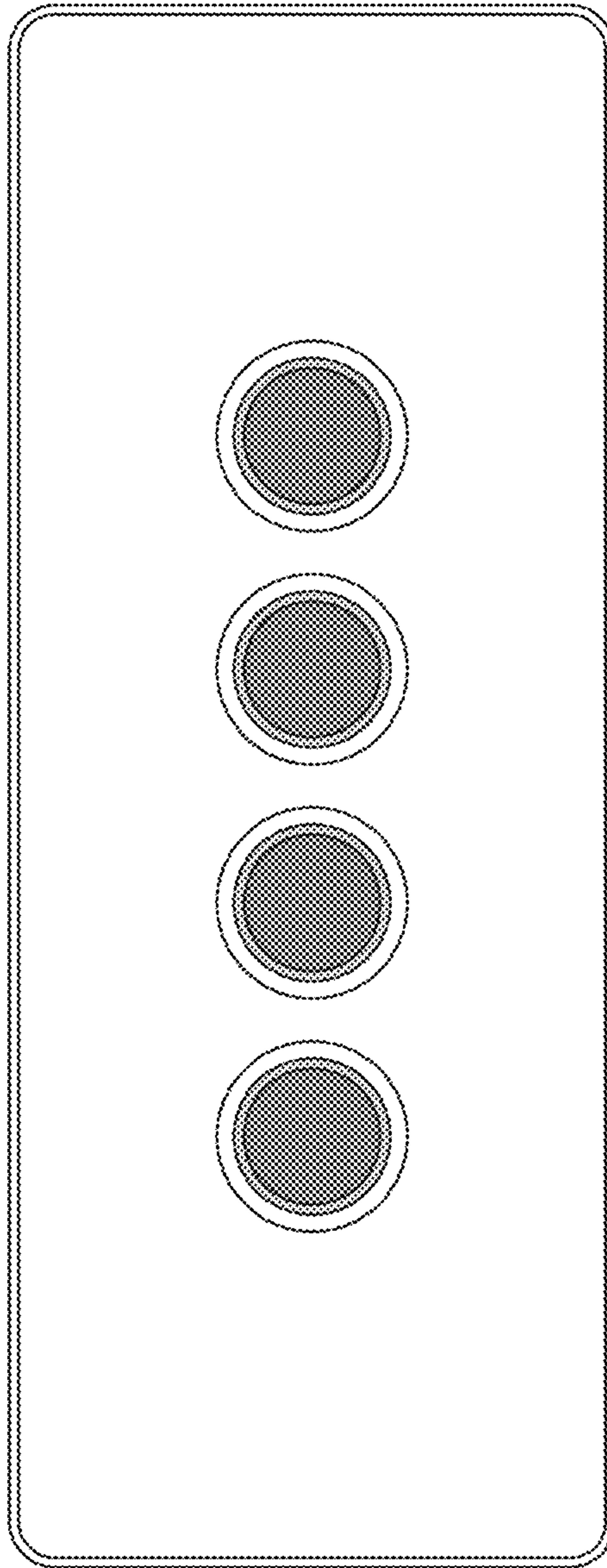

FIG. 14

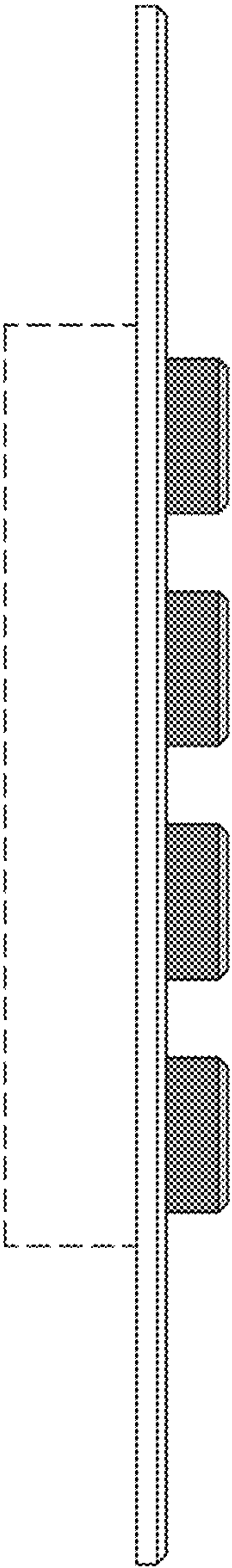

FIG. 15

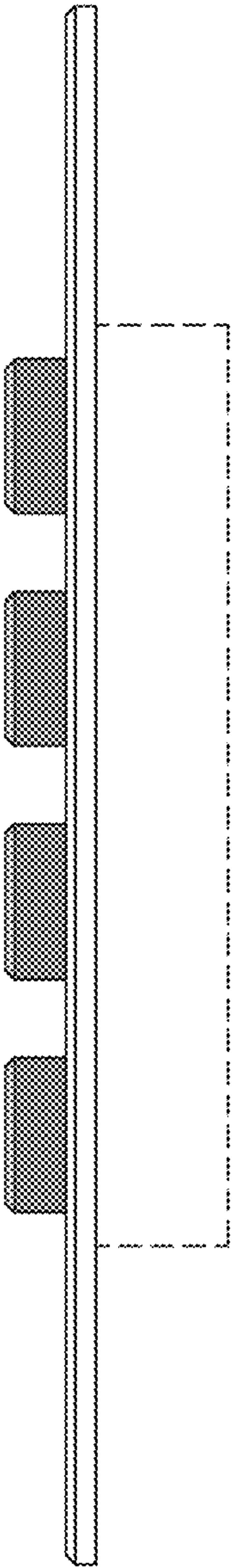

FIG. 16

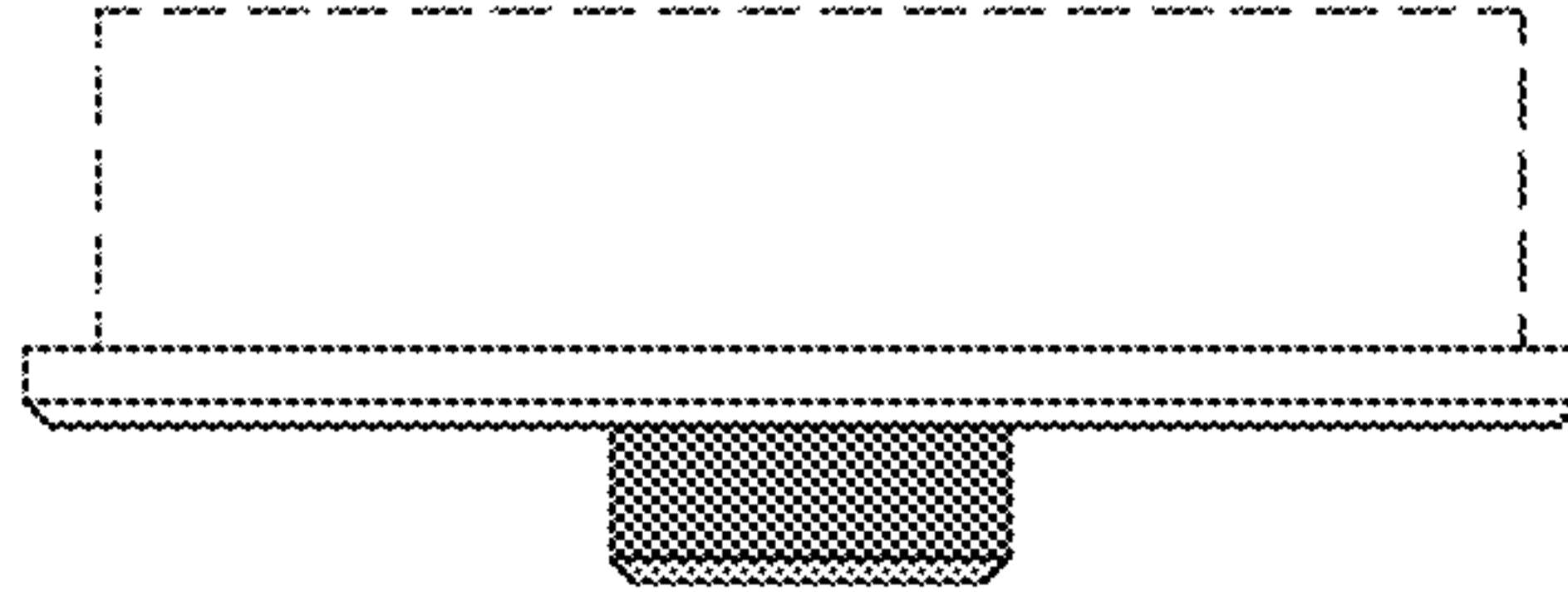

FIG. 17

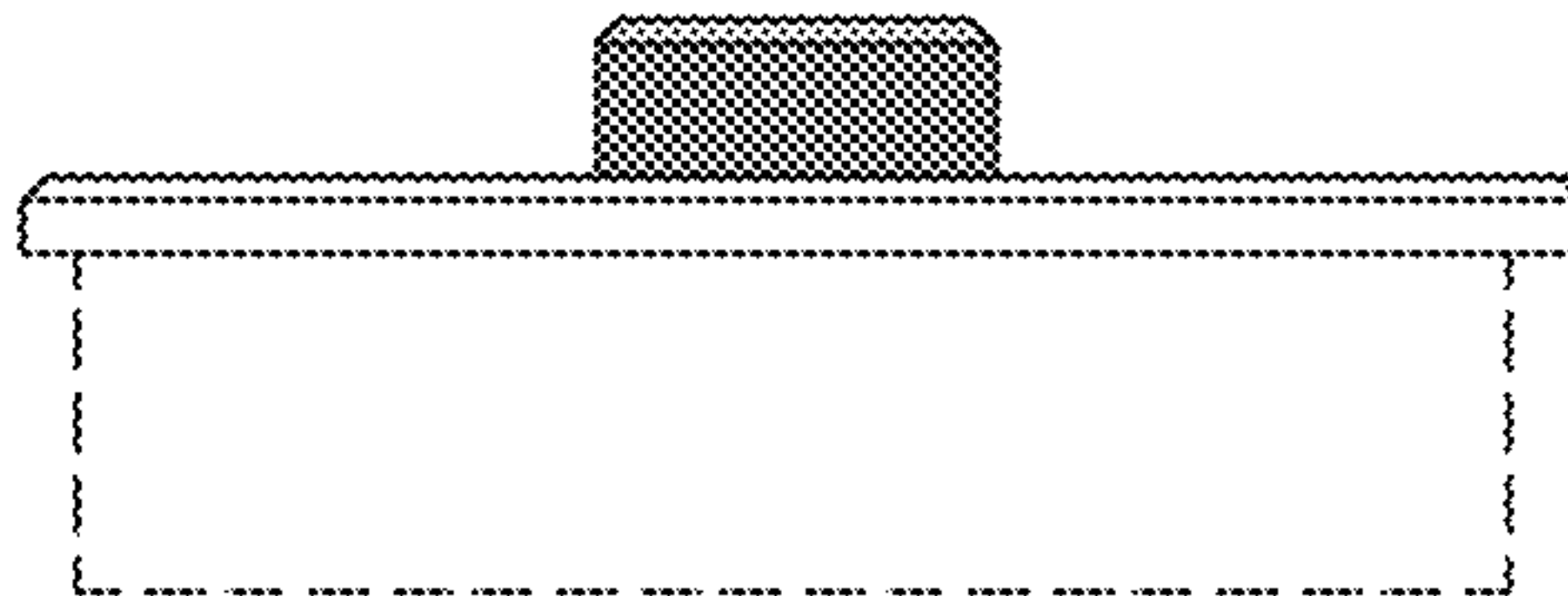

FIG. 18



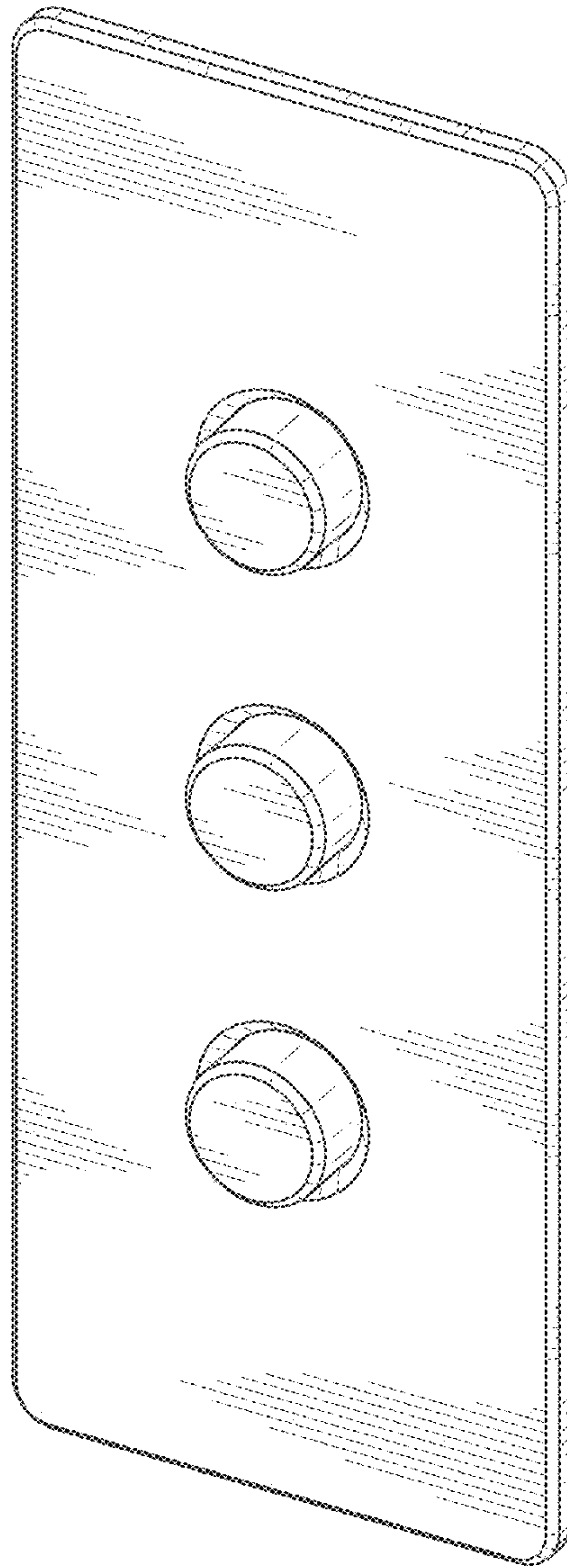

FIG. 19

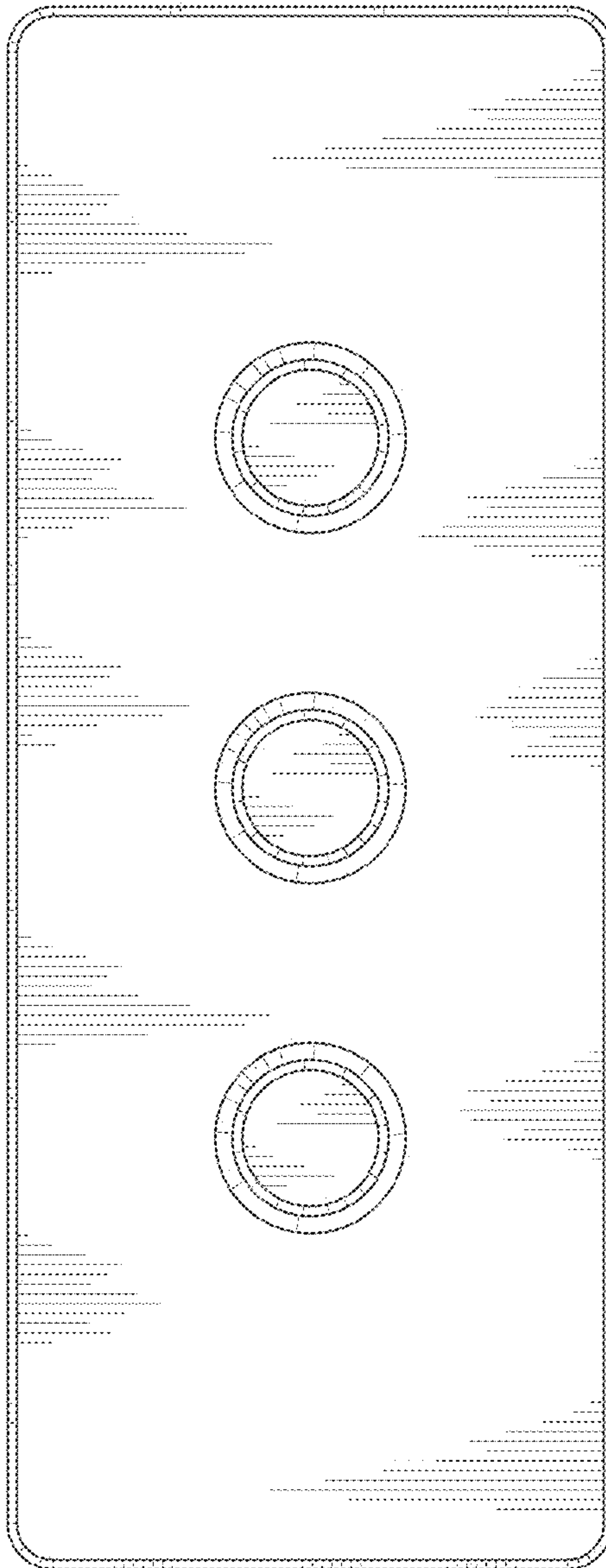

FIG. 20

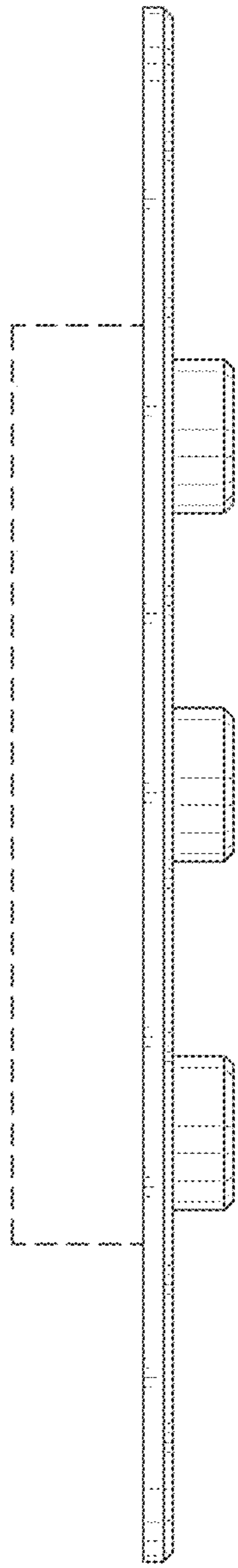

FIG. 21

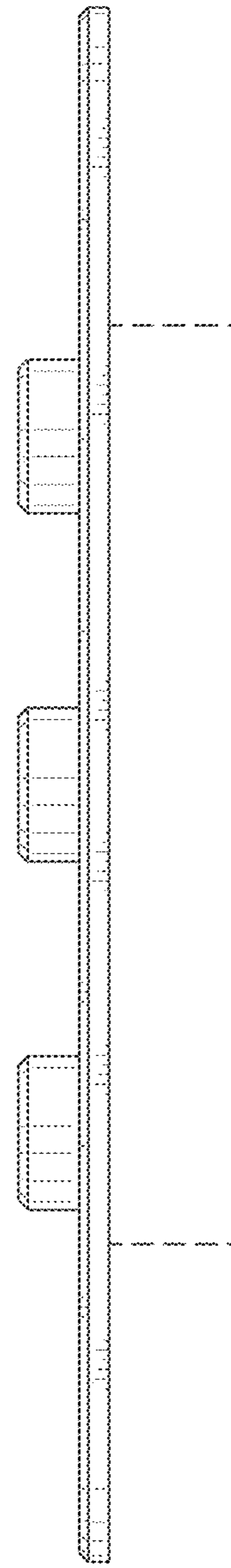

FIG. 22



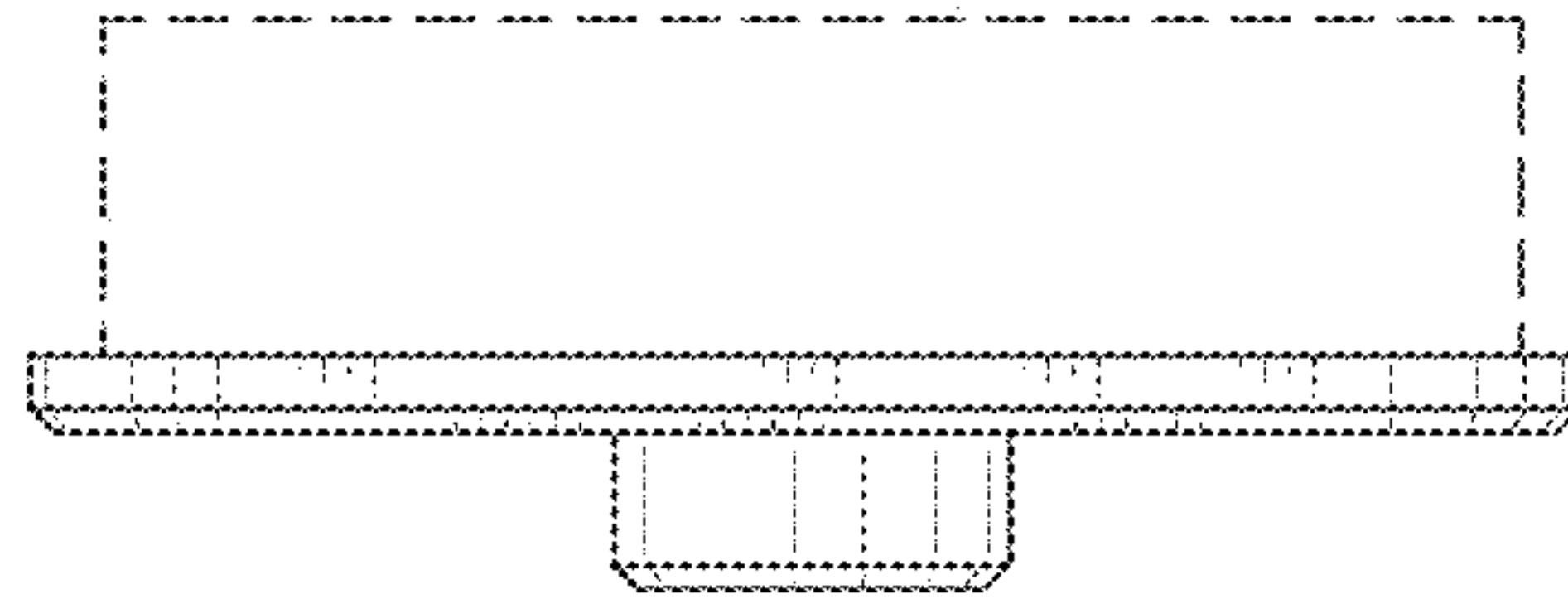

FIG. 23

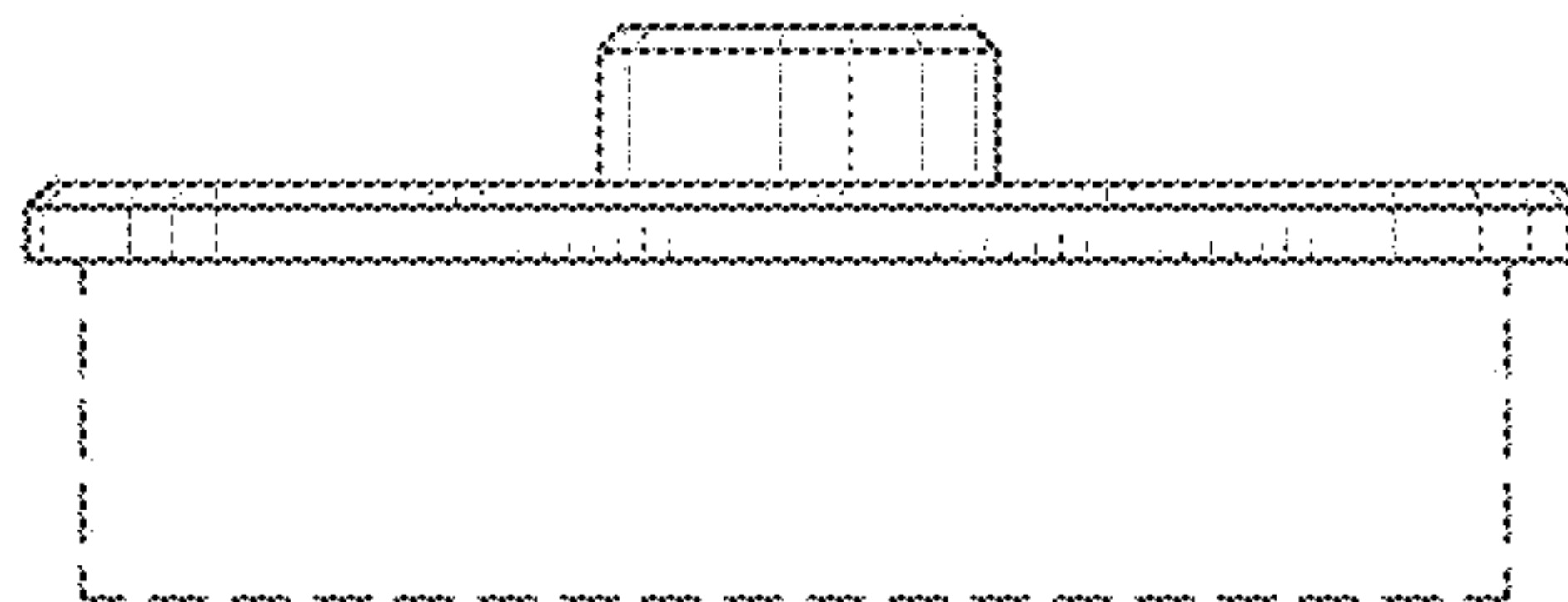

FIG. 24

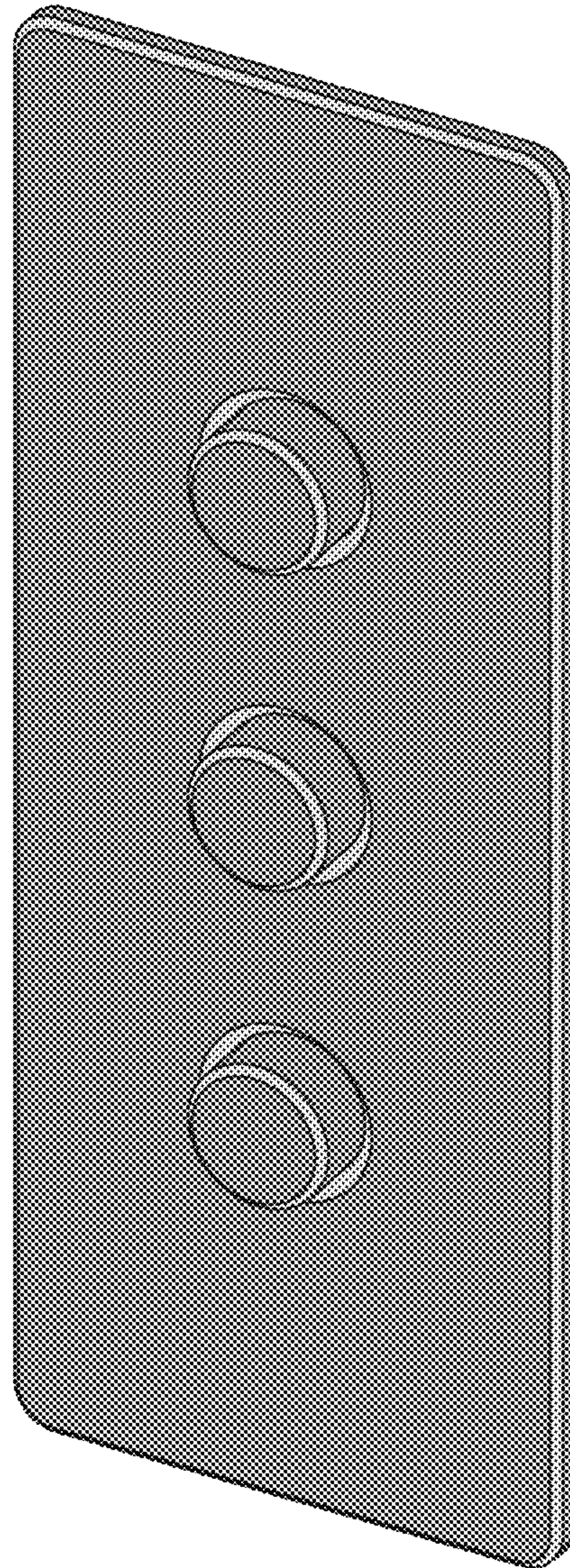

FIG. 25

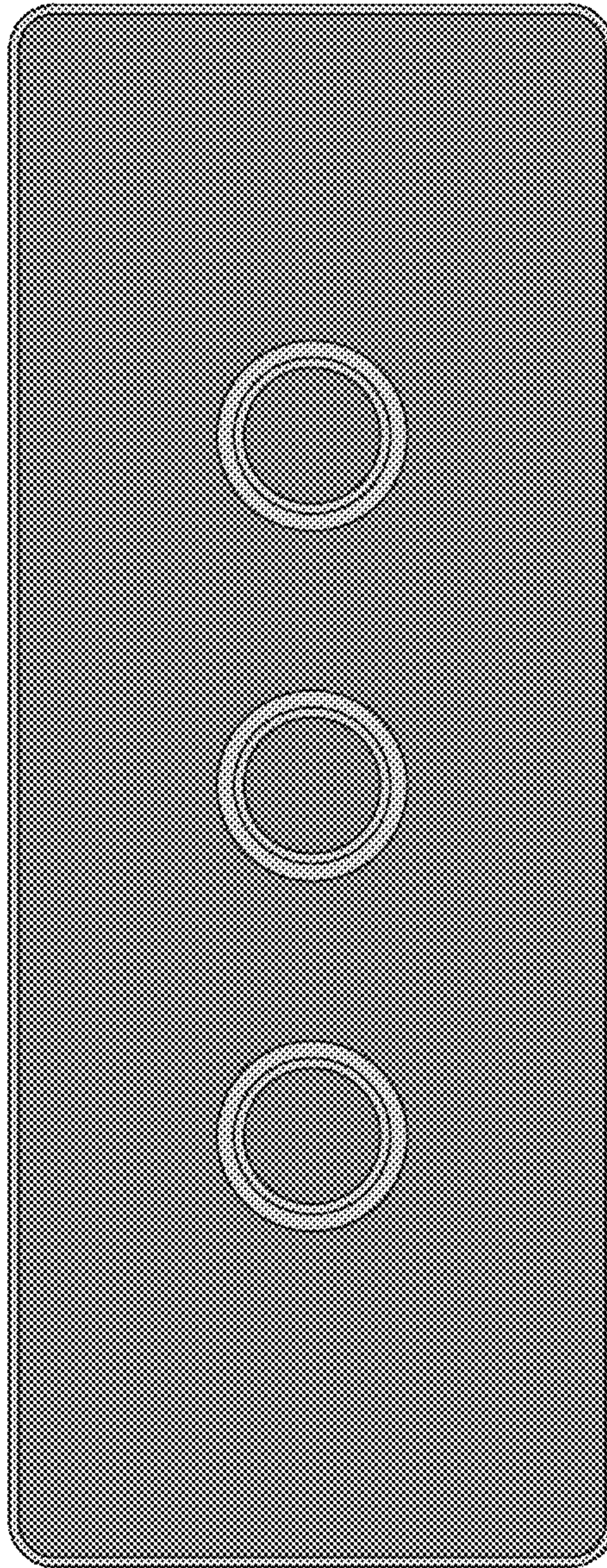

FIG. 26



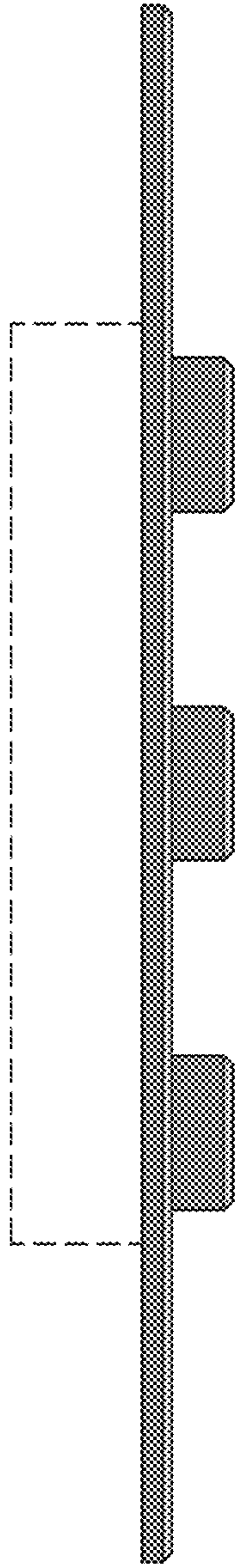

FIG. 27

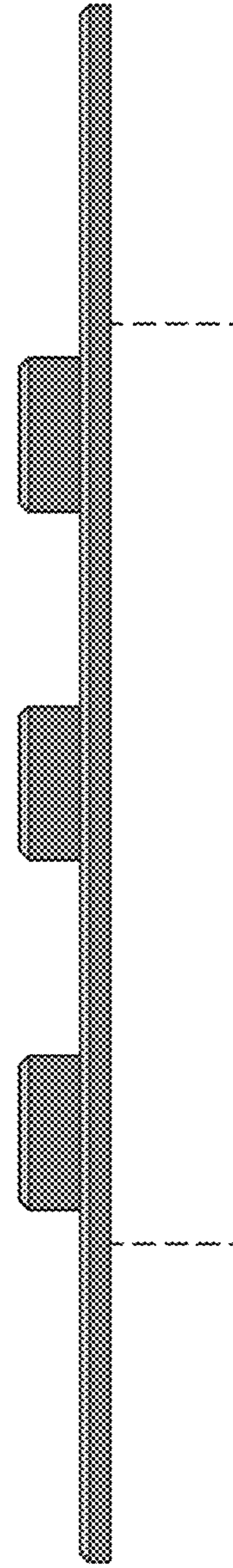

FIG. 28

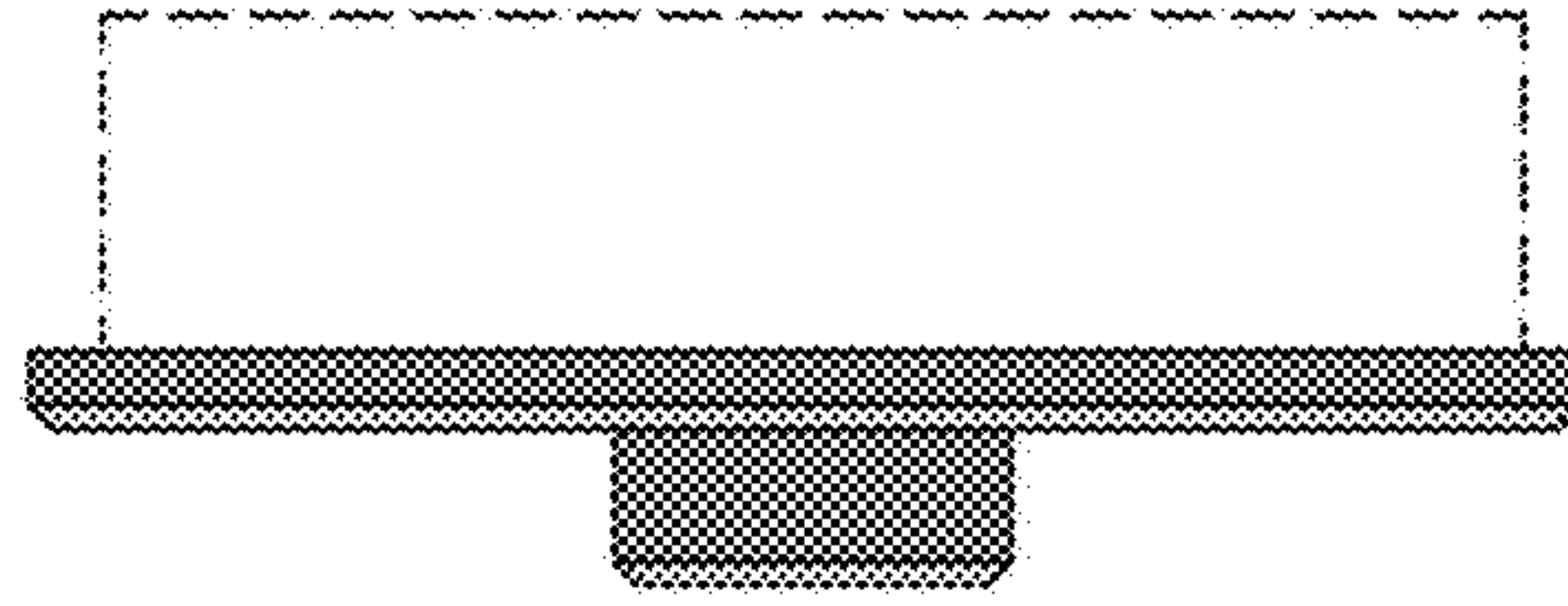

FIG. 29

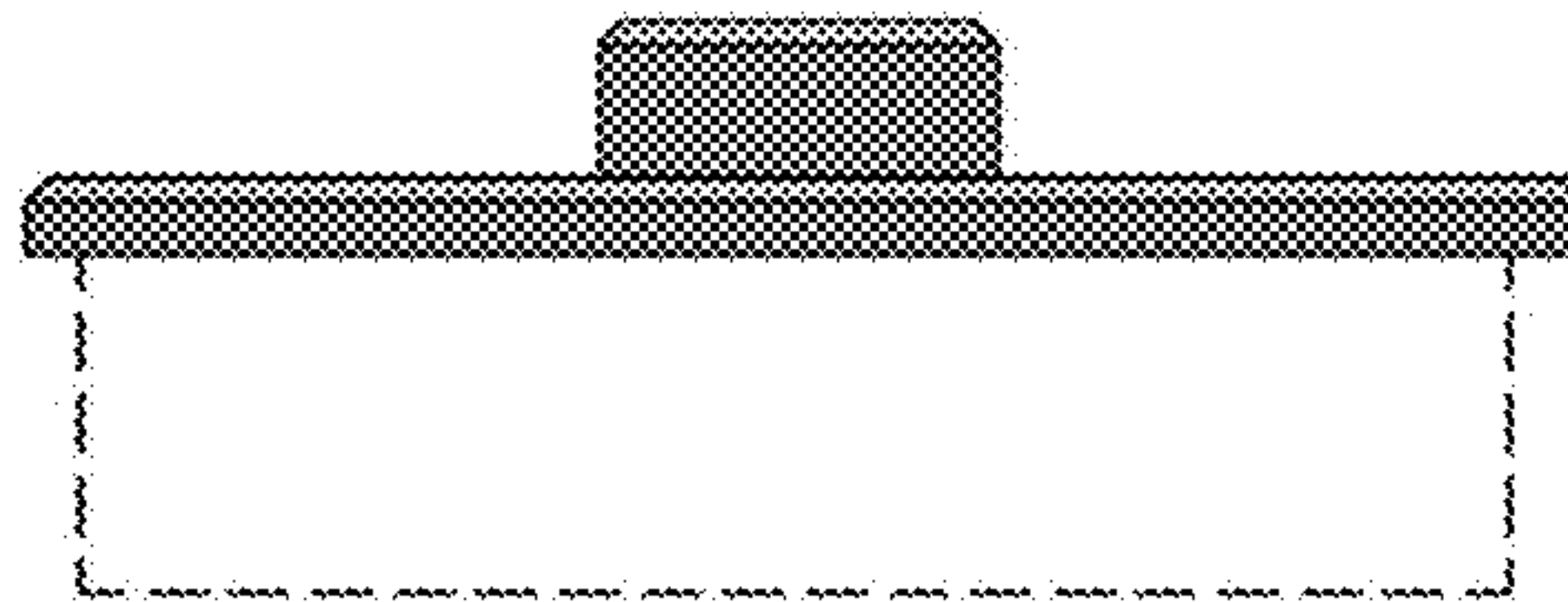

FIG. 30

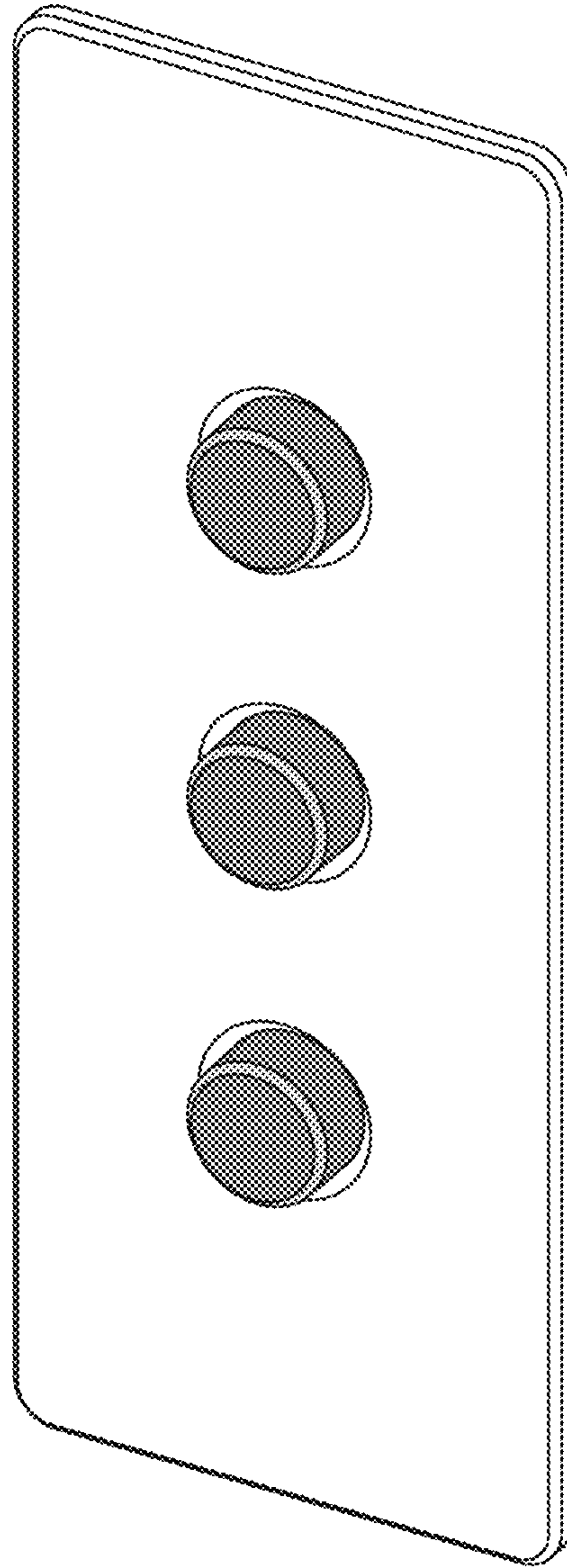

FIG. 31

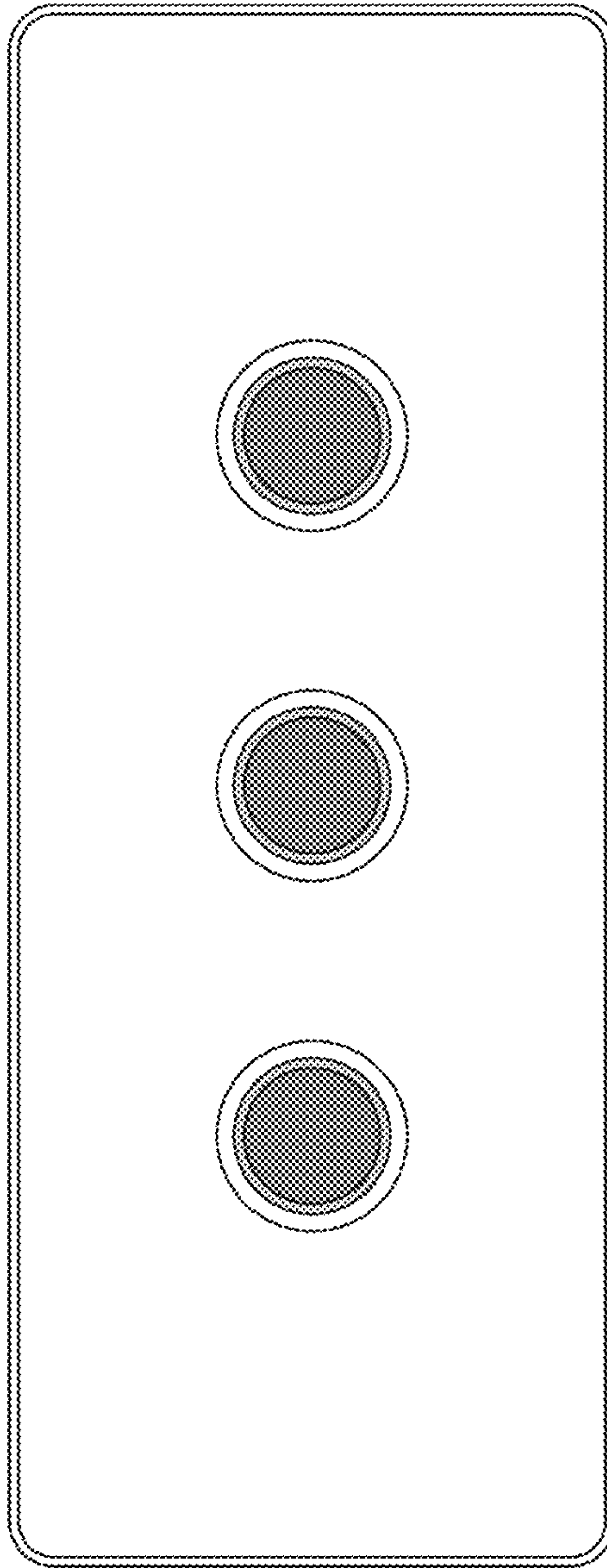

FIG. 32



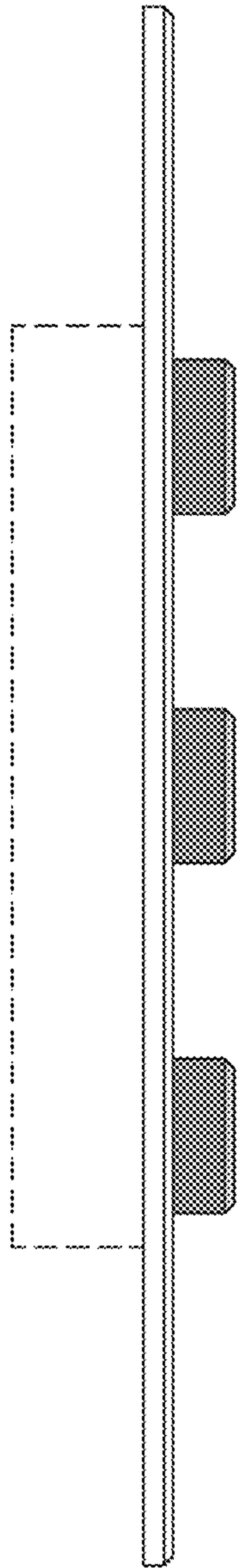

FIG. 33

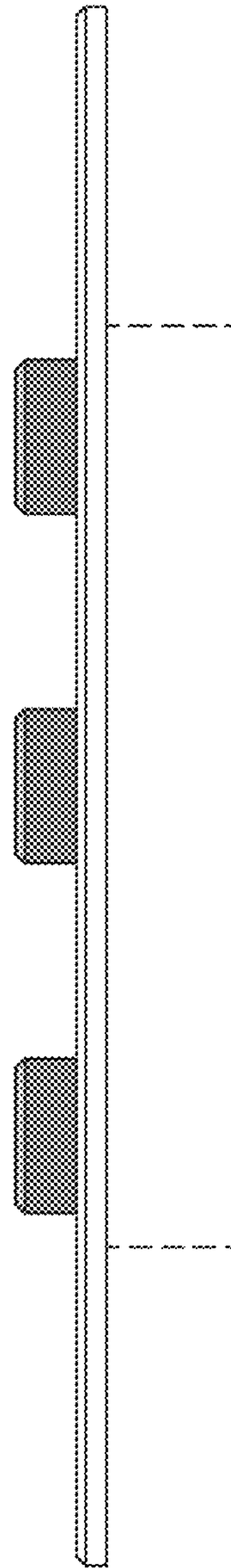

FIG. 34

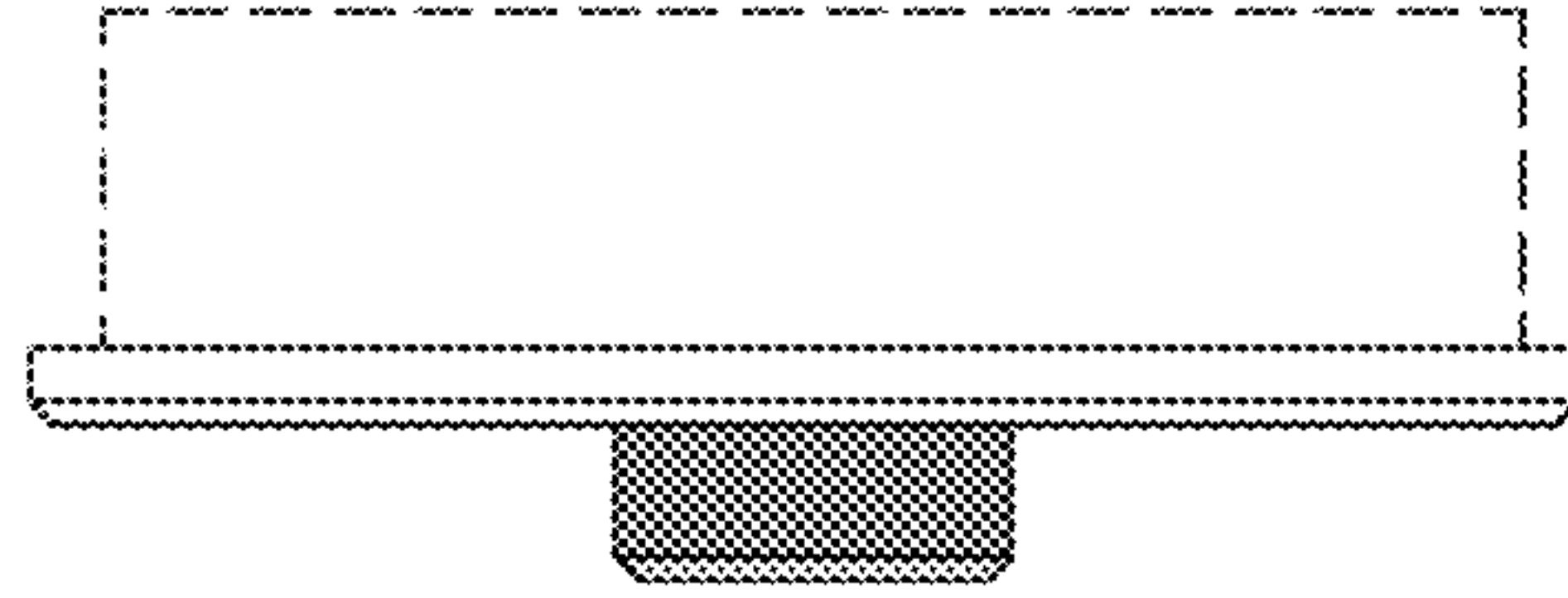

FIG. 35

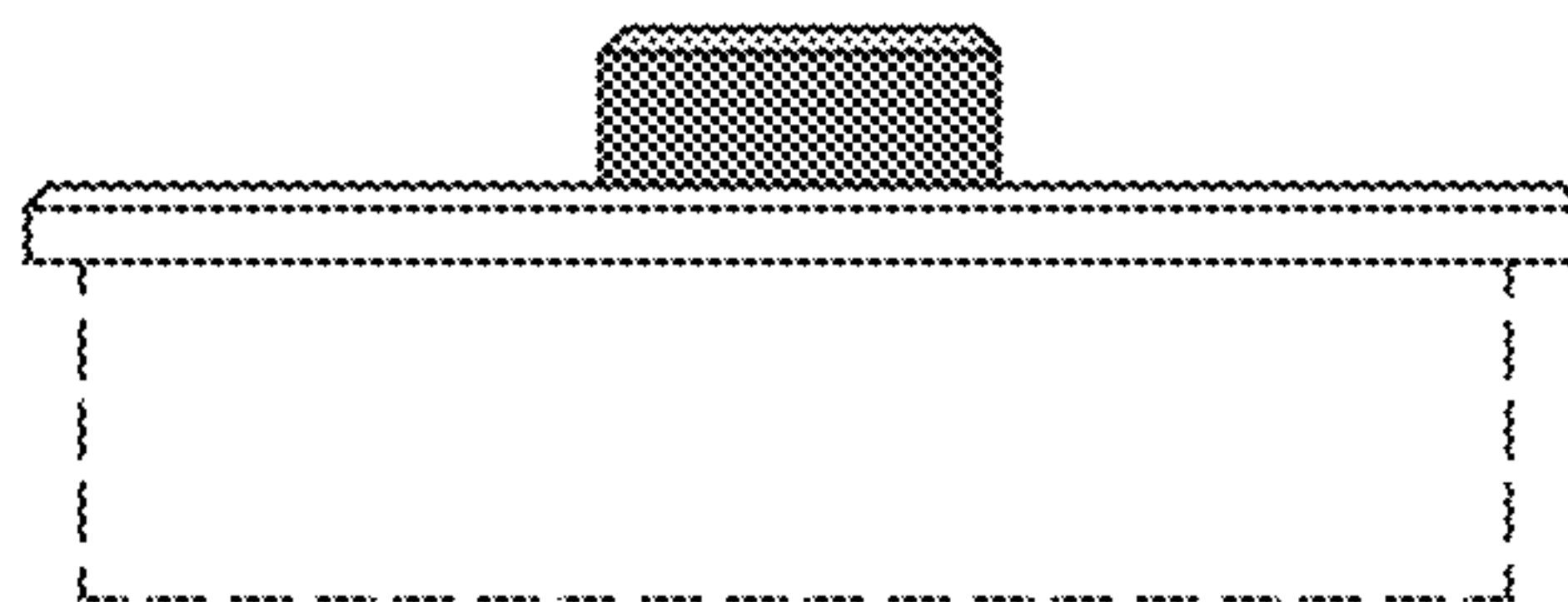

FIG. 36

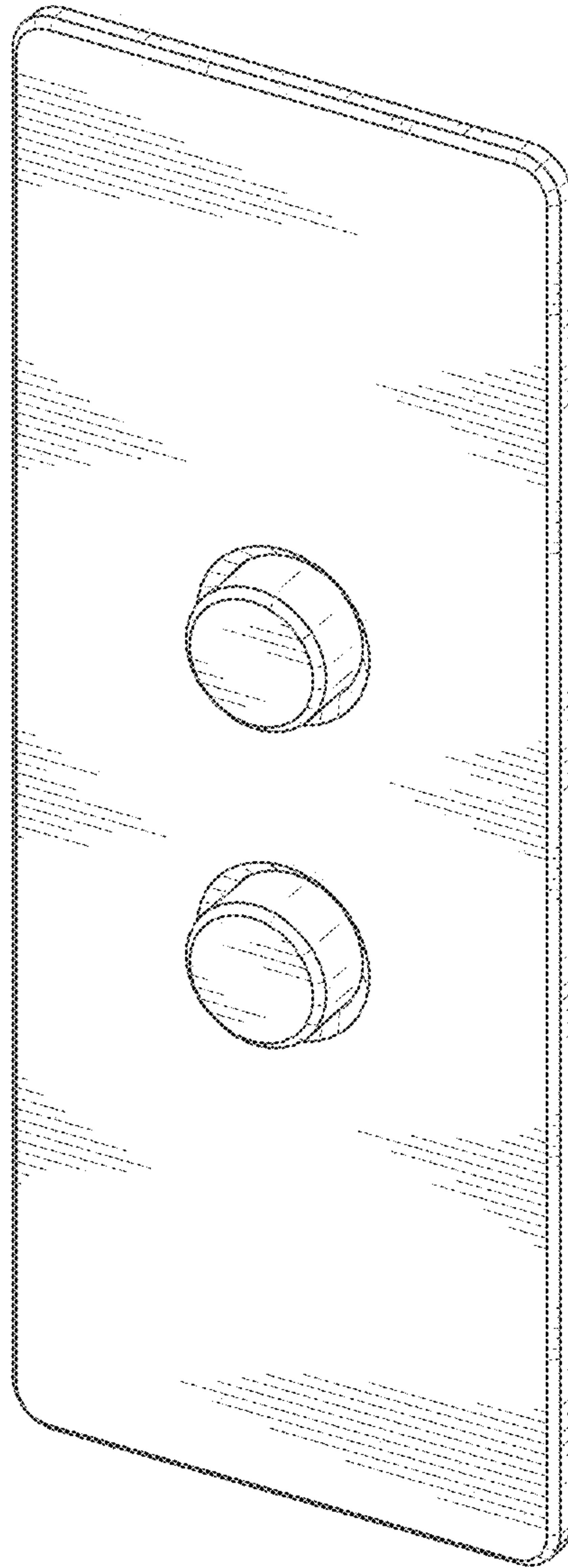

FIG. 37

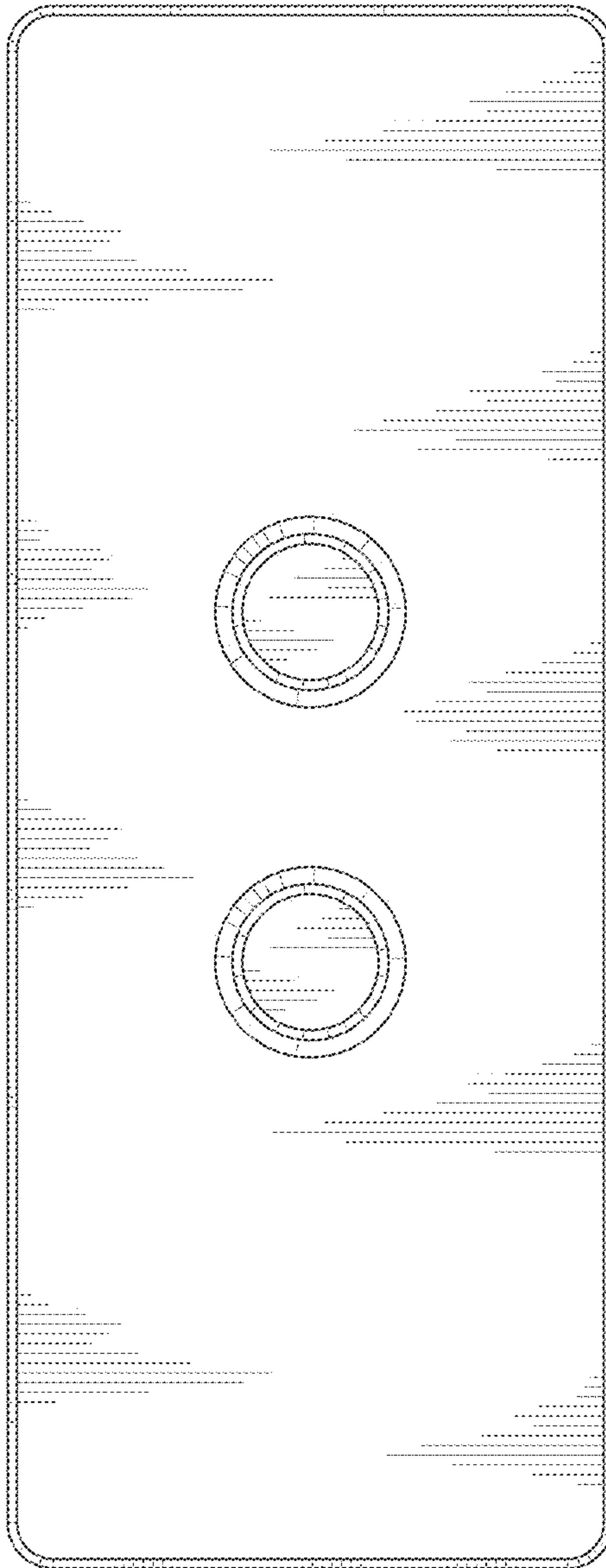

FIG. 38

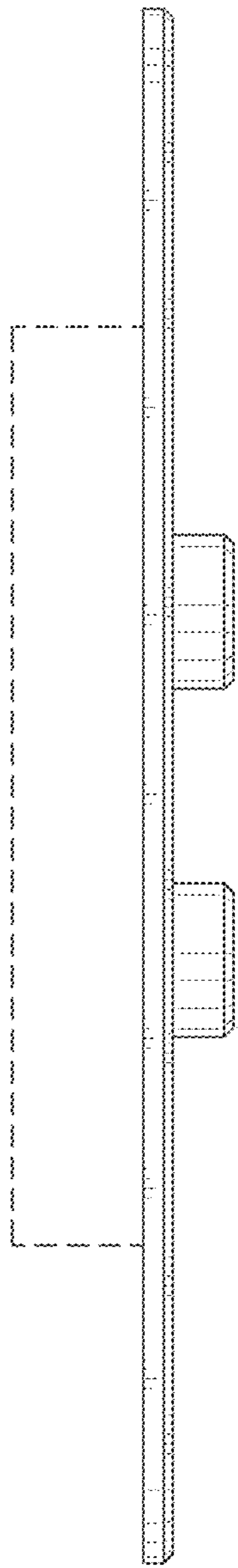

FIG. 39

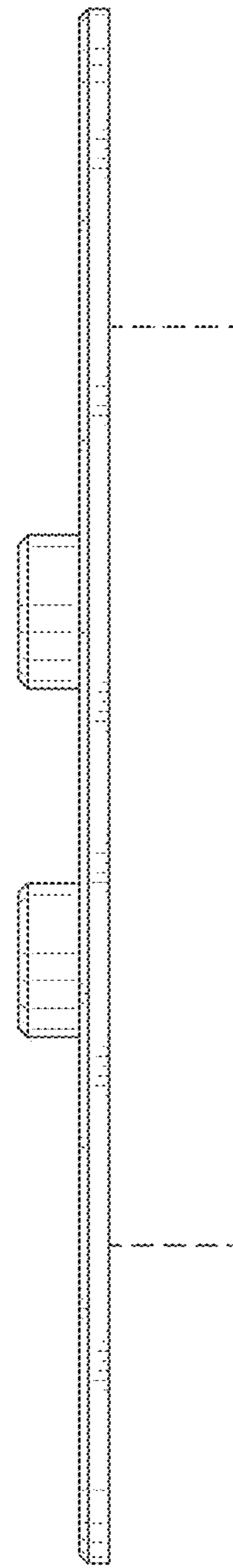

FIG. 40



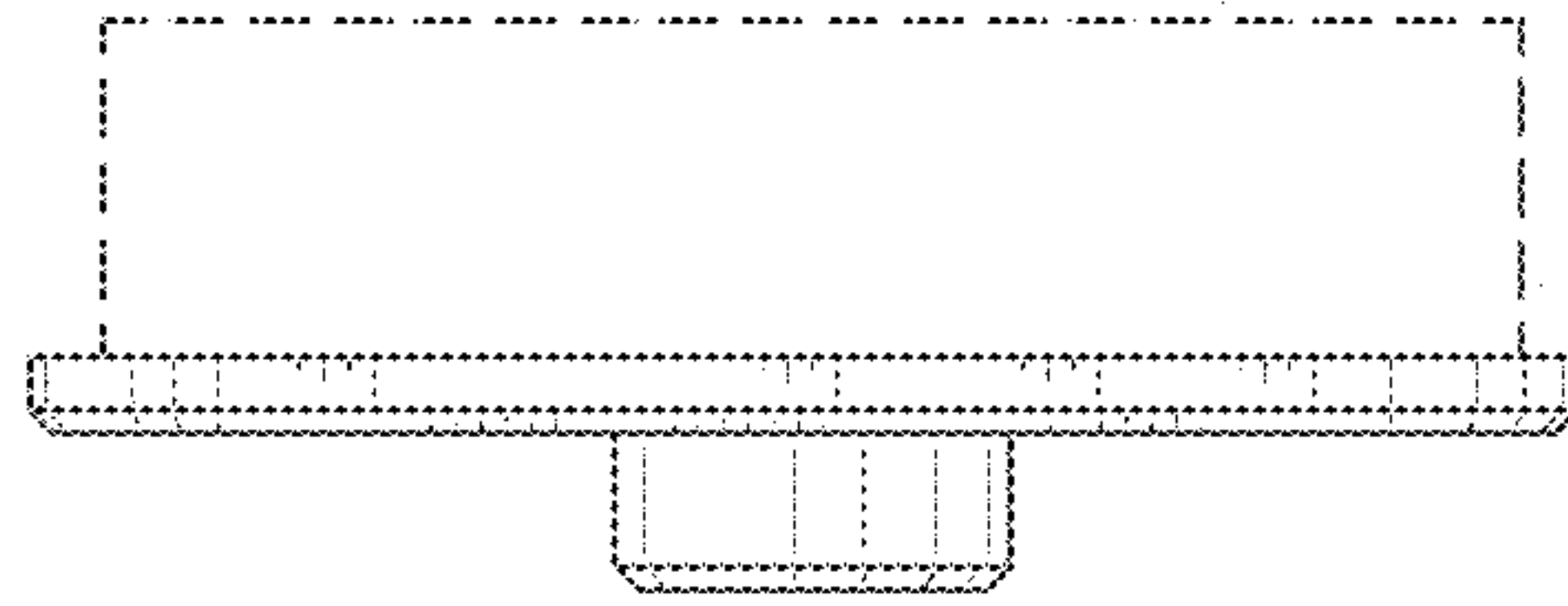

FIG. 41

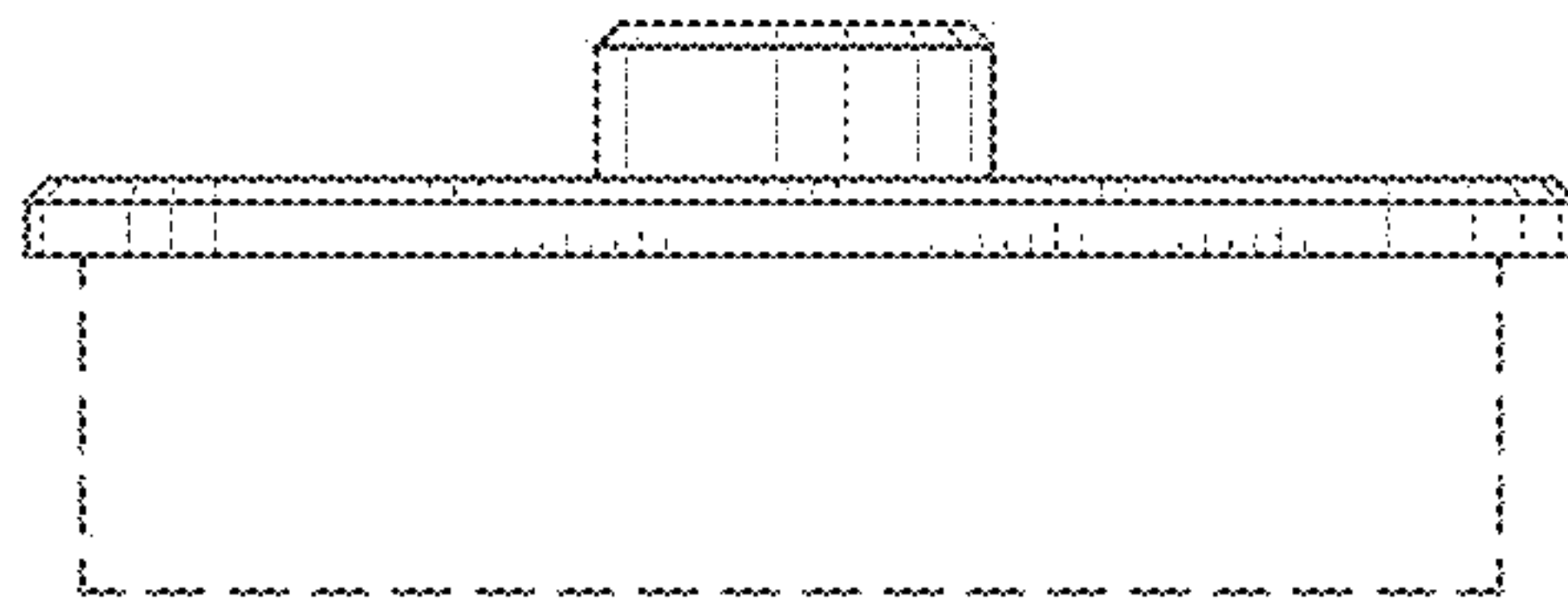

FIG. 42

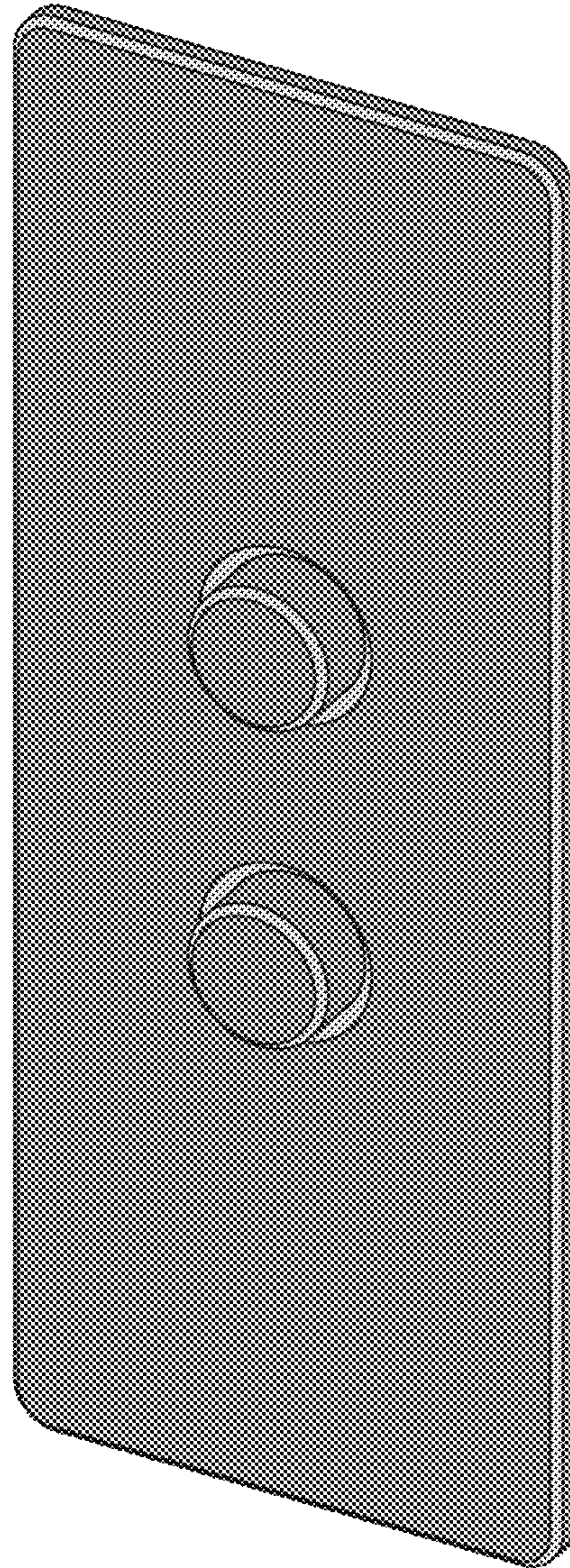

FIG. 43

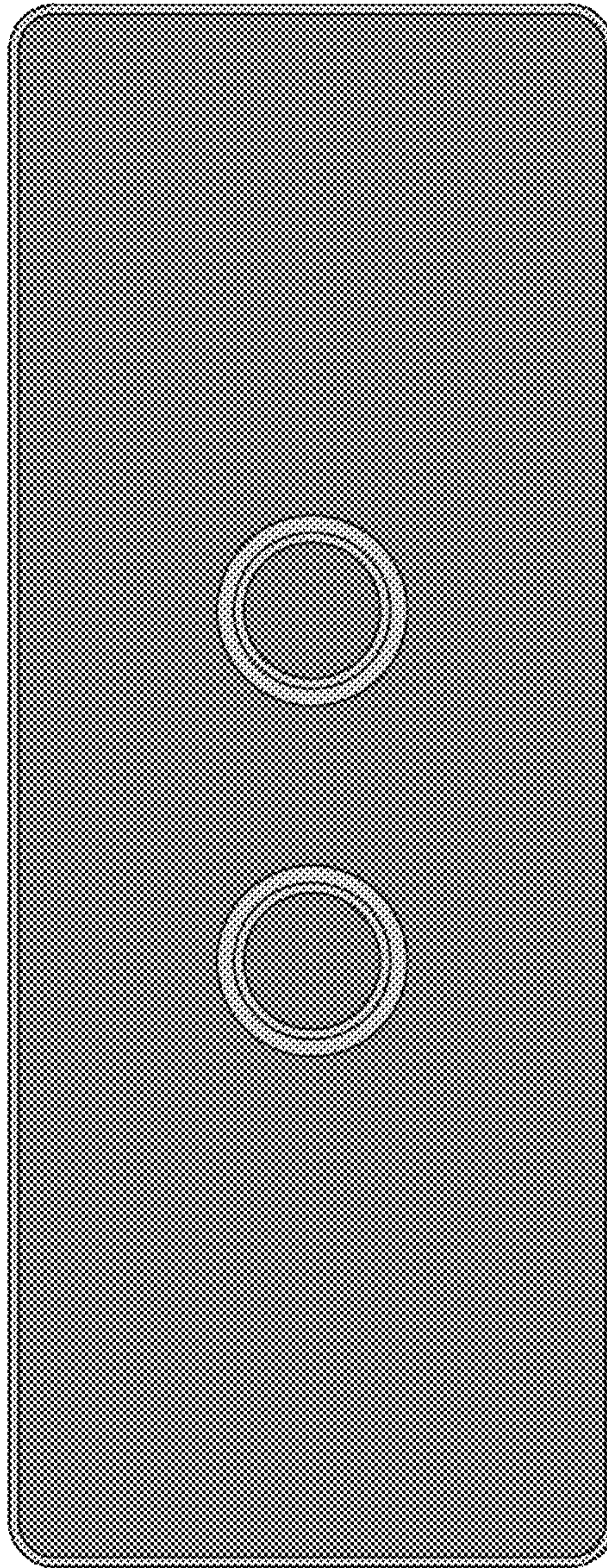

FIG. 44

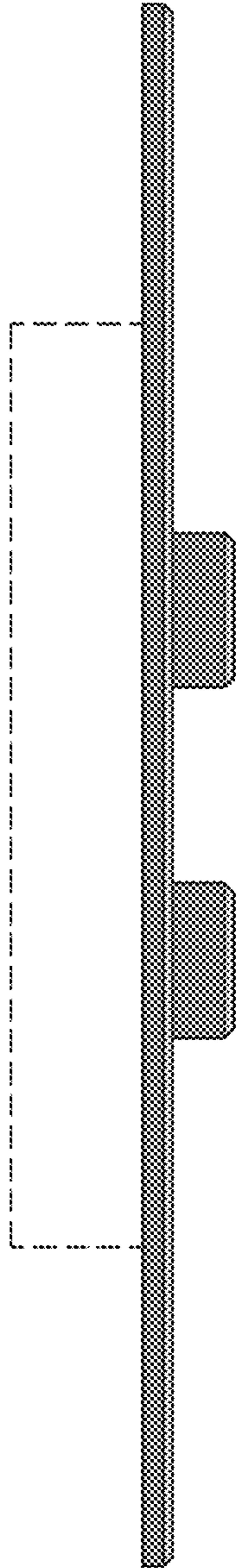

FIG. 45

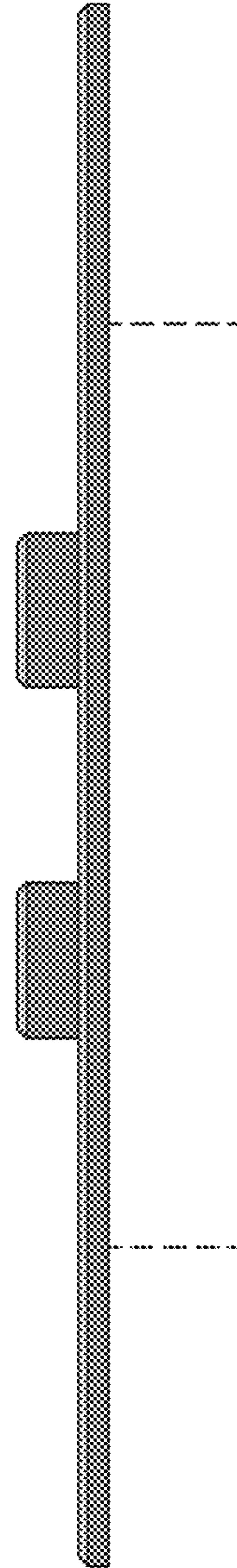

FIG. 46



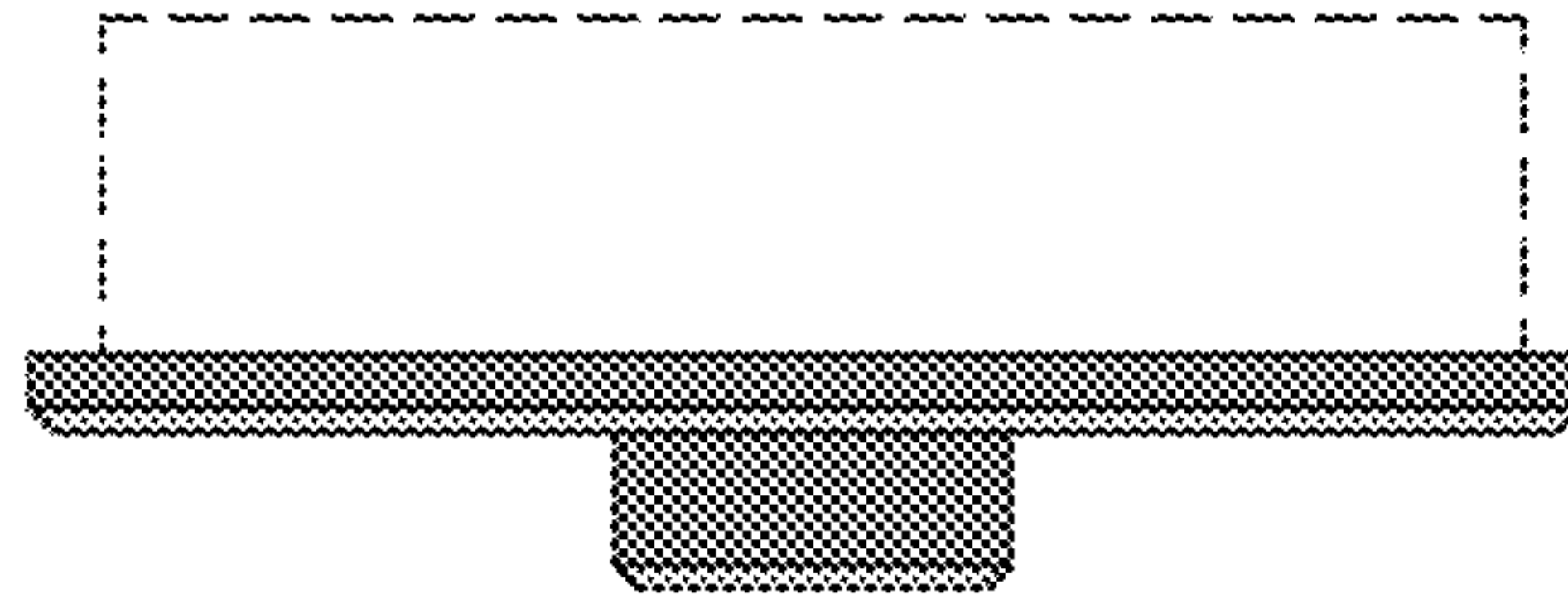

FIG. 47

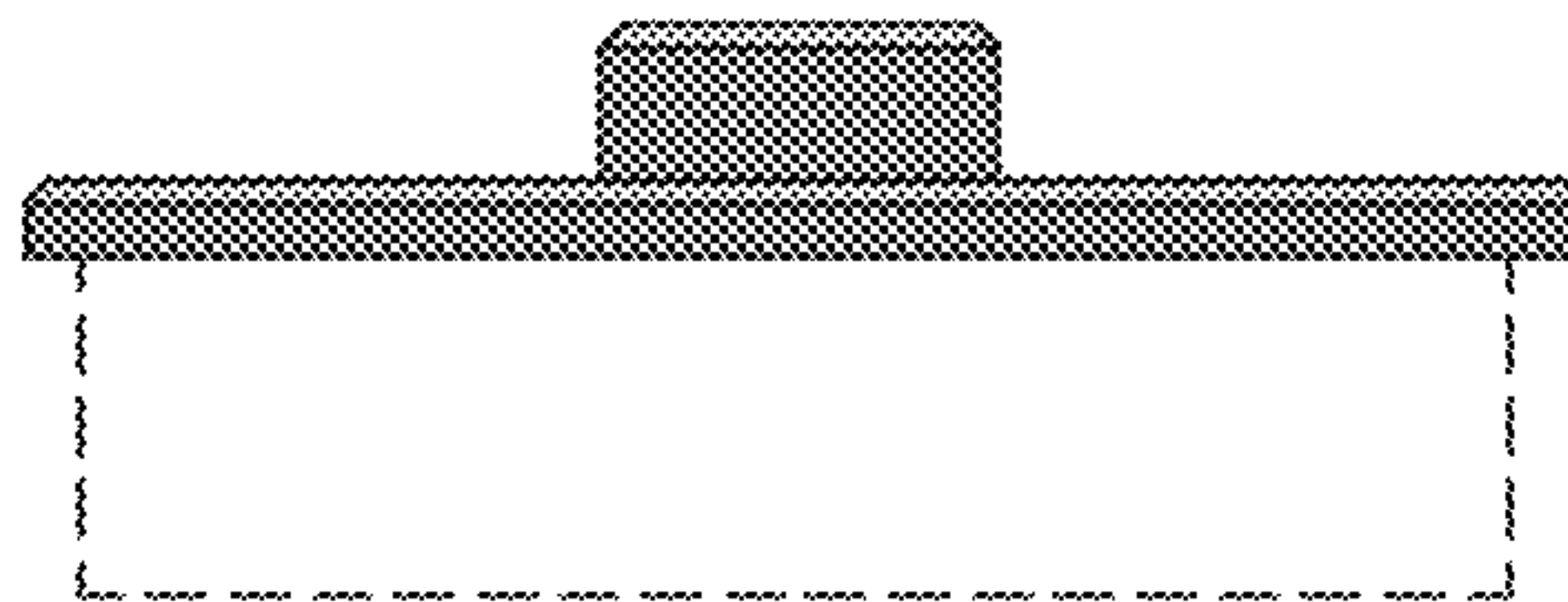

FIG. 48



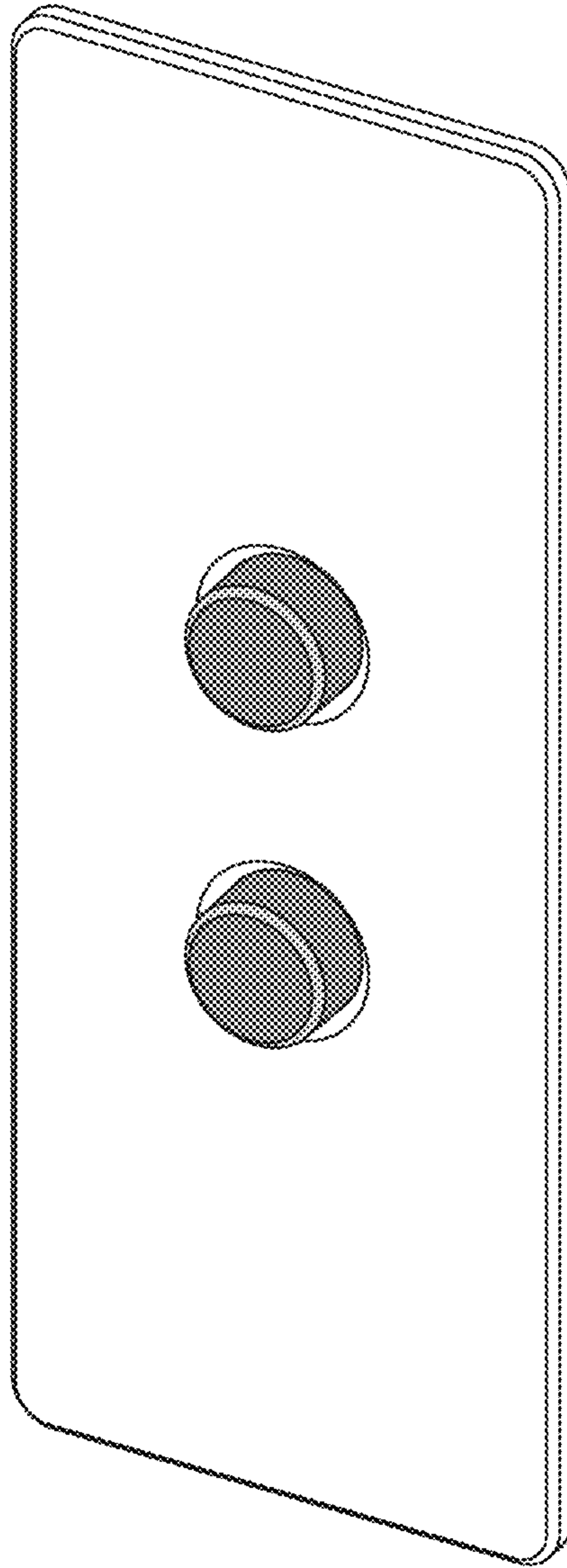

FIG. 49

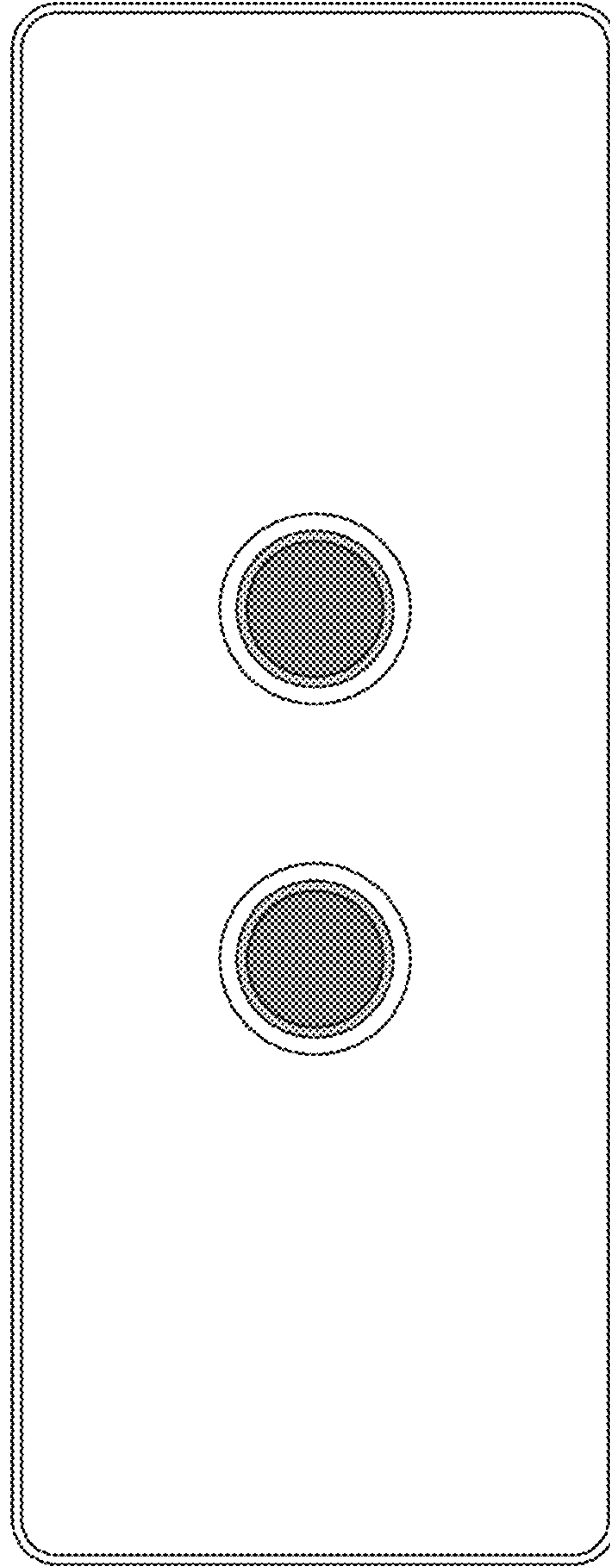

FIG. 50

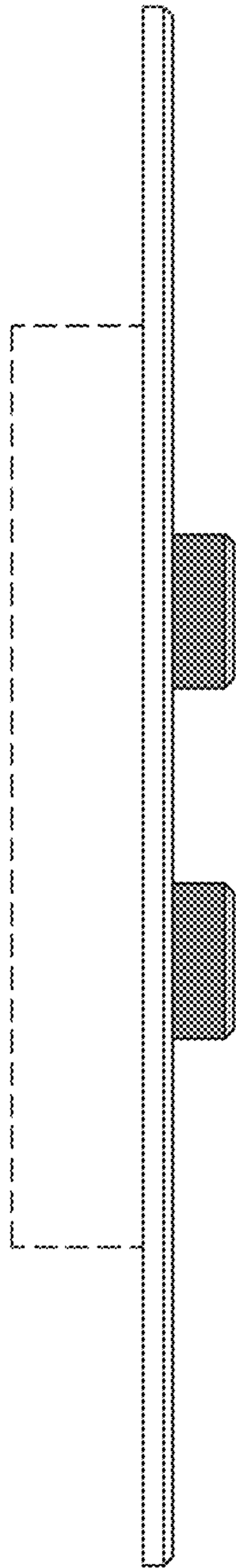

FIG. 51

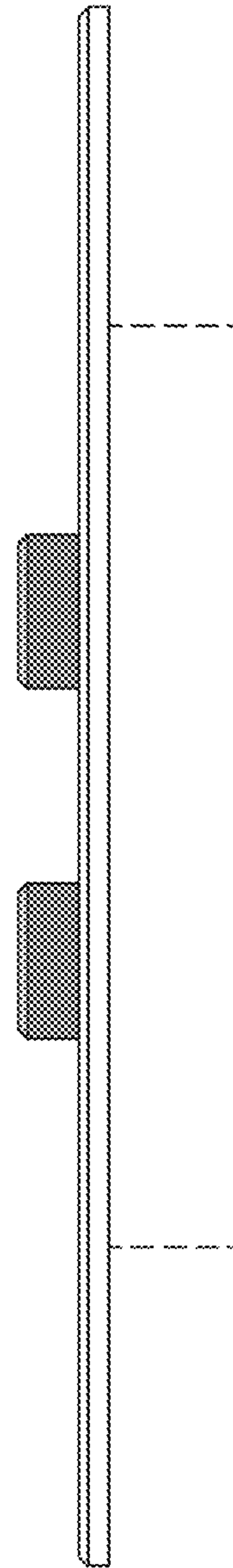

FIG. 52

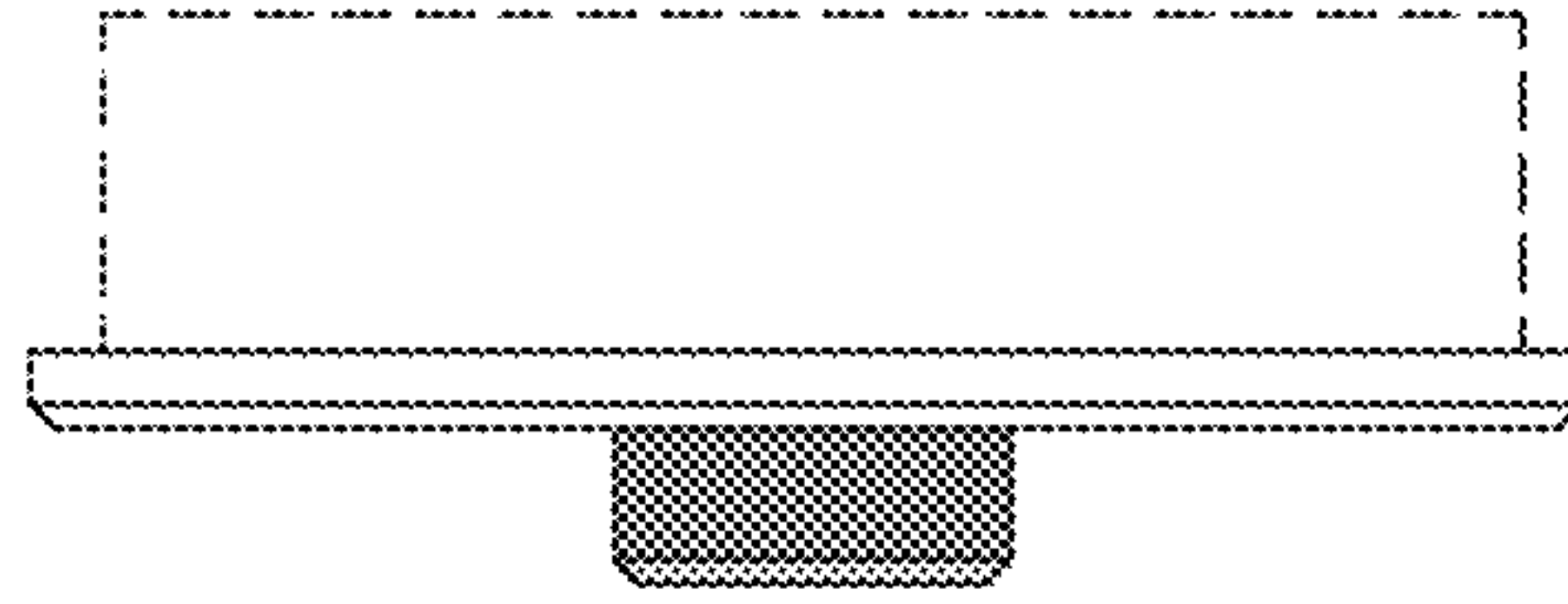

FIG. 53

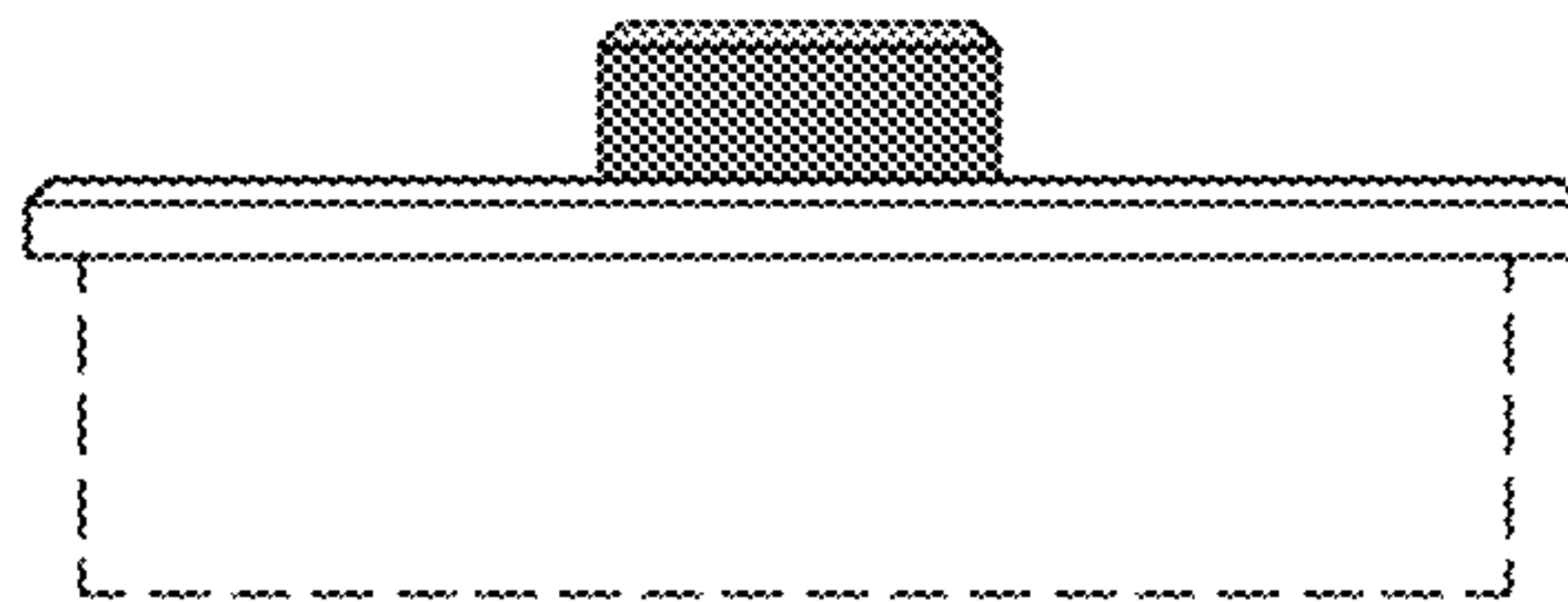

FIG. 54



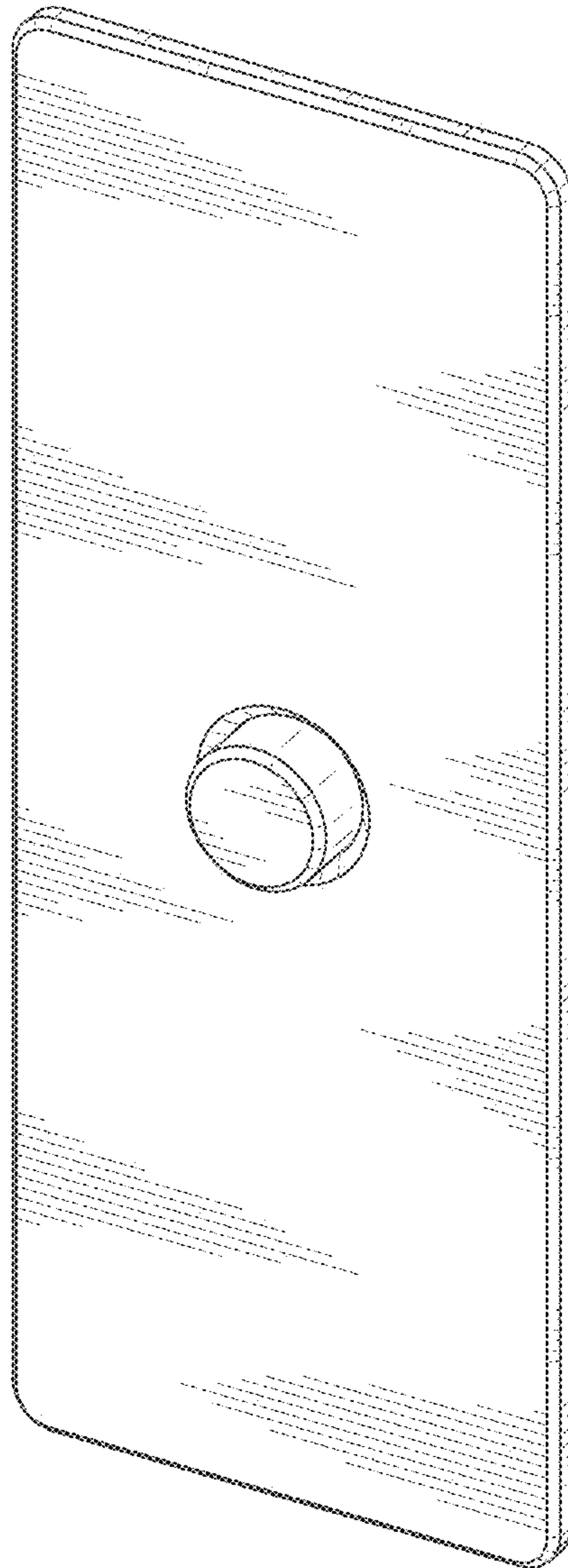

FIG. 55

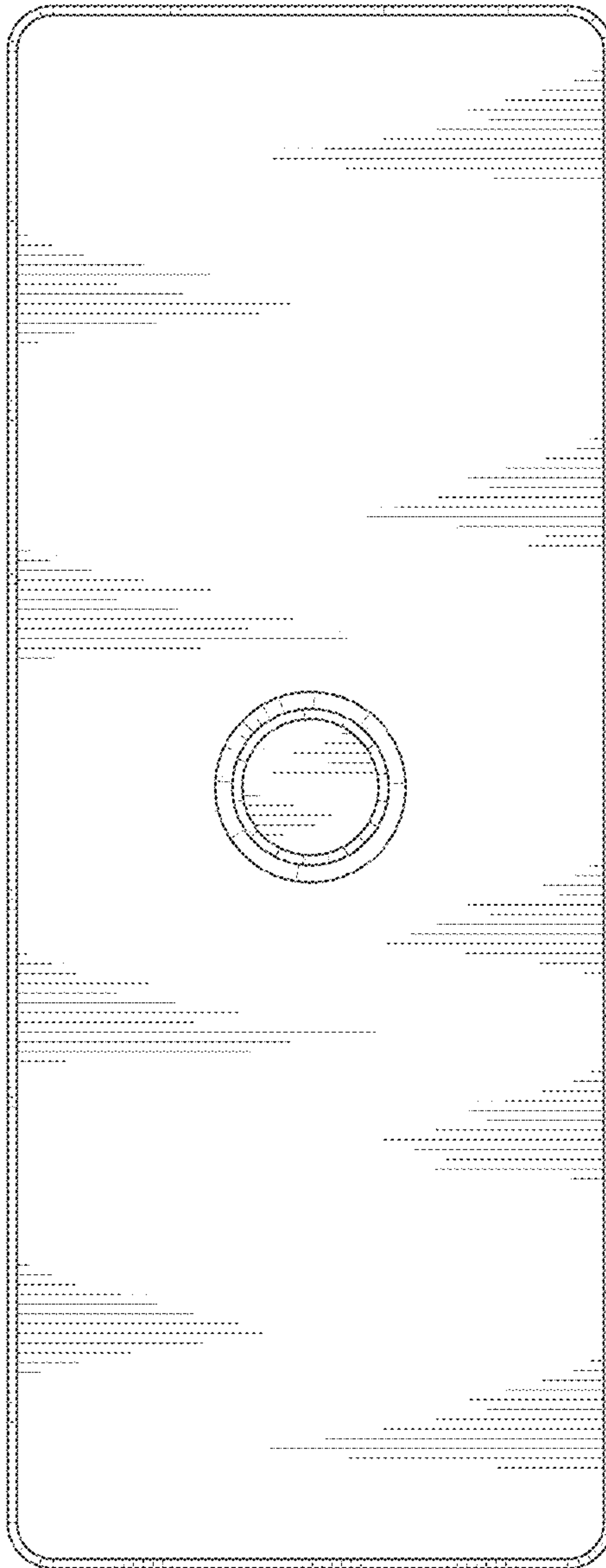

FIG. 56

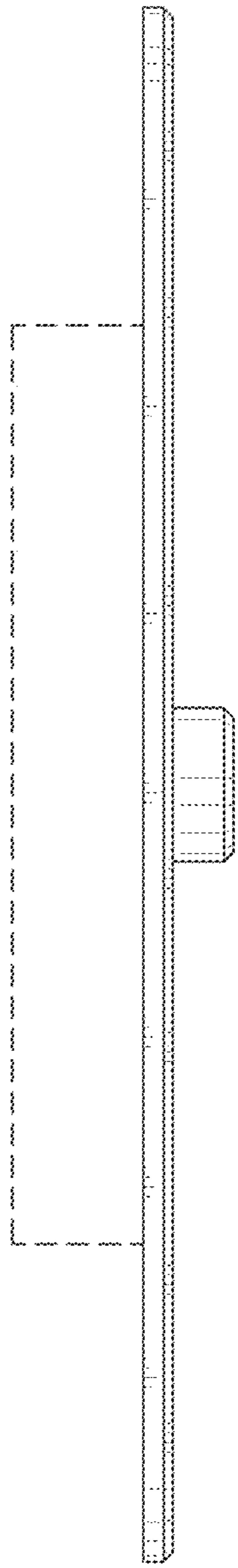

FIG. 57

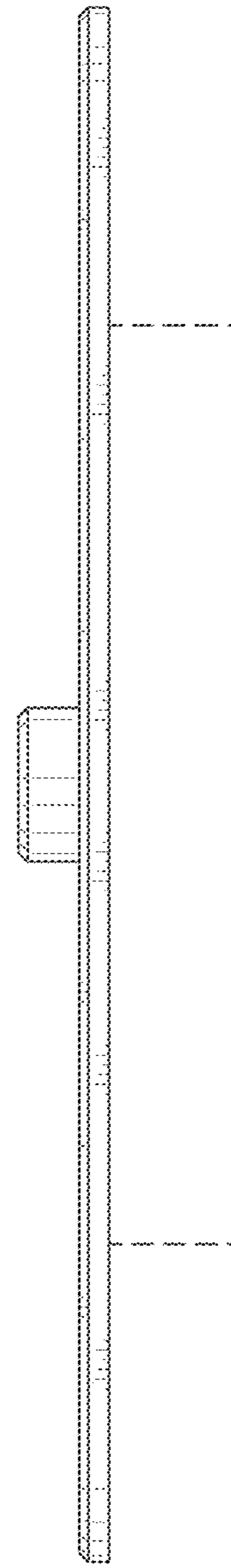

FIG. 58

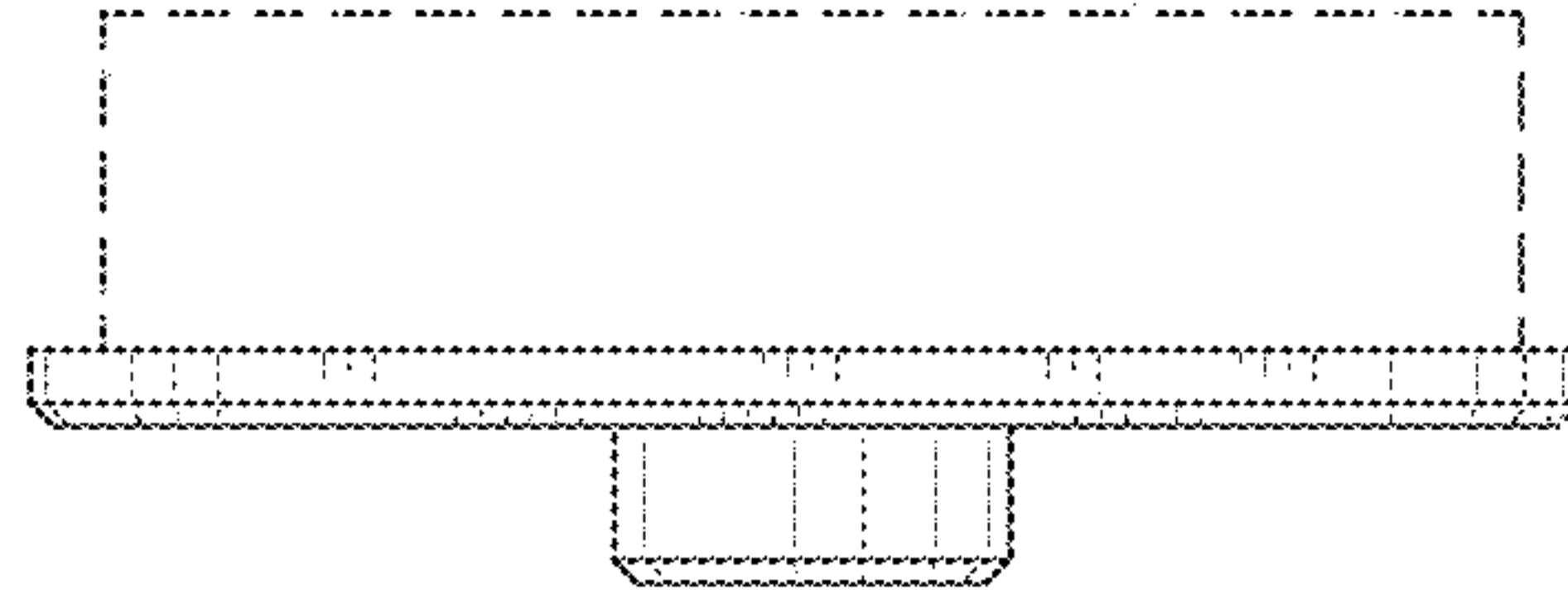

FIG. 59

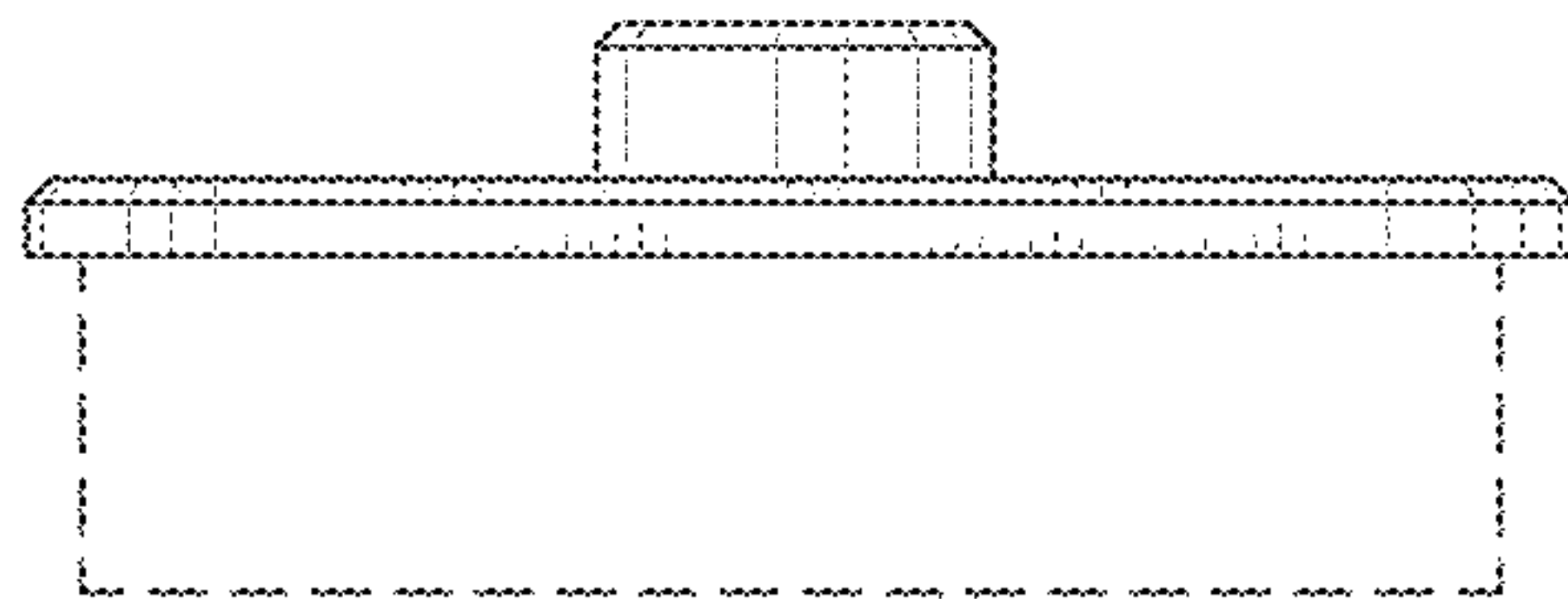

FIG. 60

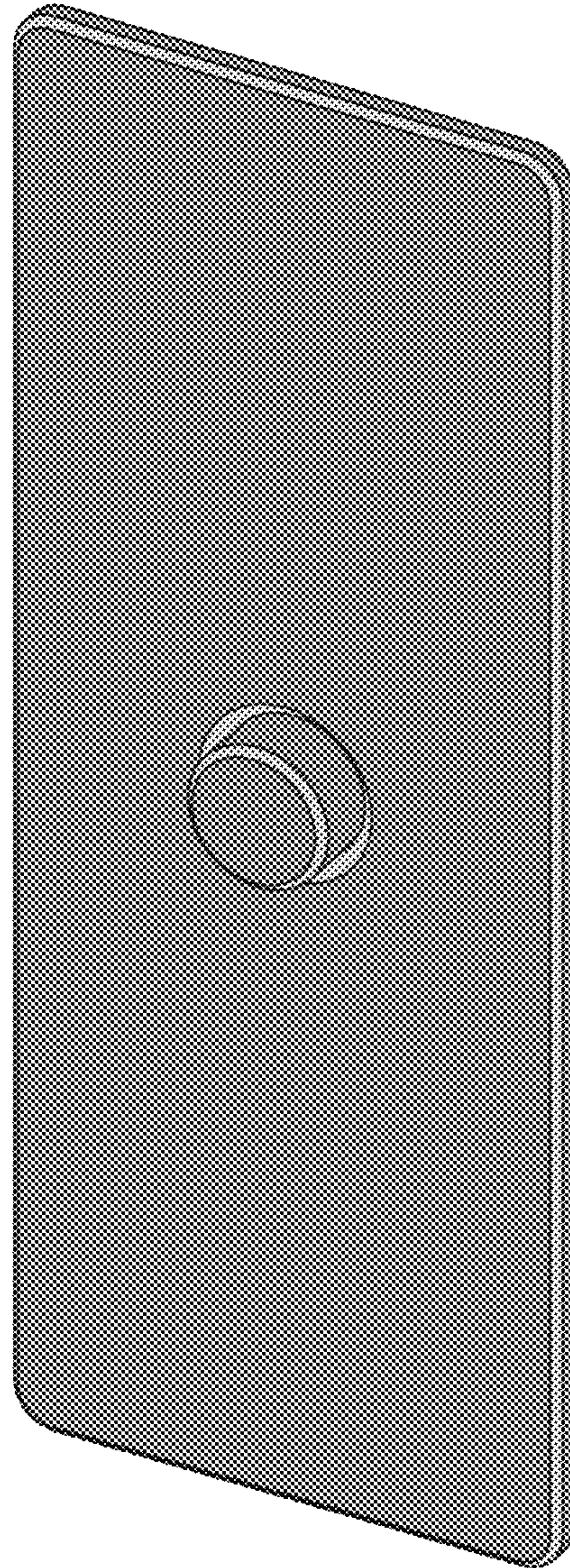

FIG. 61



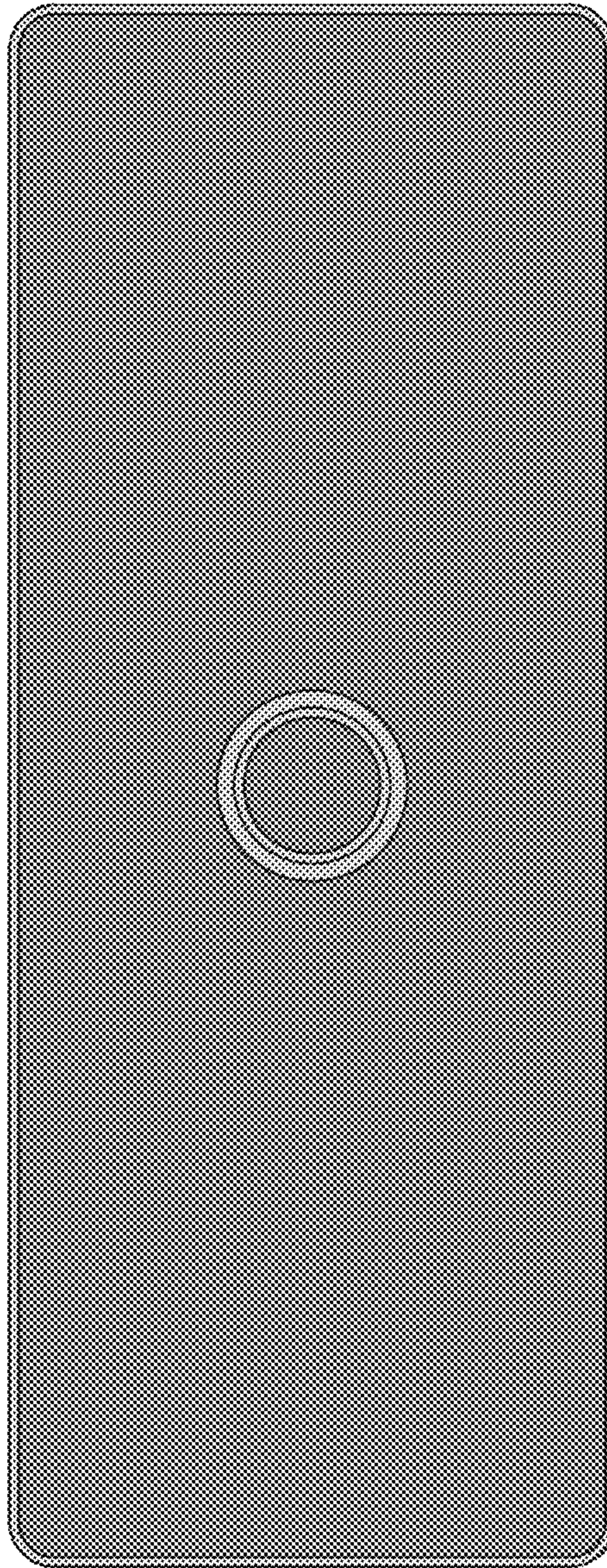

FIG. 62

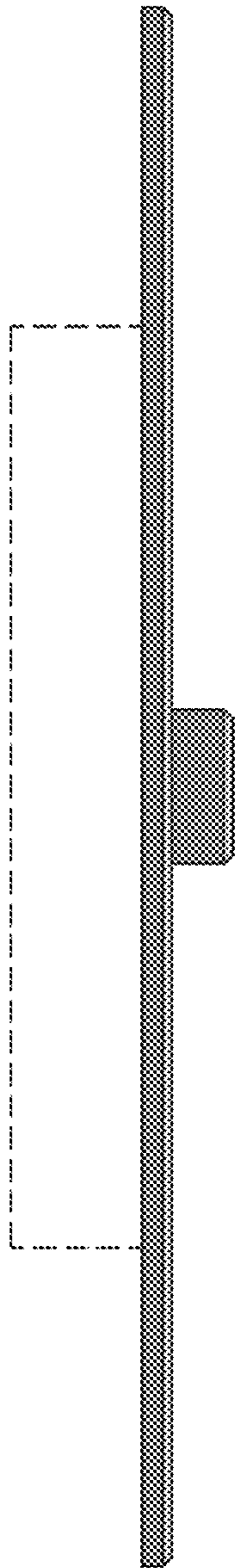

FIG. 63

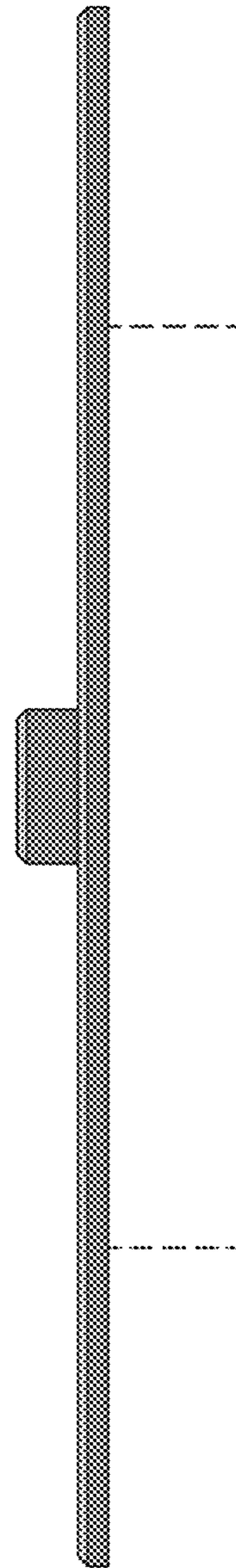

FIG. 64

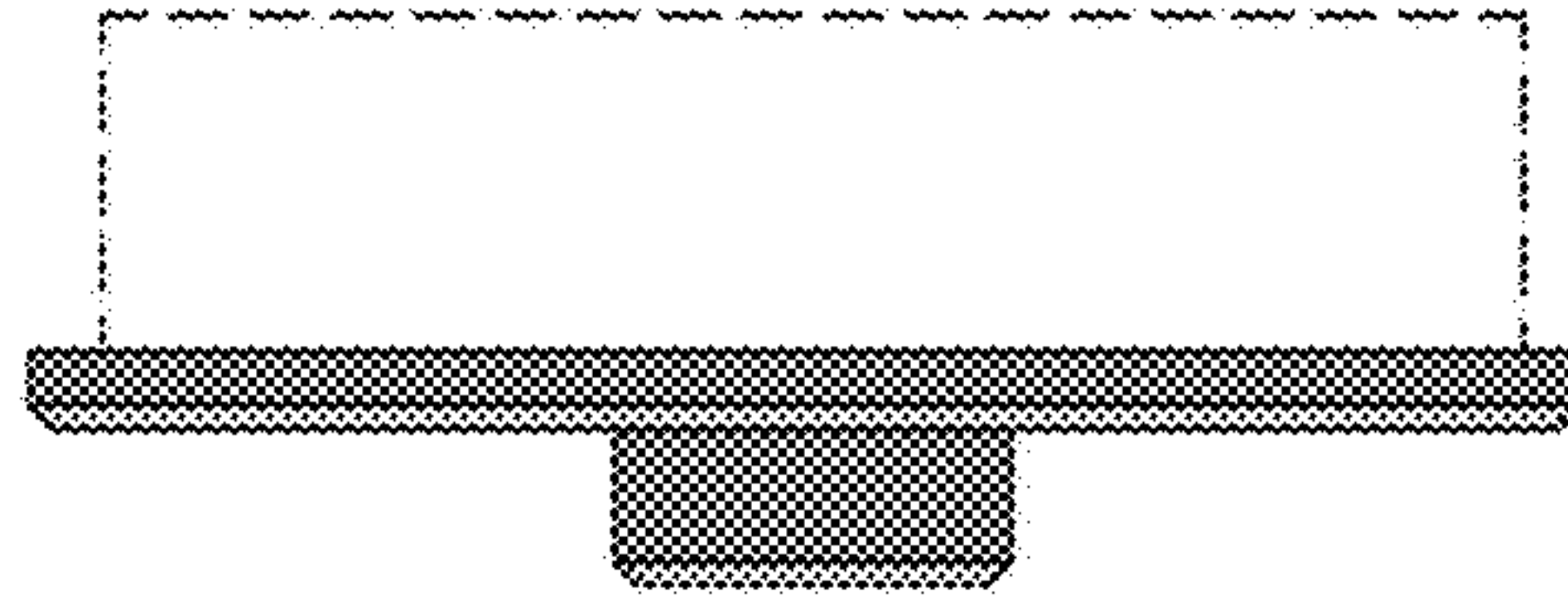

FIG. 65

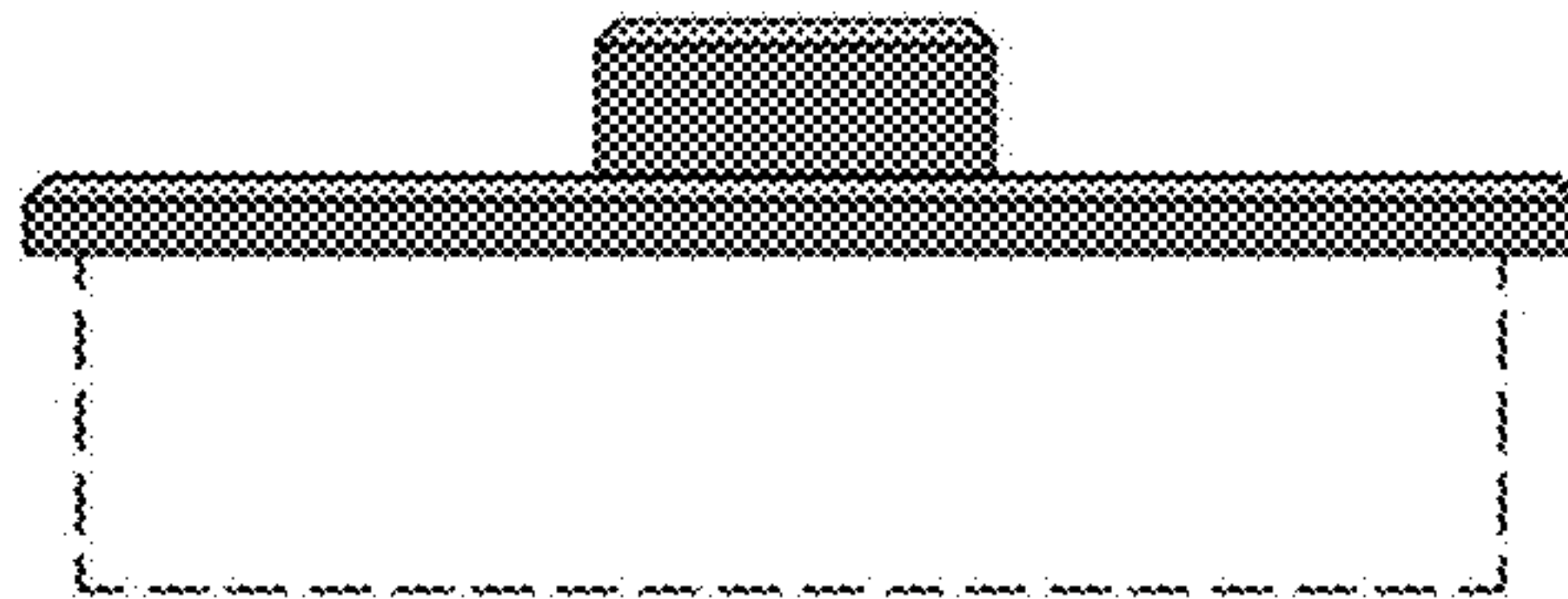

FIG. 66

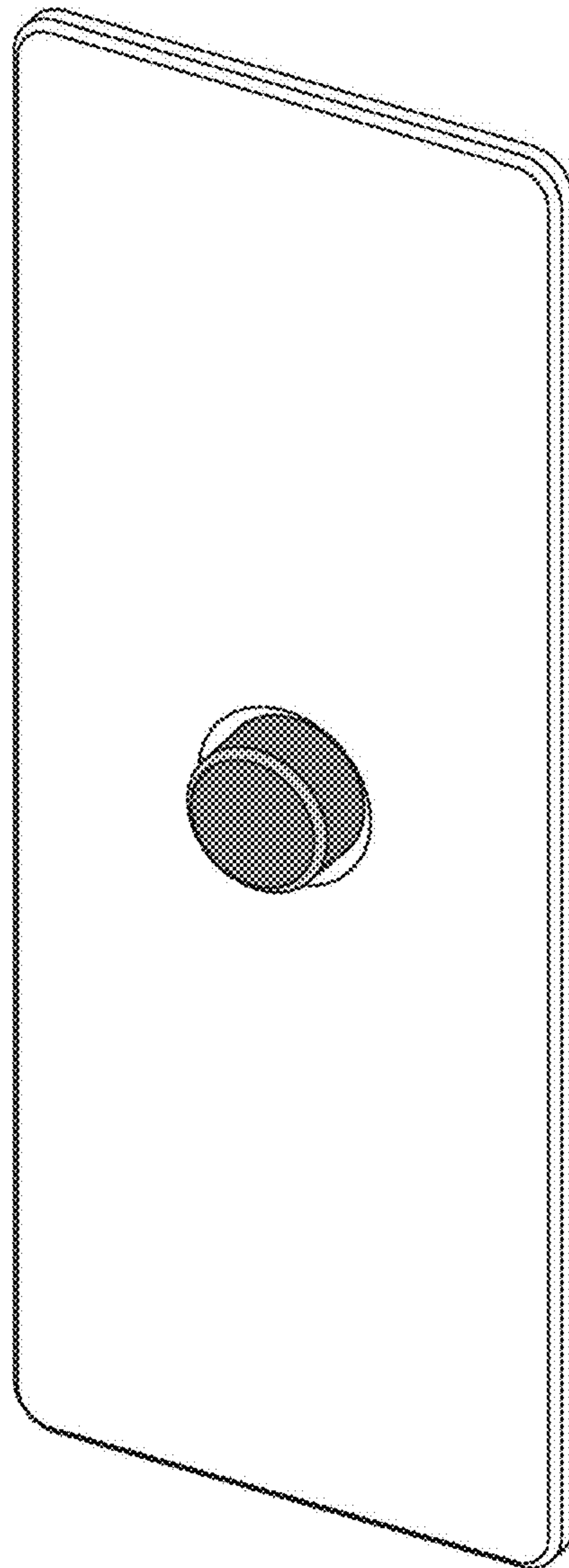

FIG. 67

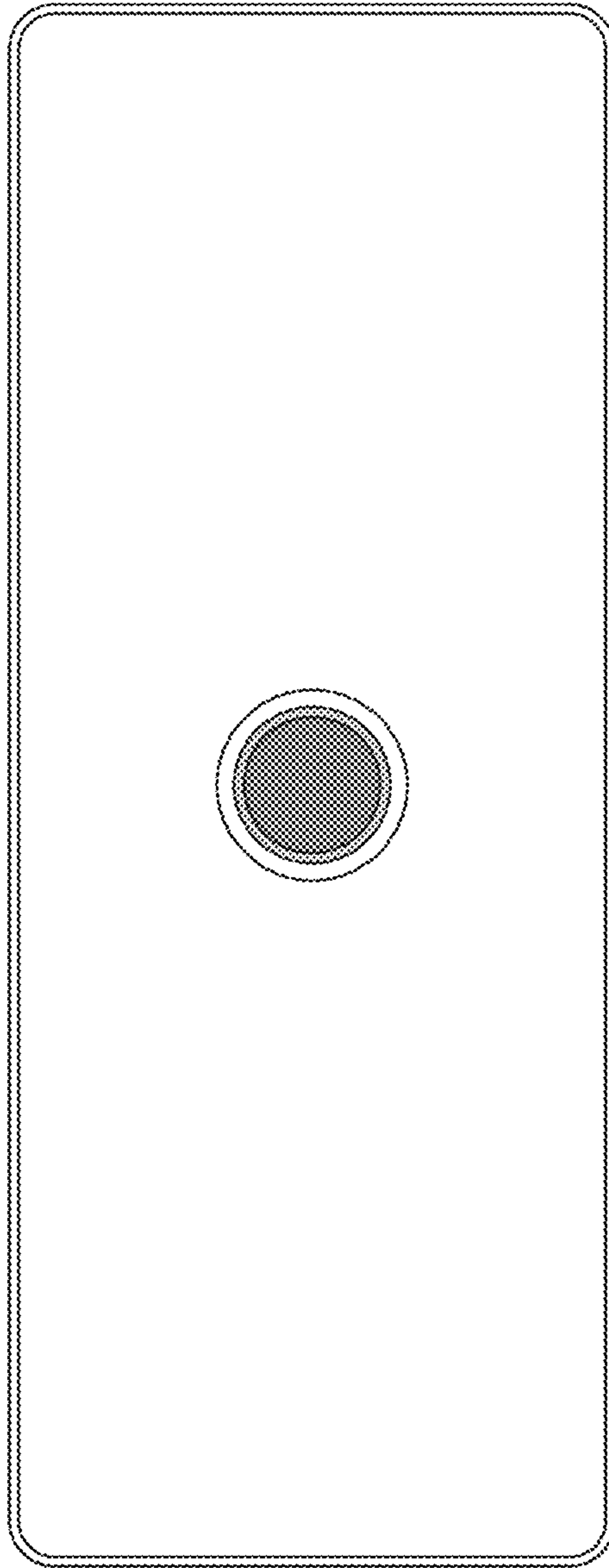

FIG. 68



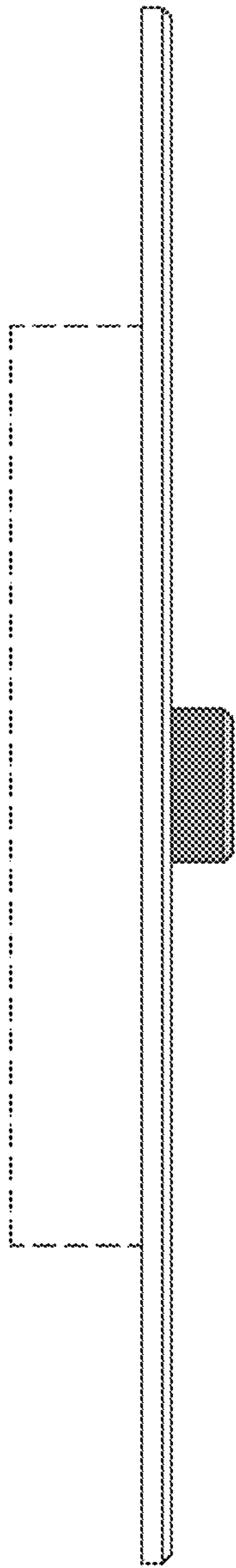

FIG. 69

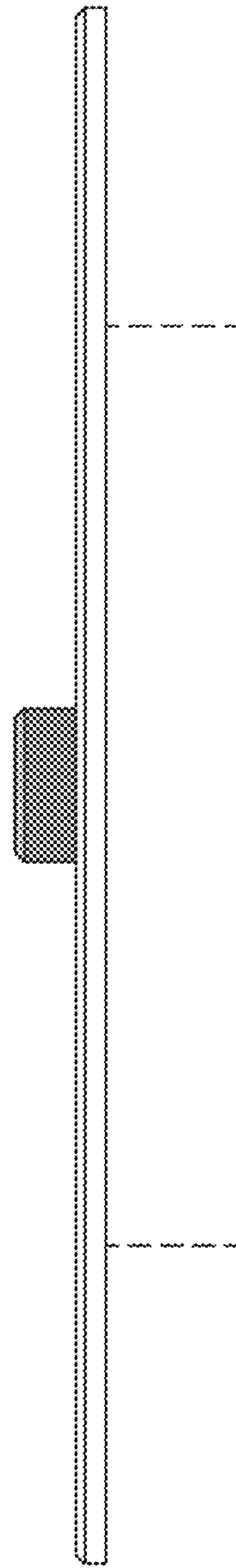

FIG. 70

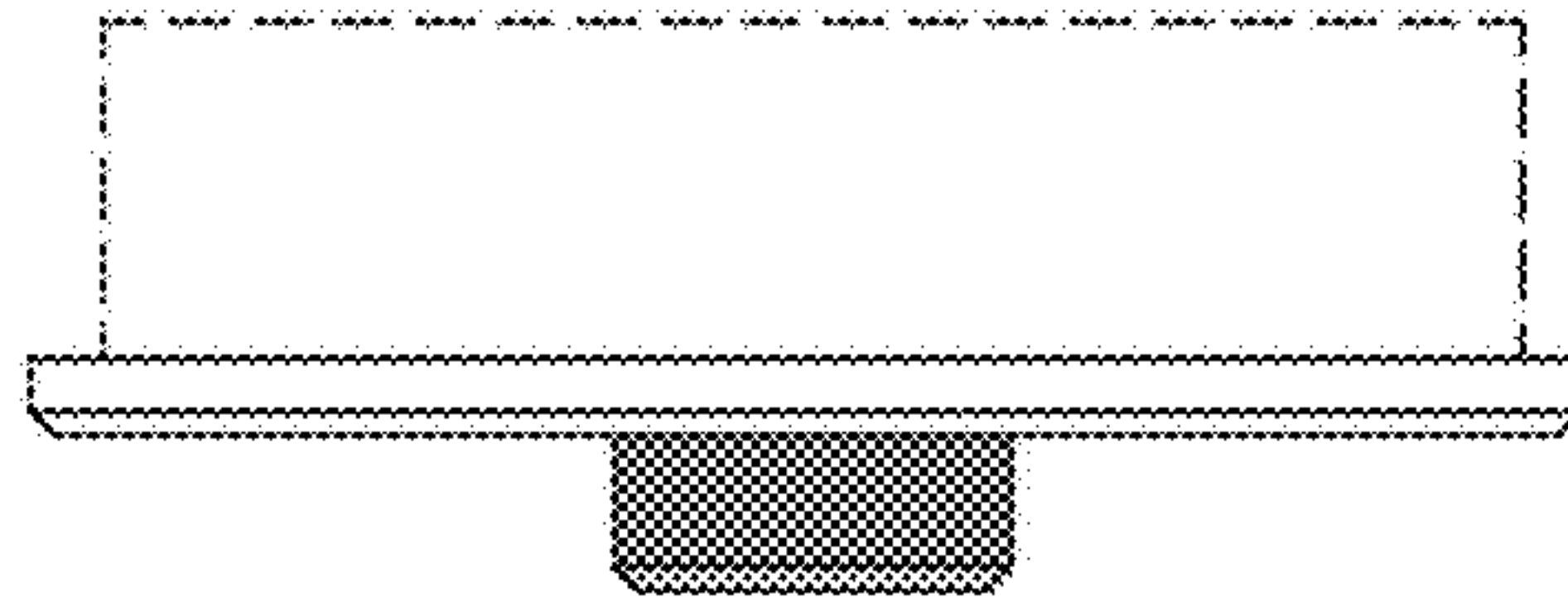

FIG. 71

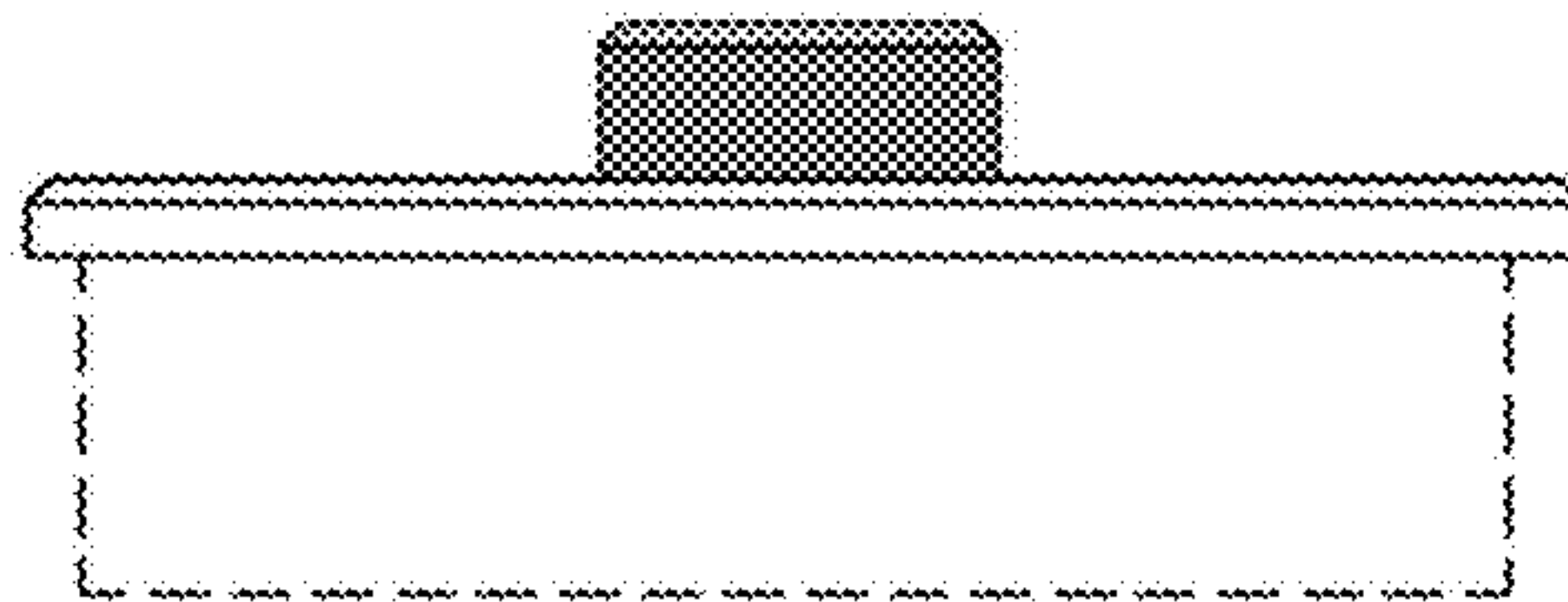

FIG. 72

UNITED STATES PATENT AND TRADEMARK OFFICE  
**CERTIFICATE OF CORRECTION**

PATENT NO. : D921,596 S  
APPLICATION NO. : 29/634284  
DATED : June 8, 2021  
INVENTOR(S) : Gregory S. Altonen et al.

Page 1 of 1

It is certified that error appears in the above-identified patent and that said Letters Patent is hereby corrected as shown below:

On the Title Page

OTHER PUBLICATIONS

Column 2, Line 12:

“q-saturn+horizon+switch&&view-detail&mid-”

Should read:

--“q=saturn+horizon+switch&&view=detail&mid-”--

Column 2, Line 19:

“Op-fXblwa5qSCB9e7olAO&q=push+button+”

Should read:

--“Op-fXblw5qSCB9e7olAO&q=push+button+”--

Column 2, Line 23:

“www.variliht.co.uk”

Should read:

--“www.varilight.co.uk”--

DESCRIPTION

PAGE 2 Column 2, Line 52-53:

“The contour of the buttons in FIGS. 61-72 is same as the contour of the buttons in FIGS. 55-60.”

Should read:

--“The contour of the buttons in FIGS. 61-72 is the same as the contour of the buttons in FIGS. 55-60.”--

Signed and Sealed this  
Third Day of August, 2021



Drew Hirshfeld  
*Performing the Functions and Duties of the  
Under Secretary of Commerce for Intellectual Property and  
Director of the United States Patent and Trademark Office*