



US00D921547S

(12) **United States Design Patent**
Barland et al.

(10) **Patent No.:** **US D921,547 S**
(45) **Date of Patent:** **** Jun. 8, 2021**

- (54) **CALIPER COVER**
- (71) Applicant: **Marshall Genuine Products, LLC**,
Chula Vista, CA (US)
- (72) Inventors: **Michael T. Barland**, Chula Vista, CA
(US); **Aaron Macedo**, Chula Vista, CA
(US)
- (73) Assignee: **MARSHALL GENUINE
PRODUCTS, LLC**, Chula Vista, CA
(US)
- (**) Term: **15 Years**
- (21) Appl. No.: **29/634,428**
- (22) Filed: **Jan. 22, 2018**
- (51) **LOC (13) Cl.** **12-16**
- (52) **U.S. Cl.**
USPC **D12/180**
- (58) **Field of Classification Search**
USPC D12/179, 180, 181, 184, 185, 400
CPC F16D 2055/0016; F16D 65/00; F16D
65/0087; F16D 65/0093; F16D 65/02;
F16D 65/0979
See application file for complete search history.

- D688,609 S * 8/2013 Arbesman D12/180
- D688,610 S * 8/2013 Arbesman D12/180
- D688,996 S * 9/2013 Arbesman D12/180
- D688,997 S * 9/2013 Arbesman D12/180
- D688,998 S * 9/2013 Arbesman D12/180
- 9,046,143 B2 6/2015 Barland
- 9,278,498 B2 3/2016 Collura
- D836,506 S * 12/2018 Arbesman D12/180
- D870,620 S * 12/2019 Hallgren D12/184
- D890,047 S * 7/2020 Bock D12/180

(Continued)

OTHER PUBLICATIONS

“MGP Caliper Covers, SEMA Show booth—Restyling Magazine.”
[online]. MGP Caliper Covers. [Published on Nov. 22, 2011].
Retrieved from the Internet: <<https://www.youtube.com/watch?v=Y-XUwYYtxiY>>.*

(Continued)

Primary Examiner — Khawaja Anwar
Assistant Examiner — Mojtaba Tehrani
(74) *Attorney, Agent, or Firm* — Hahn Loeser & Parks
LLP

(57) **CLAIM**

The ornamental design for a caliper cover, as shown and described.

DESCRIPTION

FIG. 1 is a perspective view of a caliper cover, showing the new design;
FIG. 2 is a top view thereof;
FIG. 3 is a front view thereof;
FIG. 4 is a left side view thereof;
FIG. 5 is a right side view thereof;
FIG. 6 is a rear view thereof; and,
FIG. 7 is a bottom view thereof.
Broken lines in the drawings depict unclaimed portions of the caliper cover and form no part of the claimed design.

1 Claim, 3 Drawing Sheets

(56) **References Cited**
U.S. PATENT DOCUMENTS

- 3,605,956 A 9/1971 Hahn et al.
- D252,458 S * 7/1979 Laine D12/184
- D372,449 S * 8/1996 Becker D12/184
- D476,275 S * 6/2003 Winkler F16D 55/22
D12/180
- D482,993 S * 12/2003 Conway D12/184
- D515,484 S * 2/2006 Winkler D12/180
- D579,835 S * 11/2008 Vanaria D12/181
- D579,836 S * 11/2008 Vanaria D12/181
- D579,837 S * 11/2008 Vanaria D12/181
- D625,231 S * 10/2010 Suzuki D12/180
- D647,016 S * 10/2011 Medina D12/181
- D688,608 S 8/2013 Amy

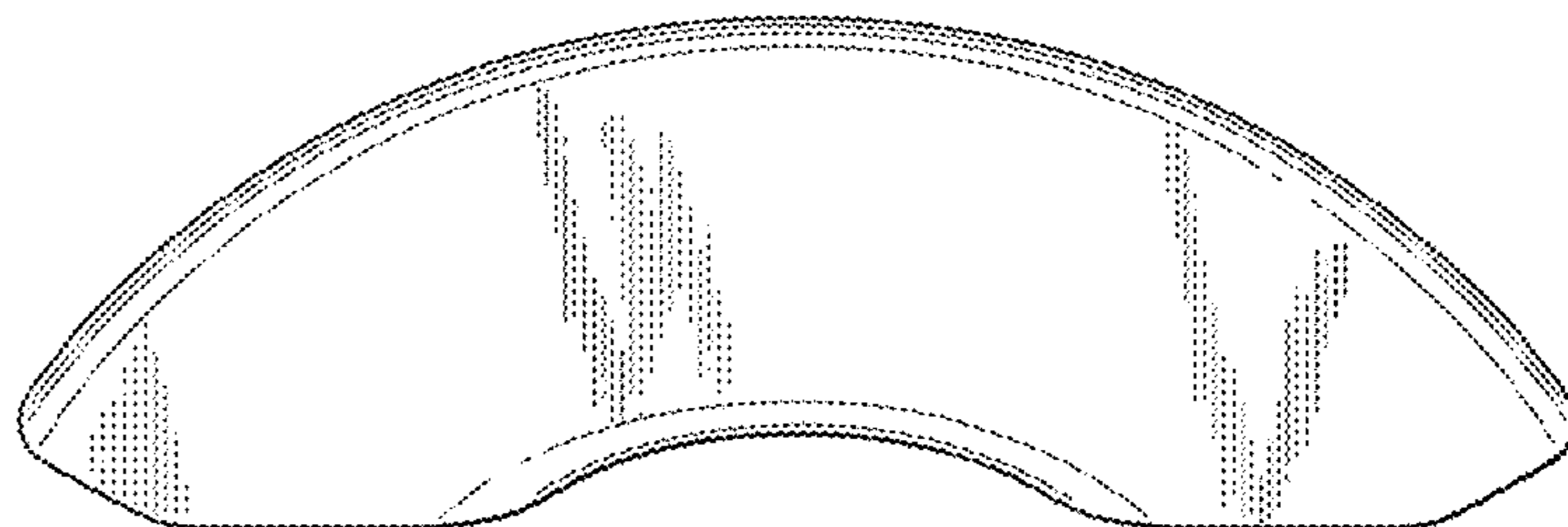
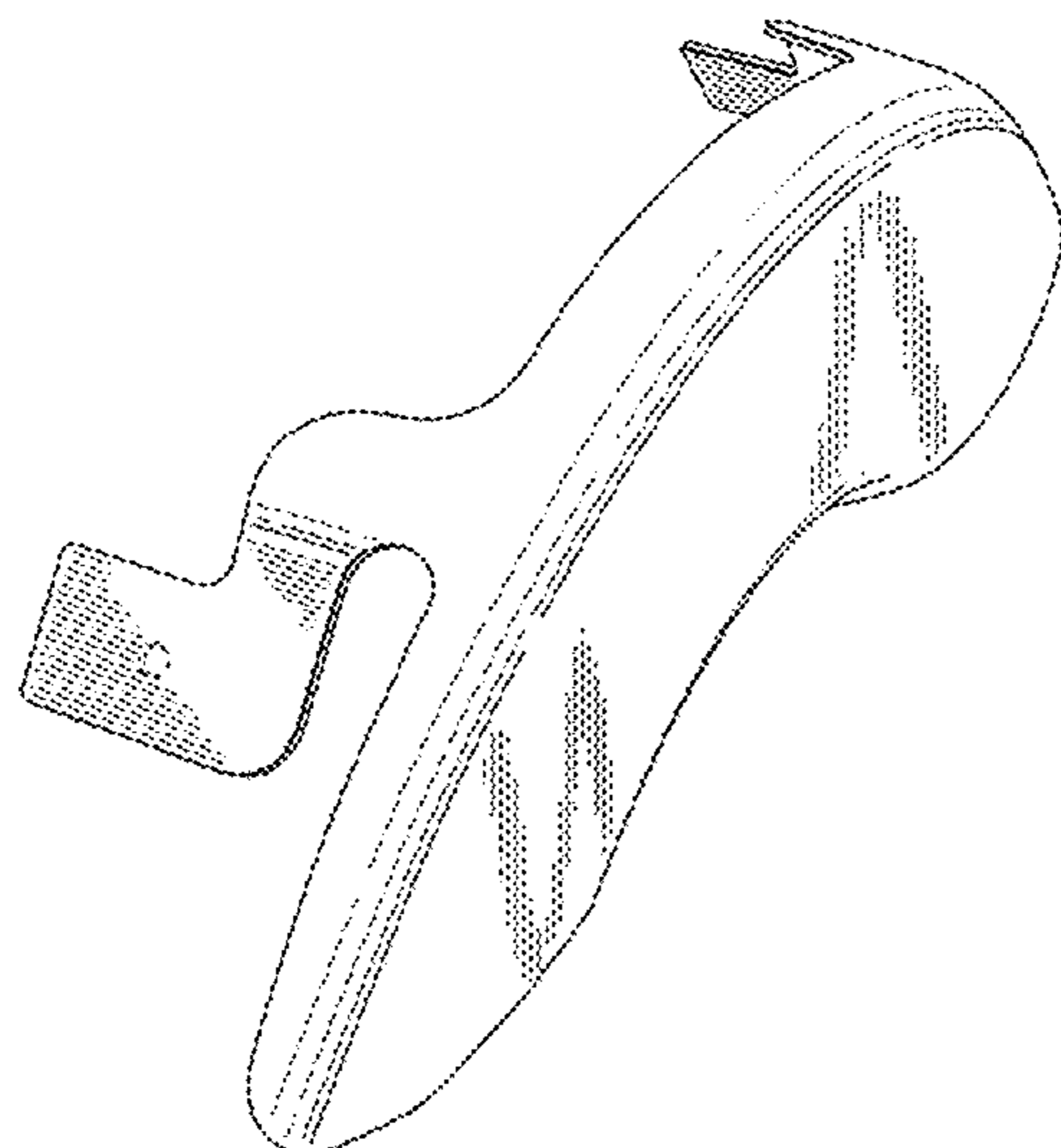

(56)

References Cited

U.S. PATENT DOCUMENTS

D907,546 S * 1/2021 Bock D12/180
2004/0016610 A1 1/2004 Morris
2004/0074716 A1 4/2004 Brumfield et al.
2005/0258008 A1 11/2005 King

OTHER PUBLICATIONS

“MGP Caliper Covers on Motortrend Performance TV” [online]. MGP Caliper Covers. [Published on Mar. 10, 2020]. Retrieved from the Internet: <<https://www.youtube.com/watch?v=SYQAJqlMcSQ>>.*
“MGP Caliper Covers 42020SJEPD Set of 4 Caliper Covers [. . .]” [online]. MGP Caliper Covers. [Product first available on Aug. 24, 2018]. Retrieved from the Internet: <<https://www.amazon.com/dp/B07GT72F12>>.*

* cited by examiner

Fig. 1

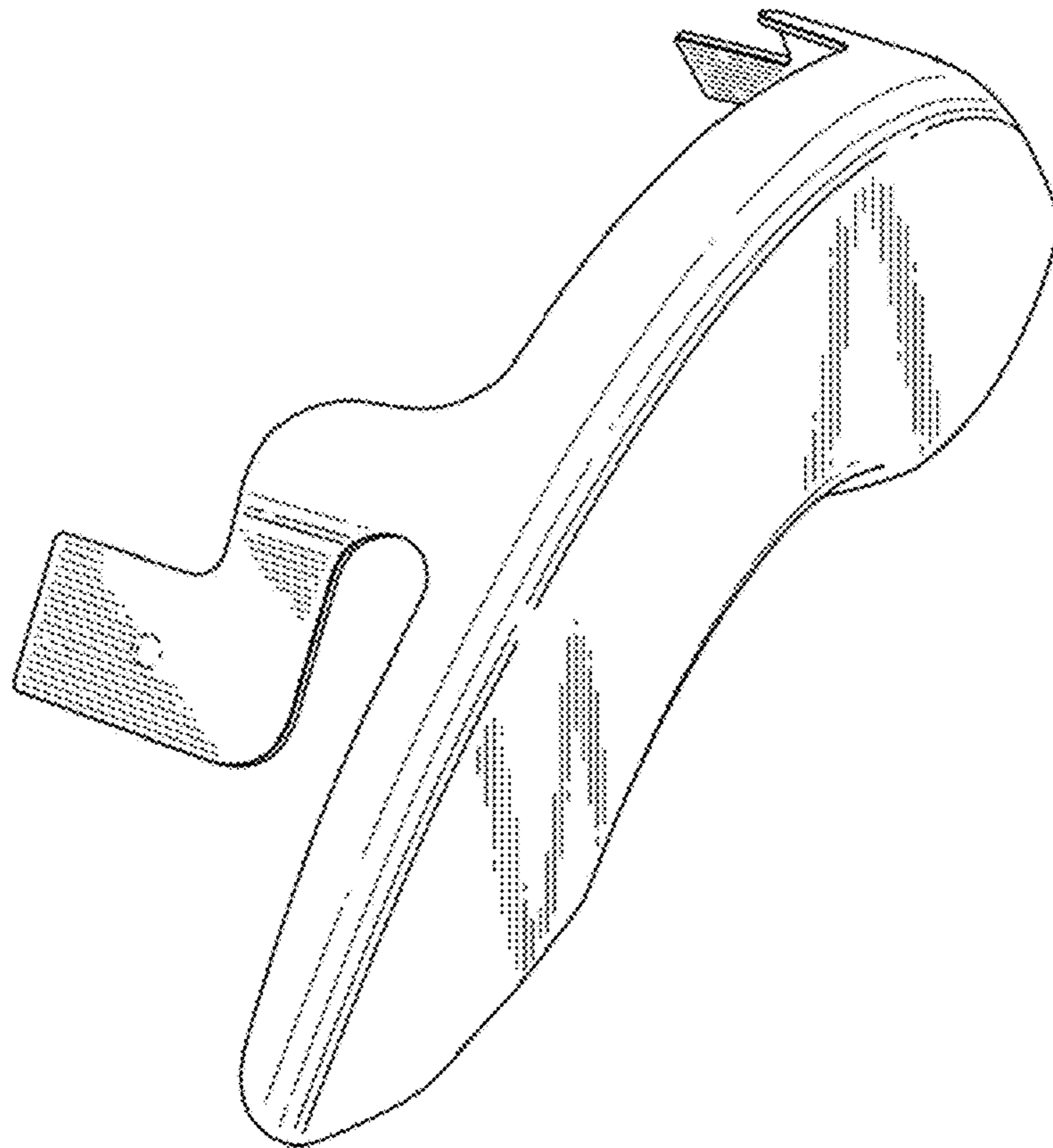

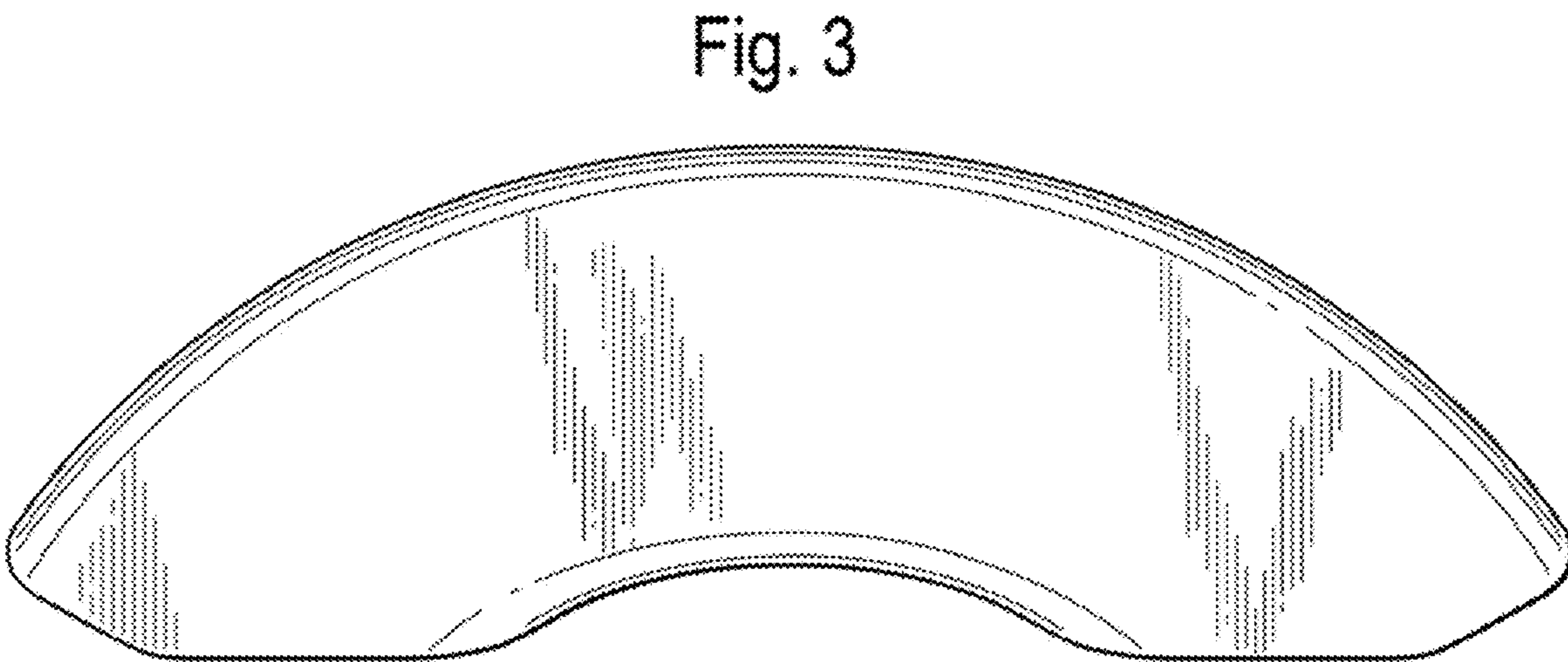
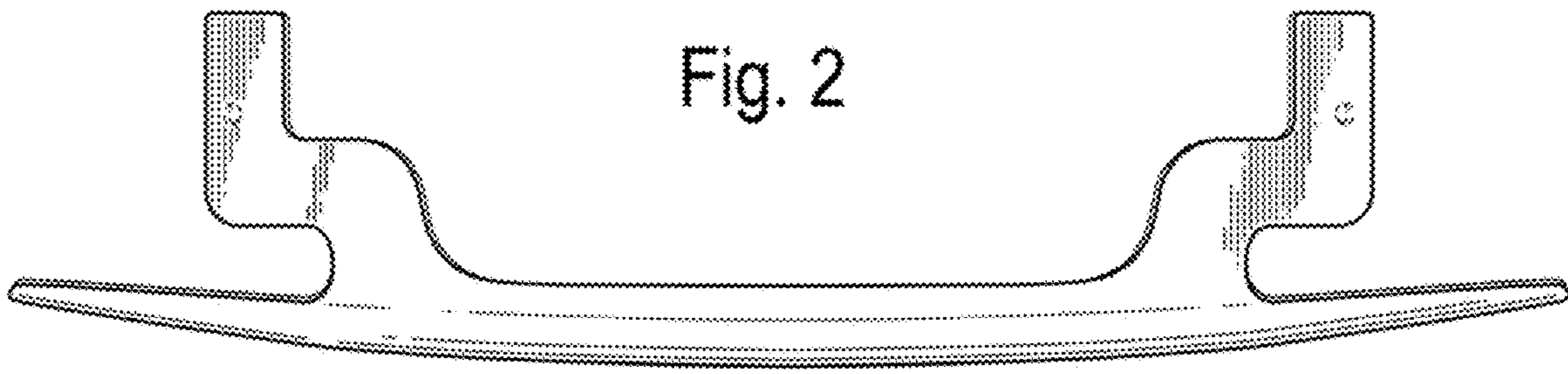

Fig. 4

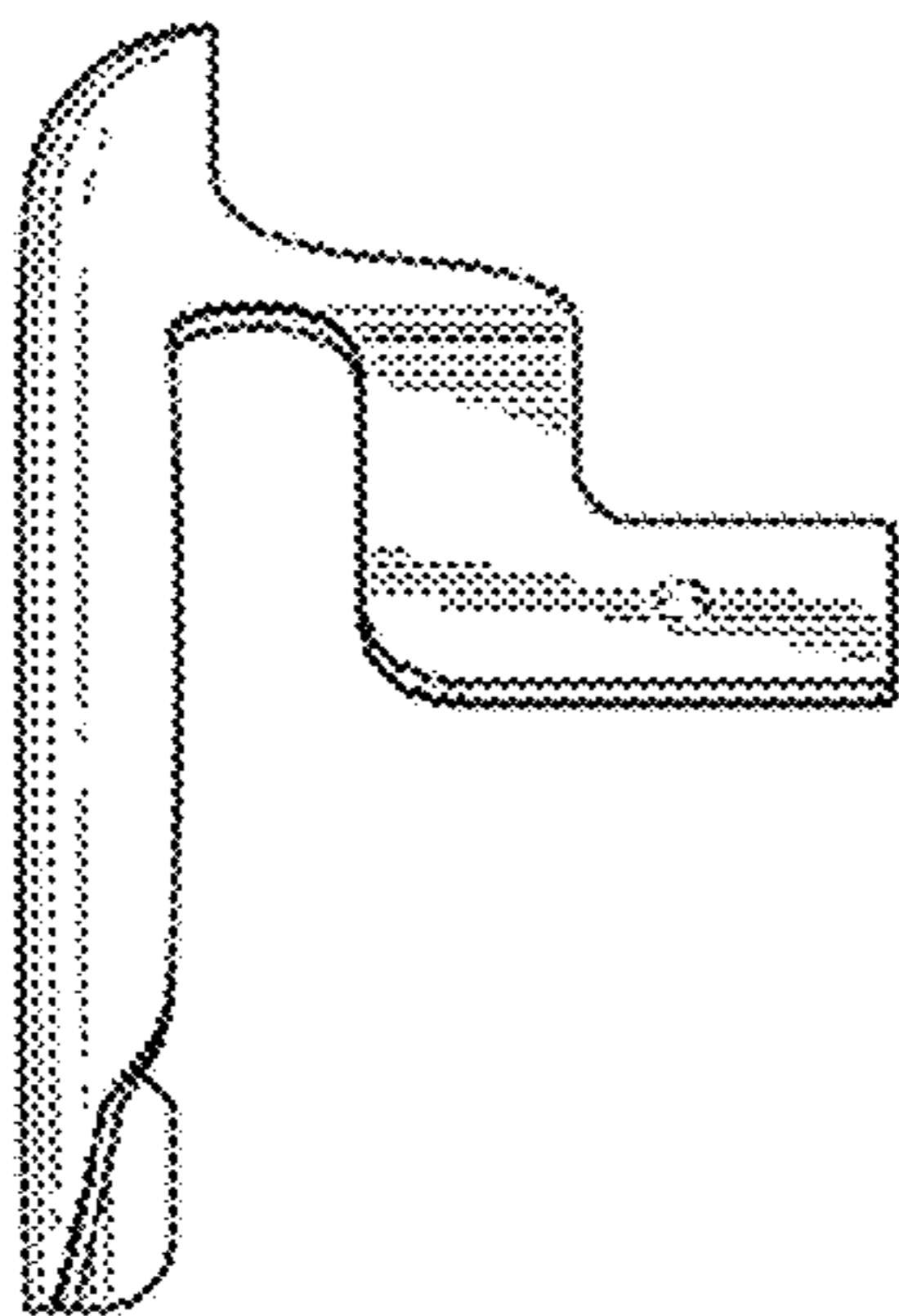

Fig. 5

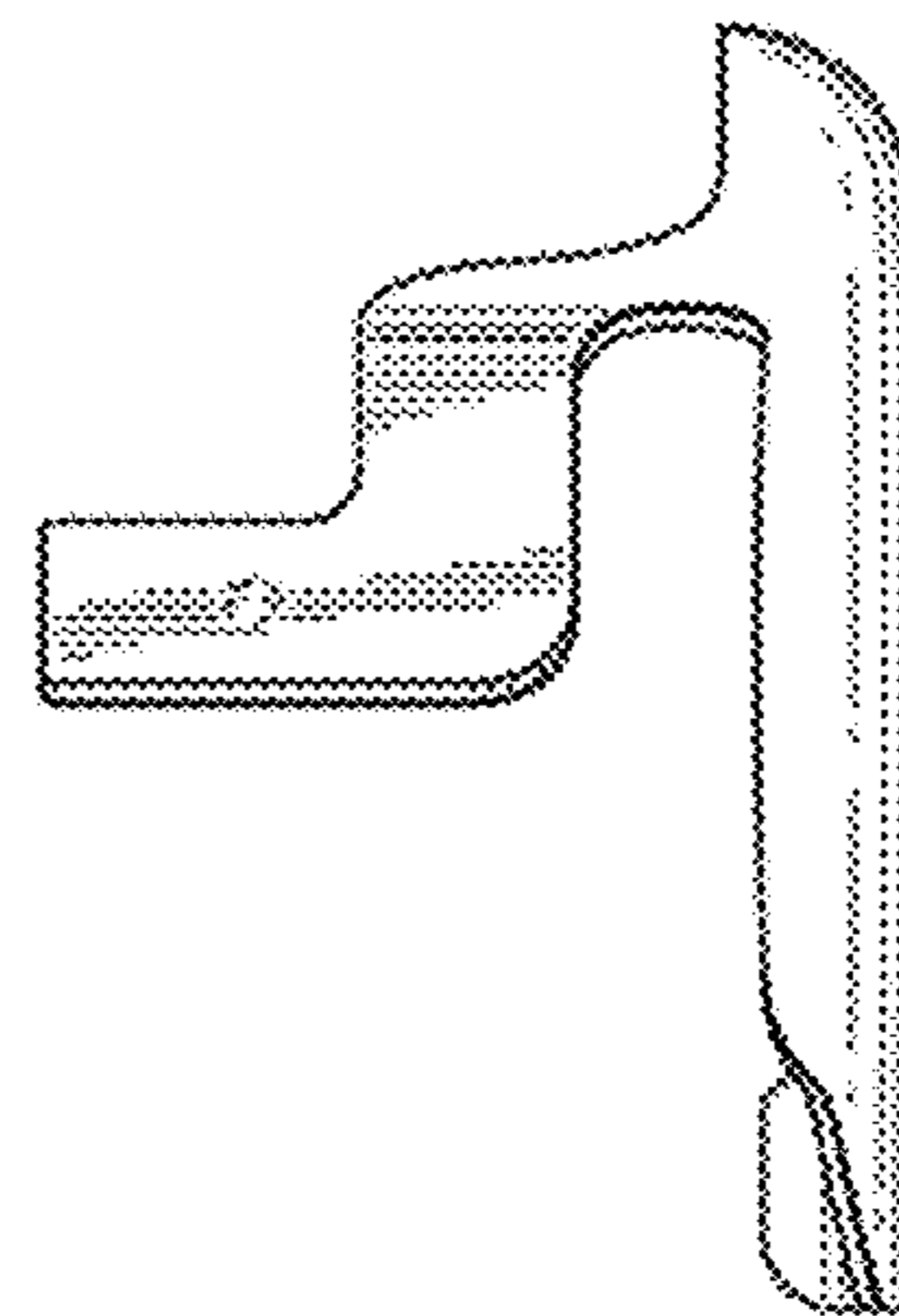

Fig. 6

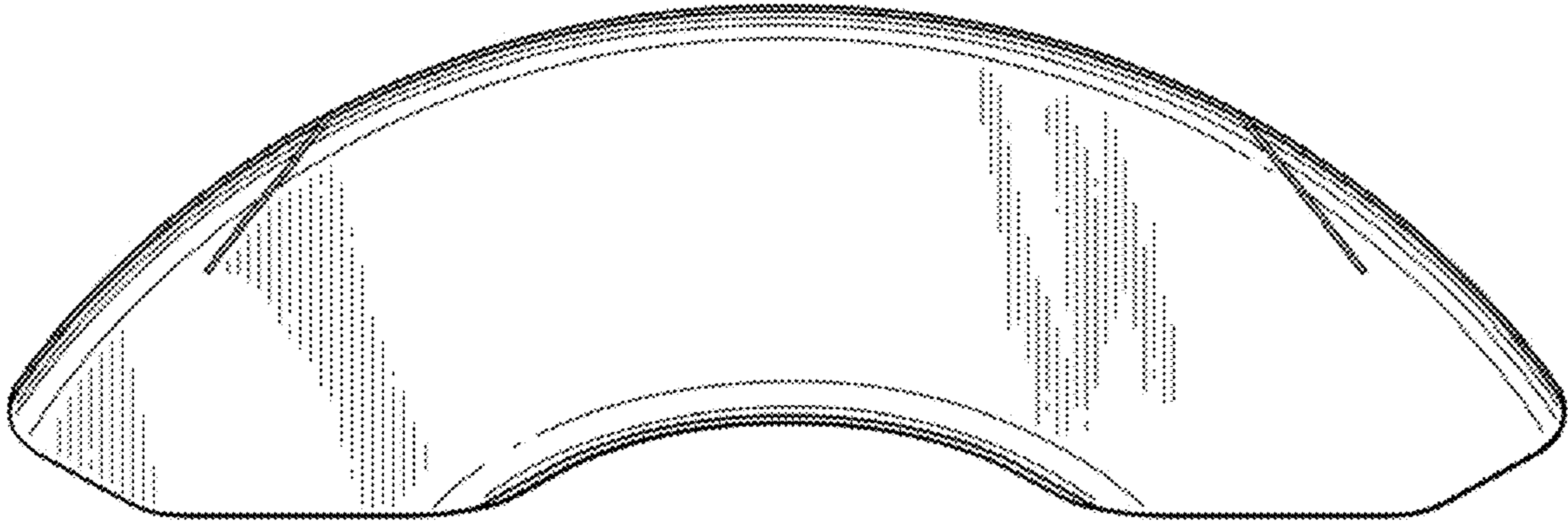

Fig. 7

