



US00D921534S

(12) **United States Design Patent**
Niznik

(10) **Patent No.:** **US D921,534 S**

(45) **Date of Patent:** **** Jun. 8, 2021**

(54) **MOTORCYCLE**

(71) Applicant: **Nmoto, Inc.**, North Miami, FL (US)

(72) Inventor: **Robert Grant Niznik**, Miami Gardens, FL (US)

(73) Assignee: **NMOTO, Inc.**, North Miami, FL (US)

(**) Term: **15 Years**

(21) Appl. No.: **29/687,784**

(22) Filed: **Apr. 16, 2019**

(51) **LOC (13) Cl.** **12-11**

(52) **U.S. Cl.**
USPC **D12/110**

(58) **Field of Classification Search**

USPC D12/110, 111, 117; D21/432, 538
CPC B62K 11/00; B62K 11/02; B62K 11/04;
B62K 11/10; B62K 17/00; B62K 19/00;
B62K 2202/00

See application file for complete search history.

(56) **References Cited**

U.S. PATENT DOCUMENTS

4,809,800 A * 3/1989 Suzuki B62K 11/00
180/219
D384,916 S * 10/1997 Rodriguez Ferre D12/110
D426,174 S * 6/2000 Sofue D12/110

D444,419 S * 7/2001 Kamata D12/110
D476,271 S * 6/2003 Abe D12/110
D605,982 S * 12/2009 Tanaka D12/110
D624,853 S * 10/2010 Song D12/110
D656,867 S * 4/2012 Uemoto D12/110
D666,531 S * 9/2012 Dunshee D12/110
D691,069 S * 10/2013 Tsukui D12/110
D692,355 S * 10/2013 Tsuji D12/110
D722,538 S * 2/2015 Song D12/110
D735,616 S * 8/2015 Tako D12/110

* cited by examiner

Primary Examiner — Darlington Ly

(74) *Attorney, Agent, or Firm* — McHale & Slavin, P.A.

(57) **CLAIM**

The ornamental design for motorcycle, as shown and described.

DESCRIPTION

FIG. 1 is a front and left side perspective view of a motorcycle embodying my new design;

FIG. 2 is a rear and left side perspective view thereof;

FIG. 3 is a right side elevation view thereof;

FIG. 4 is a left side elevation view thereof;

FIG. 5 is a front elevation view thereof;

FIG. 6 is a rear elevation view thereof; and,

FIG. 7 is a top plan view thereof.

The broken lines in the drawings illustrate portions of the motorcycle that form no part of the claimed design.

1 Claim, 6 Drawing Sheets

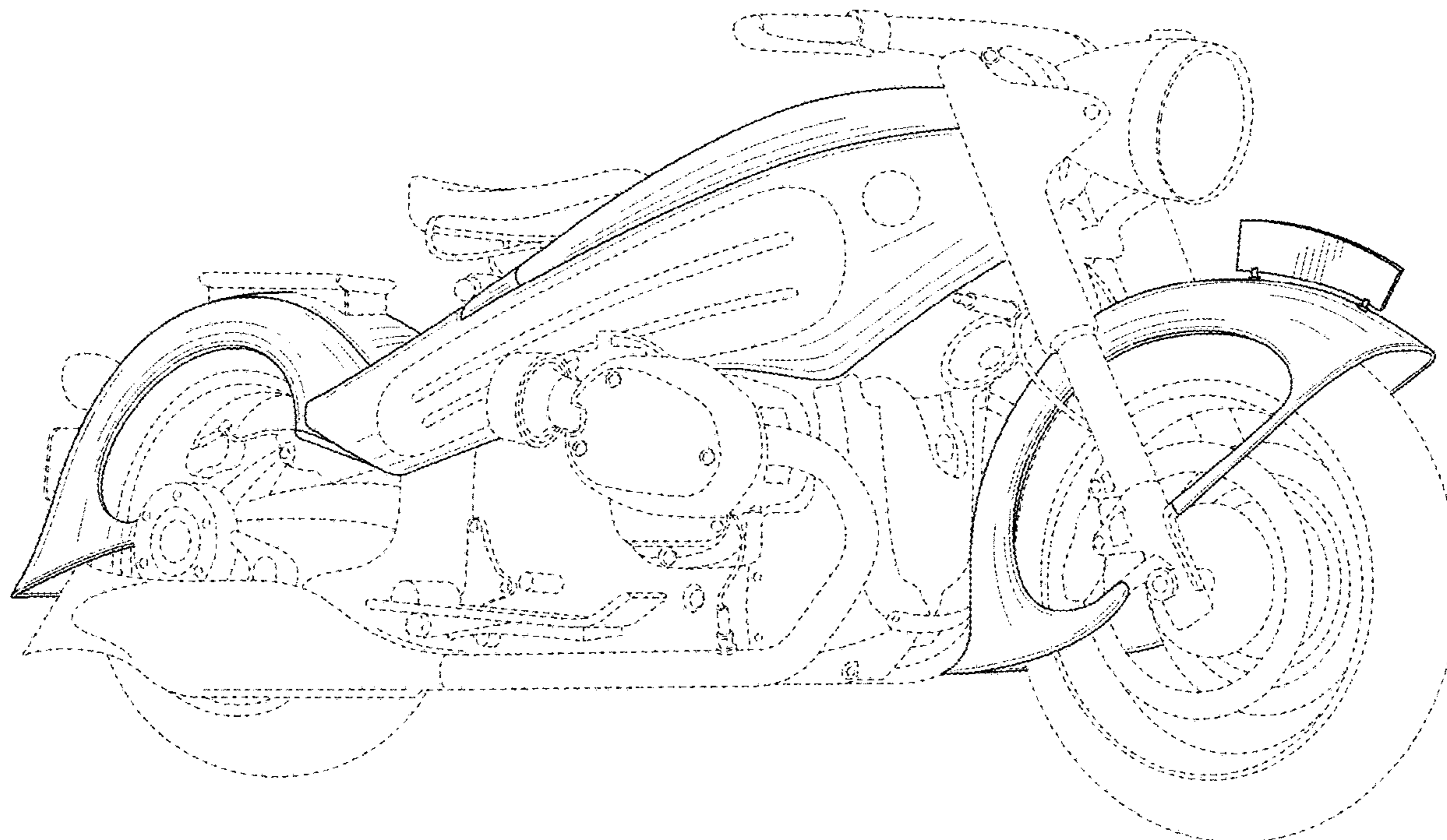

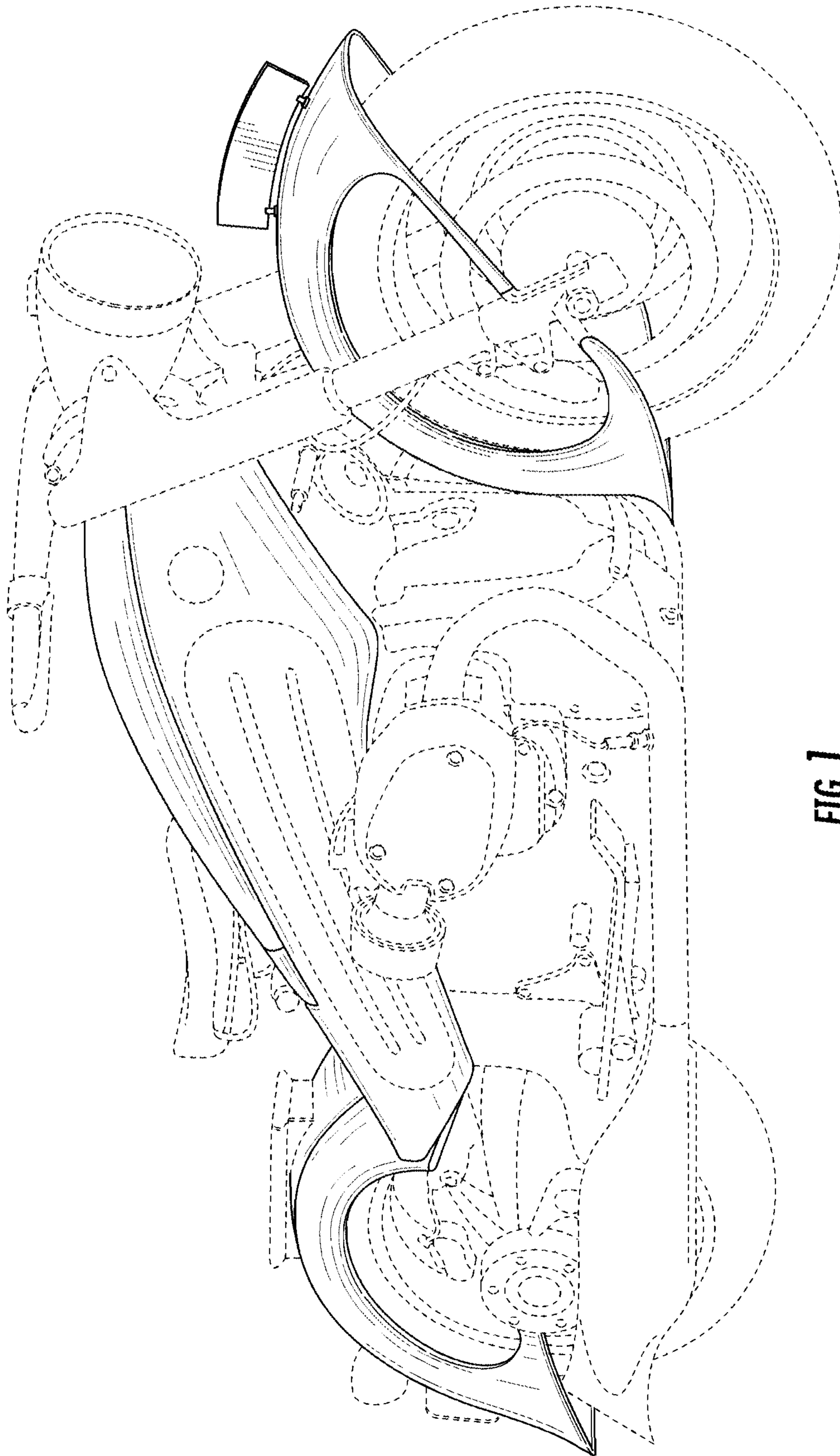

FIG. 1

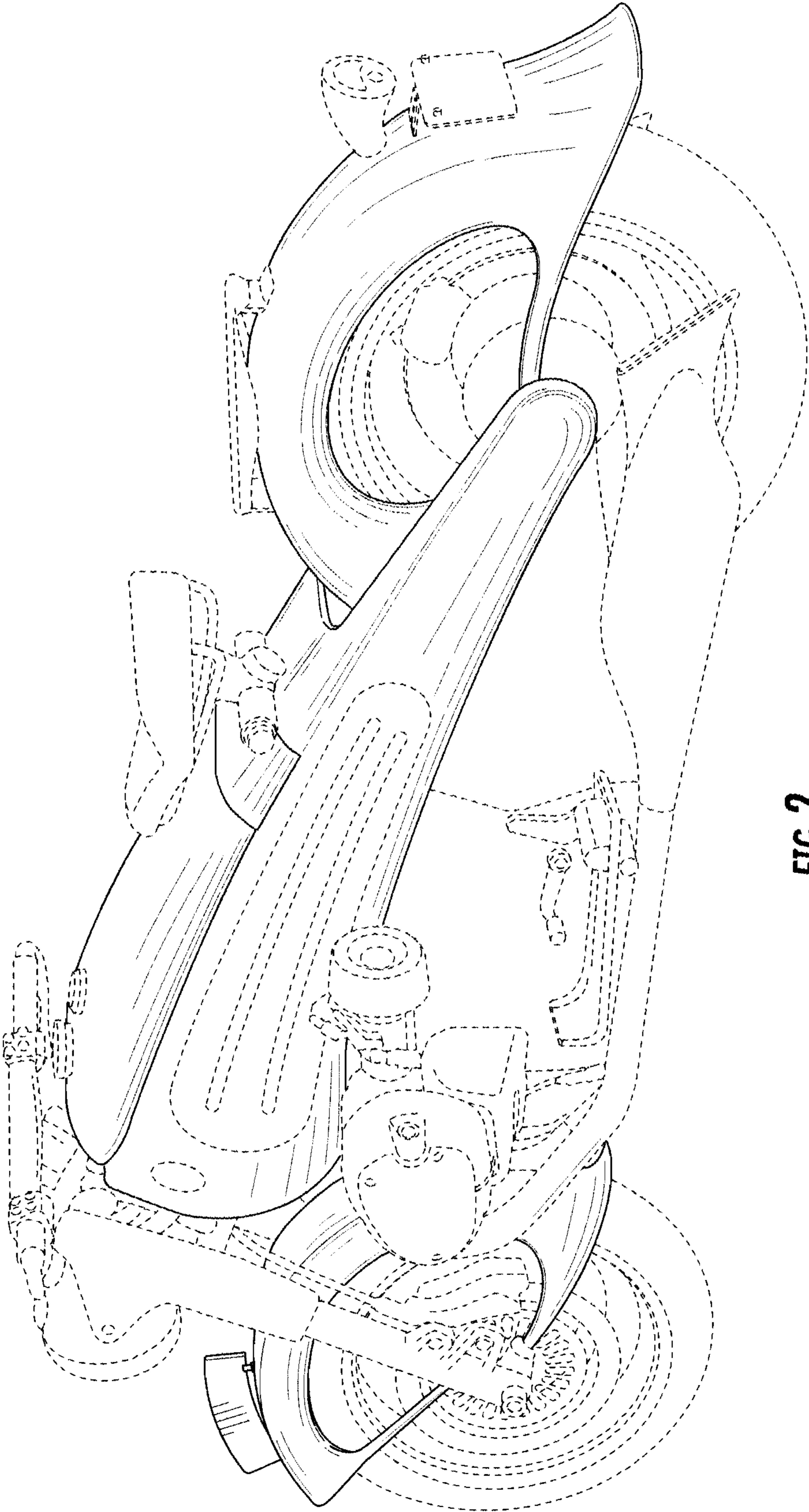

FIG. 2

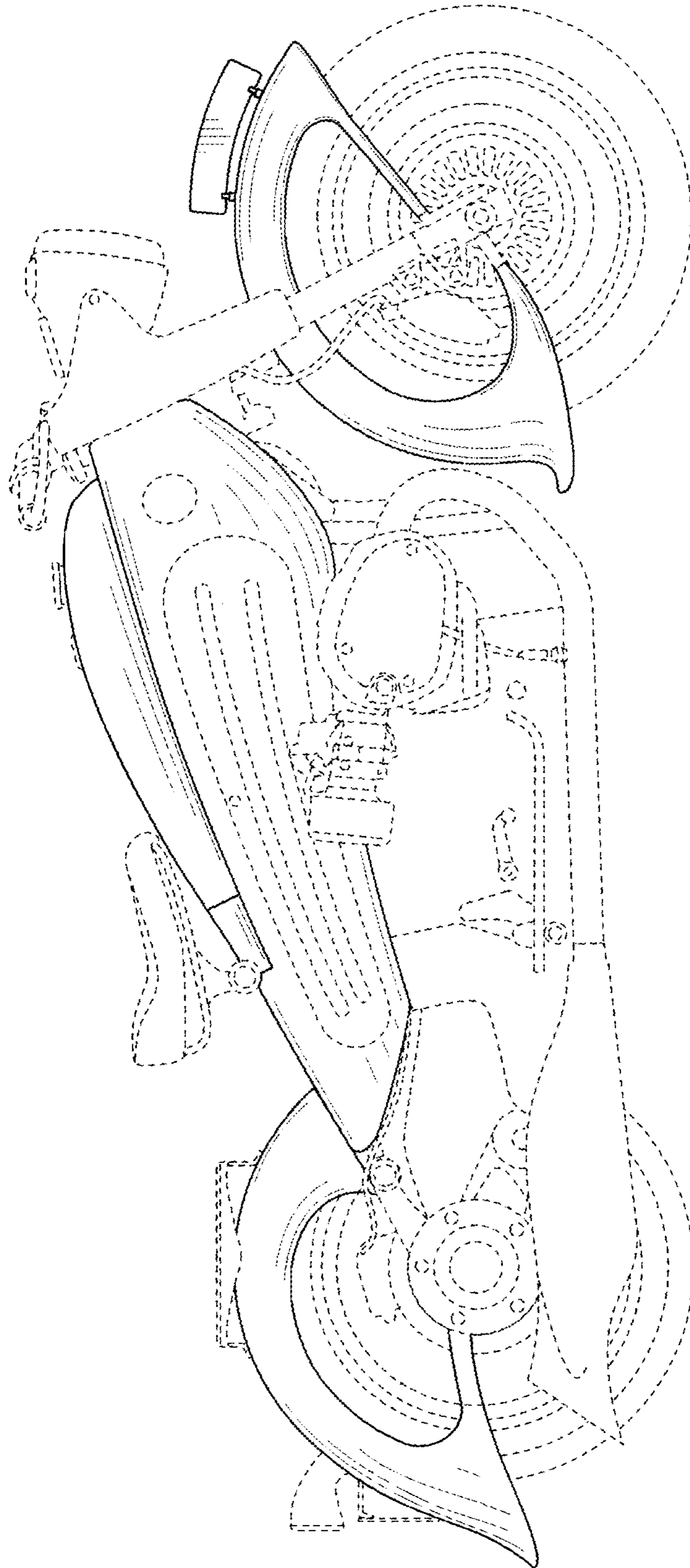

FIG. 3

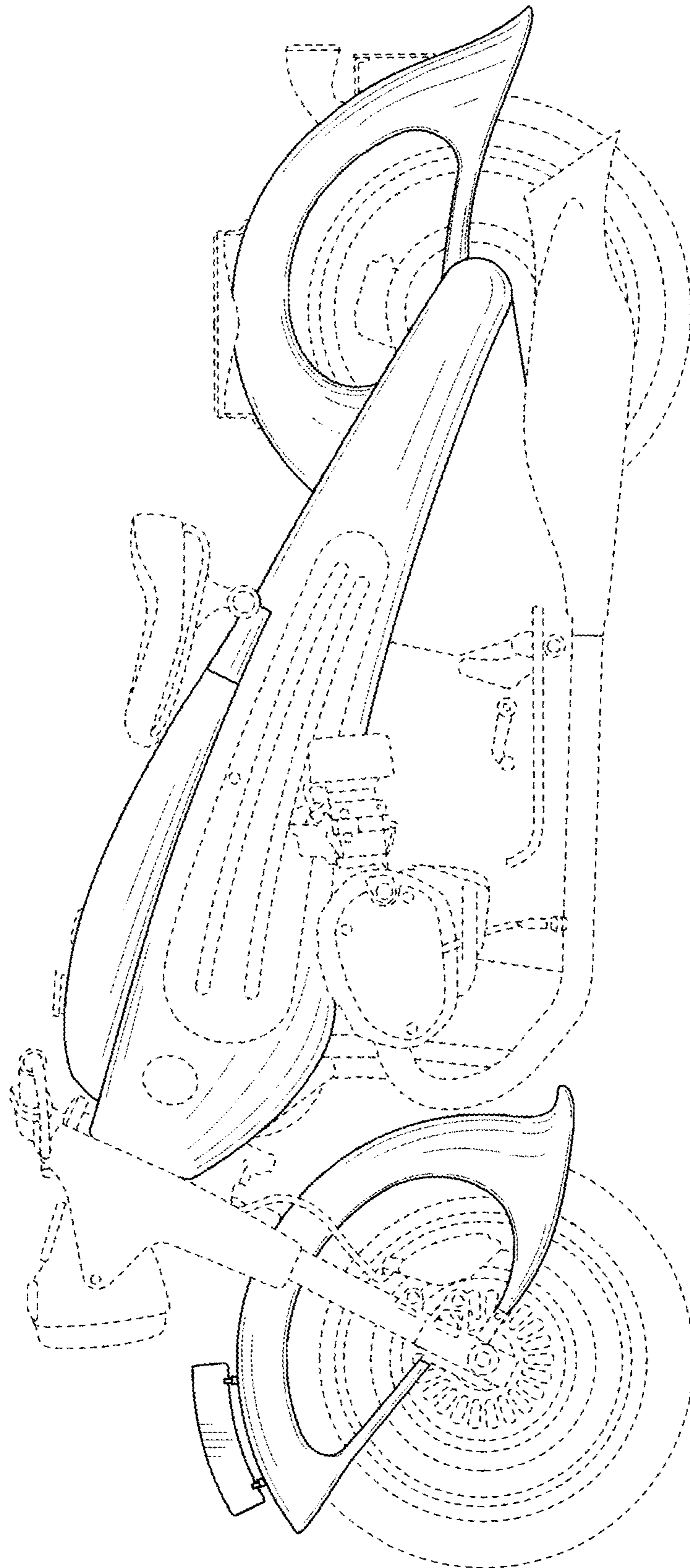

FIG. 4

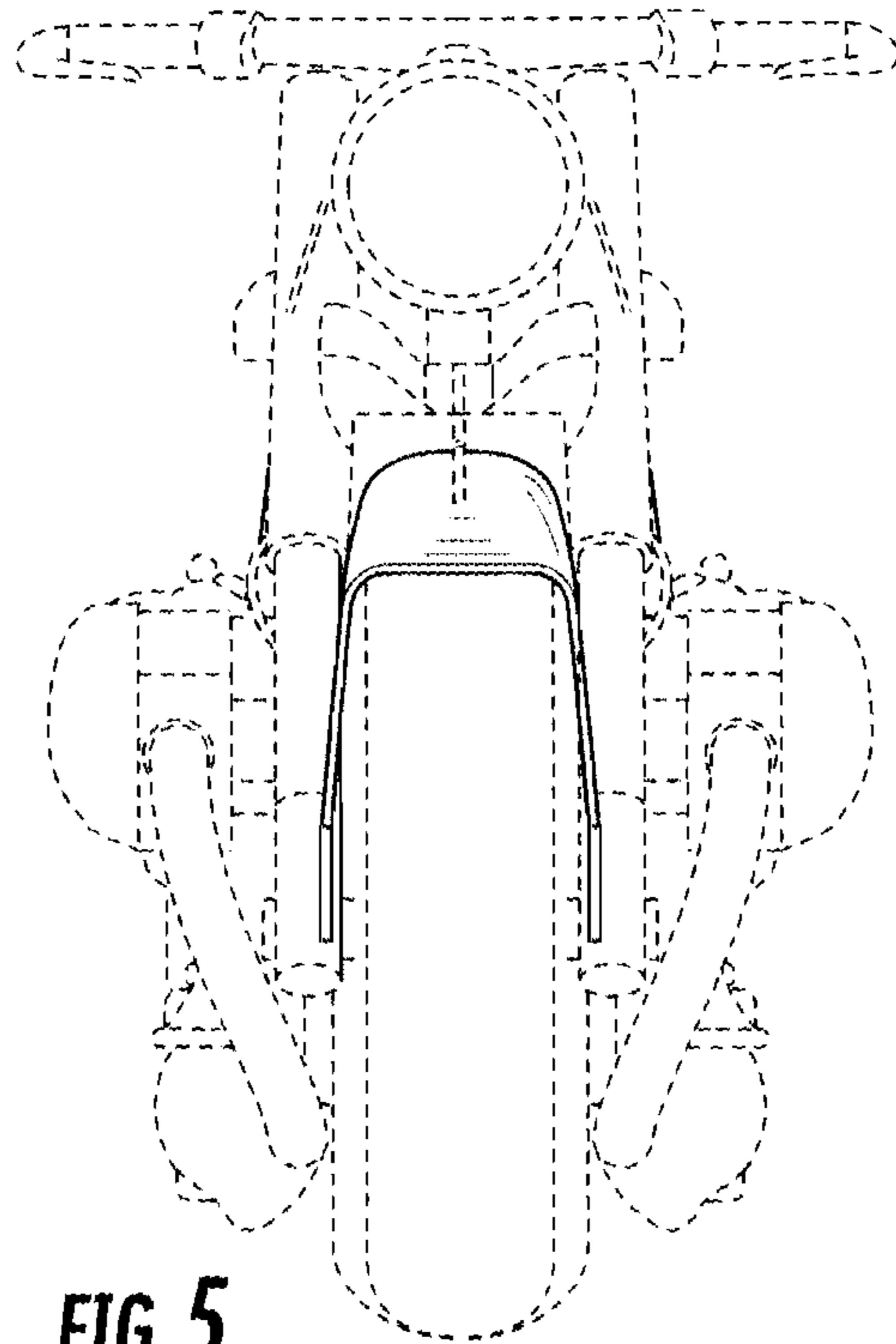

FIG. 5

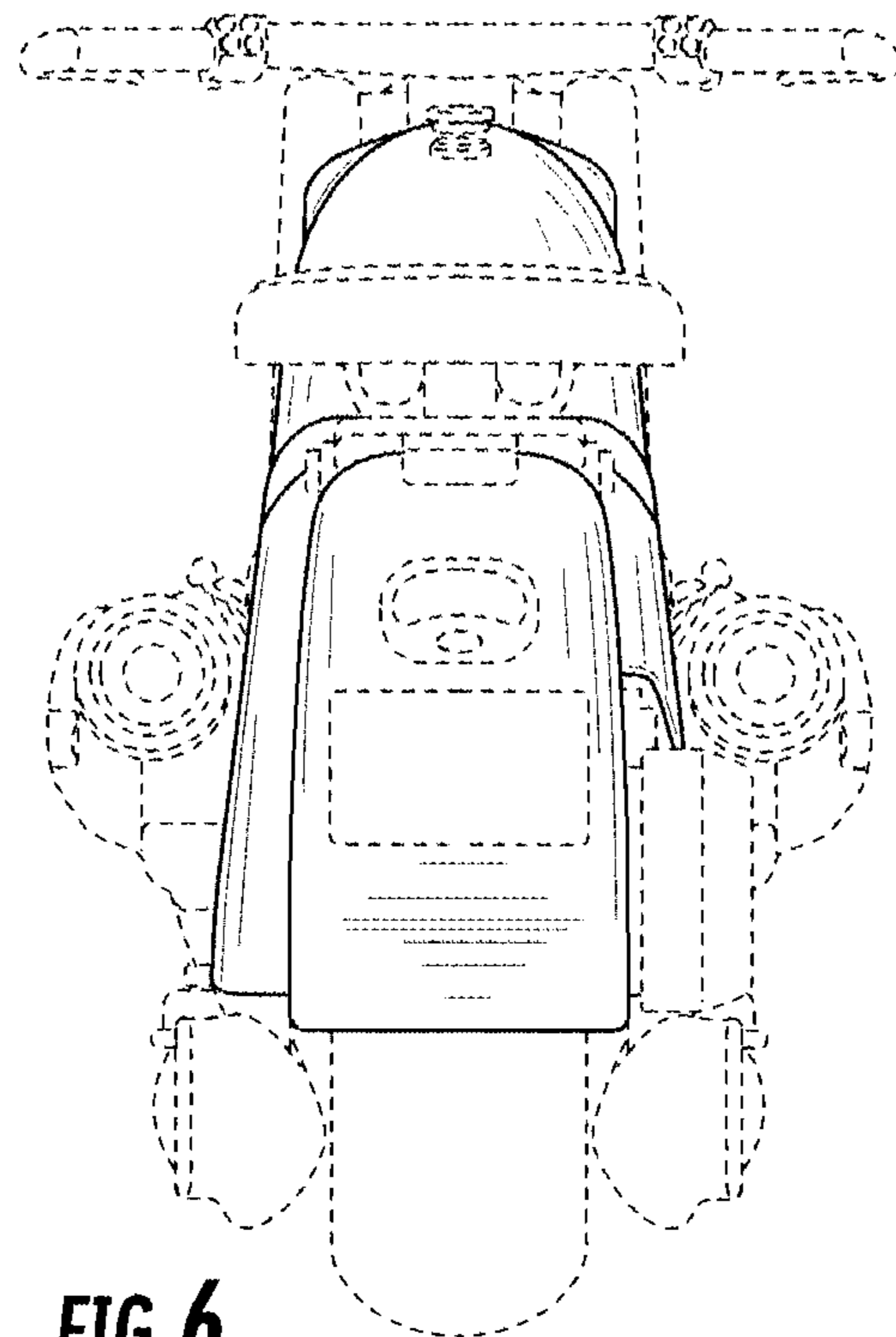

FIG. 6

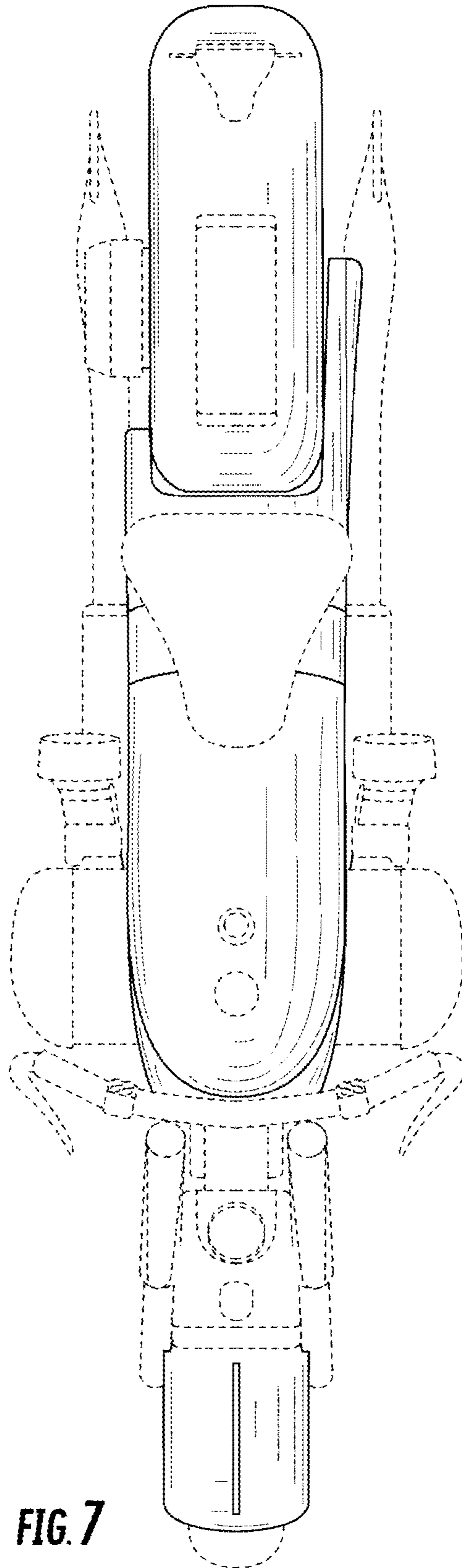

FIG. 7