



US00D921471S

(12) **United States Design Patent**  
**Lyytikäinen et al.**

(10) **Patent No.:** **US D921,471 S**

(45) **Date of Patent:** **\*\* Jun. 8, 2021**

(54) **GARDENING TOOL HANDLE**

(71) Applicant: **Fiskars Finland Oy Ab**, Helsinki (FI)

(72) Inventors: **Sami Lyytikäinen**, Helsinki (FI);  
**Mikko Kemppe**, Helsinki (FI)

(73) Assignee: **FISKARS FINLAND OY AB**, Helsinki (FI)

(\*\*) Term: **15 Years**

(21) Appl. No.: **29/653,701**

(22) Filed: **Jun. 18, 2018**

(30) **Foreign Application Priority Data**

Dec. 22, 2017 (EM) ..... 004561637

(51) **LOC (13) Cl.** ..... **08-05**

(52) **U.S. Cl.**  
USPC ..... **D8/107**

(58) **Field of Classification Search**

USPC ..... D8/1, 4, 5, 10, 13, 107  
CPC ... A01D 7/02; A01D 7/04; A01D 7/06; A01D 7/08; A01D 11/00; A01D 11/02; A01D 11/04; A01D 11/06; A01B 1/02; A01B 1/06; A01B 1/14; A01B 1/16; A01B 1/22  
See application file for complete search history.

(56) **References Cited**

**U.S. PATENT DOCUMENTS**

4,319,642 A \* 3/1982 Merz ..... A01B 1/16  
172/13  
D295,712 S \* 5/1988 Scott ..... D8/13  
D298,725 S \* 11/1988 Sunila ..... D8/13  
D305,496 S \* 1/1990 Jasperson ..... D8/10  
D305,497 S \* 1/1990 Jasperson ..... D8/13  
D339,039 S \* 9/1993 Concari ..... D8/13  
D342,426 S \* 12/1993 Concari ..... D8/10  
D354,661 S \* 1/1995 Linden ..... D8/10  
D360,343 S \* 7/1995 Concari ..... D8/10

D375,027 S \* 10/1996 Spear ..... D8/10  
D375,236 S \* 11/1996 Spear ..... D8/13  
D375,881 S \* 11/1996 Spear ..... D8/10  
D376,301 S \* 12/1996 Yates ..... D8/13  
D384,251 S \* 9/1997 Yeh ..... D8/10  
D388,670 S \* 1/1998 Yeh ..... D8/13  
D426,136 S \* 6/2000 Yu ..... D8/107  
D456,676 S \* 5/2002 Sunila ..... D8/13  
D501,765 S \* 2/2005 Tatic ..... D8/5  
D502,068 S \* 2/2005 Tatic ..... D8/5  
D541,119 S \* 4/2007 Jost ..... D8/13  
D563,742 S \* 3/2008 Baker ..... D8/13

(Continued)

*Primary Examiner* — Sandra Snapp

*Assistant Examiner* — Ieisha N Price

(74) *Attorney, Agent, or Firm* — Leason Ellis LLP

(57) **CLAIM**

We claim the ornamental design for gardening tool handle, as shown and described.

**DESCRIPTION**

FIG. 1 is a top perspective view of gardening tool handle according to our new design, showing a first embodiment of the claimed design;  
FIG. 2 is a front view thereof;  
FIG. 3 is a rear view thereof;  
FIG. 4 is a left side view thereof;  
FIG. 5 is a right side view thereof;  
FIG. 6 is a top view thereof;  
FIG. 7 is a bottom view thereof;  
FIG. 8 is a top perspective view of a second embodiment of the claimed design;  
FIG. 9 is a front view thereof;  
FIG. 10 is a rear view thereof;  
FIG. 11 is a left side view thereof;  
FIG. 12 is a right side view thereof;  
FIG. 13 is a top view thereof; and,  
FIG. 14 is a bottom view thereof.

**1 Claim, 12 Drawing Sheets**

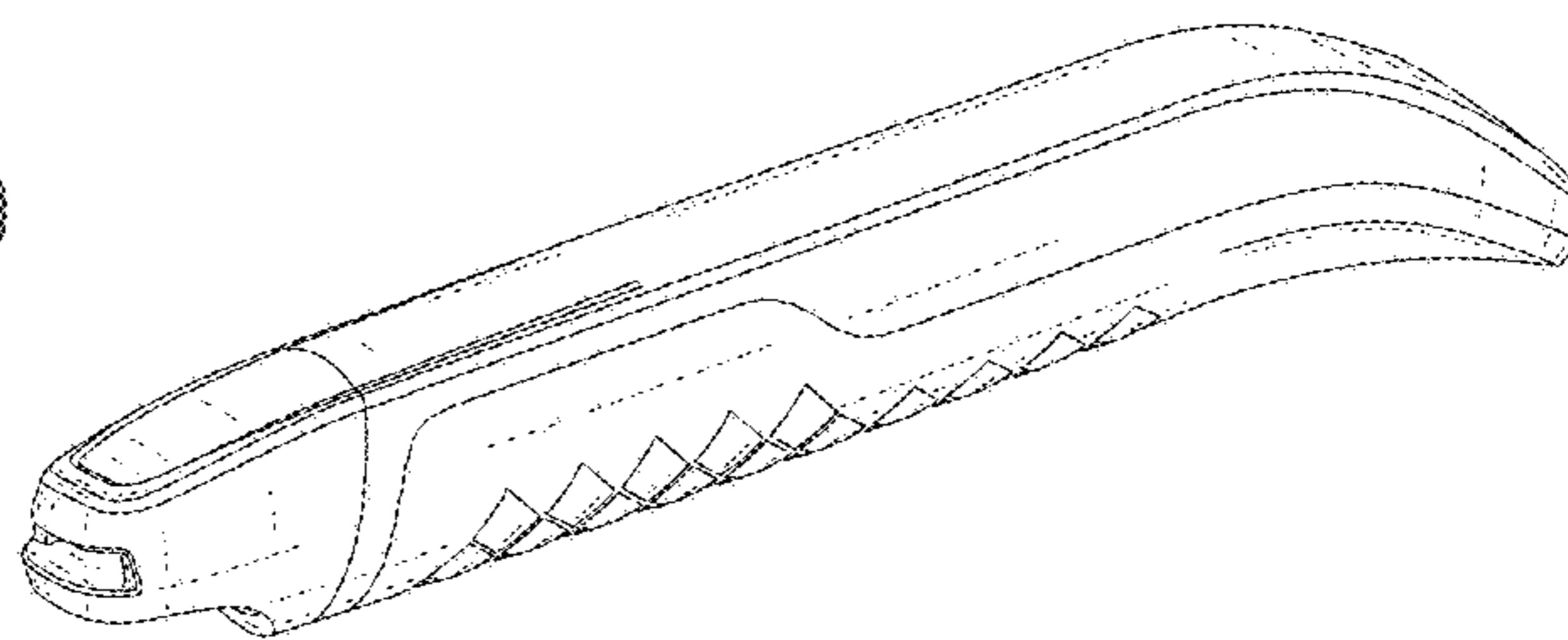
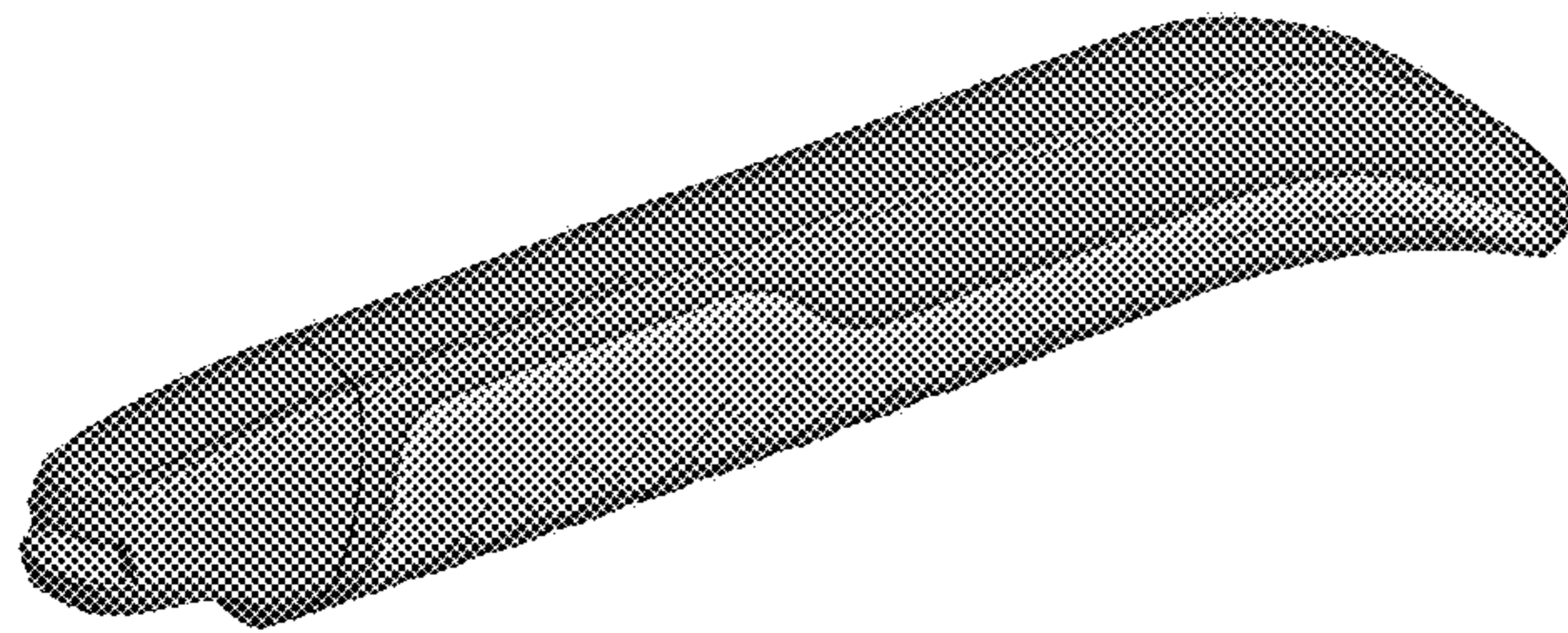

(56)

## References Cited

## U.S. PATENT DOCUMENTS

D600,984 S \* 9/2009 Wong ..... D8/10  
D604,126 S \* 11/2009 Boies ..... D8/1  
D611,316 S \* 3/2010 Boies ..... D8/1  
D625,571 S \* 10/2010 Frenkel ..... D8/13  
D640,103 S \* 6/2011 Paolini ..... D8/13  
D640,104 S \* 6/2011 Paolini ..... D8/13  
D642,440 S \* 8/2011 Boda ..... D8/13  
D653,091 S \* 1/2012 Hua ..... D8/10  
D670,150 S \* 11/2012 Angel ..... D8/107  
D675,075 S \* 1/2013 Paloheimo ..... D8/10  
D676,725 S \* 2/2013 Meiller ..... D8/10  
D678,013 S \* 3/2013 Hua ..... D8/13  
D678,014 S \* 3/2013 Hua ..... D8/13  
D678,738 S \* 3/2013 Hua ..... D8/13  
D684,441 S \* 6/2013 Baker ..... D8/10  
D691,434 S \* 10/2013 Nies ..... D8/5  
D691,435 S \* 10/2013 Nies ..... D8/5  
D703,511 S \* 4/2014 Bloch ..... D8/107  
D704,025 S \* 5/2014 Tronconi ..... B25G 1/04  
D8/107  
D710,665 S \* 8/2014 Boies ..... D8/10  
D711,204 S \* 8/2014 Masalin ..... D8/13  
D719,420 S \* 12/2014 Masalin ..... D8/13  
D725,447 S \* 3/2015 Gonzalez ..... D8/13  
D807,717 S \* 1/2018 Tia ..... D8/13  
D813,622 S \* 3/2018 Baker ..... D8/10  
D822,299 S \* 7/2018 Fair ..... D32/50  
D825,312 S \* 8/2018 Buckley ..... A47L 13/22  
D8/307  
D850,872 S \* 6/2019 Roberts ..... D8/13  
D859,102 S \* 9/2019 Roberts ..... D8/10  
D873,634 S \* 1/2020 Landreville ..... D8/10  
2015/0230400 A1 \* 8/2015 Tia ..... A01D 7/00  
56/400.01  
2019/0045696 A1 \* 2/2019 Schoeppner ..... A01B 1/20

\* cited by examiner



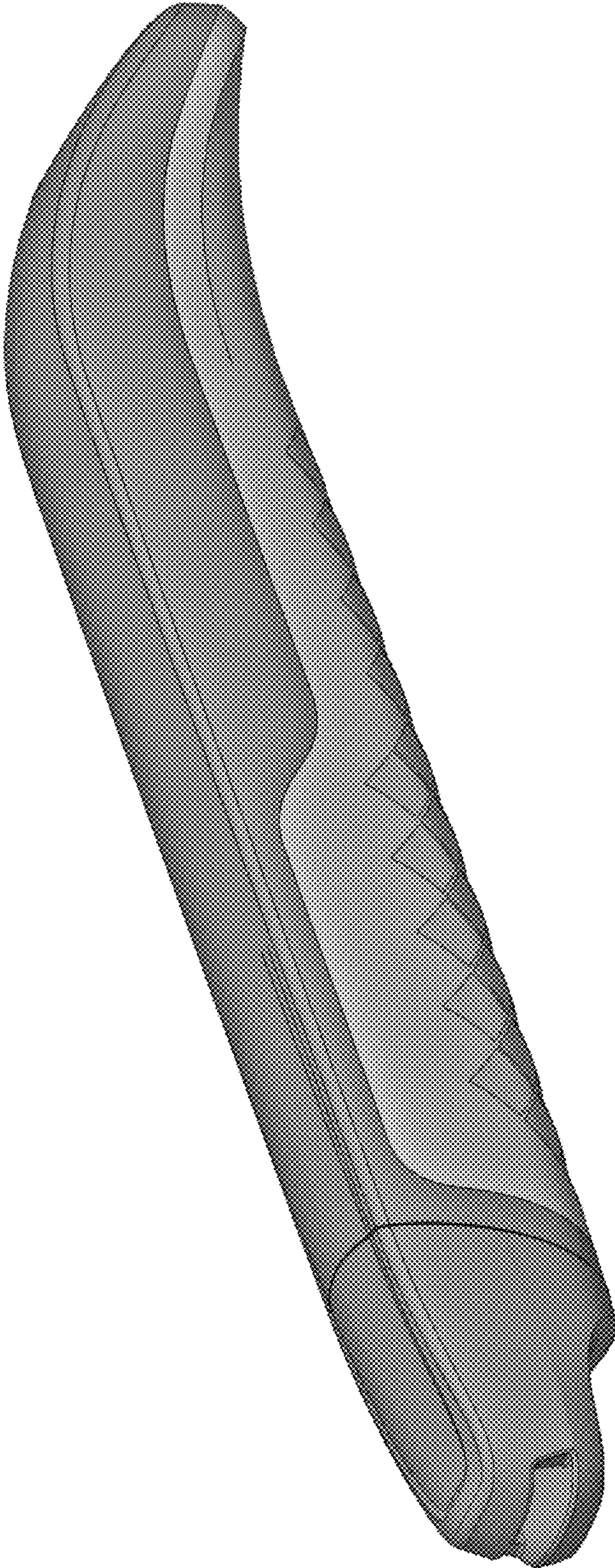

FIG. 1

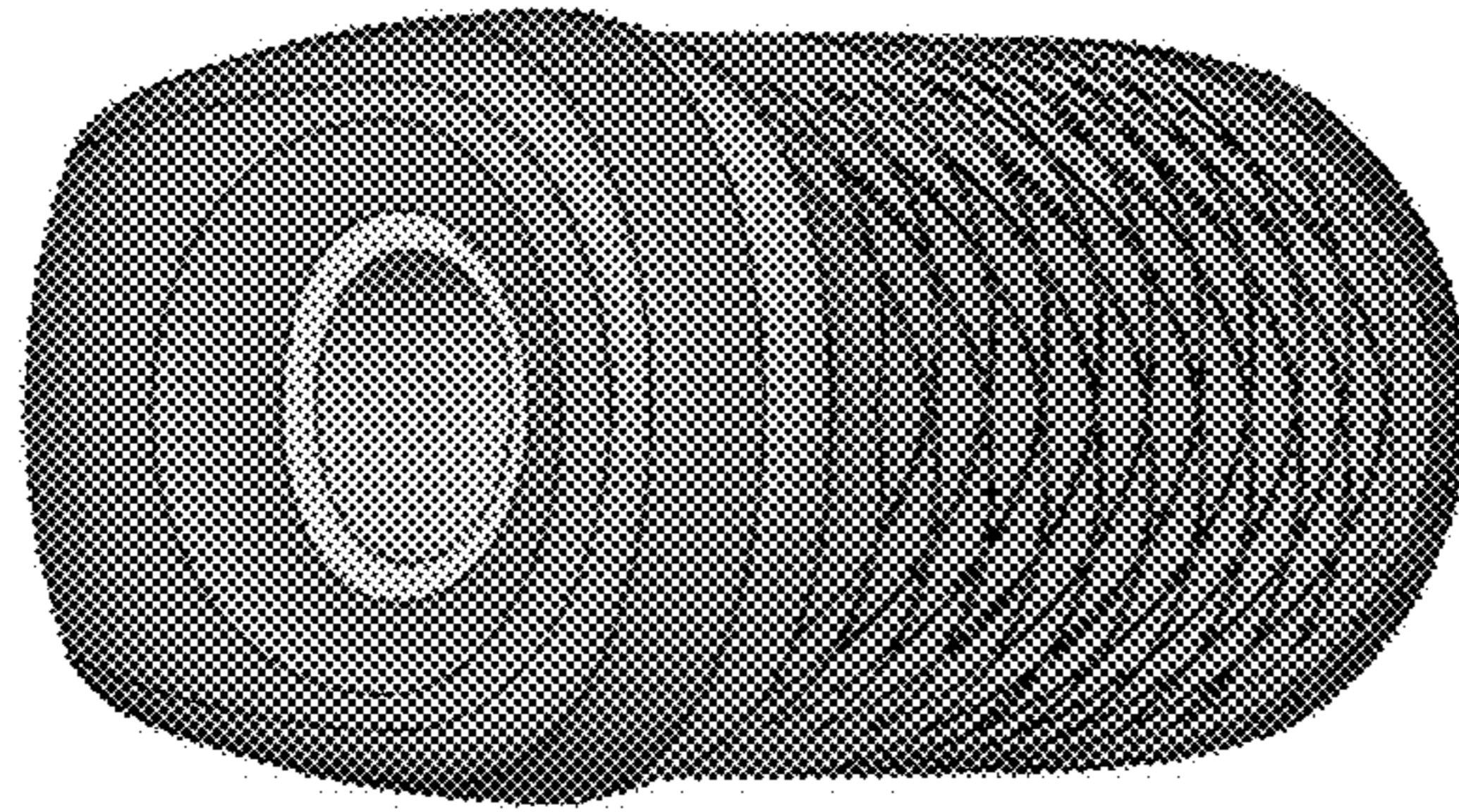

FIG. 3

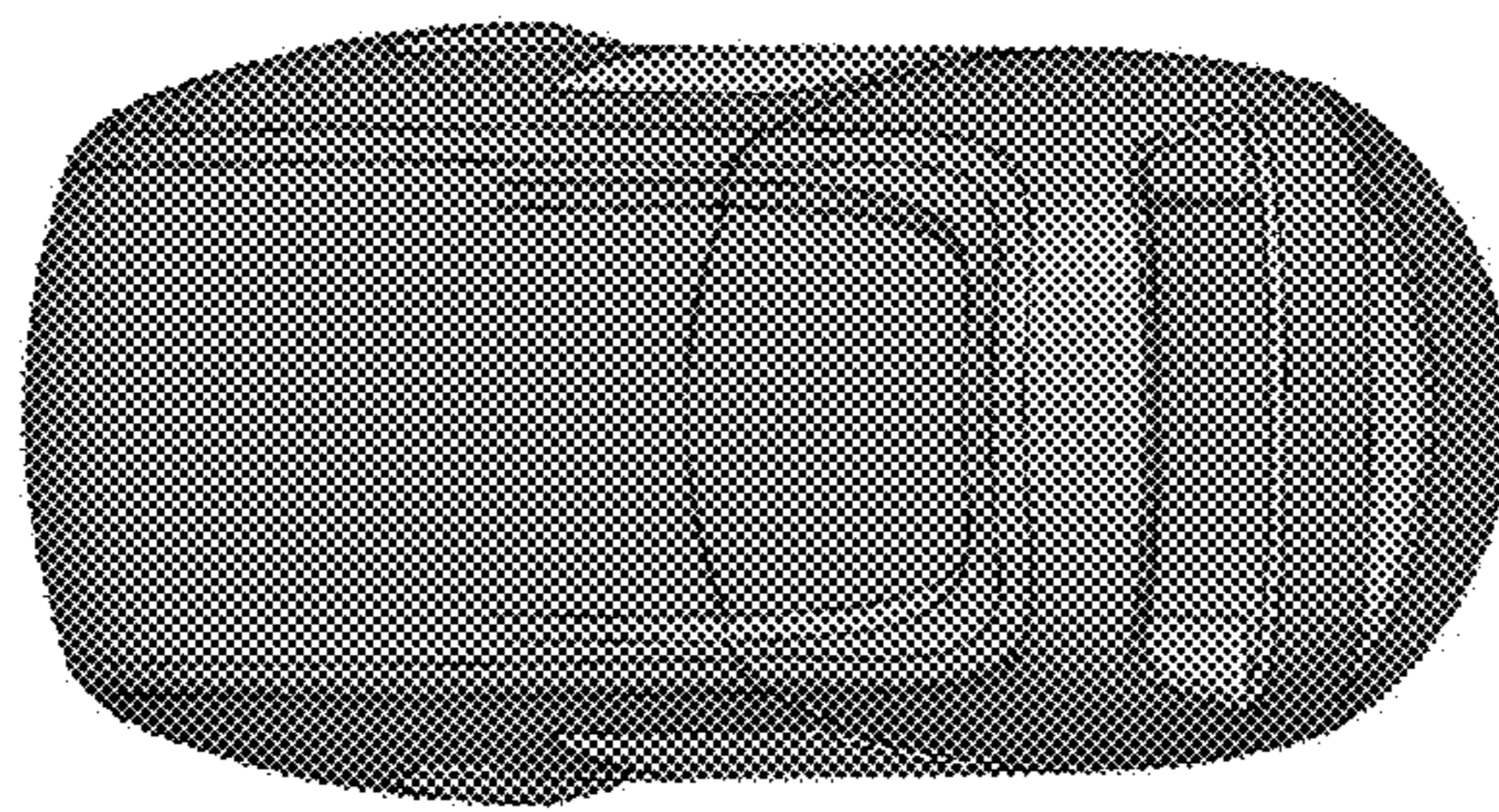

FIG. 2



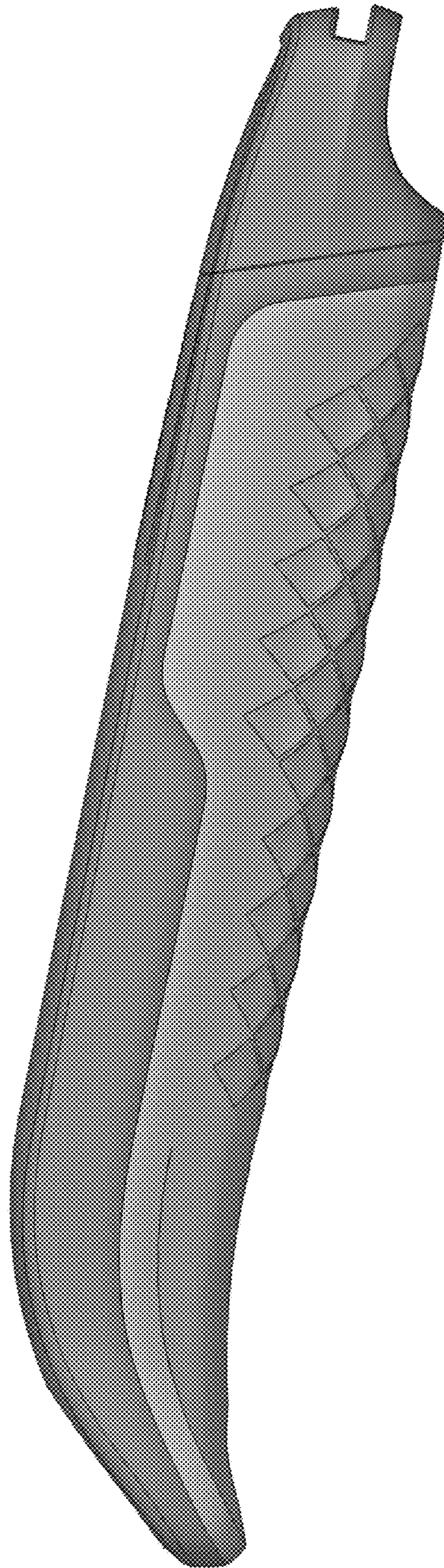

FIG. 4



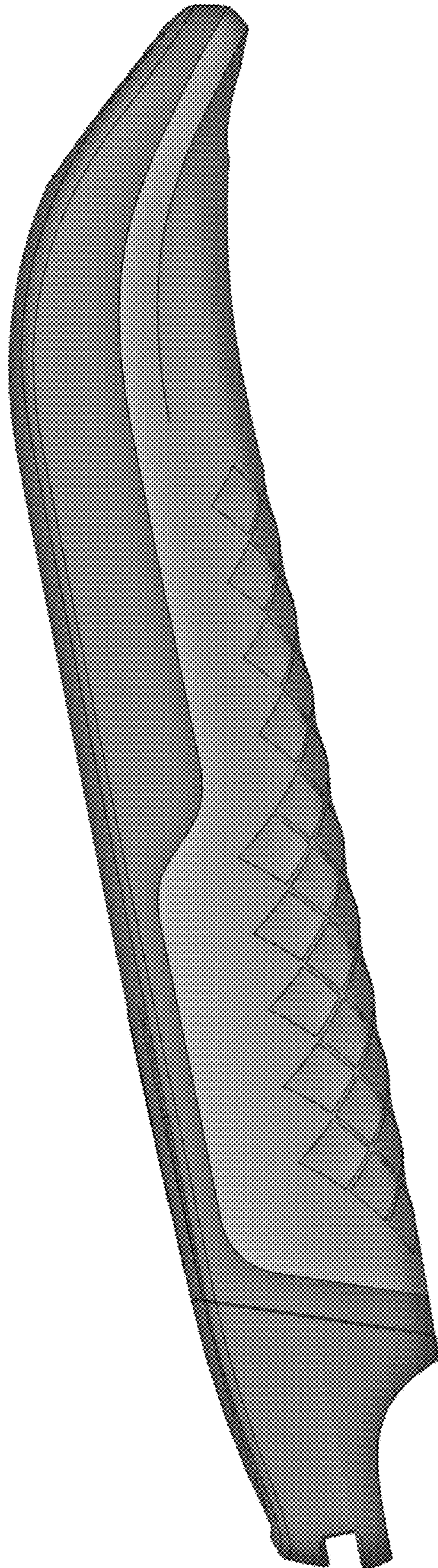

FIG. 5



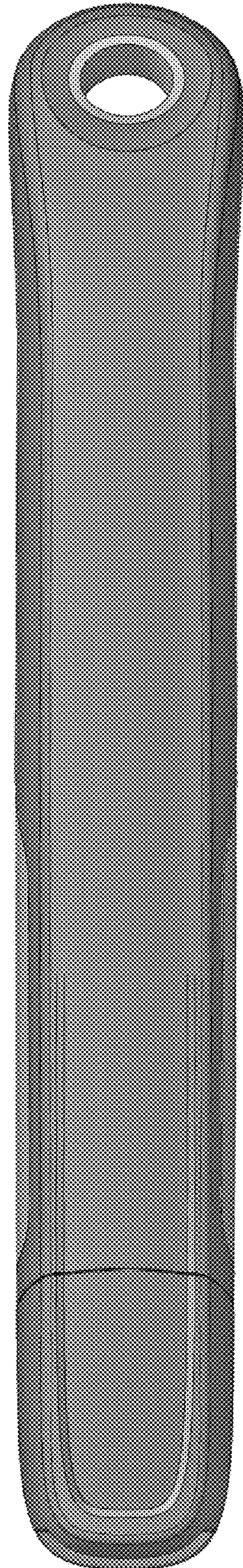

FIG. 6



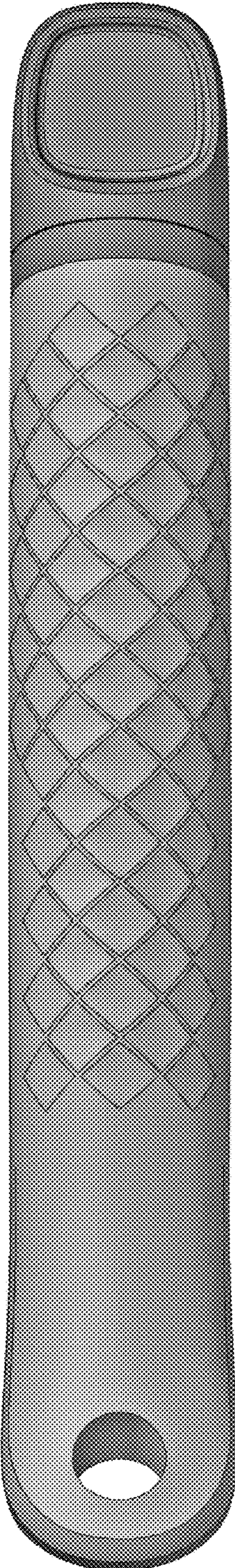

FIG. 7



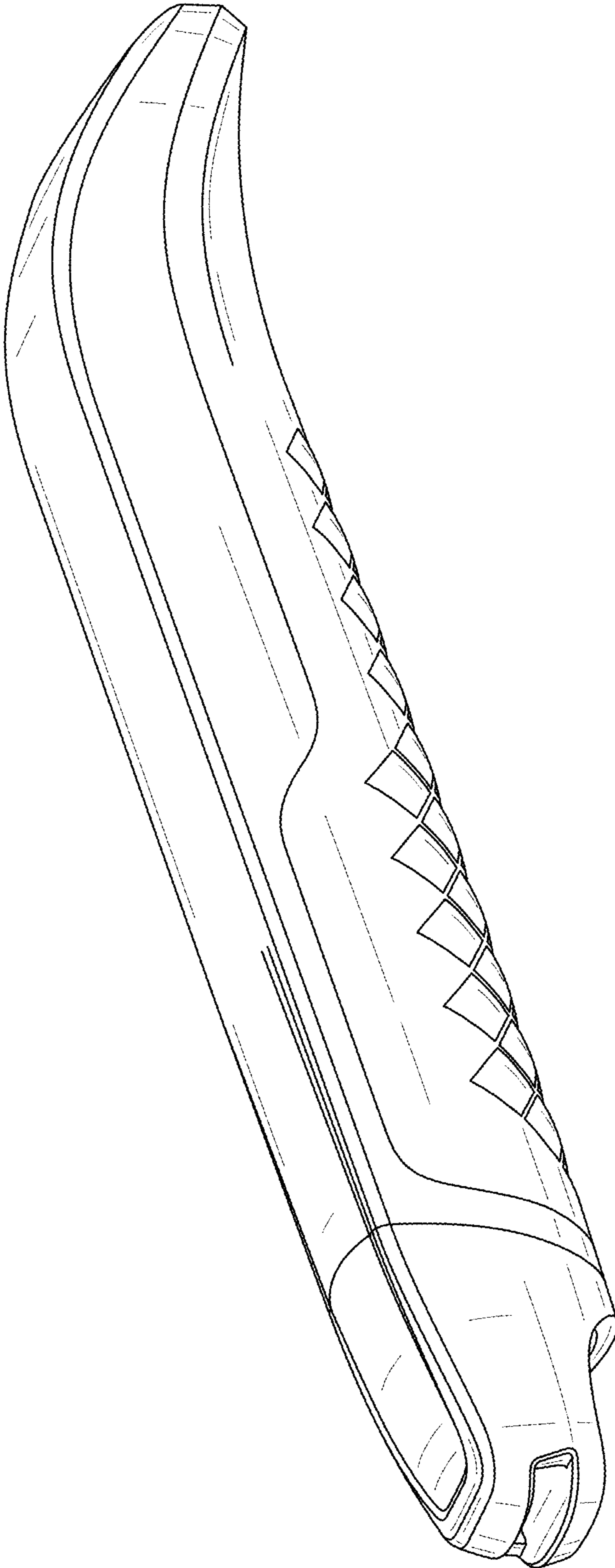

FIG. 8

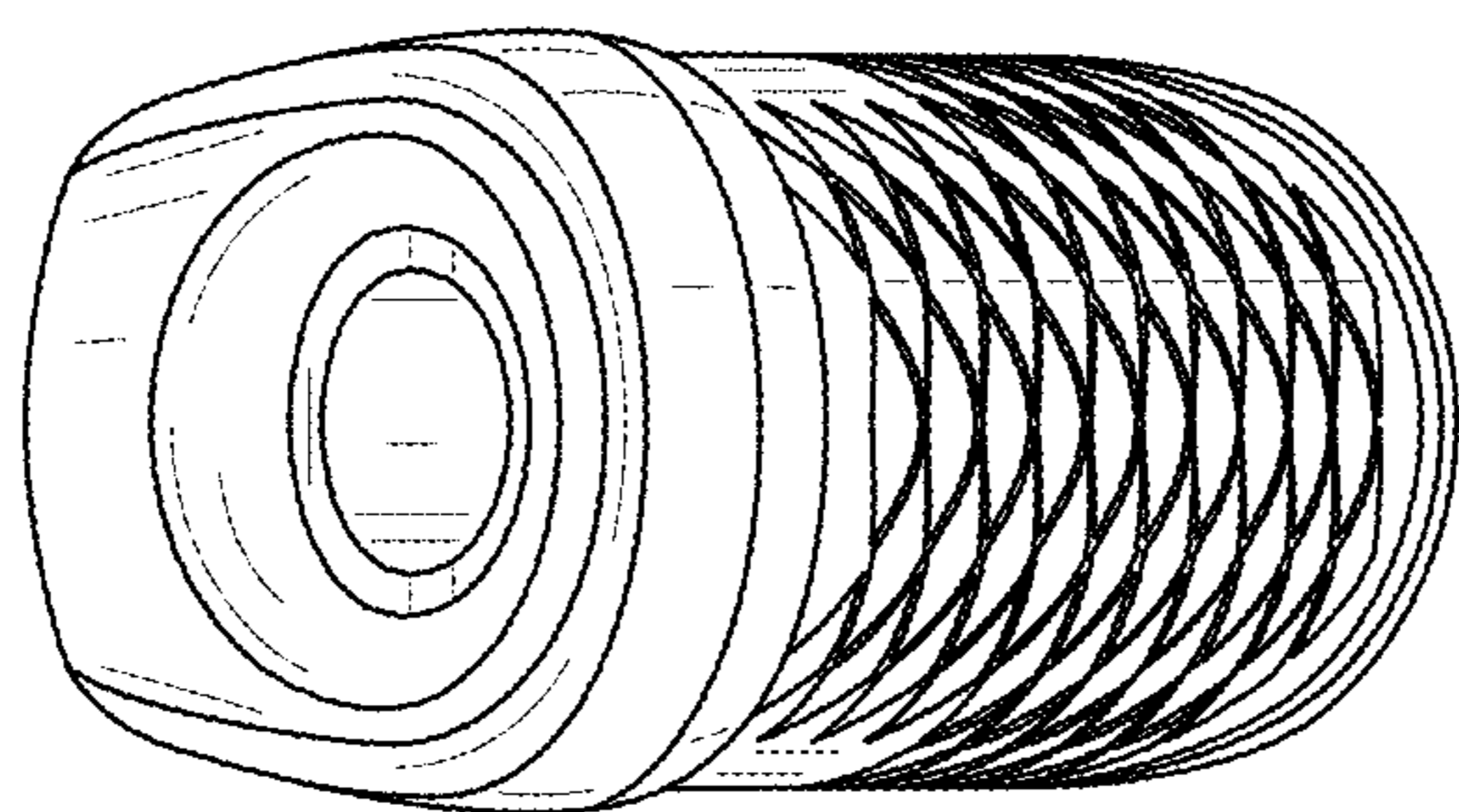

FIG. 9

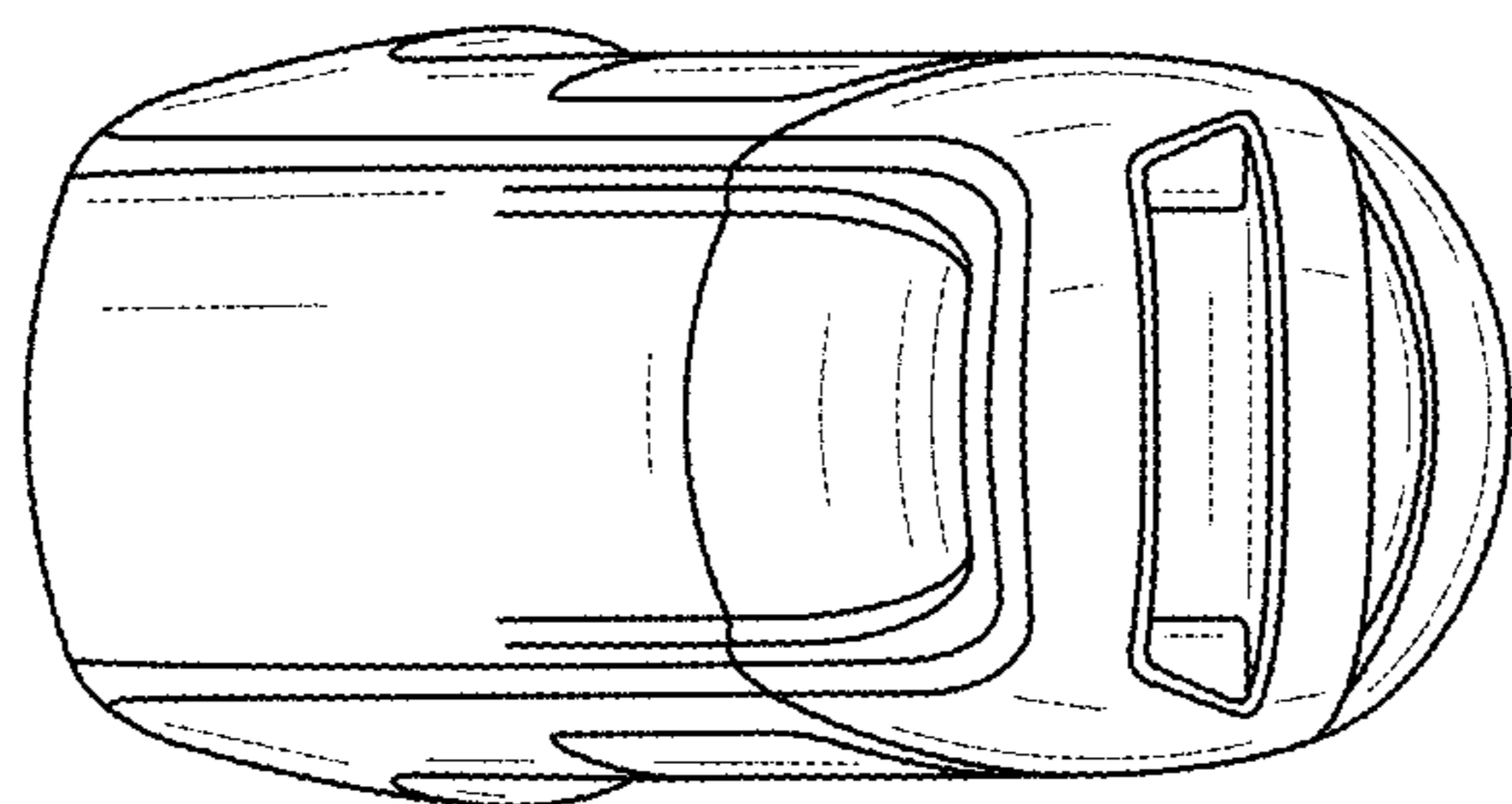

FIG. 10



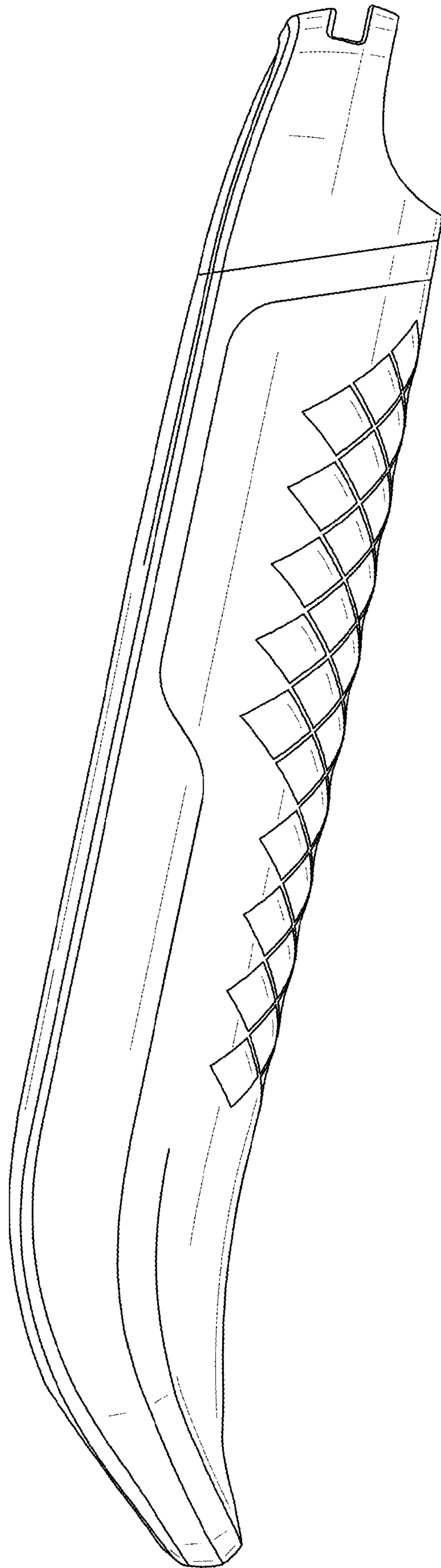

FIG. 11

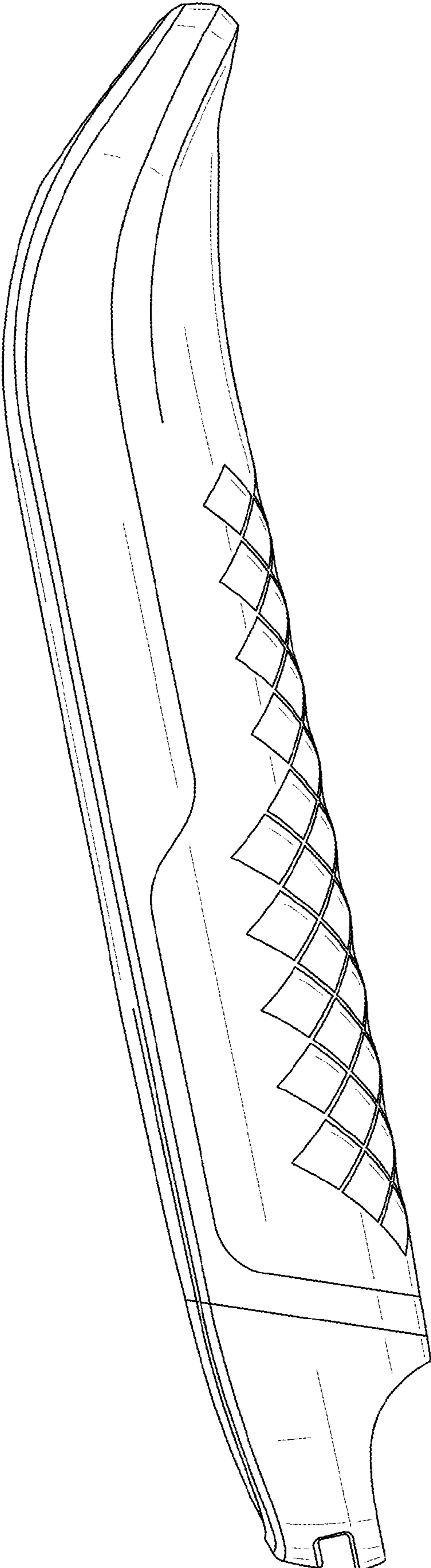

FIG. 12



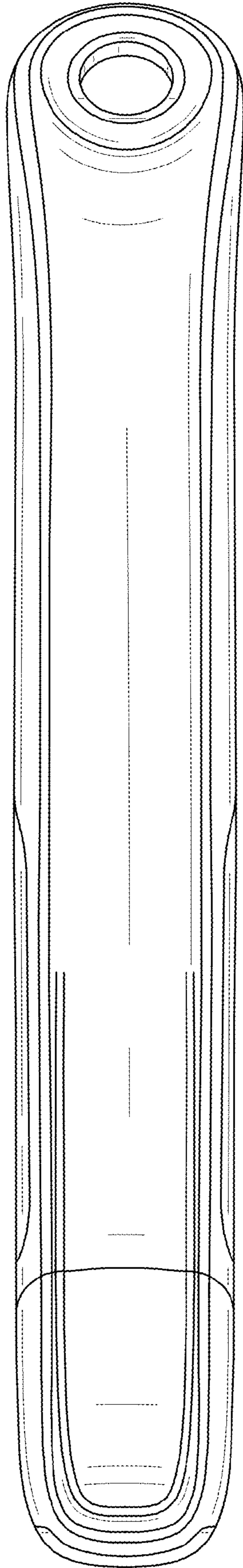

FIG. 13

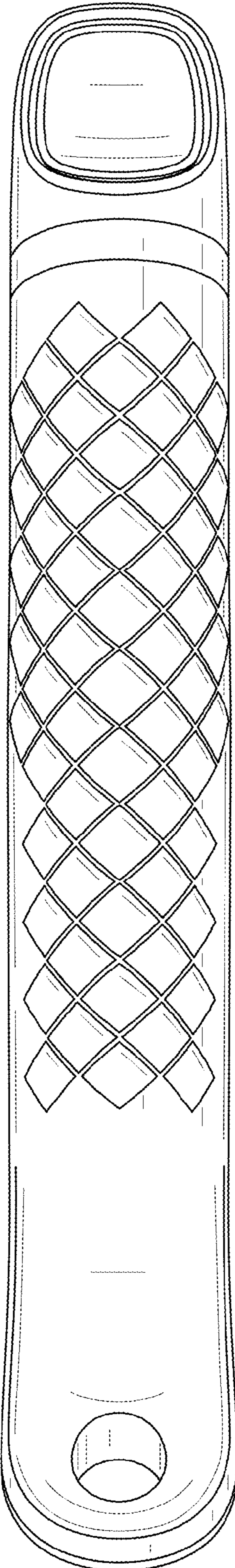

FIG. 14