



US00D921441S

(12) **United States Design Patent**
Shook et al.

(10) **Patent No.:** **US D921,441 S**

(45) **Date of Patent:** **** Jun. 8, 2021**

(54) **BEVERAGE CAN CAPSULE**

(71) Applicants: **Justin R. Shook**, Boise, ID (US);
Jacob D. Bottari, Boise, ID (US)

(72) Inventors: **Justin R. Shook**, Boise, ID (US);
Jacob D. Bottari, Boise, ID (US)

(**) Term: **15 Years**

(21) Appl. No.: **29/693,549**

(22) Filed: **Jun. 3, 2019**

(51) **LOC (13) Cl.** **07-07**

(52) **U.S. Cl.**

USPC **D7/608; D7/607**

(58) **Field of Classification Search**

USPC D7/500, 584, 590, 600.1, 600.2, 602,
D7/600.4, 601, 605, 607, 608, 619.1, 620,
D7/622, 624.1, 624.2, 624.3, 701, 704;
D3/306; D6/574, 571, 705, 677.1
CPC . A47F 5/01; A47F 5/02; A47F 7/0064; A47G
23/0216; A47G 23/0225; A47G 23/03;
A47G 19/02; A47G 19/025; A45C 11/20;
B65D 1/24; B65D 1/36

See application file for complete search history.

(56) **References Cited**

U.S. PATENT DOCUMENTS

4,462,444 A * 7/1984 Larson B65D 81/3886
215/12.1
D441,614 S * 5/2001 Carroll D7/608

D493,674 S * 8/2004 Lowe D7/606
D498,392 S * 11/2004 Lowe D12/500
D546,631 S * 7/2007 Carey D7/625
D557,994 S * 12/2007 Wahl D7/608
D673,459 S * 1/2013 Moran, Sr. D7/608
D685,229 S * 7/2013 Moran, Sr. D7/608
D708,914 S * 7/2014 Moran, Sr. D7/608
D826,649 S * 8/2018 Hooker D7/607
D828,113 S * 9/2018 Fleischhut D7/608

* cited by examiner

Primary Examiner — Karen S Acker

Assistant Examiner — Steven B Reinholdt, Jr.

(57) **CLAIM**

The ornamental design for a beverage can capsule, as shown and described.

DESCRIPTION

FIG. 1 is a perspective view of a beverage can capsule, showing our new design.

FIG. 2 is a front view thereof.

FIG. 3 is a rear view thereof.

FIG. 4 is a right side view thereof.

FIG. 5 is a left side view thereof.

FIG. 6 is a top view thereof.

FIG. 7 is a bottom view thereof; and,

FIG. 8 is an exploded perspective view thereof.

The broken lines and the areas within them depict portions of the beverage can capsule that form no part of the claimed design.

1 Claim, 8 Drawing Sheets

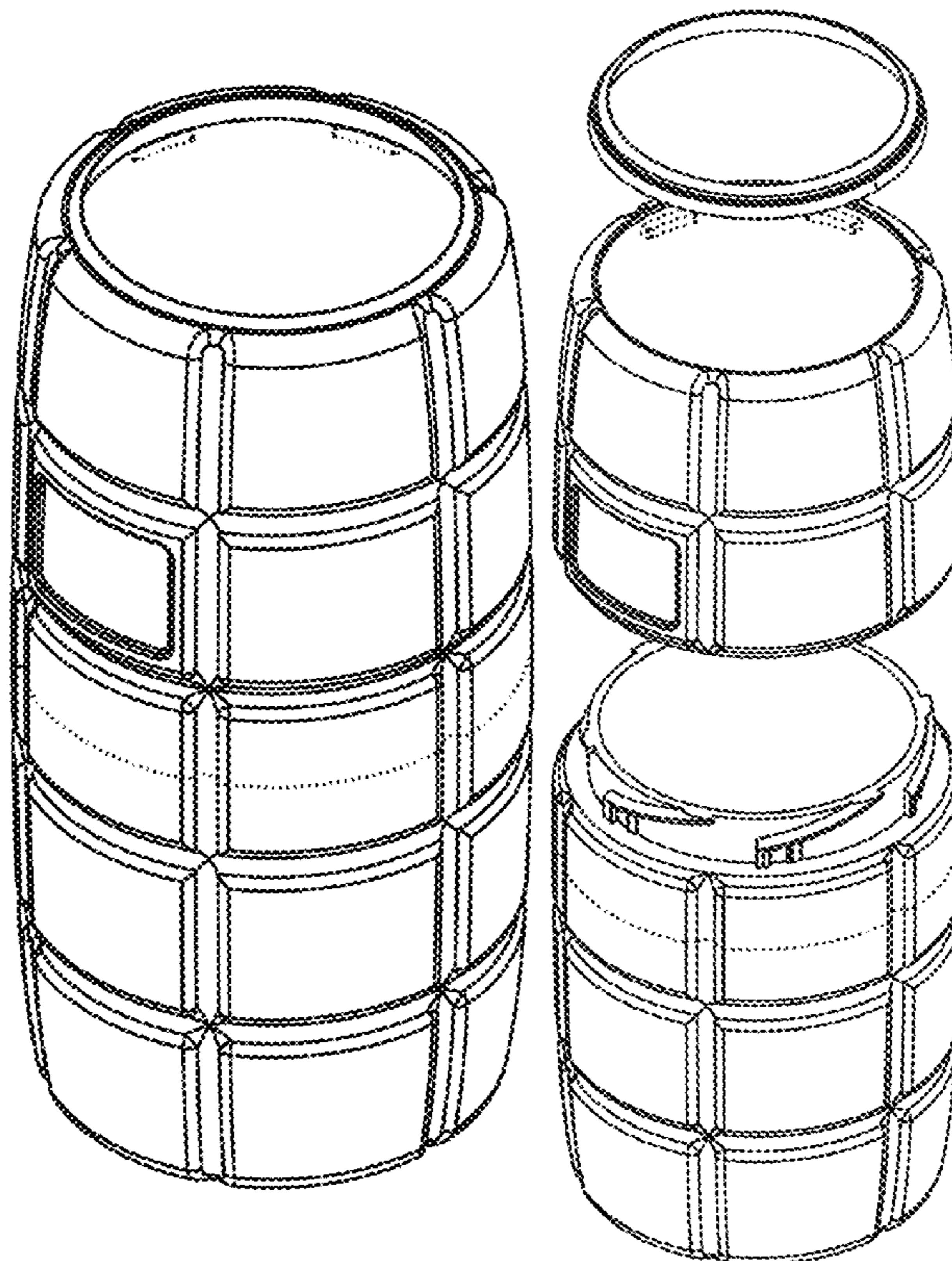

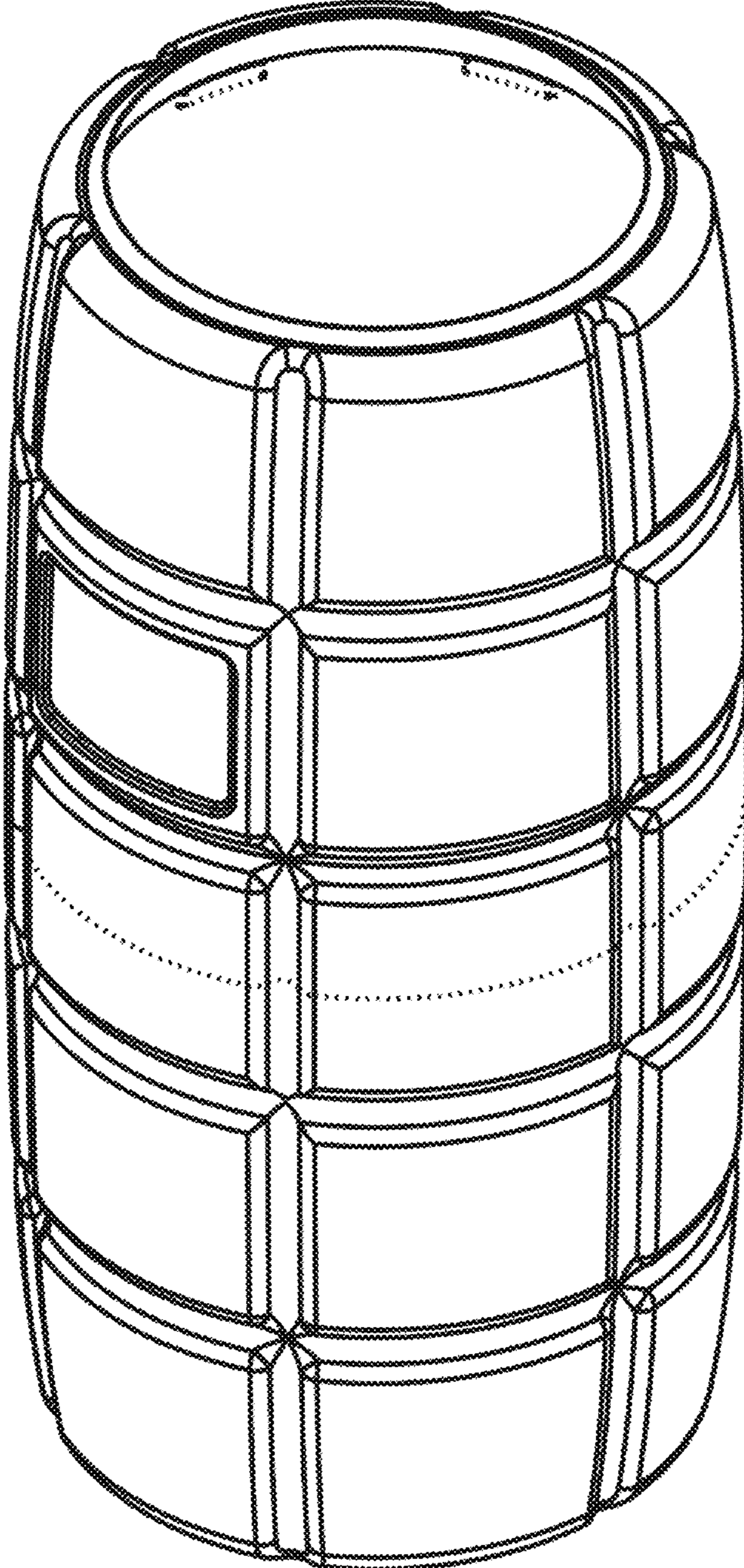

FIG. 1

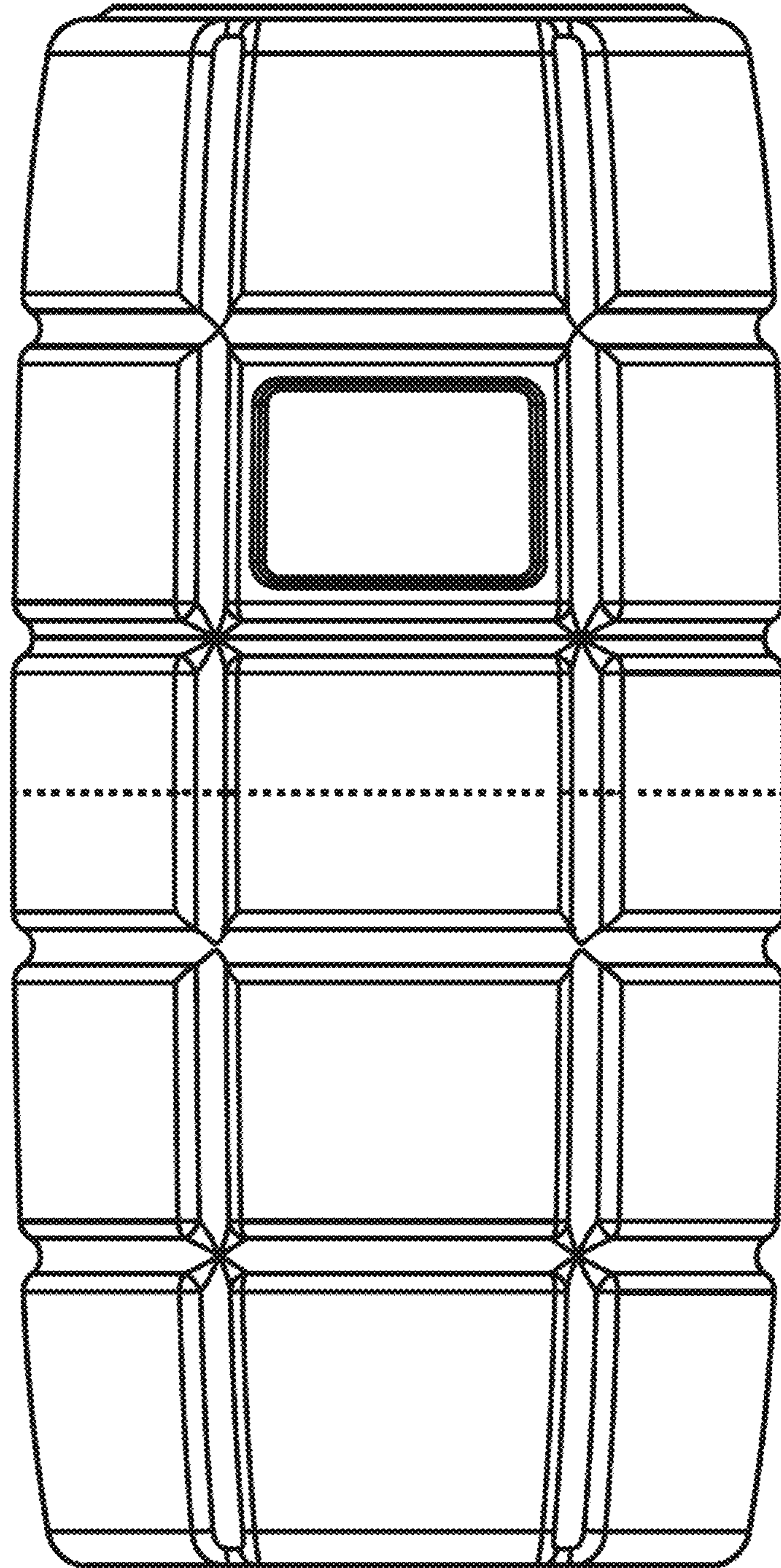

FIG. 2

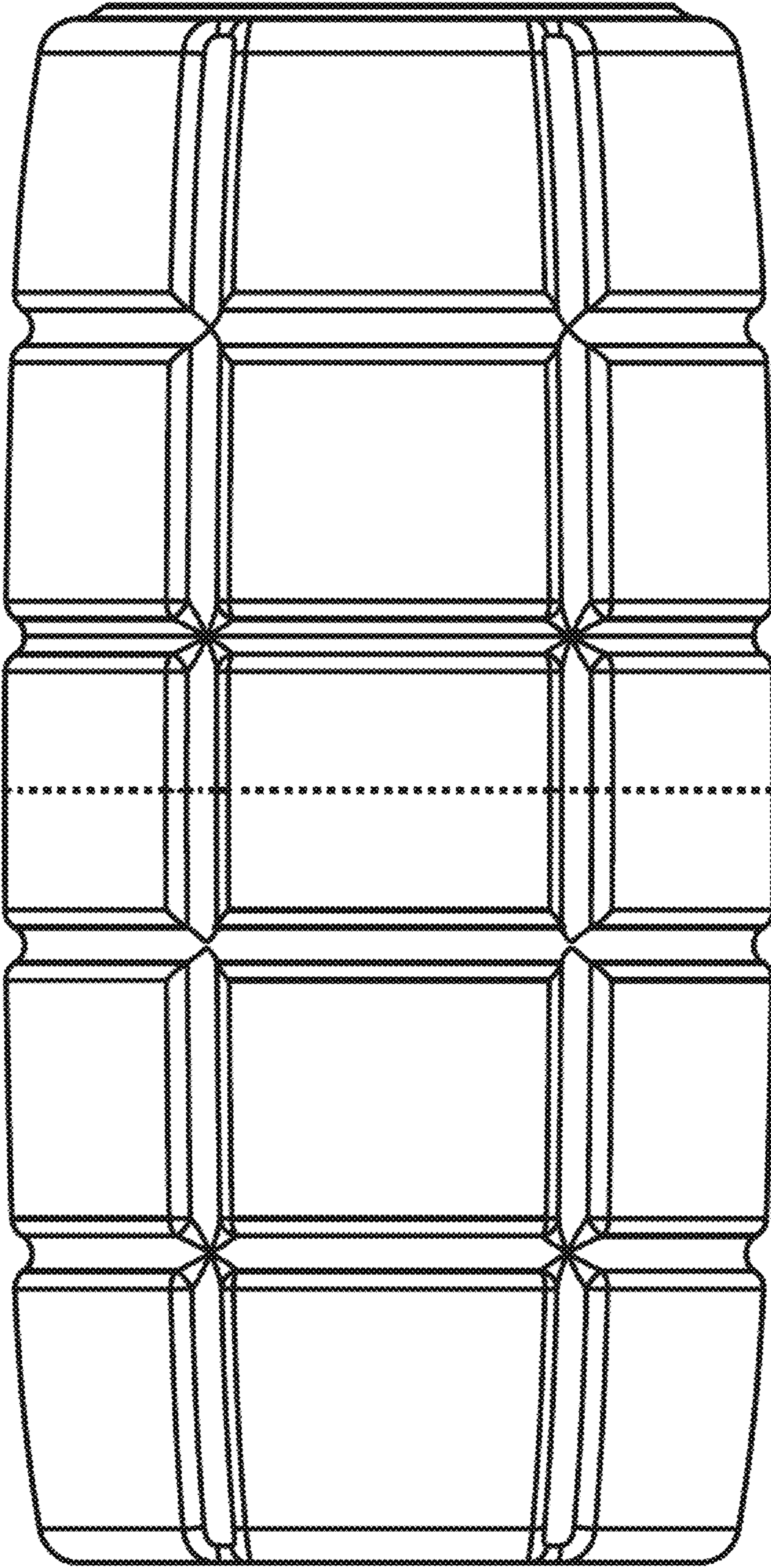

FIG. 3

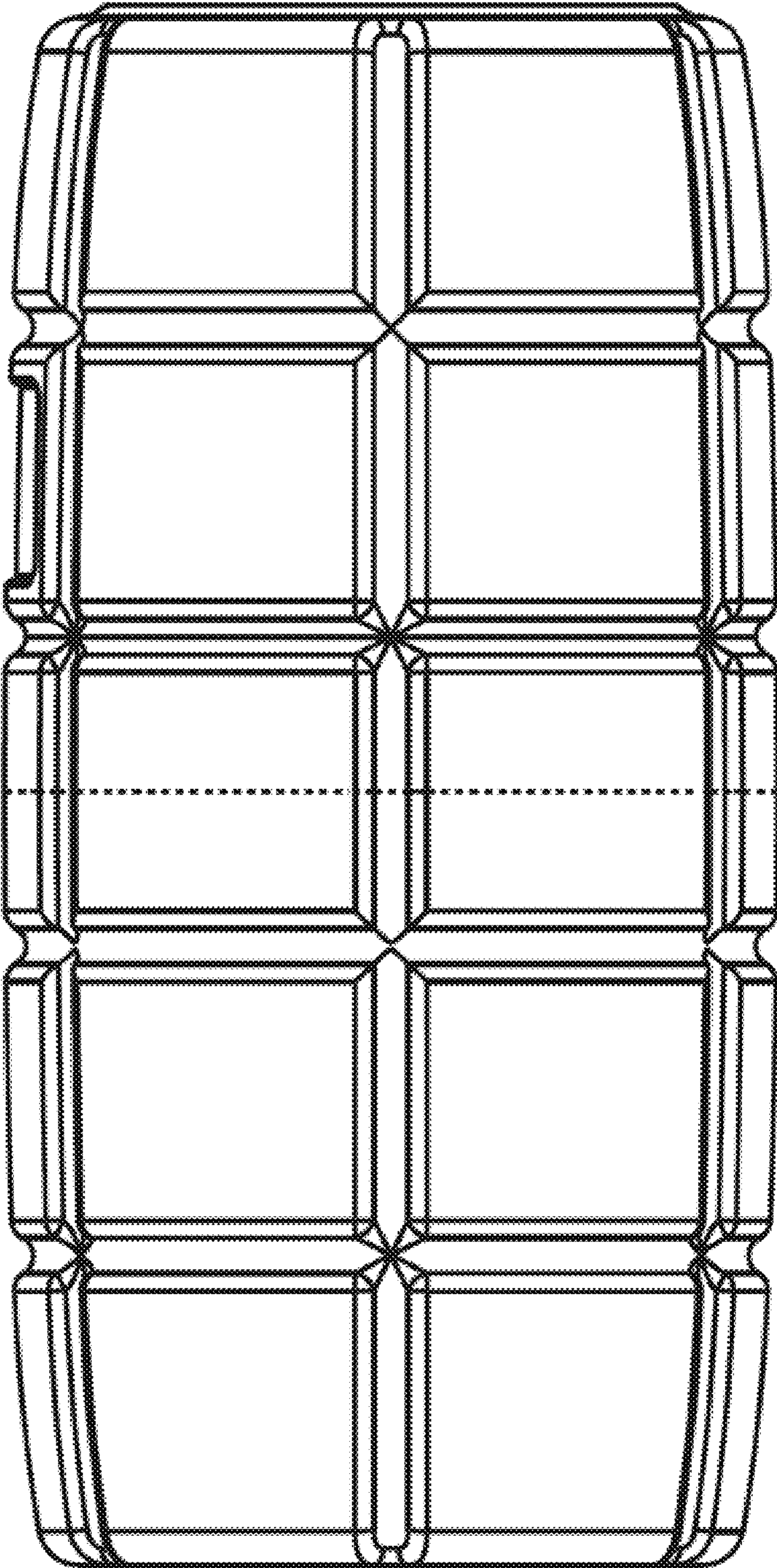

FIG. 4

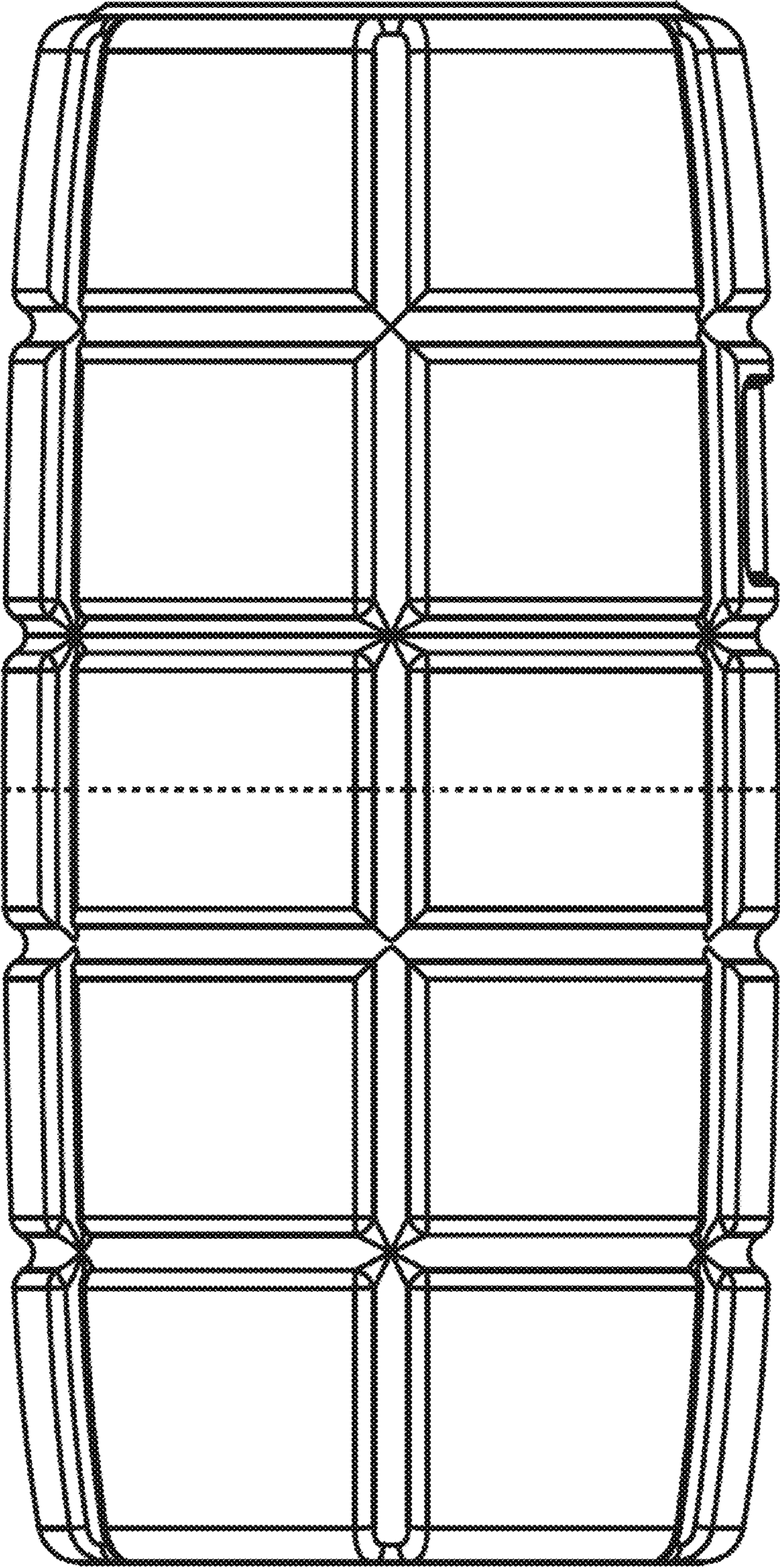

FIG. 5

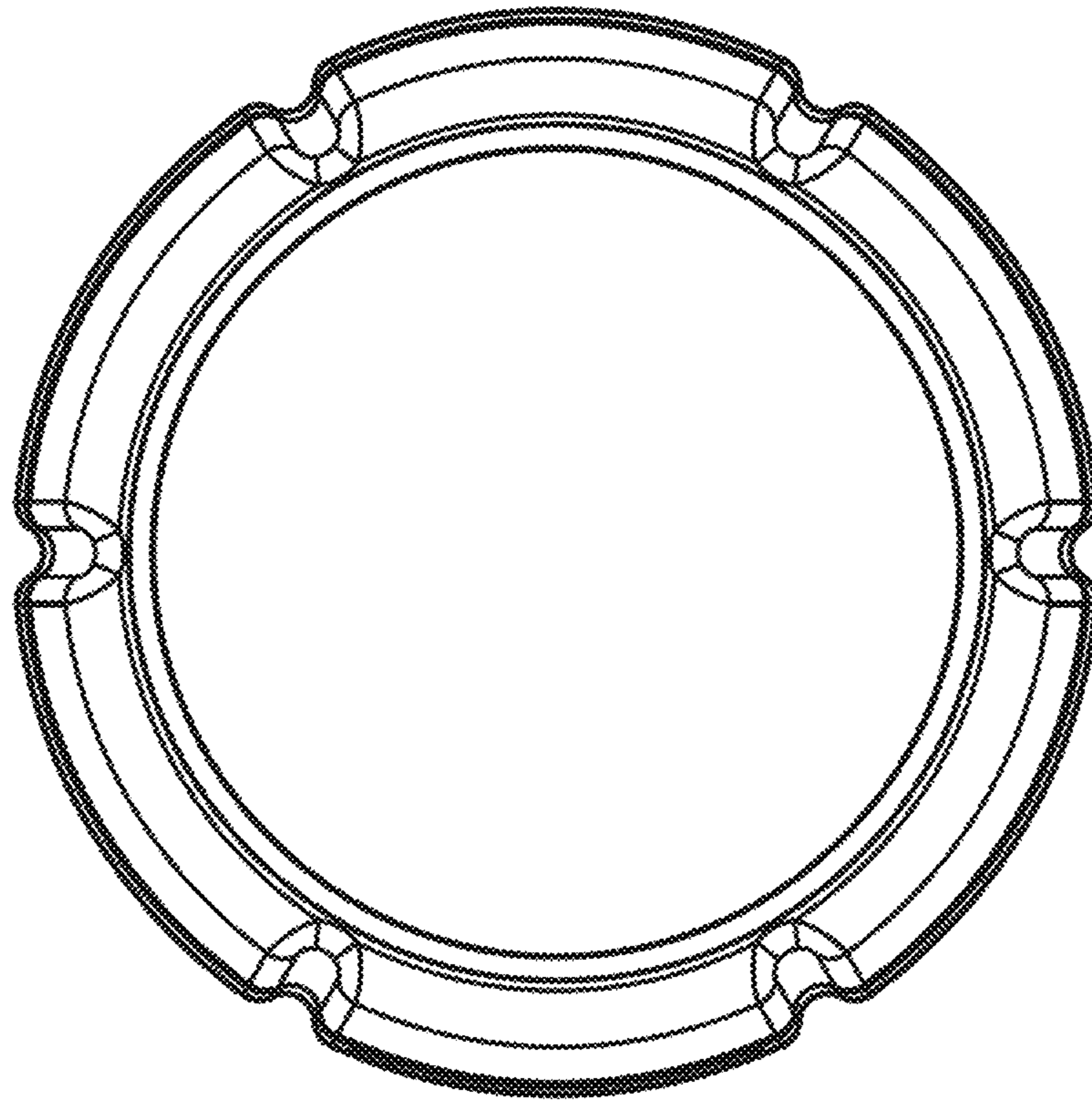

FIG. 6

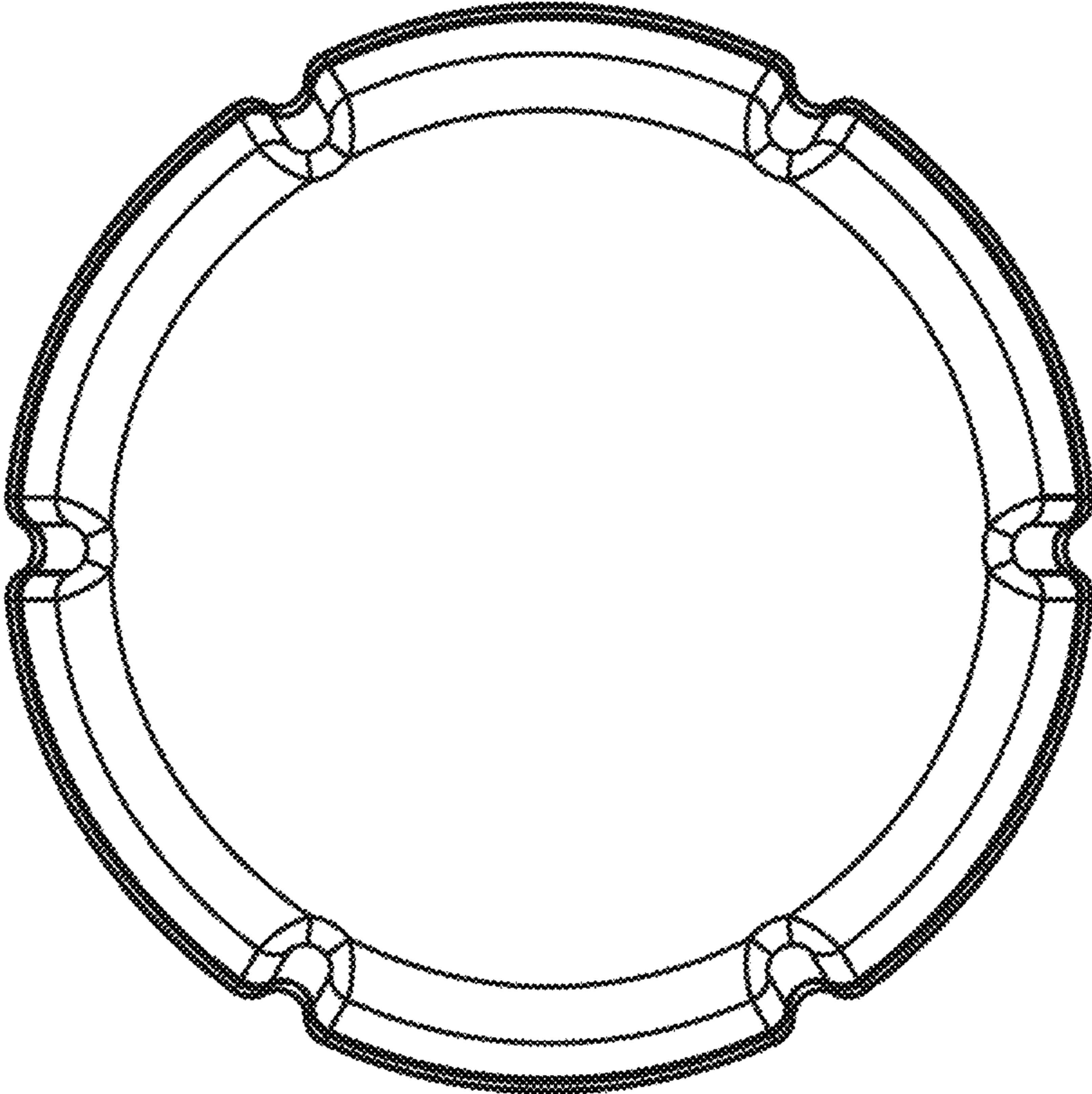

FIG. 7

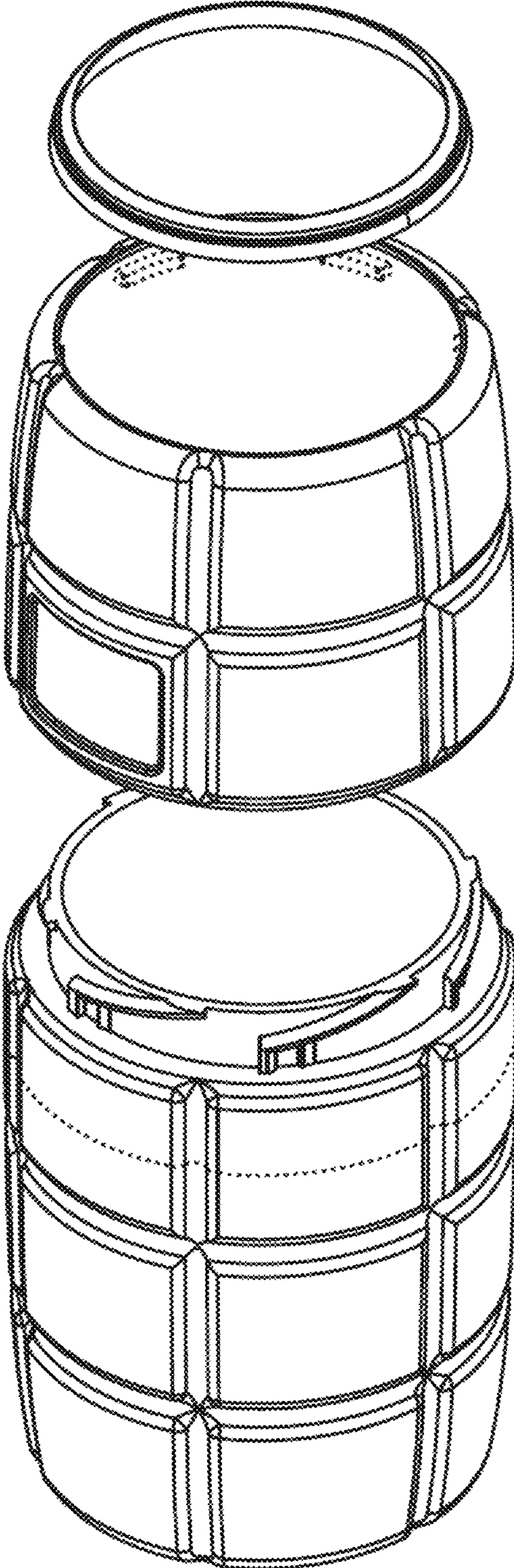

FIG. 8