



US00D921226S

(12) **United States Design Patent**
Barnds et al.

(10) **Patent No.:** **US D921,226 S**
(45) **Date of Patent:** **** Jun. 1, 2021**

(54) **POLYMER-BASED FLOORING**

(71) Applicant: **CPG International LLC**, Scranton, PA (US)

(72) Inventors: **Patrick Michael Barnds**, Birmingham, MI (US); **Jason Andrew Davoll**, Chicago, IL (US)

(73) Assignee: **CPG International LLC**, Scranton, PA (US)

(**) Term: **15 Years**

(21) Appl. No.: **29/679,753**

(22) Filed: **Feb. 8, 2019**

(51) **LOC (13) Cl.** **25-01**

(52) **U.S. Cl.**
USPC **D25/138**

(58) **Field of Classification Search**
USPC D25/138
CPC E04F 15/02044; E04F 15/02194; E04F 15/022; E04F 15/02405; E04F 15/02417; E04F 15/04; E04F 15/045; E04F 15/046; E04F 15/048; E04F 15/06; E04F 15/12
See application file for complete search history.

(56) **References Cited**

U.S. PATENT DOCUMENTS

D387,439 S *	12/1997	Ormiston	D25/138
D482,140 S *	11/2003	Hughes	D25/121
D598,576 S *	8/2009	Henriquez	D25/138
7,897,005 B2 *	3/2011	Knauseder	C09J 5/00 156/304.5
D642,287 S *	7/2011	Poland	D25/119

(Continued)

Primary Examiner — Doris Clark

(74) *Attorney, Agent, or Firm* — Shook, Hardy & Bacon L.L.P.

(57) **CLAIM**

The ornamental design for a polymer-based flooring, as shown and described.

DESCRIPTION

FIG. 1 is a perspective view of a polymer-based flooring showing our design according to a first embodiment; FIG. 2 is a top view thereof; FIG. 3 is a bottom view thereof; FIG. 4 is a first side view thereof; FIG. 5 is a second side view thereof; FIG. 6 is a cross section view taken along lines 6-6 of FIG. 1; FIG. 7 is a front view thereof; FIG. 8 is a back view thereof; FIG. 9 is a perspective view of a polymer-based flooring showing our design according to a second embodiment; FIG. 10 is a top view thereof; FIG. 11 is a bottom view thereof; FIG. 12 is a first side view thereof; FIG. 13 is a second side view thereof; FIG. 14 is a cross section view taken along lines 14-14 of FIG. 9; FIG. 15 is a front view thereof; FIG. 16 is a back view thereof; FIG. 17 is a perspective view of a polymer-based flooring showing our design according to a third embodiment; FIG. 18 is a top view thereof; FIG. 19 is a bottom view thereof; FIG. 20 is a first side view thereof; FIG. 21 is a second side view thereof; FIG. 22 is a cross section view taken along lines 22-22 of FIG. 17; FIG. 23 is a front view thereof; and, FIG. 24 is a back view thereof.

The even-length broken lines are directed to environment, represent unclaimed subject matter, and form no part of the claimed design.

The long-and-short broken lines form an unclaimed boundary, and form no part of the claim.

1 Claim, 9 Drawing Sheets

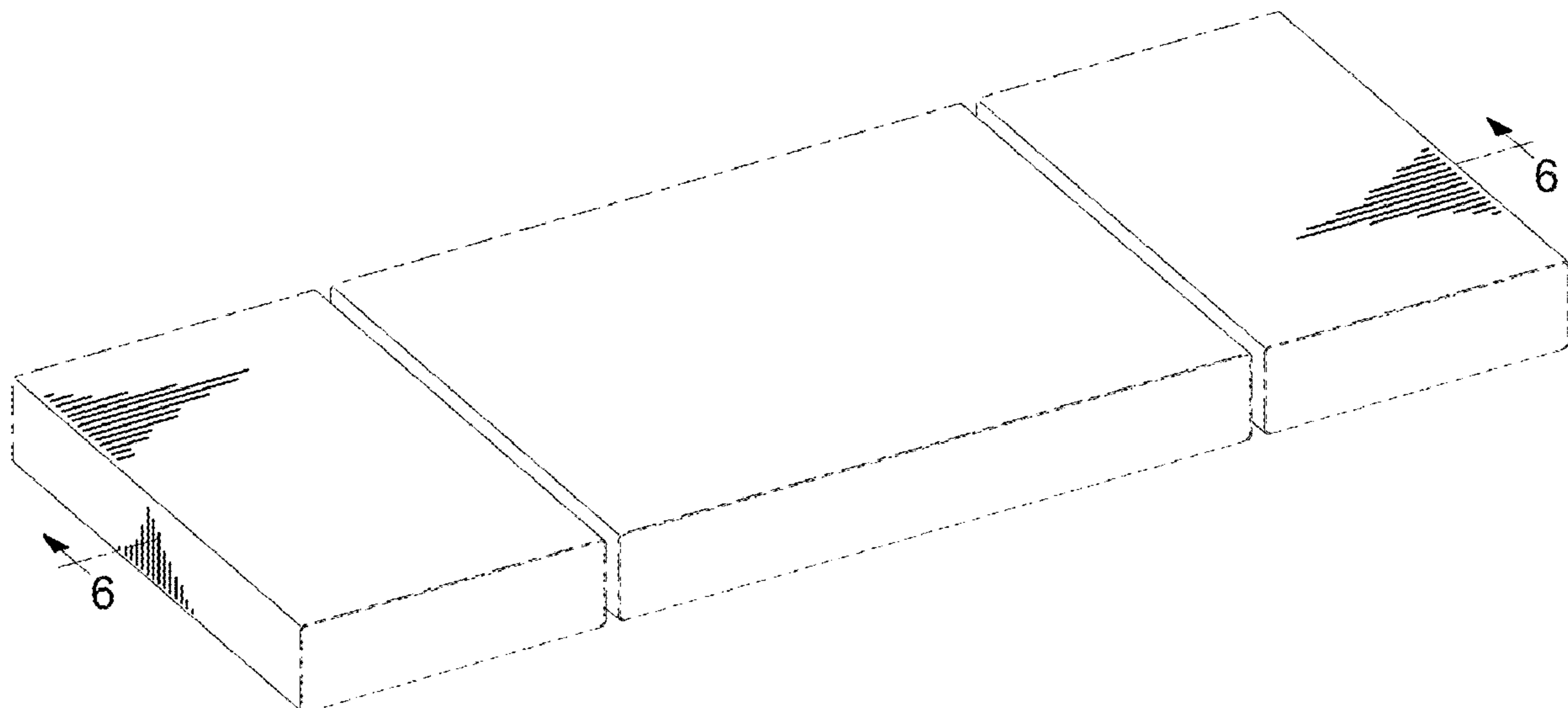

(56)

References Cited

U.S. PATENT DOCUMENTS

D654,599 S * 2/2012 Cupec D25/138
D667,965 S * 9/2012 Tuan D25/138
8,800,245 B1 * 8/2014 Pien B32B 3/30
52/747.11
D715,460 S * 10/2014 Smith D25/138
D751,223 S * 3/2016 Muxlow D25/138
D802,169 S * 11/2017 Lee D25/138
9,944,050 B2 * 4/2018 Kanao B32B 9/04
10,035,358 B2 * 7/2018 Pervan B41J 3/407
10,174,509 B2 * 1/2019 Hayes B32B 5/028
10,214,914 B2 * 2/2019 Bachelder E04F 15/02161
D857,251 S * 8/2019 Mussini D25/160

* cited by examiner

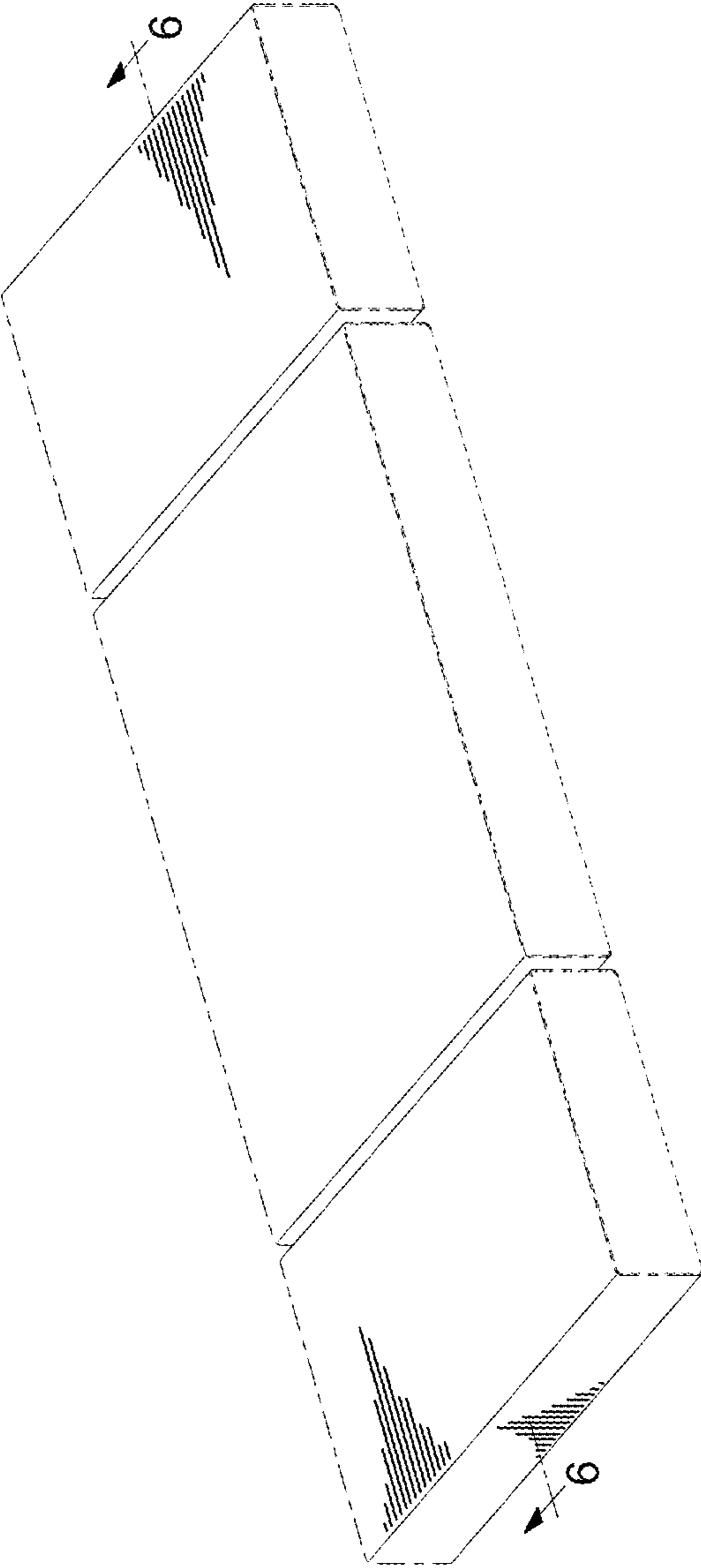

FIG. 1

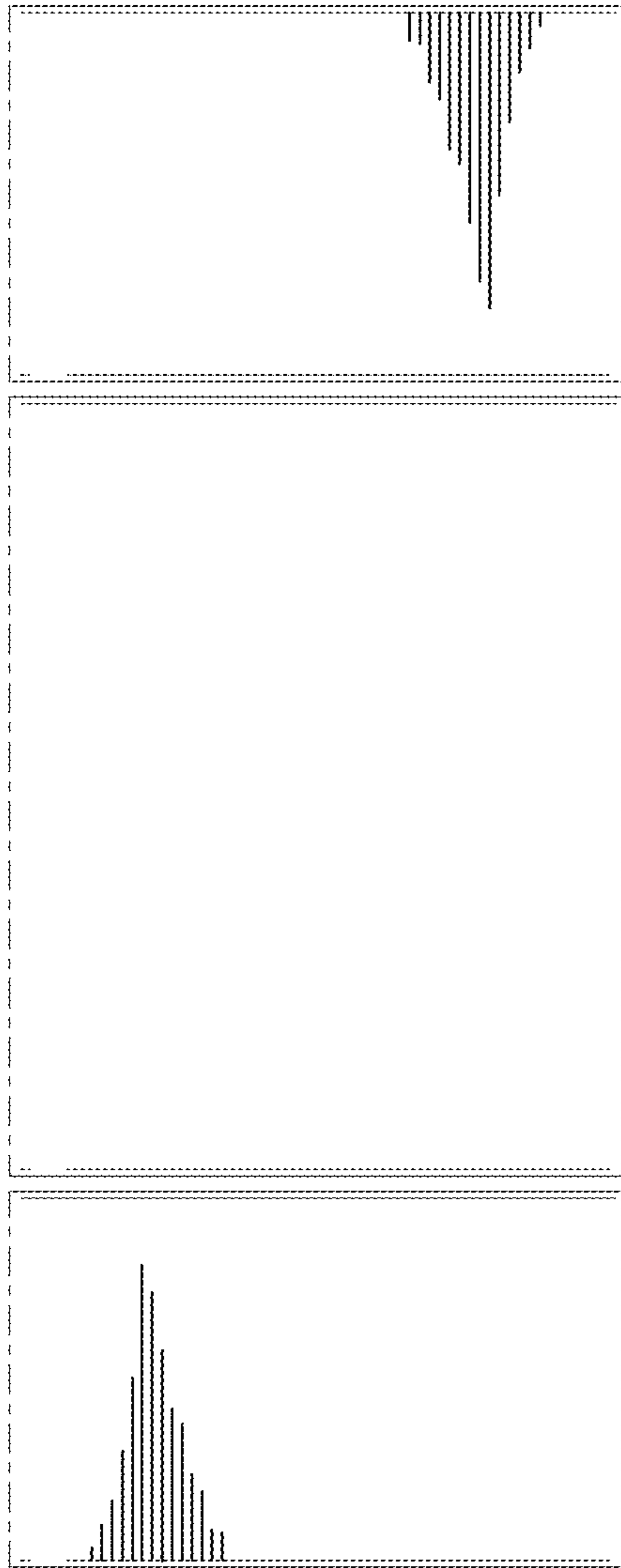

FIG. 2

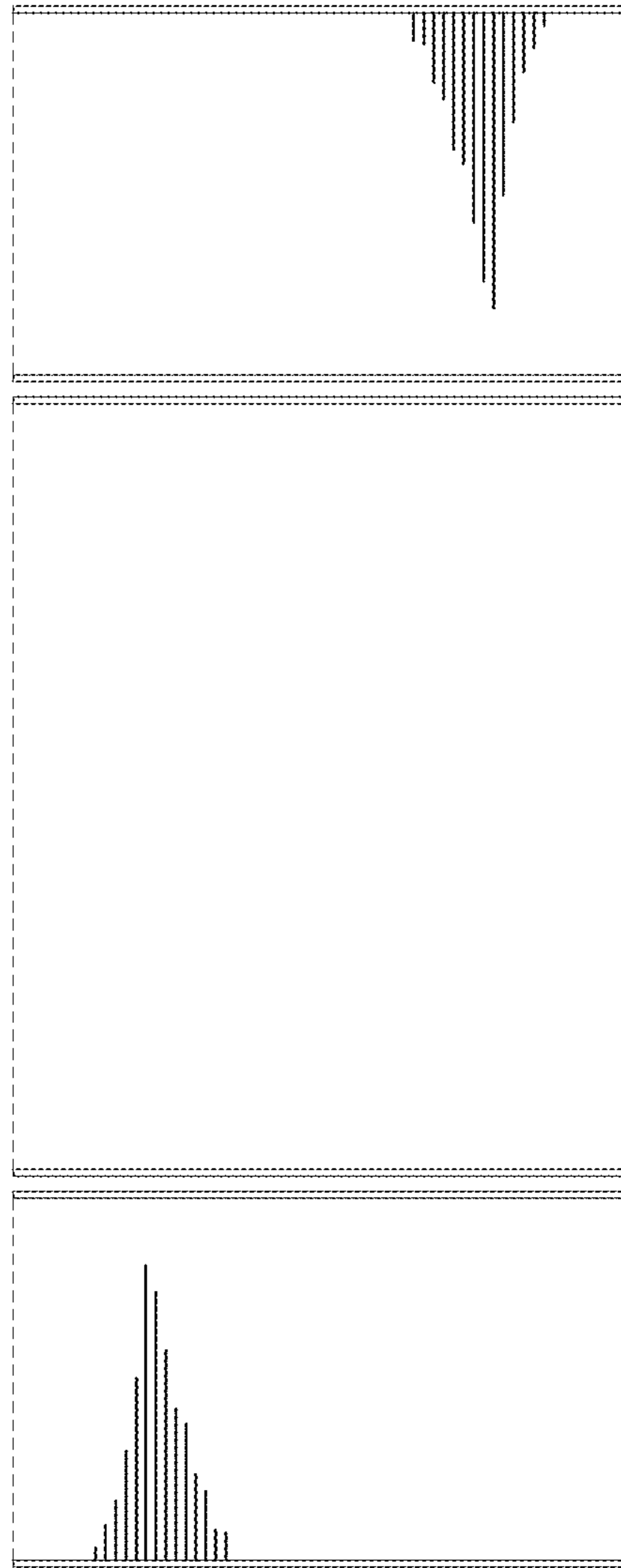

FIG. 3

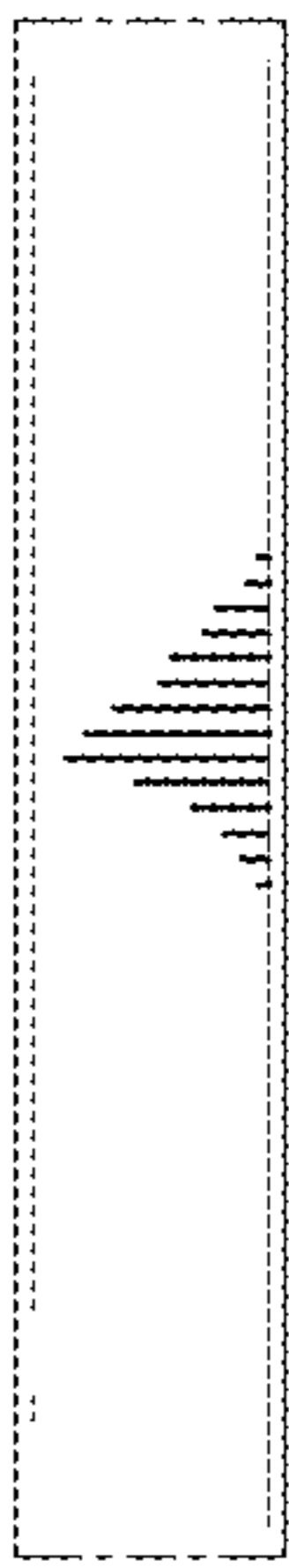

FIG. 4

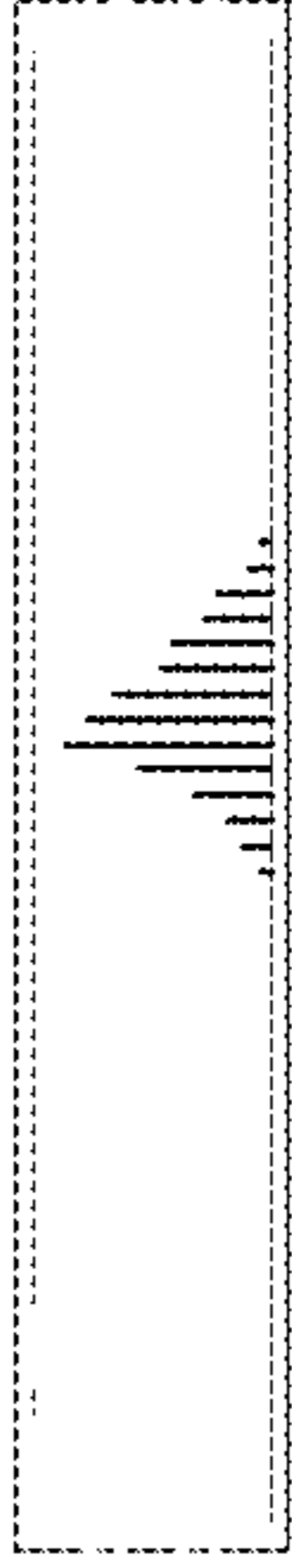

FIG. 5

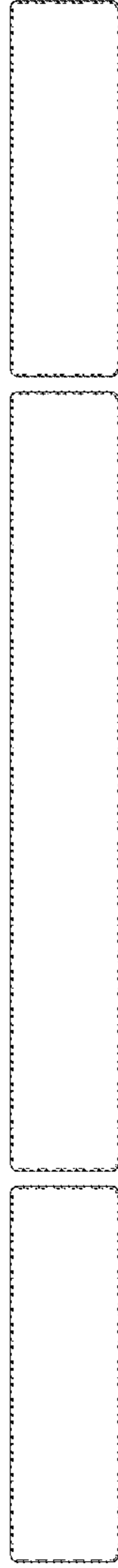

FIG. 6



FIG. 7

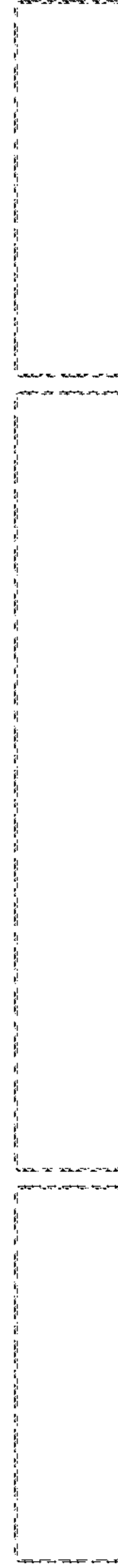

FIG. 8

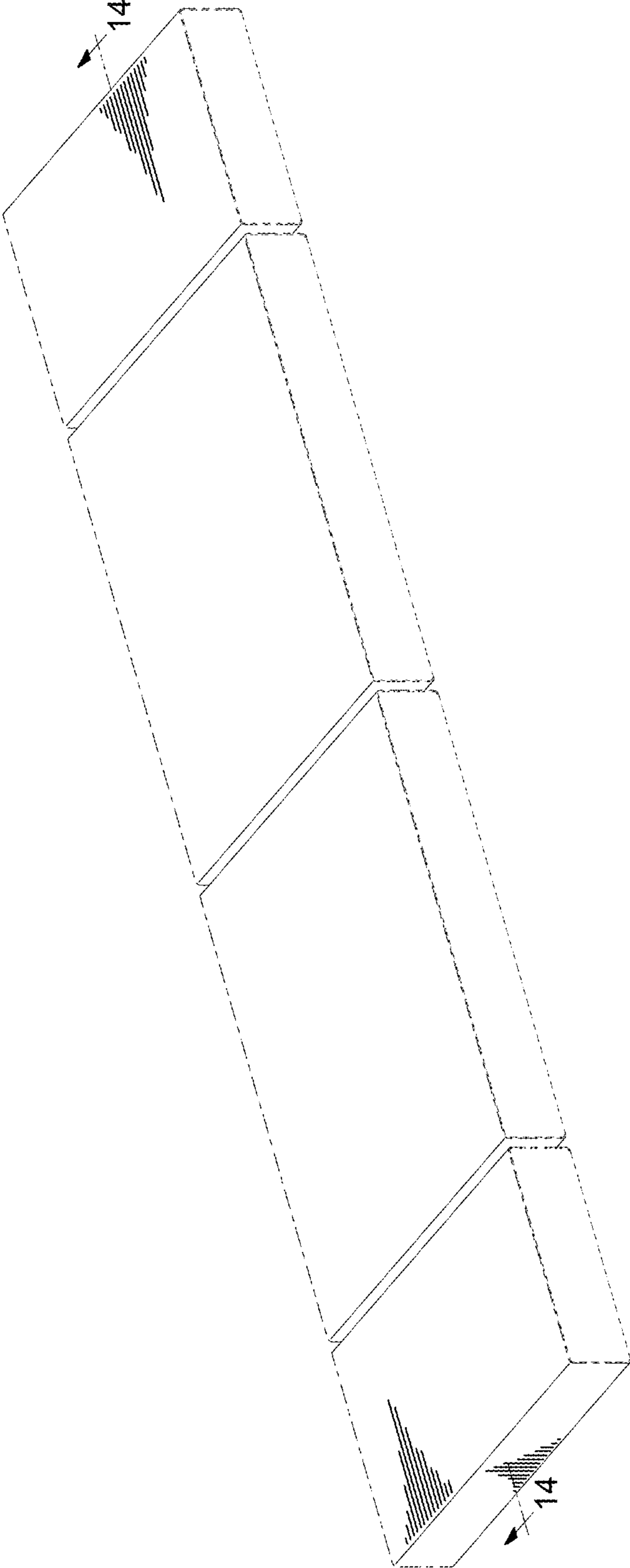
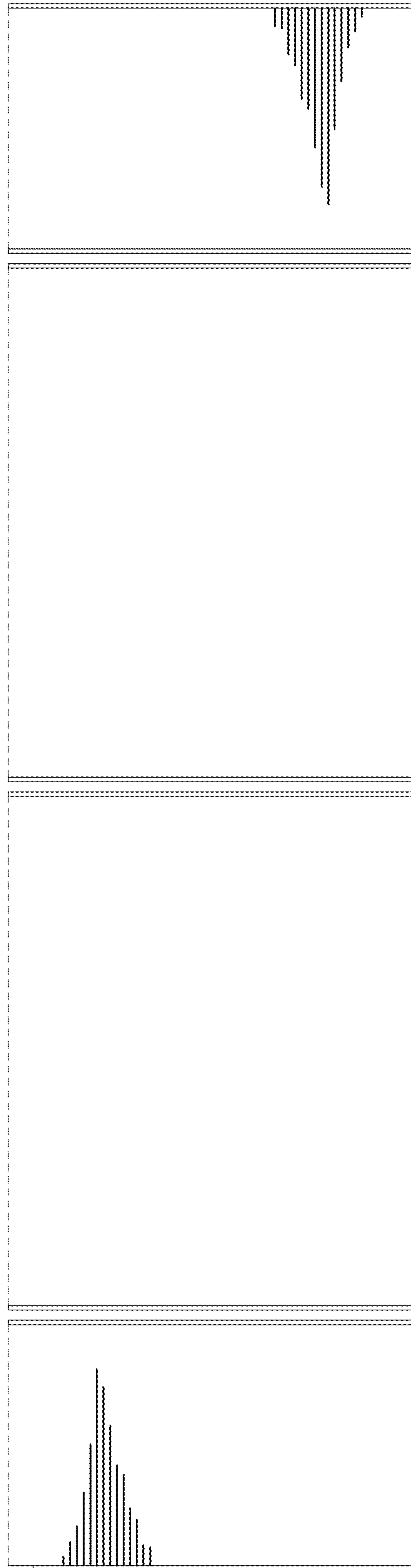
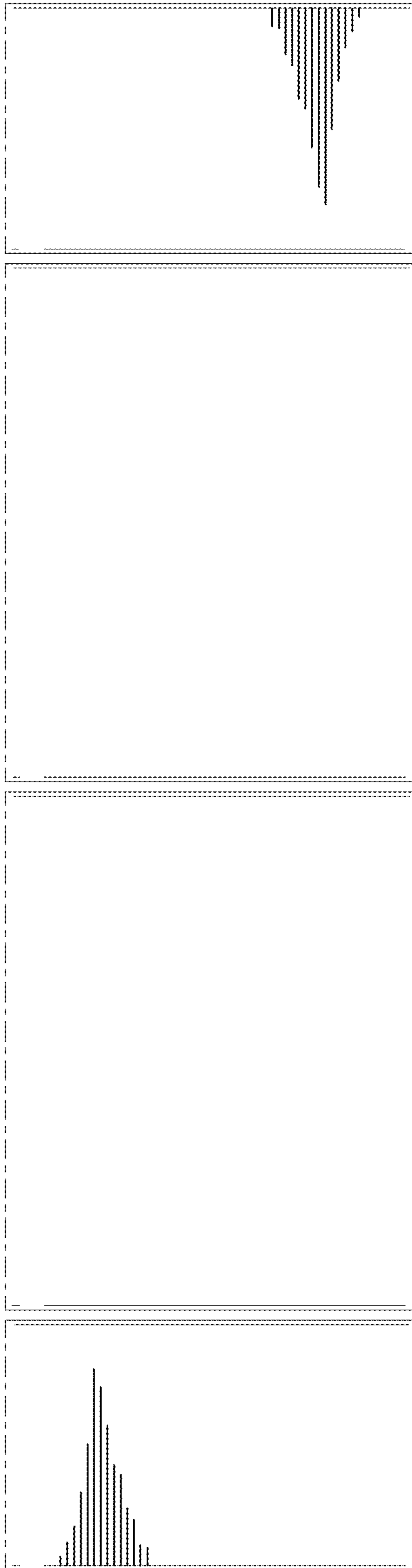

FIG. 9



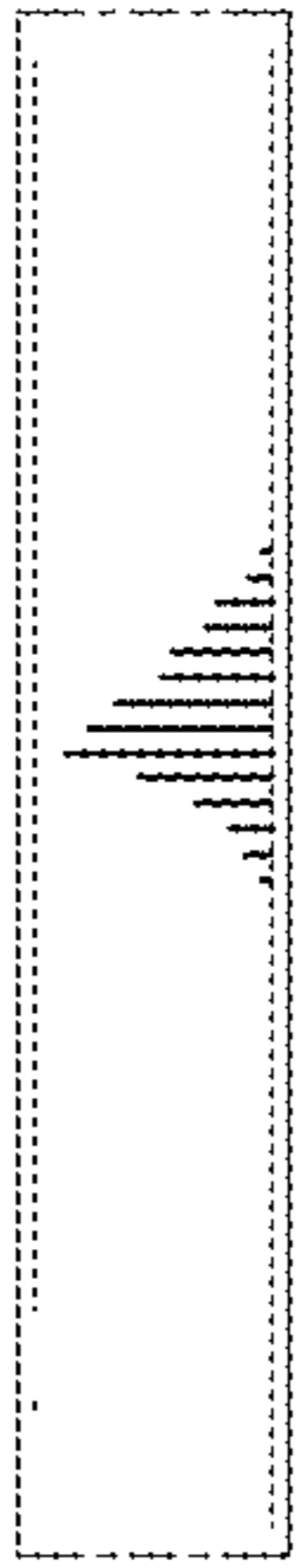

FIG. 12



FIG. 13

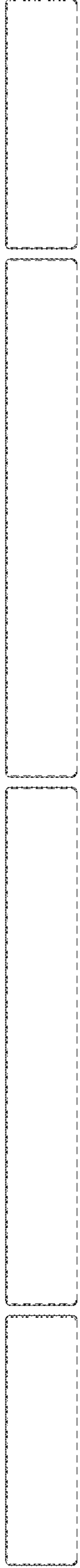

FIG. 14



FIG. 15



FIG. 16

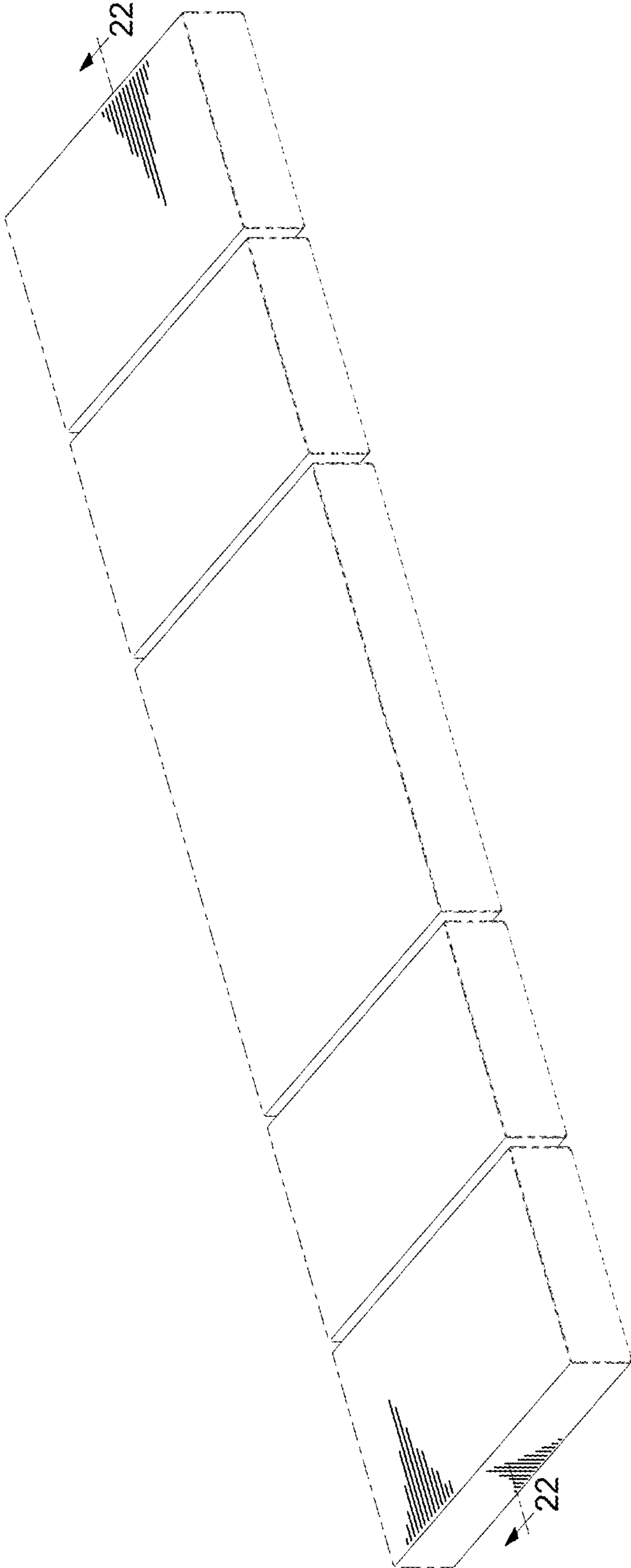

FIG. 17

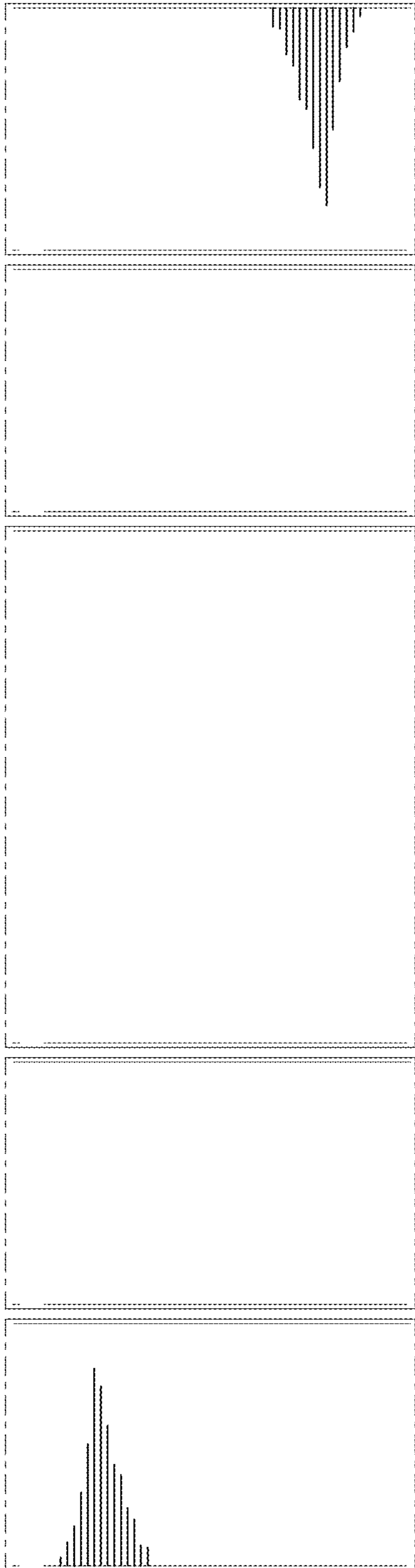

FIG. 18

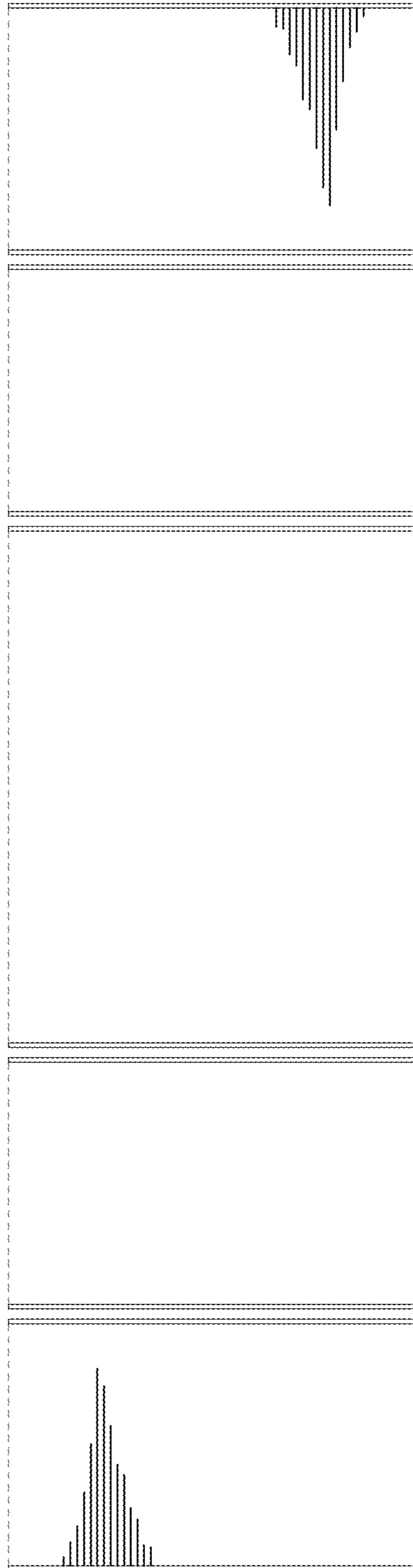

FIG. 19

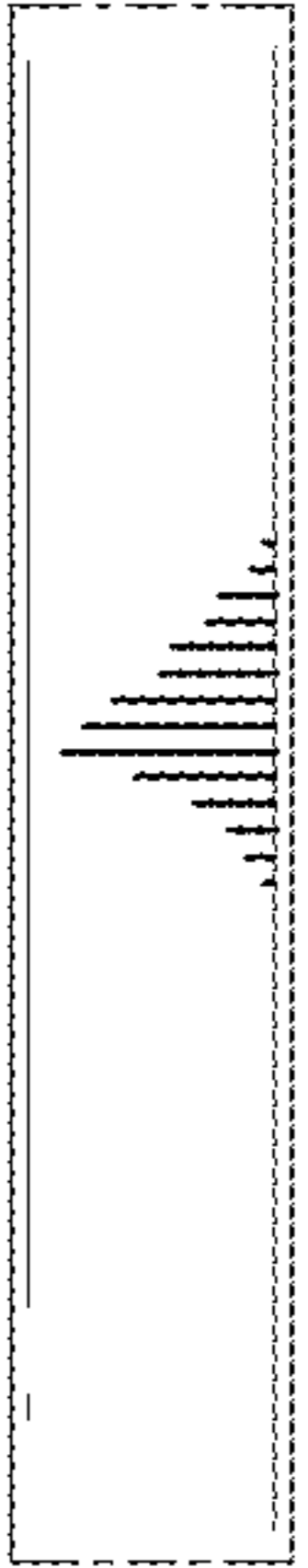

FIG. 20

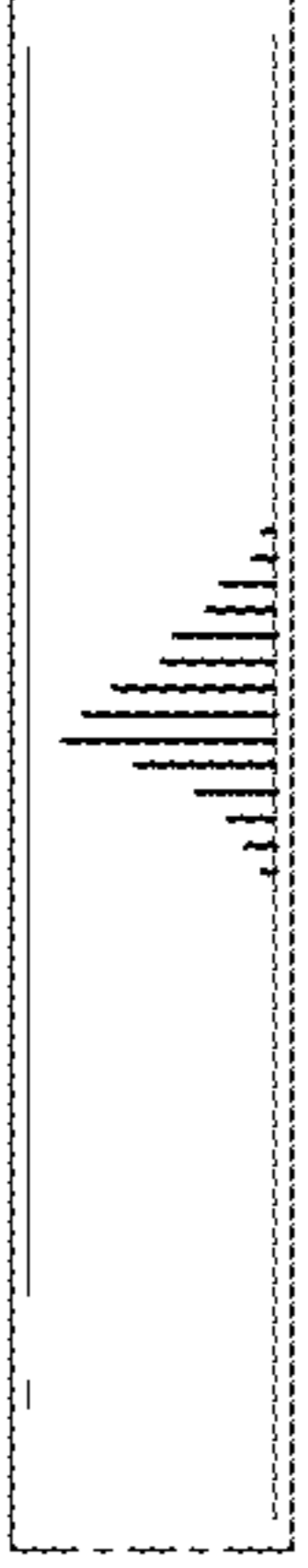

FIG. 21

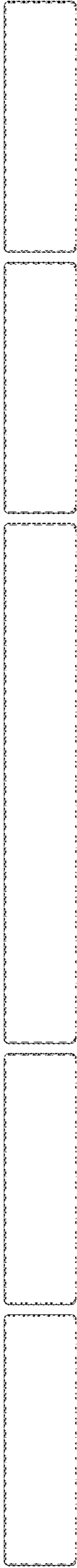

FIG. 22

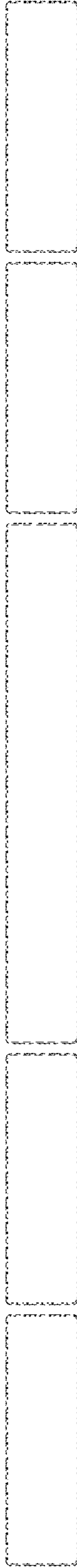

FIG. 23



FIG. 24