



US00D921217S

(12) **United States Design Patent**
Baratz et al.

(10) **Patent No.:** **US D921,217 S**
(45) **Date of Patent:** **** Jun. 1, 2021**

(54) **MIXING CAPSULE**

(71) Applicant: **DENTSPLY SIRONA Inc.**, York, PA (US)

(72) Inventors: **Adam Z. Baratz**, Broken Arrow, OK (US); **Sheridan L. Rose**, Broken Arrow, OK (US); **Stephen W. Rigsby**, Sand Springs, OK (US); **Todd P. Berger**, Owasso, OK (US)

(73) Assignee: **DENTSPLY SIRONA Inc.**, York, PA (US)

(**) Term: **15 Years**

(21) Appl. No.: **29/716,155**

(22) Filed: **Dec. 6, 2019**

(51) **LOC (13) Cl.** **24-01**

(52) **U.S. Cl.**
USPC **D24/220**

(58) **Field of Classification Search**
USPC D03/201, 203.1, 203.2, 203.3, 302;
D07/300.1, 372, 376, 377, 378, 414, 591,
(Continued)

(56) **References Cited**

U.S. PATENT DOCUMENTS

2,052,376 A * 8/1936 Zellers A61J 3/10
424/467
2,549,644 A * 4/1951 Silverman B01F 15/00824
366/349

(Continued)

OTHER PUBLICATIONS

College of Dentistry and Dental Clinics, "Operative Dentistry", first available Aug. 13, 2014. (<https://www.dentistry.uiowa.edu/operative-instruments-materials-dental-amalgam>) (Year: 2014).*

(Continued)

Primary Examiner — April Rivas

Assistant Examiner — Justin A Johnson

(74) *Attorney, Agent, or Firm* — Dentsply Sirona Inc.

(57) **CLAIM**

The ornamental design for a mixing capsule, as shown and described.

DESCRIPTION

FIG. 1 is a perspective view of a cover portion for a mixing capsule of the present invention;

FIG. 2 is a top plan view of the cover portion shown in FIG. 1;

FIG. 3 is a bottom plan view of the cover portion shown in FIG. 1;

FIG. 4 is a front plan view of the cover portion shown in FIG. 1;

FIG. 5 is a rear plan view of the cover portion shown in FIG. 1;

FIG. 6 is a left side view of the cover portion shown in FIG. 1;

FIG. 7 is a left side cross-sectional view of the cover portion shown in FIG. 4;

FIG. 8 is a right side view of the cover portion shown in FIG. 1;

FIG. 9 is a right side cross-sectional view of the cover portion shown in FIG. 5;

FIG. 10 is a perspective view of a base portion of the mixing capsule of the present invention;

FIG. 11 is a bottom plan view of the base portion shown in FIG. 10;

FIG. 12 is a top plan view of the base portion shown in FIG. 10;

FIG. 13 is a front plan view of the base portion shown in FIG. 10;

FIG. 14 is a rear plan view of the base portion shown in FIG. 10;

FIG. 15 is a left side view of the base portion shown in FIG. 10;

FIG. 16 is a right side view of the base portion shown in FIG. 10; and

FIG. 17 is a perspective view of the mixing capsule having a cover portion shown in FIG. 1 and a base shown in FIG. 10;

(Continued)

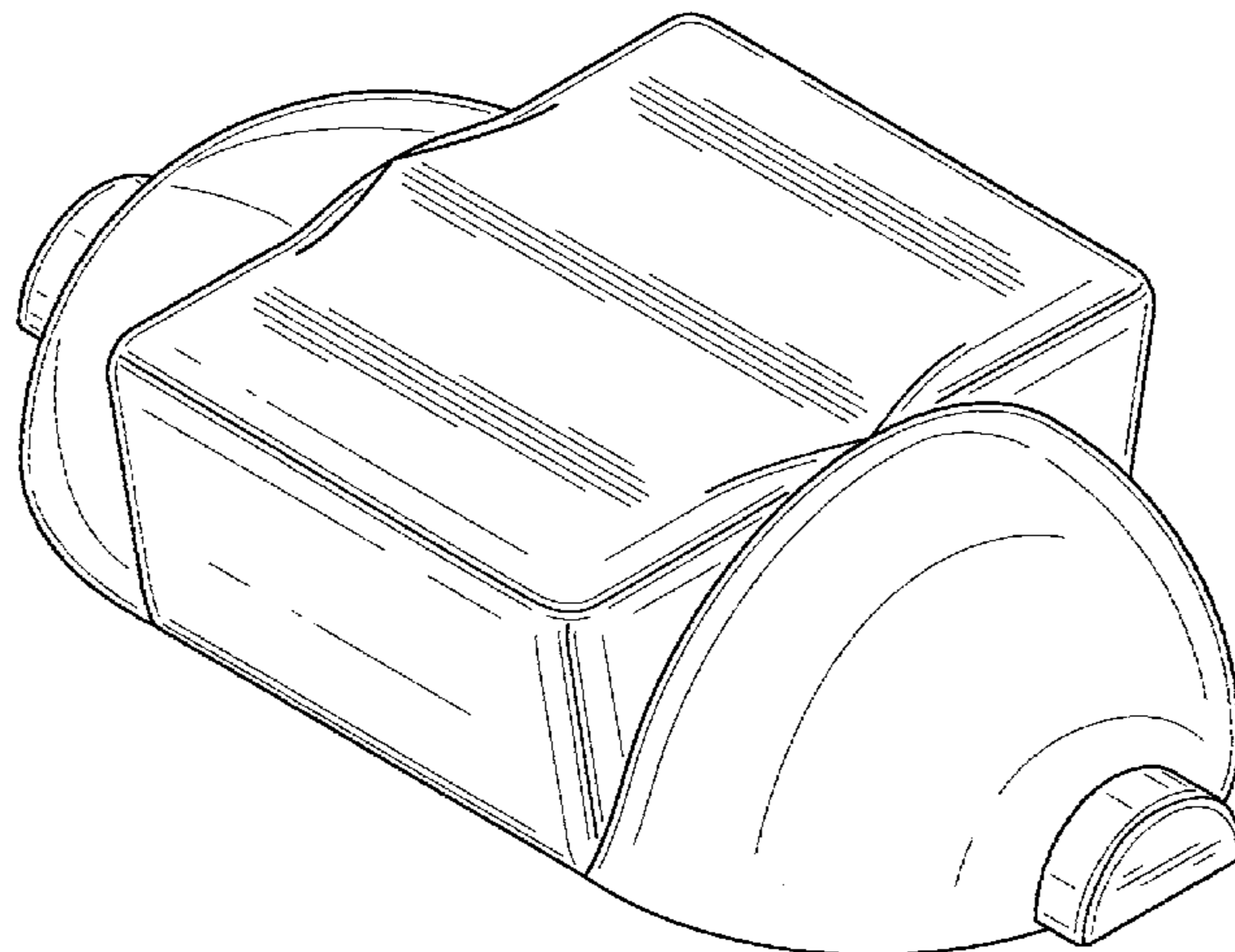

FIG. 18 is a top plan view of the mixing capsule shown in FIG. 17;
 FIG. 19 is a bottom plan view of the mixing capsule shown in FIG. 17;
 FIG. 20 is a front plan view of the mixing capsule shown in FIG. 17;
 FIG. 21 is a rear plan view of the mixing capsule shown in FIG. 17;
 FIG. 22 is a left side view of the mixing capsule shown in FIG. 17; and,
 FIG. 23 is a right side view of the mixing capsule shown in FIG. 17.
 The cover and the base are shown alone for convenience of illustration only.

1 Claim, 16 Drawing Sheets

(58) **Field of Classification Search**

USPC D07/667, 679, 688; D24/100, 101, 102, D24/103, 104, 141, 163, 220, 221, 231, D24/232; D27/100, 101, 163, 164, 165, D27/166, 167, 168, 169, 194
 CPC .. A42B 9/00; A42B 13/00; A24D 1/00; A24D 1/008; A24D 1/12; A24D 1/14; A24D 1/22; A61B 17/8802; A61J 1/00; A61J 1/03; A61K 2300/00; B01F 3/00; B01F 3/08; B01F 3/0853; B01F 3/0865; B01F 3/12; B01F 3/1221; B01F 3/18; B01F 3/184; B01F 3/20; B01F 3/2071; B01F 3/22; B01F 3/2276; B01F 7/00; B01F 7/00008; B01F 7/002; B01F 7/0075; B01F 7/02; B01F 7/021; B01F 9/00; B01F 9/001; B01F 13/0001; B01F 13/00; B01F 2215/0029; B01F 2215/0032; B01F 2215/0034; B01F 2215/0036; B01F 2215/0037; B01F 2215/0045; B01F

2215/0049; B28C 5/0881

See application file for complete search history.

(56)

References Cited

U.S. PATENT DOCUMENTS

3,831,742	A *	8/1974	Gardella	A61C 5/66 206/219
3,963,120	A *	6/1976	Perfect	A61C 5/66 206/219
4,362,242	A *	12/1982	Cheetham	A61C 5/66 206/219
4,557,376	A *	12/1985	Probst	B65D 81/32 206/219
5,746,313	A *	5/1998	Wilson	A61C 5/66 206/220
6,365,183	B1 *	4/2002	Edgren	A61K 9/2072 424/464
D479,684	S *	9/2003	Miller	A61K 9/2072 D3/302
D483,945	S *	12/2003	Tanji	A61K 9/2072 D3/273
7,780,985	B2 *	8/2010	Solomon	A61K 9/2072 424/467
D740,029	S *	10/2015	Otto	D3/302
2018/0200191	A1 *	7/2018	Lay	A61K 9/4808

OTHER PUBLICATIONS

Amazon, "ShakeSphere Tumbler", first available Feb. 11, 2019. (https://www.amazon.co.uk/ShakeSphere-Tumbler-Winning-Patented-Blending/dp/B07NLGP82S/ref=pd_rhf_eeolp_p_img_1?encoding=UTF8&psc=1&refRID=V2A01GJZ755FQCRD4SWC) (Year: 2019).*
 Jewelry and Findings, "Openable Plastic Bead Containers", first available Nov. 6, 2020. (<https://www.jewelryandfindings.com/p-2315399-openable-plastic-bead-containers-capsule-shaped-container-clear.html>) (Year: 2020).*
 Alibaba, "Dental Amalgam Capsule", first available Nov. 6, 2020. (https://www.alibaba.com/product-detail/Dental-Amalgam-Capsule-Alloy-43-Ag_561888877.html) (Year: 2020).*

* cited by examiner

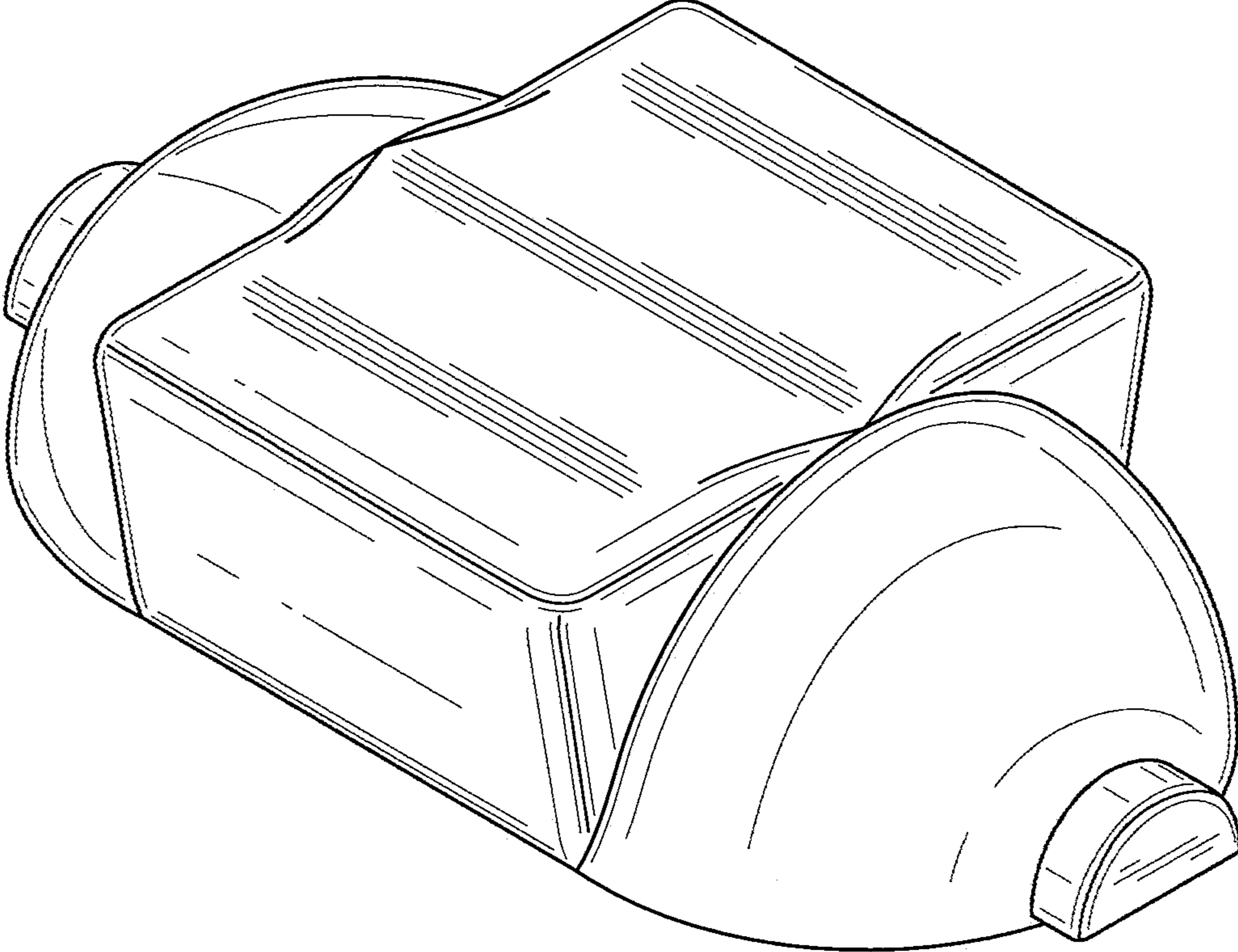

FIG. 1

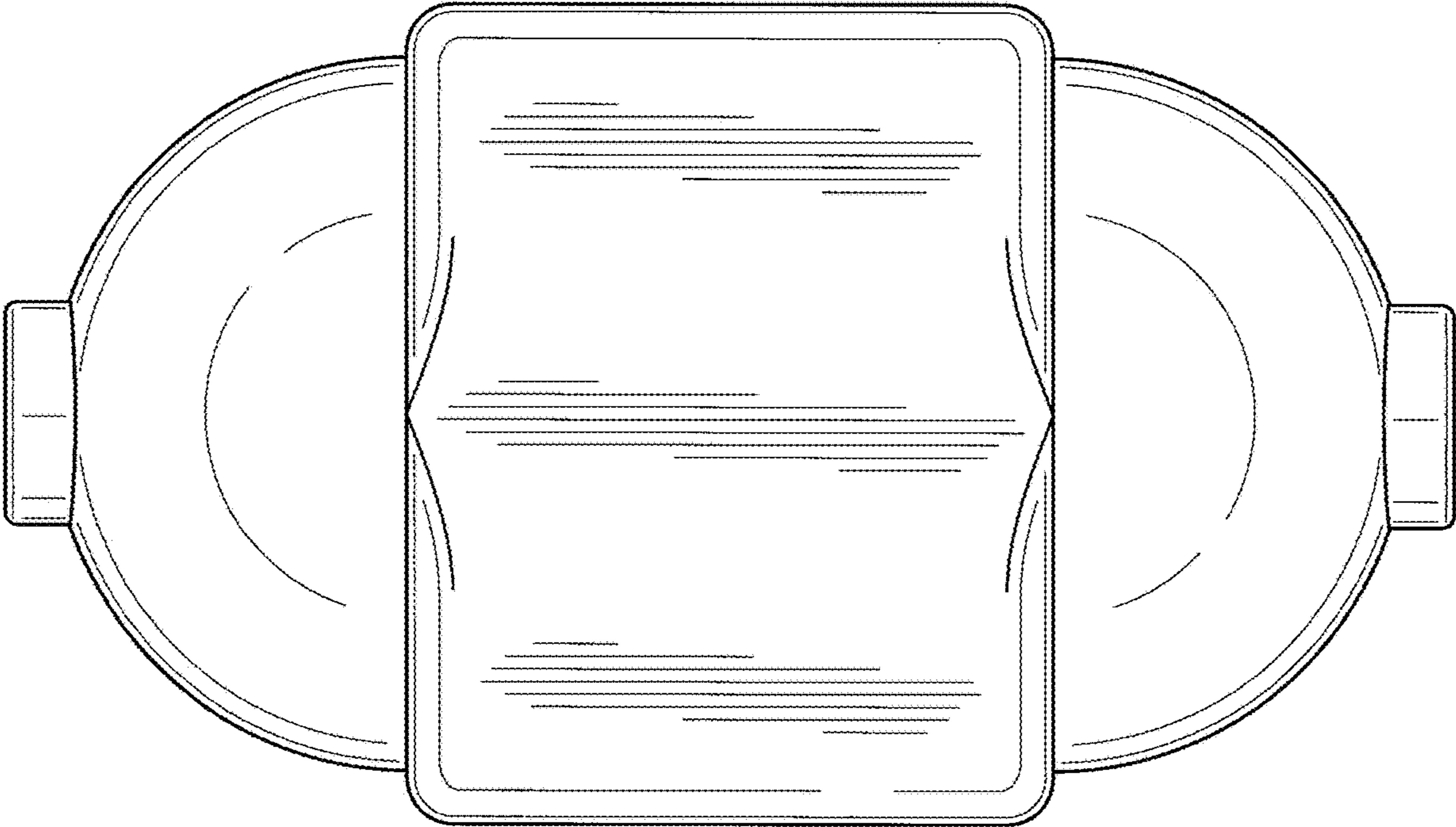

FIG. 2

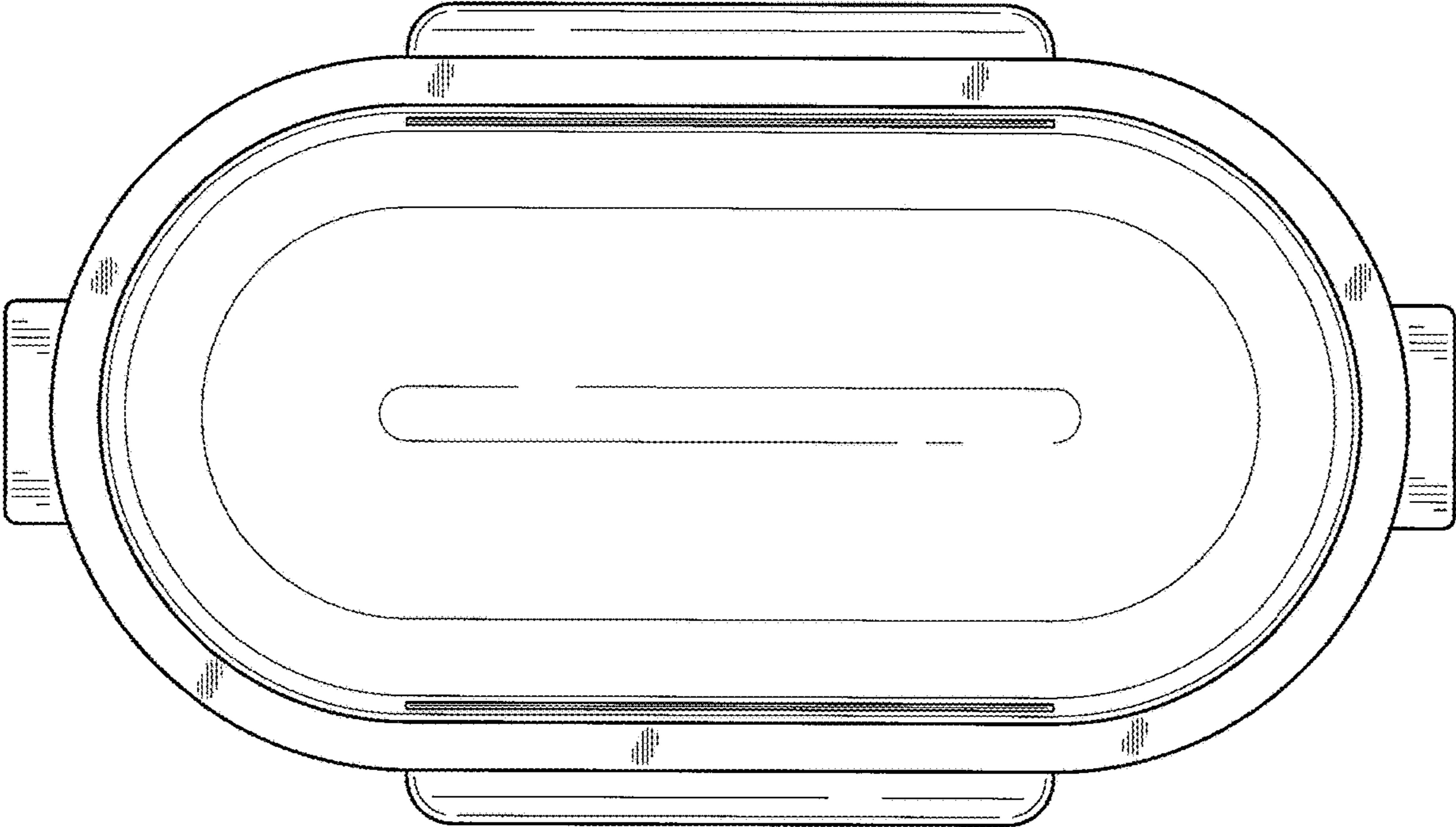

FIG. 3

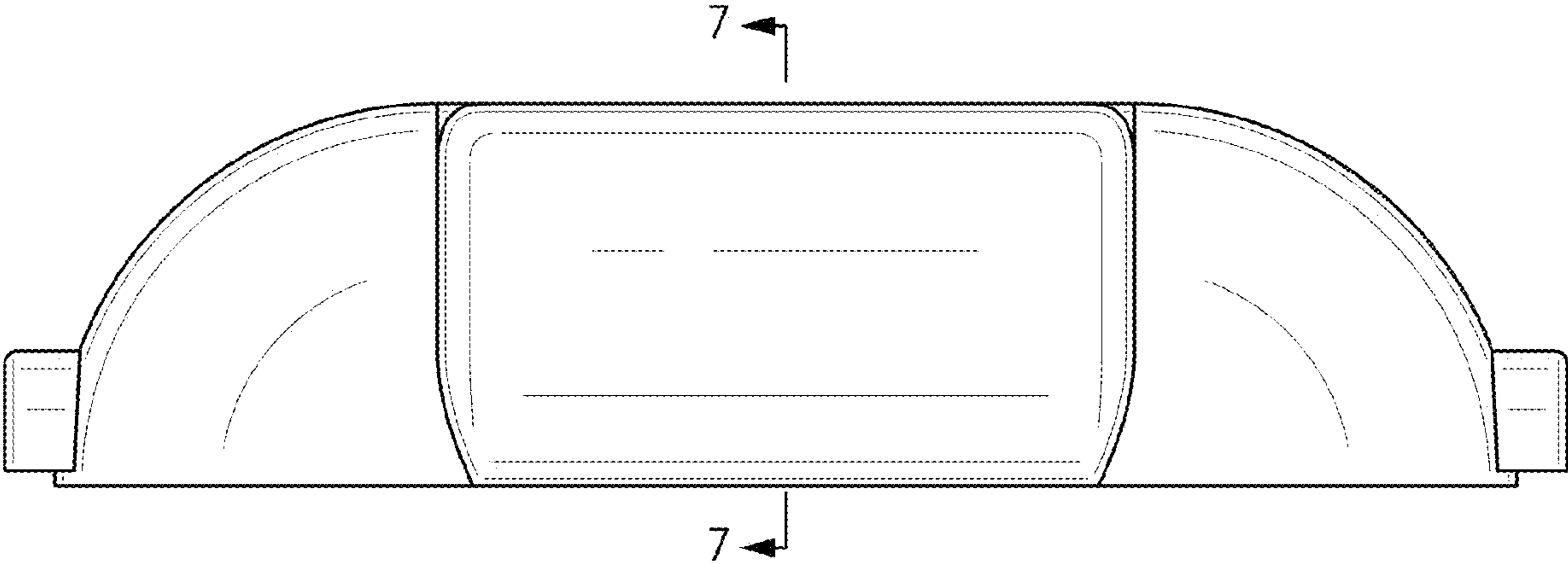

FIG. 4

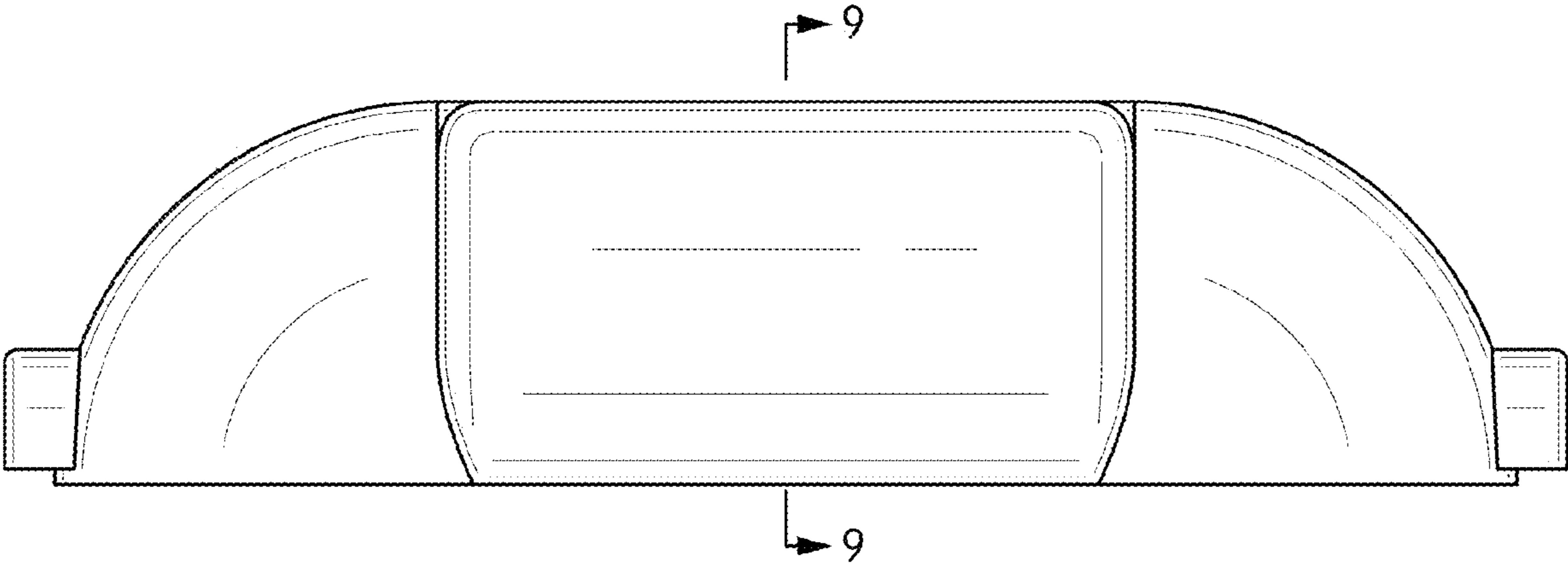

FIG. 5

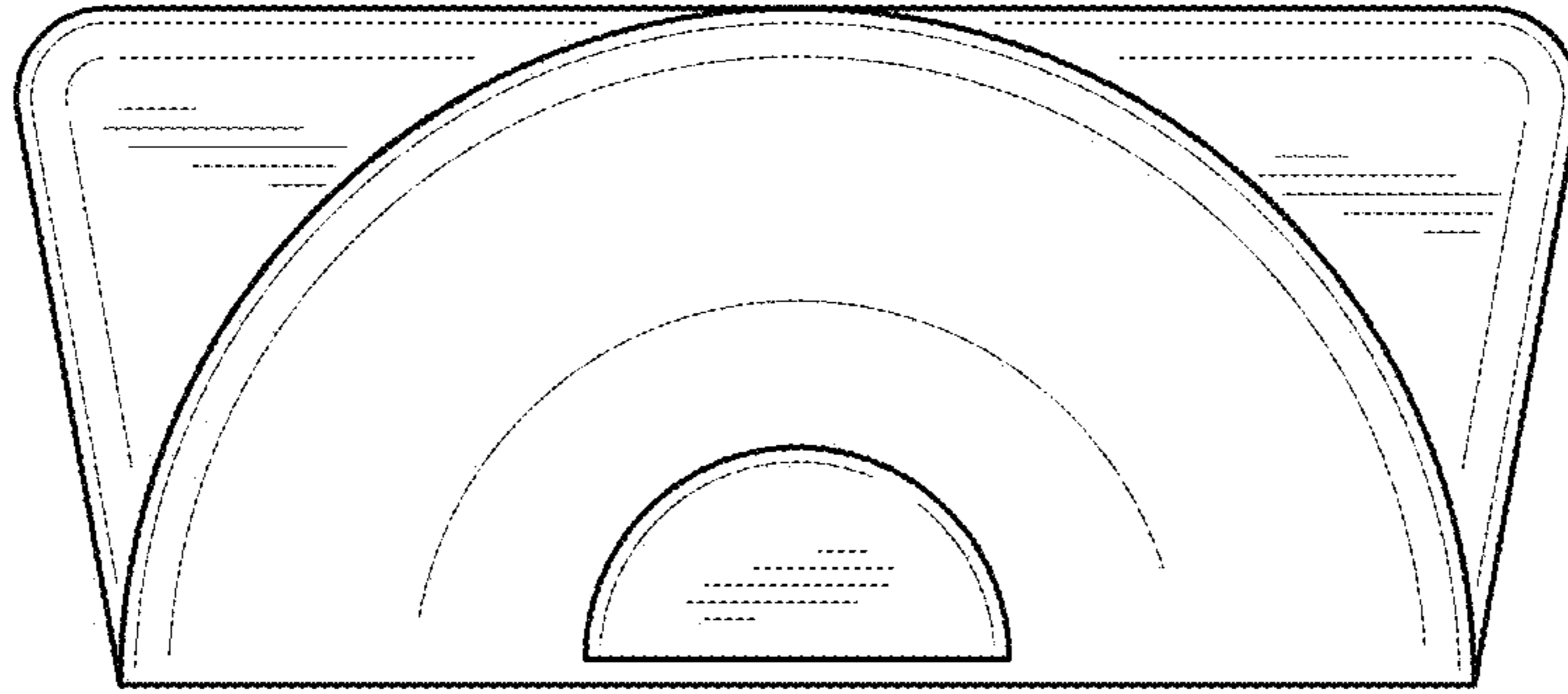

FIG. 6

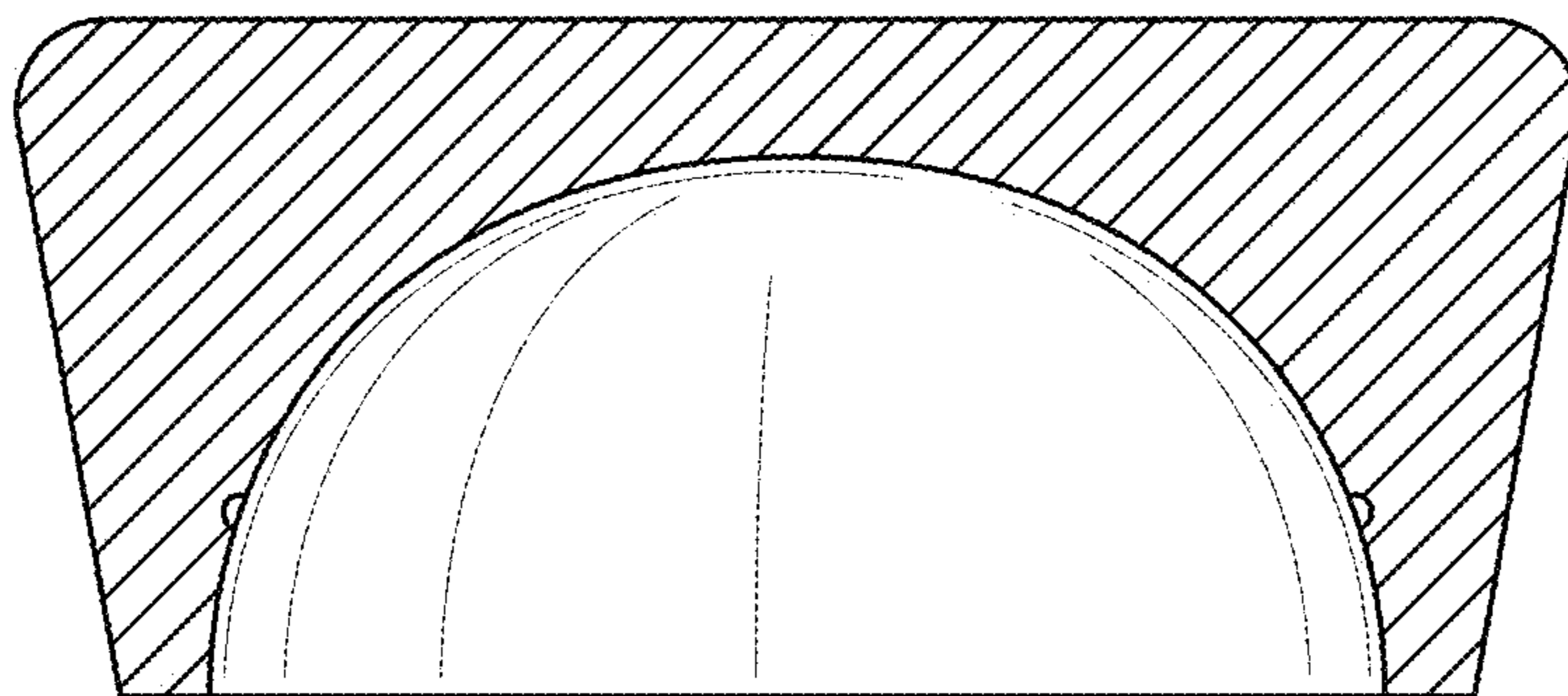

FIG. 7

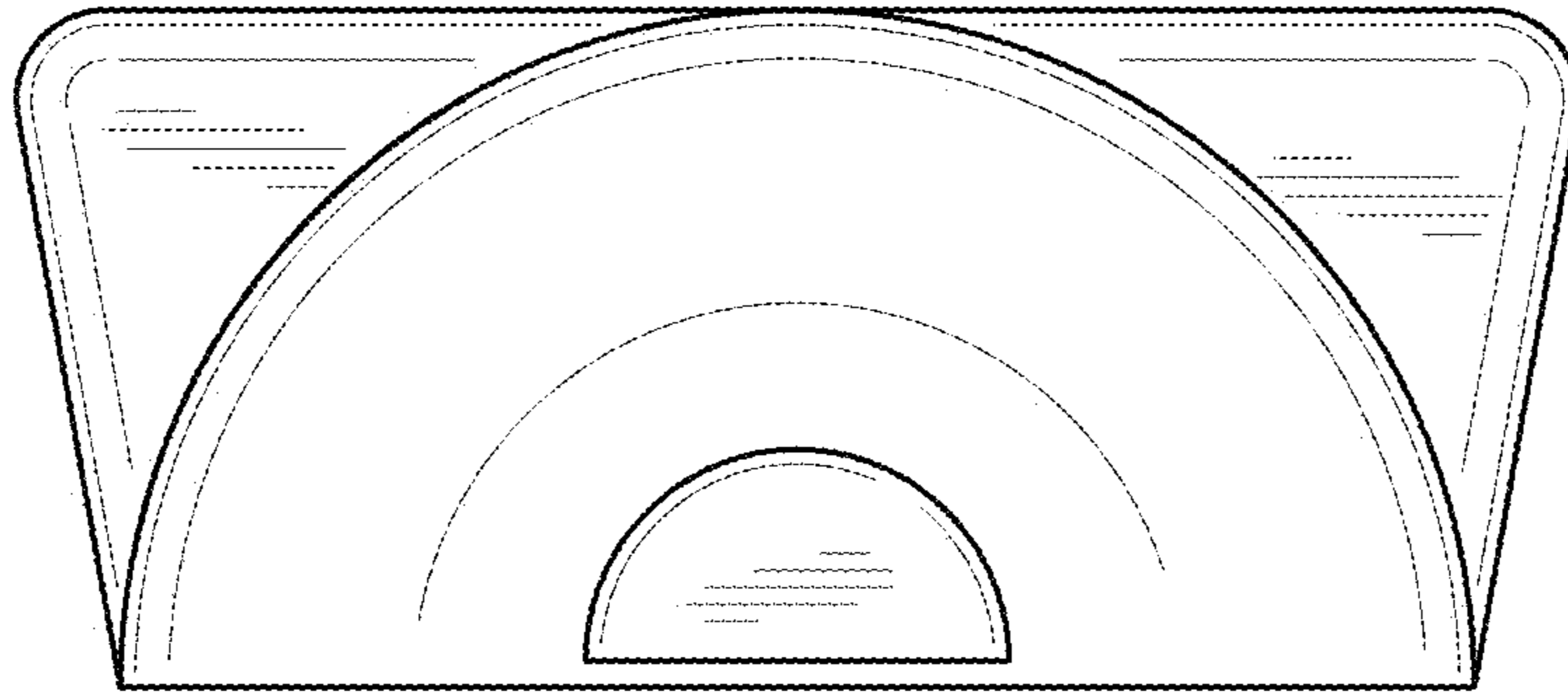

FIG. 8

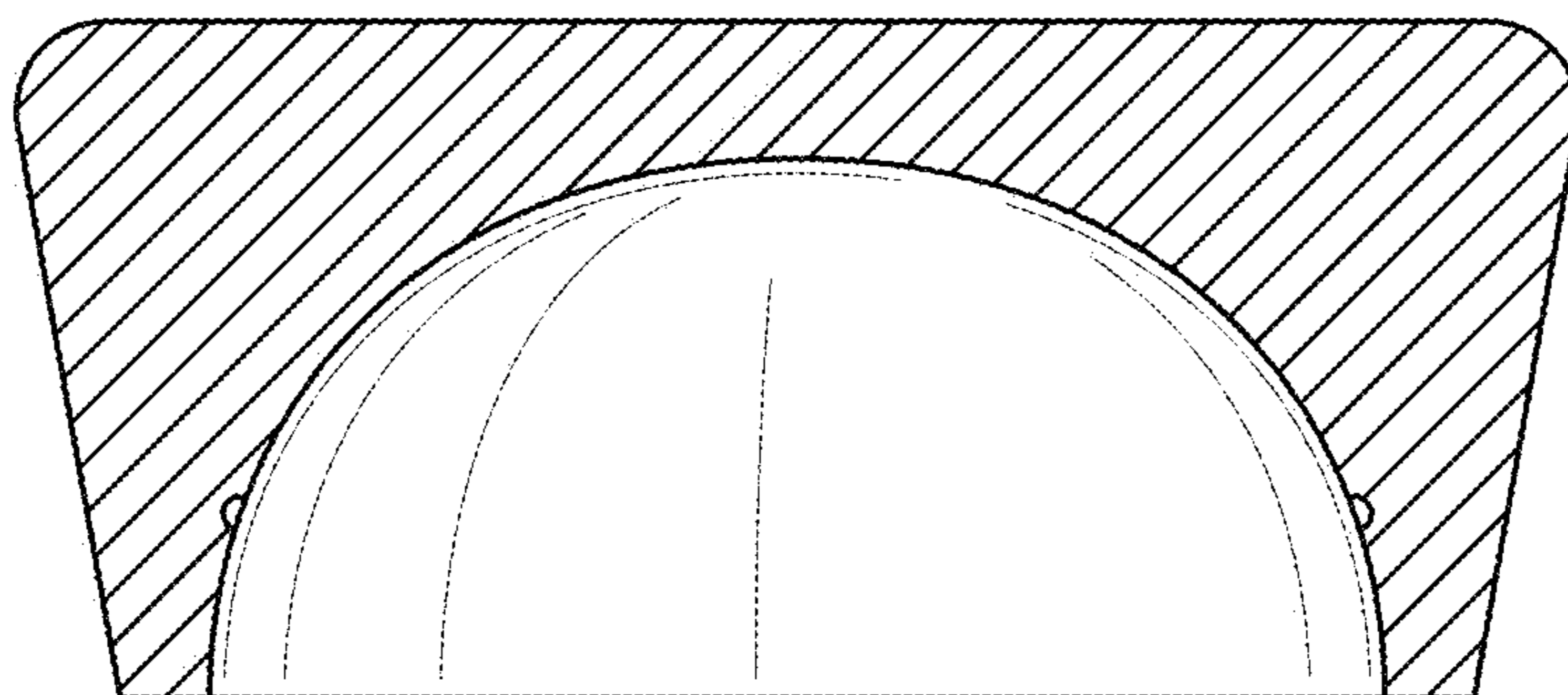

FIG. 9

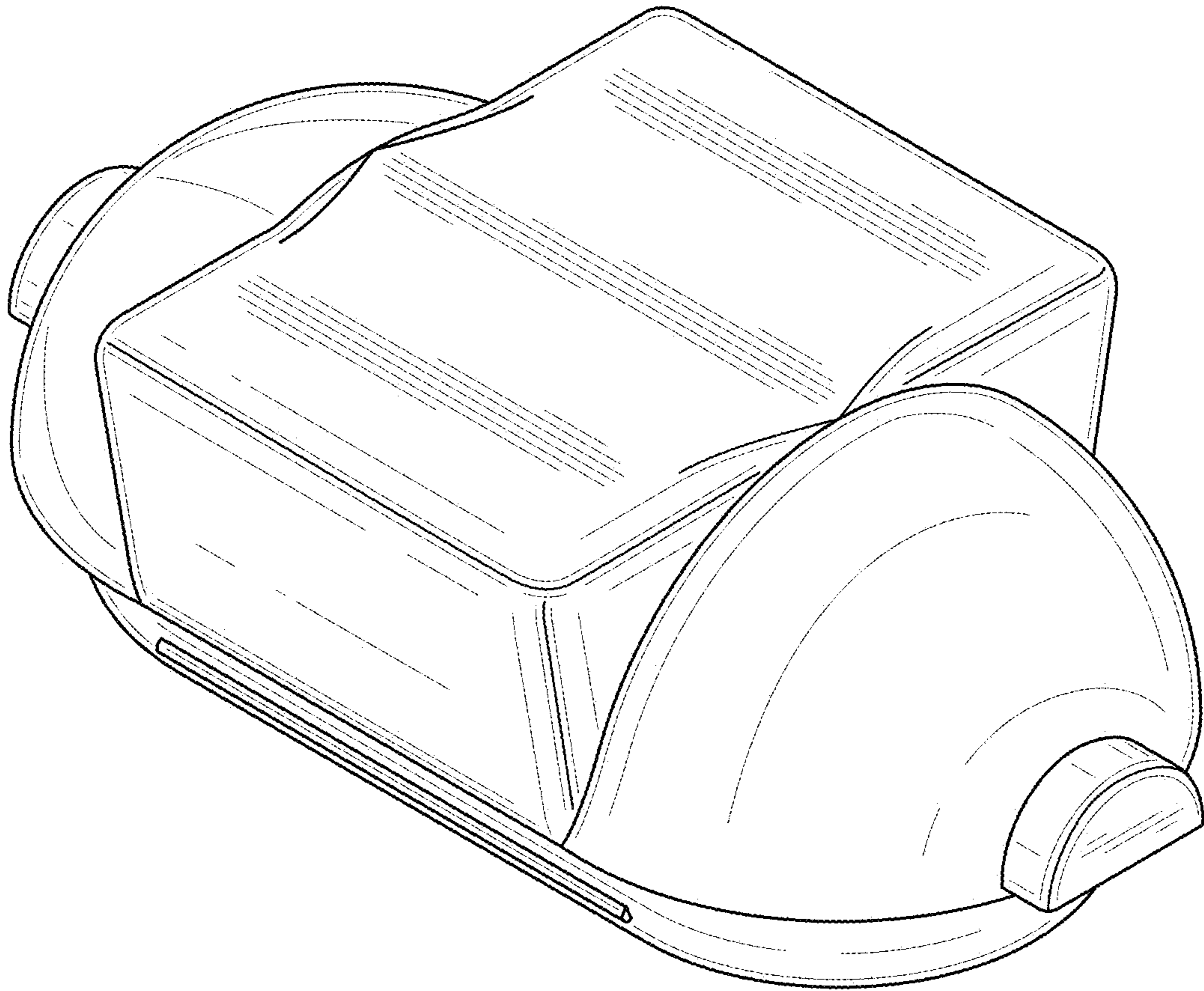

FIG. 10

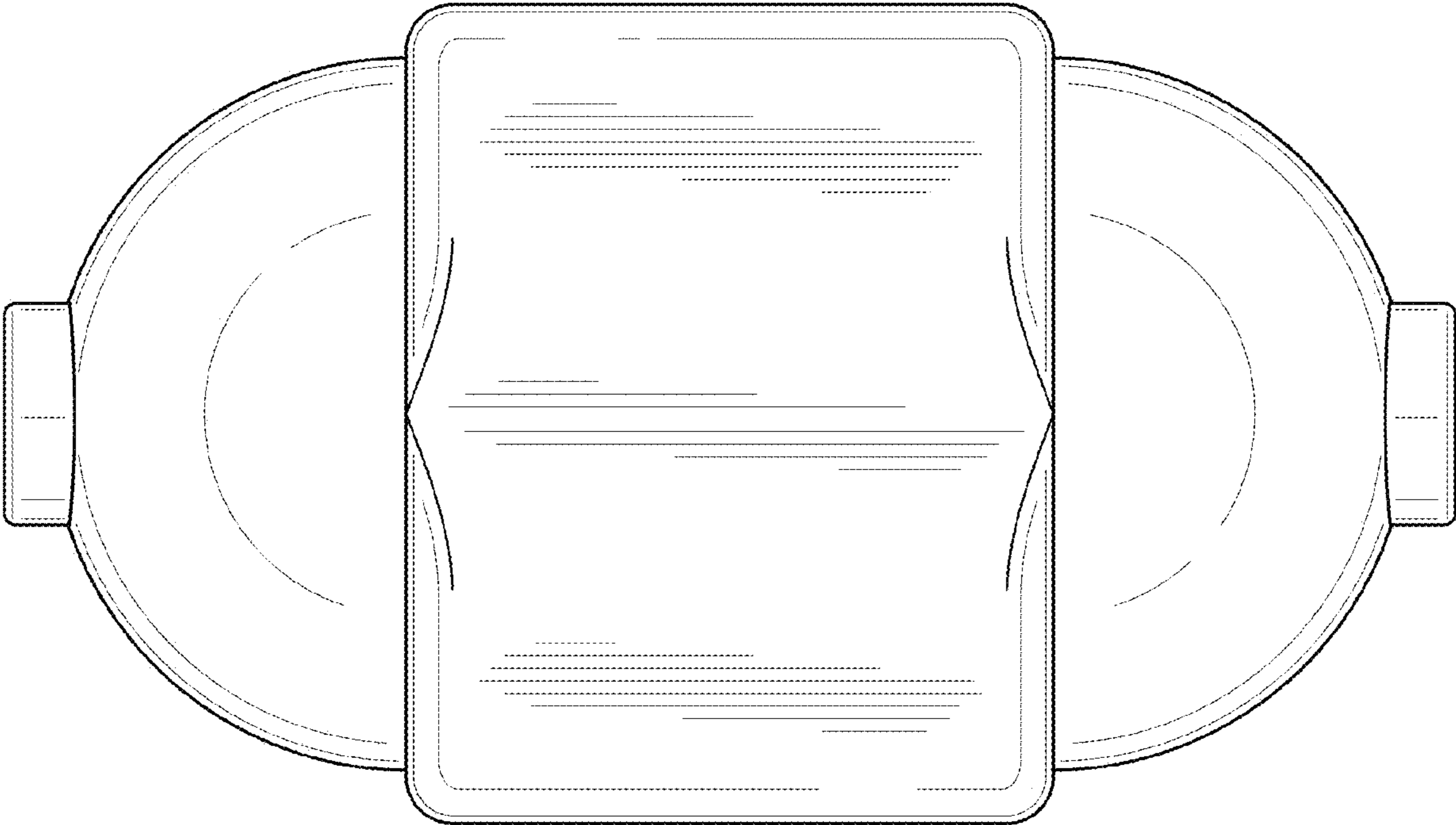

FIG. 11

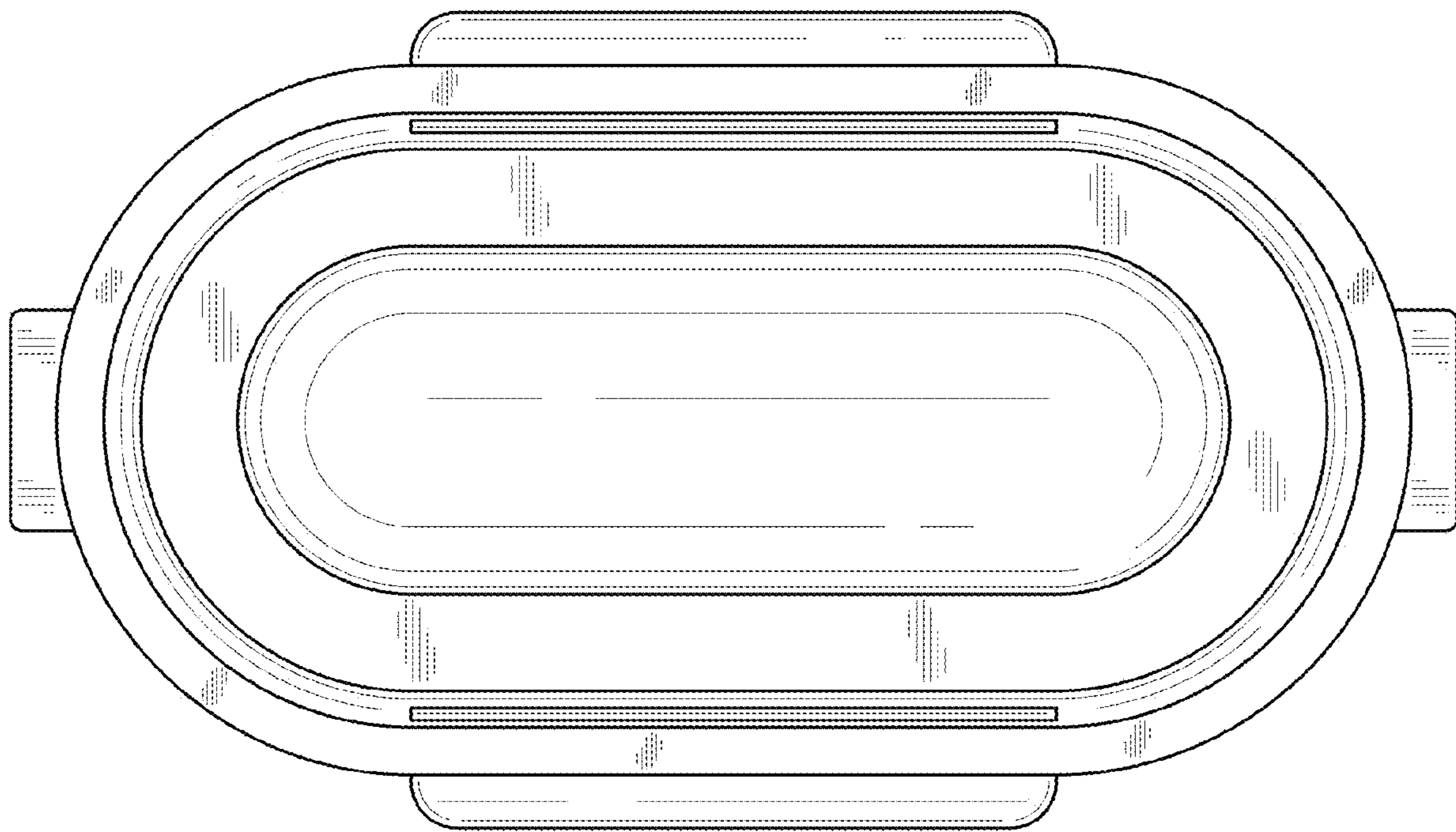

FIG. 12

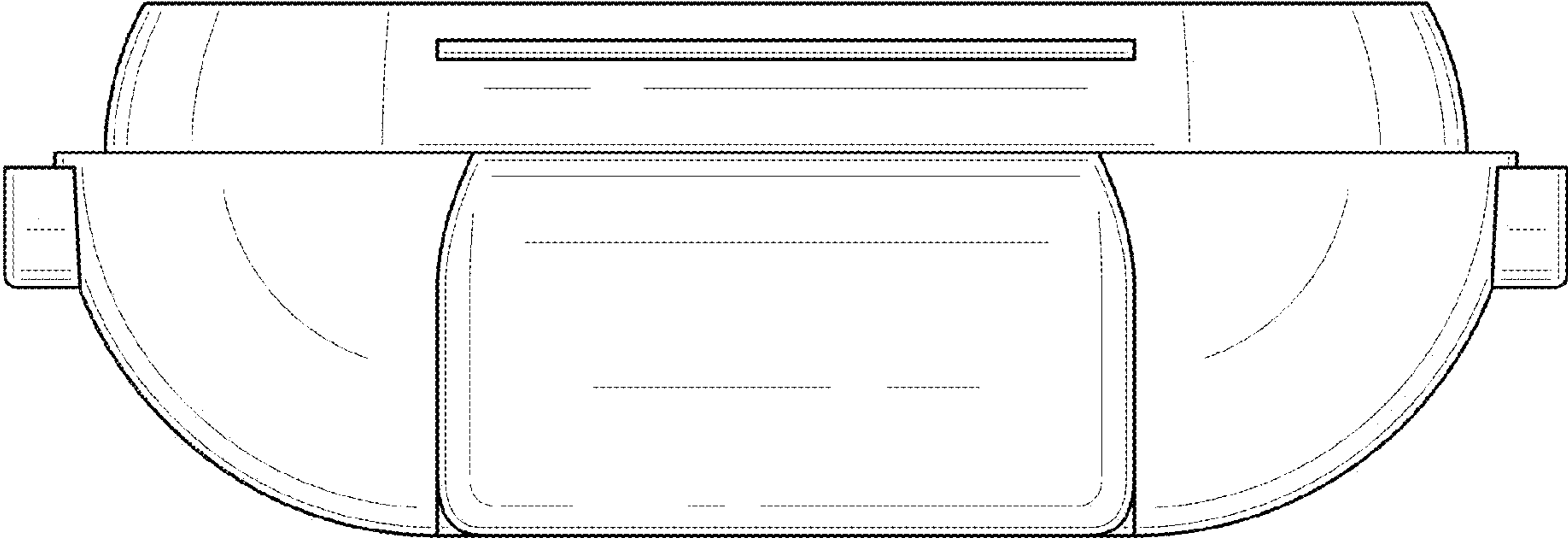

FIG. 13

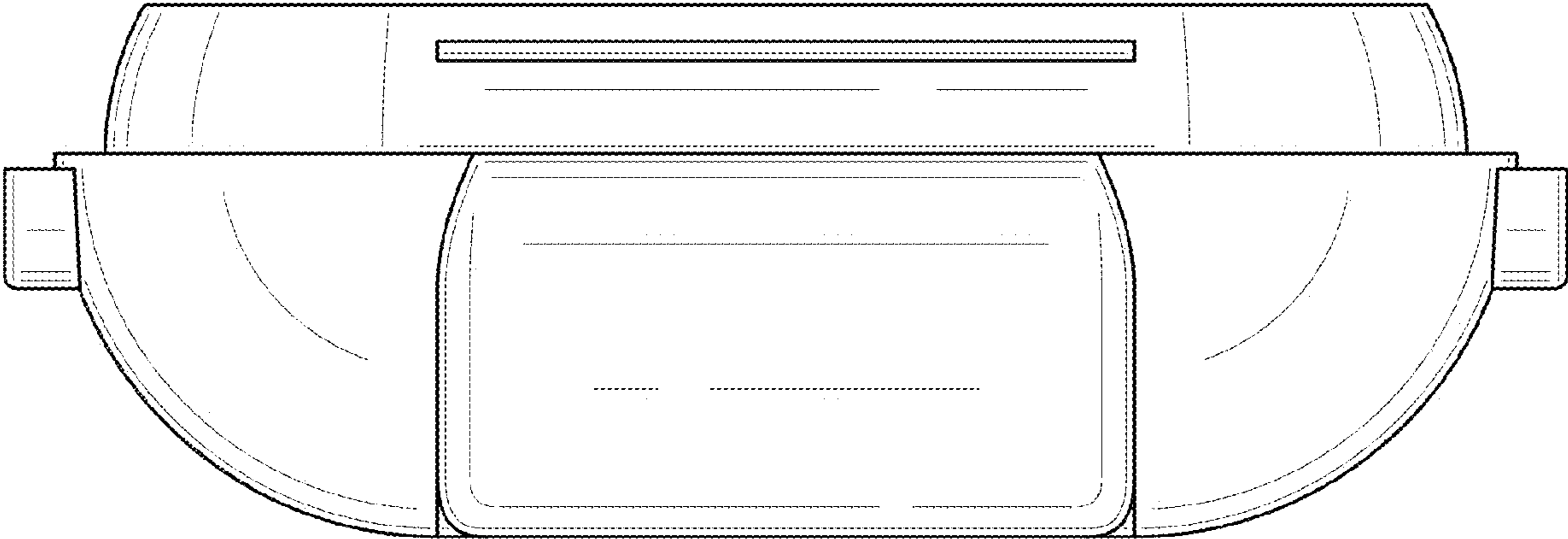

FIG. 14

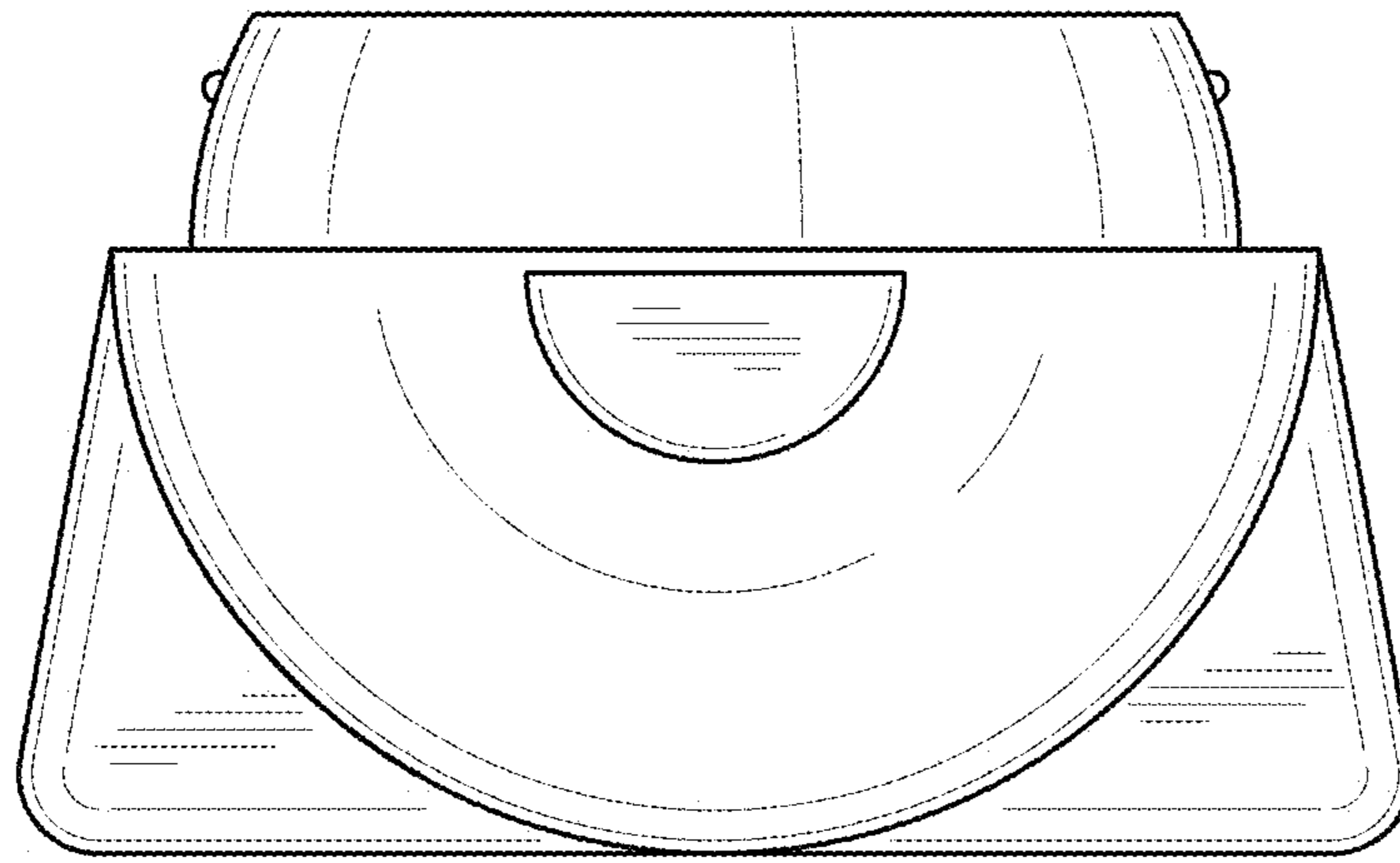

FIG. 15

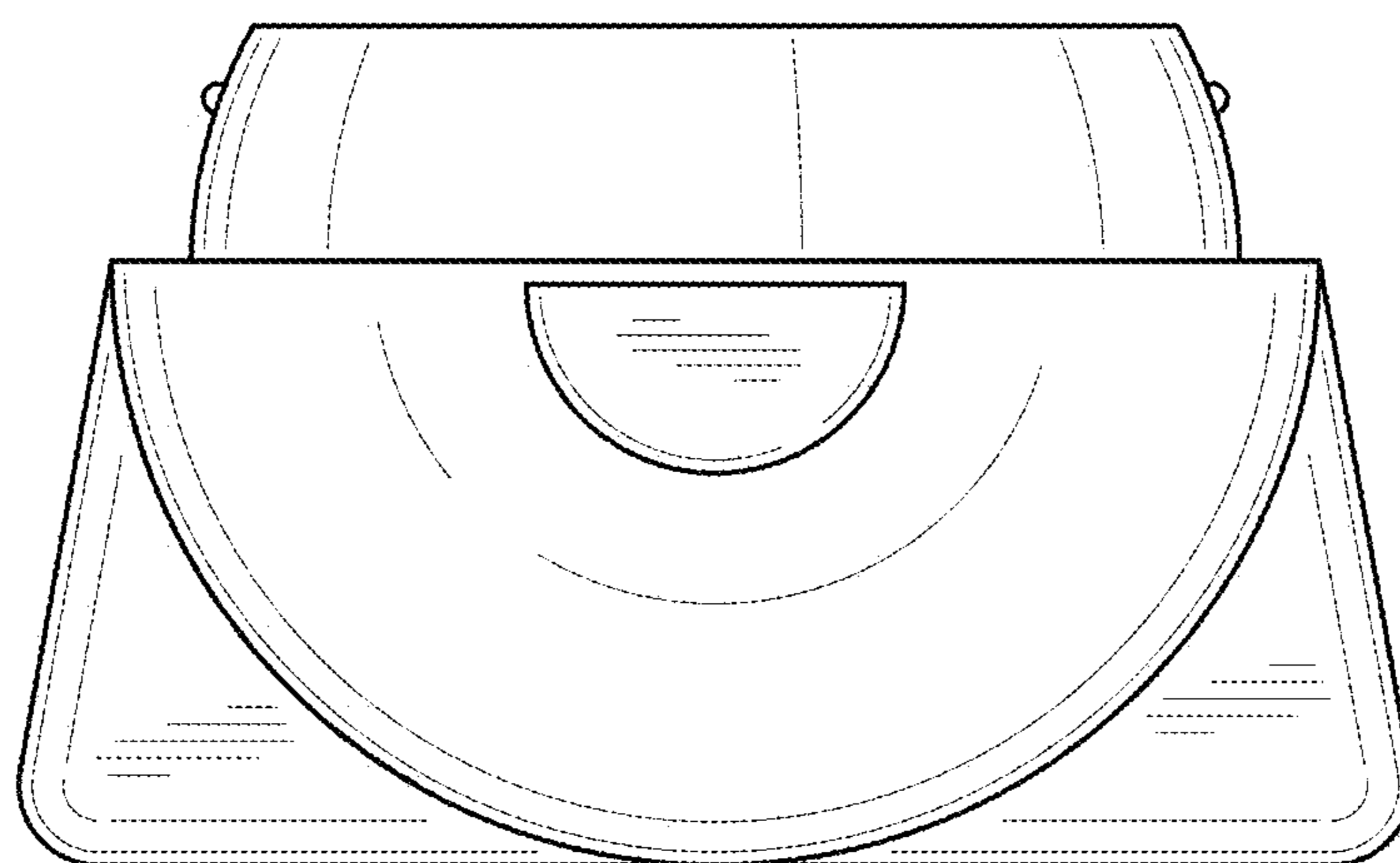

FIG. 16

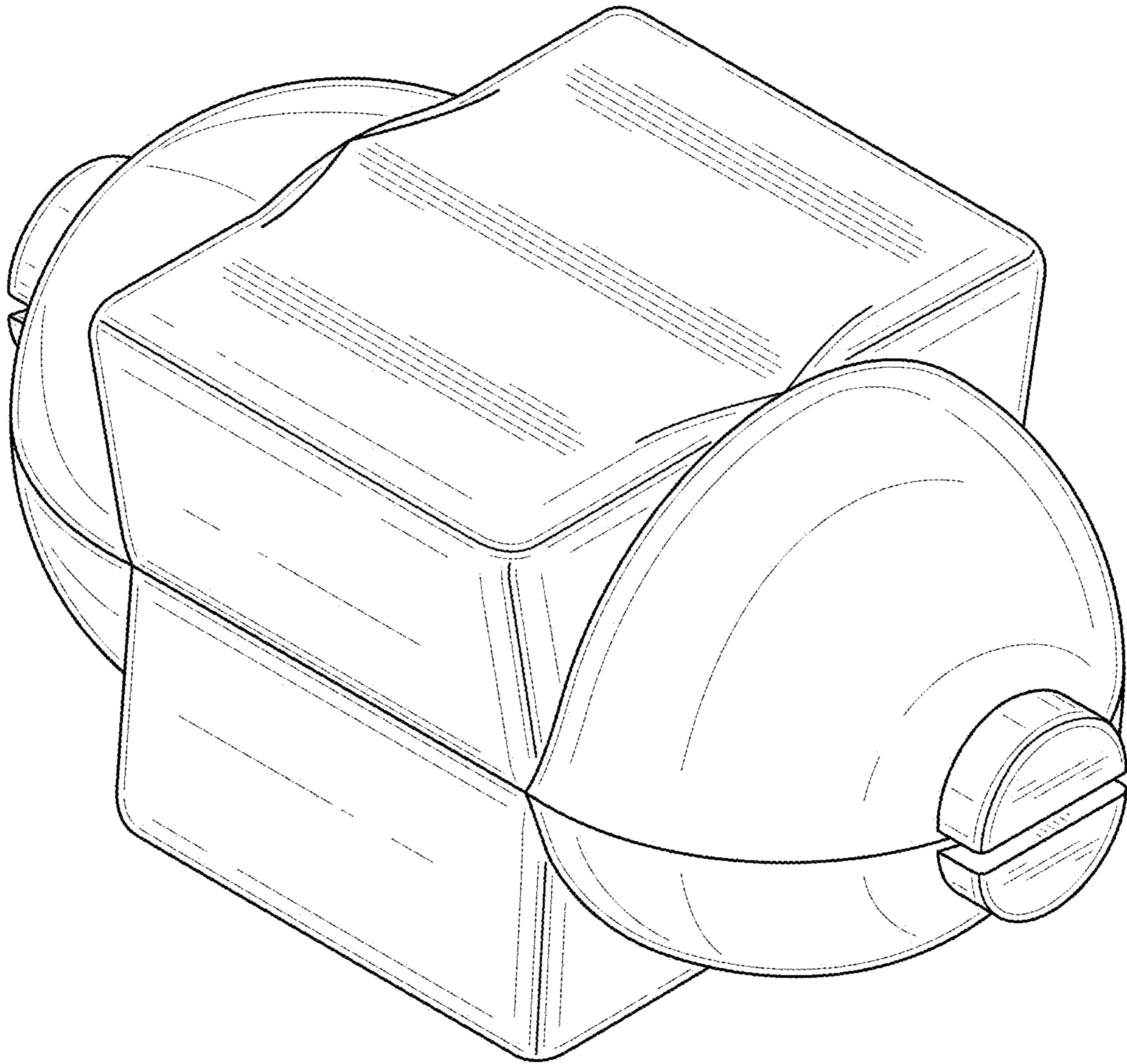

FIG. 17

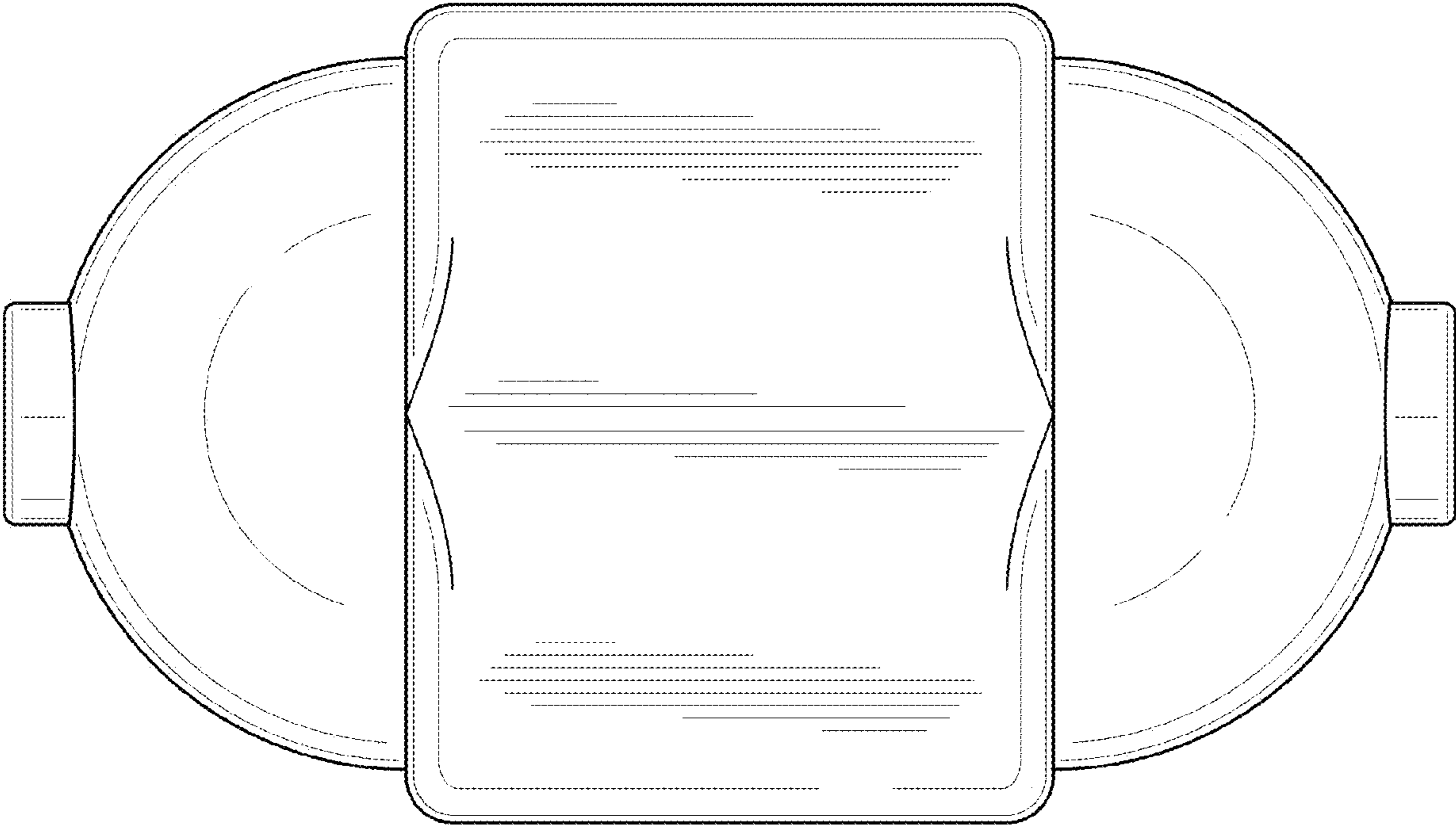

FIG. 18

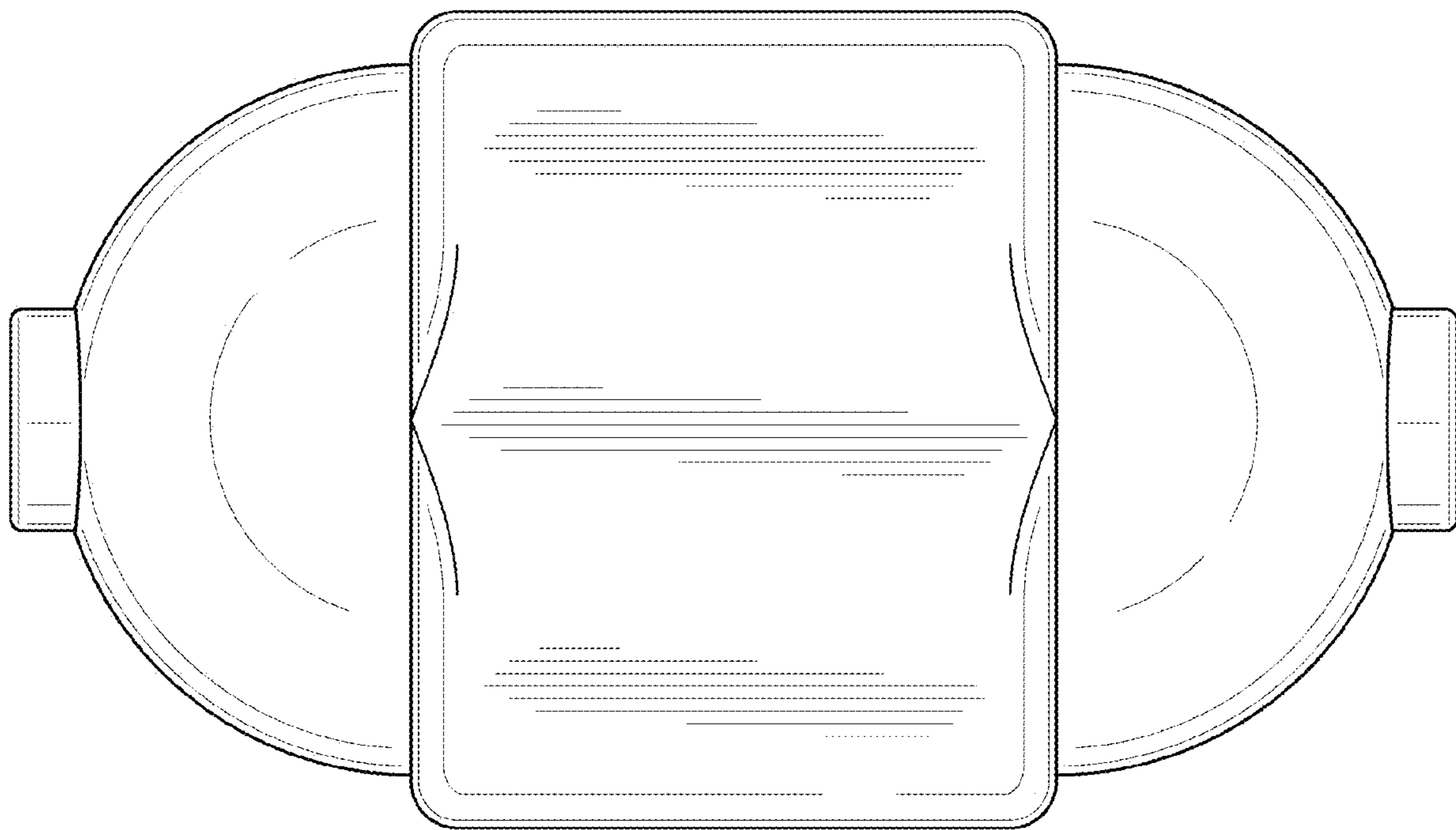

FIG. 19

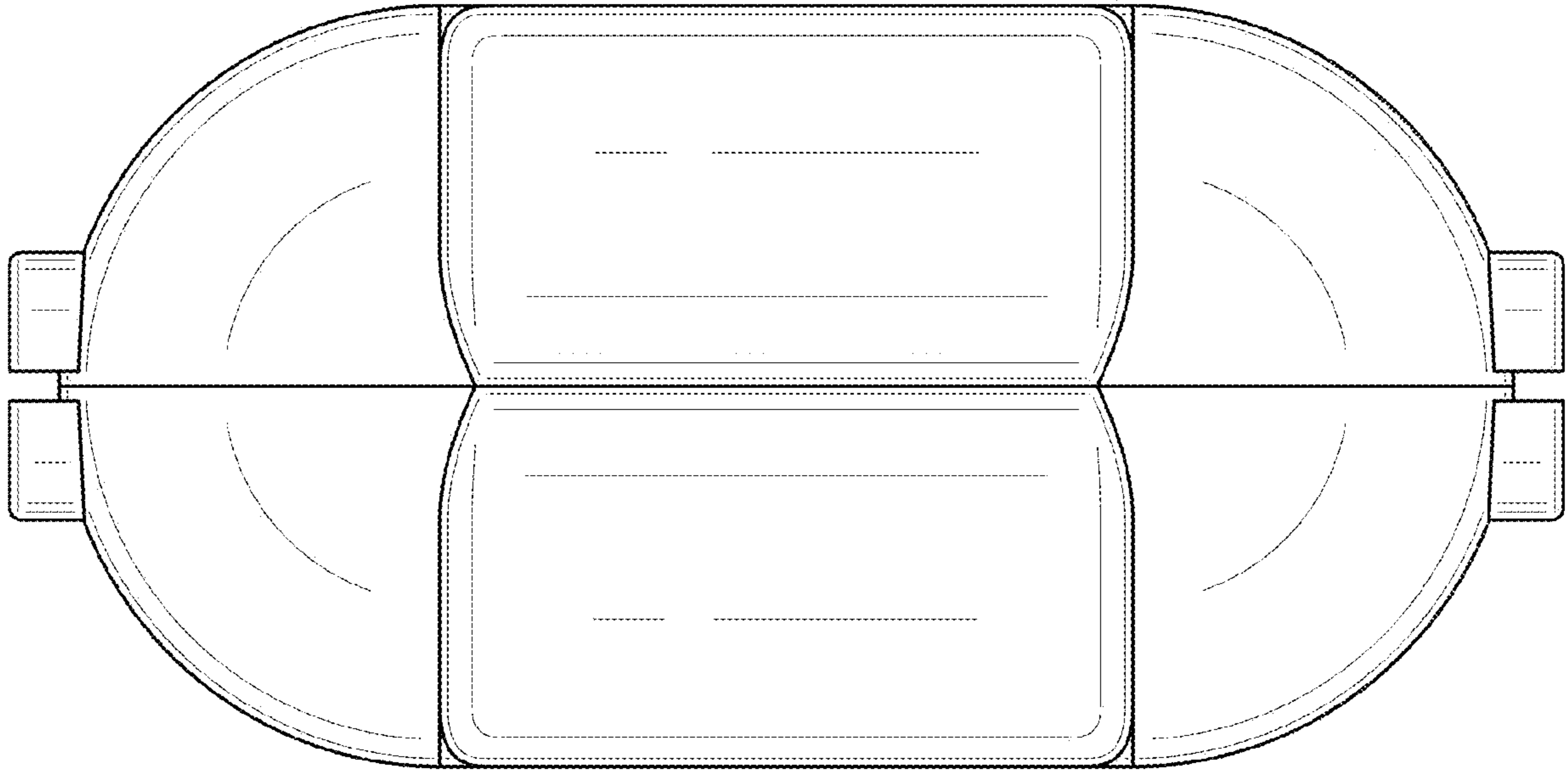

FIG. 20

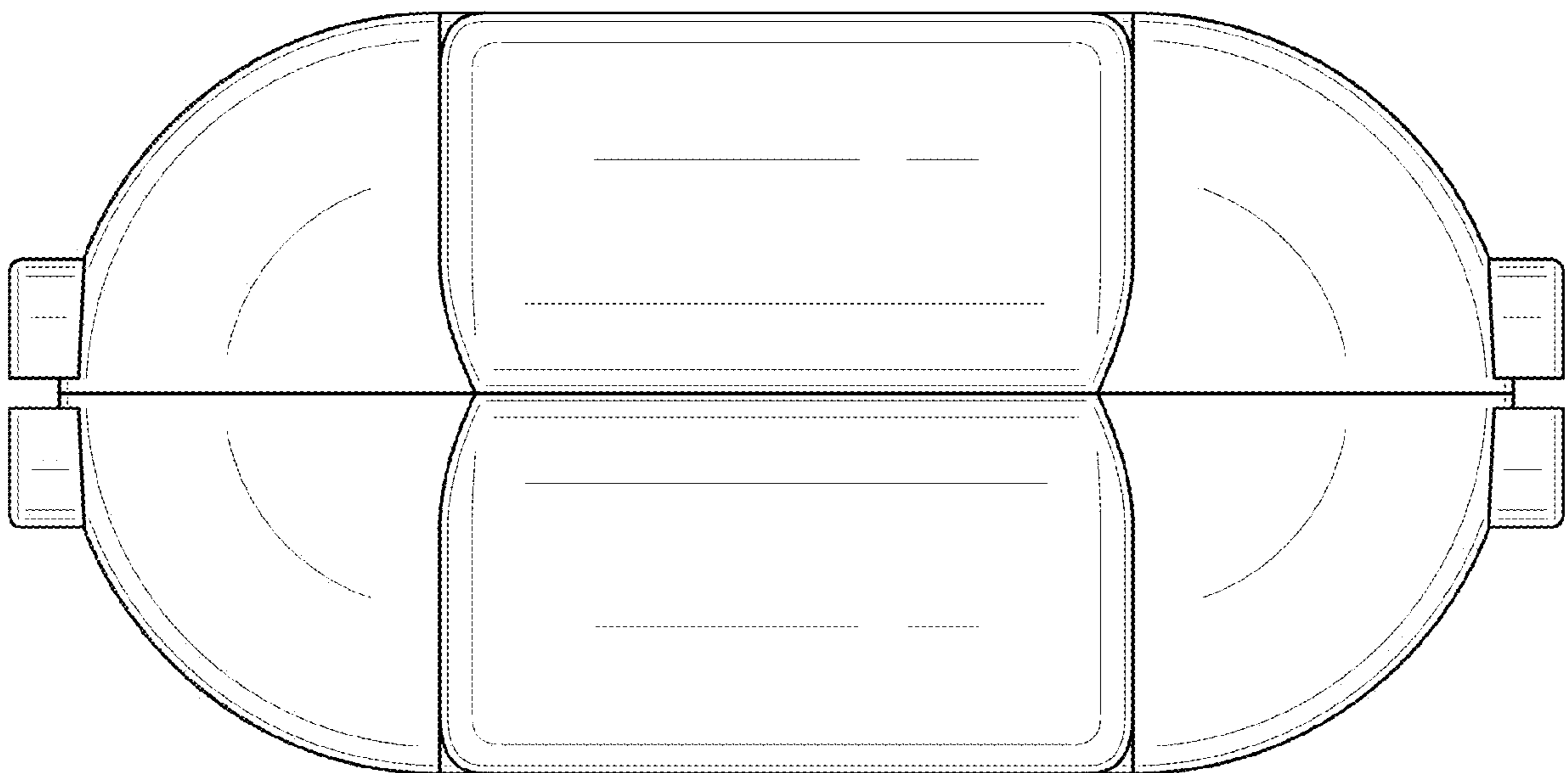

FIG. 21

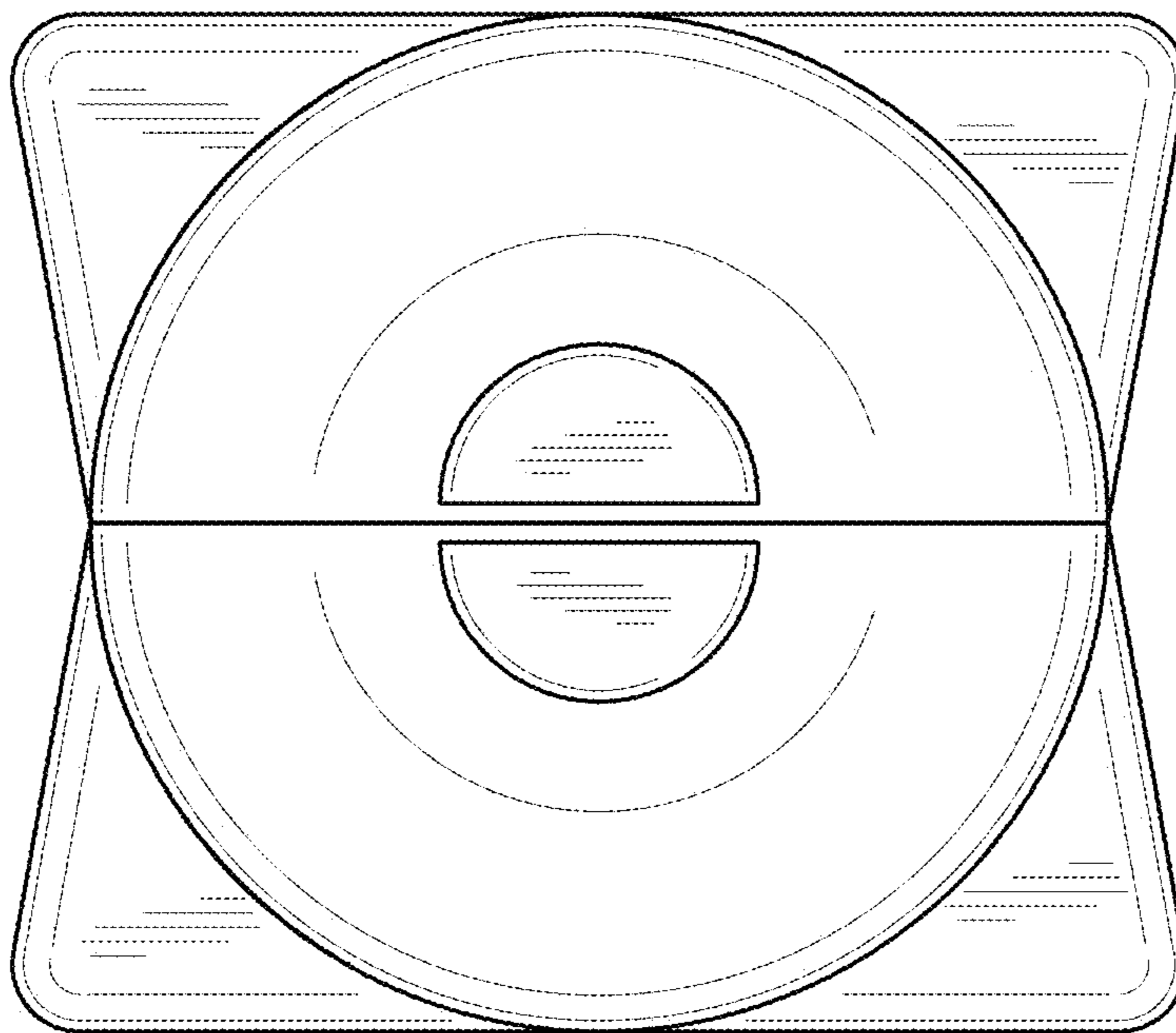

FIG. 22

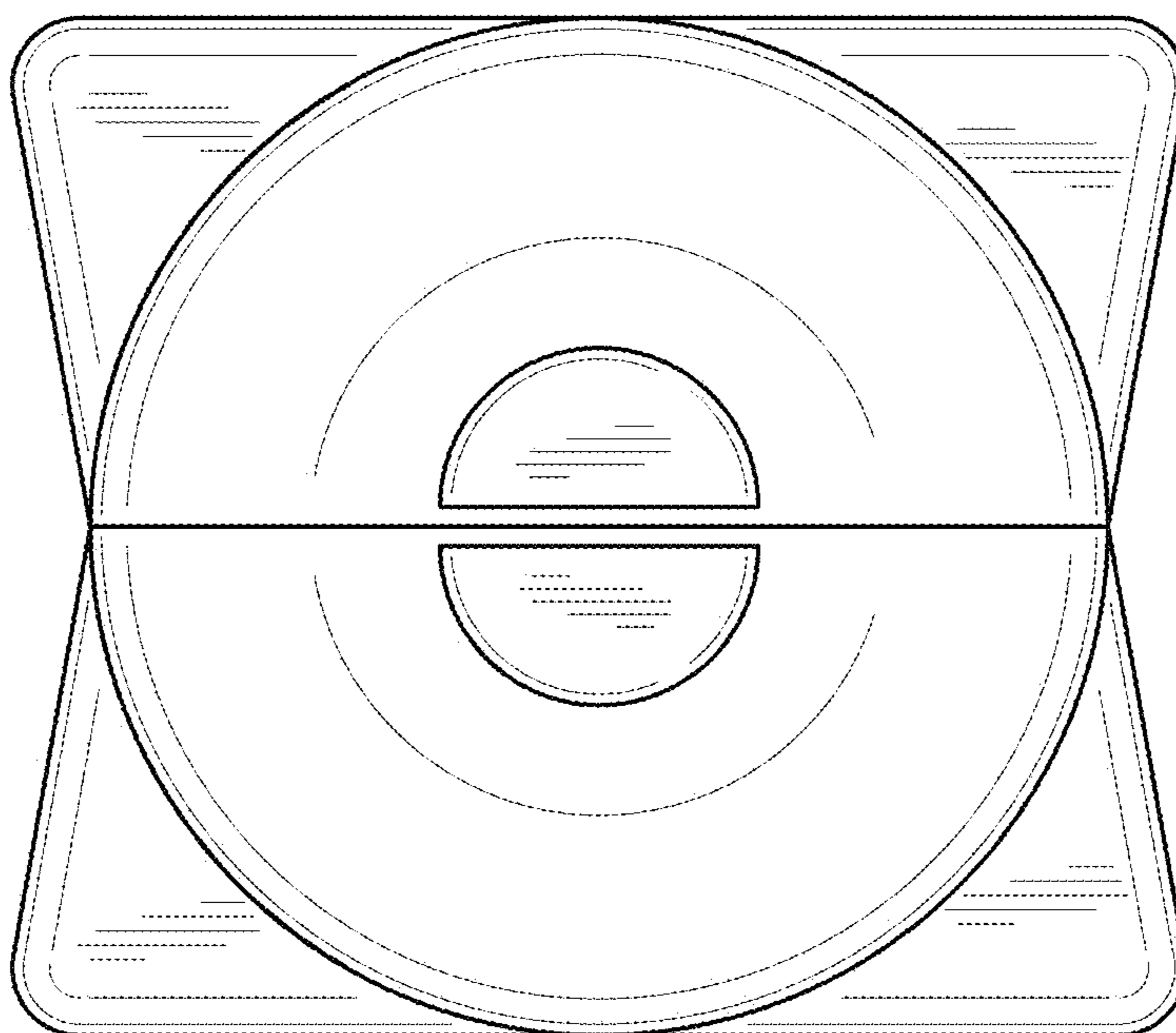

FIG. 23