



US00D921206S

(12) **United States Design Patent** (10) **Patent No.:** **US D921,206 S**  
**Borisov** (45) **Date of Patent:** **\*\* Jun. 1, 2021**

(54) **WINDOW DRESSING**  
(71) Applicant: **Medline Industries, Inc.**, Northfield, IL (US)

5,520,629 A 5/1996 Heinecke et al.  
5,531,855 A 7/1996 Heinecke et al.  
5,599,289 A 2/1997 Castellana  
(Continued)

(72) Inventor: **Arielle Borisov**, Buffalo Grove, IL (US)

FOREIGN PATENT DOCUMENTS

(73) Assignee: **Medline Industries, Inc.**, Northfield, IL (US)

WO 2013162680 A1 10/2013  
WO 2014003957 A1 1/2014  
WO 2016178974 A1 11/2016

(\*\*) Term: **15 Years**

OTHER PUBLICATIONS

(21) Appl. No.: **29/705,226**

Medline. VersaDerm 2000 Window Dressings. No date specified. <https://www.medline.com/product/VersaDerm-2000-Window-Dressings/Transparent-Film/Z05-PF190973?question=&index=P6&indexCount=6> (Year: 0).\*

(22) Filed: **Sep. 10, 2019**

(51) **LOC (13) Cl.** ..... **24-04**

(Continued)

(52) **U.S. Cl.**

USPC ..... **D24/189**

(58) **Field of Classification Search**

USPC ..... D24/188-192, 200, 206, 215, 130  
CPC ..... A61F 13/00; A61F 13/023; A61F 15/008;  
A61F 15/004; A61M 2025/0246; A61M 25/02;  
A61M 25/024; A61M 25/0266; A61M 25/0253

*Primary Examiner* — Darcey E Gottschalk

(74) *Attorney, Agent, or Firm* — Gurr Brande & Spendlove, PLLC.; Robert Dan Spendlove

See application file for complete search history.

(57)

**CLAIM**

The ornamental design for a window dressing, as shown and described.

(56) **References Cited**

U.S. PATENT DOCUMENTS

4,485,809 A 12/1984 Dellas  
4,499,896 A 2/1985 Heinecke  
4,598,004 A 7/1986 Heinecke  
4,600,001 A 7/1986 Gilman  
4,641,643 A 2/1987 Greer  
4,917,928 A 4/1990 Heinecke  
4,917,929 A 4/1990 Heinecke  
RE33,353 E 9/1990 Heinecke  
RE33,727 E 10/1991 Sims  
5,088,483 A 2/1992 Heinecke  
5,160,315 A 11/1992 Heinecke et al.  
5,183,664 A 2/1993 Ansell  
5,380,294 A 1/1995 Persson

**DESCRIPTION**

FIG. 1 is a perspective view of the top, front and right sides of a window dressing;  
FIG. 2 is a plan view of the top of the window dressing illustrated in FIG. 1;  
FIG. 3 is a plan view of the bottom of the window dressing illustrated in FIG. 1;  
FIG. 4 is an elevation view of the front of the window dressing illustrated in FIG. 1;  
FIG. 5 is an elevation view of the rear of the window dressing illustrated in FIG. 1;  
FIG. 6 is an elevation view of the right side of the window dressing illustrated in FIG. 1; and,  
FIG. 7 is an elevation view of the left side of the window dressing illustrated in FIG. 1.

**1 Claim, 3 Drawing Sheets**

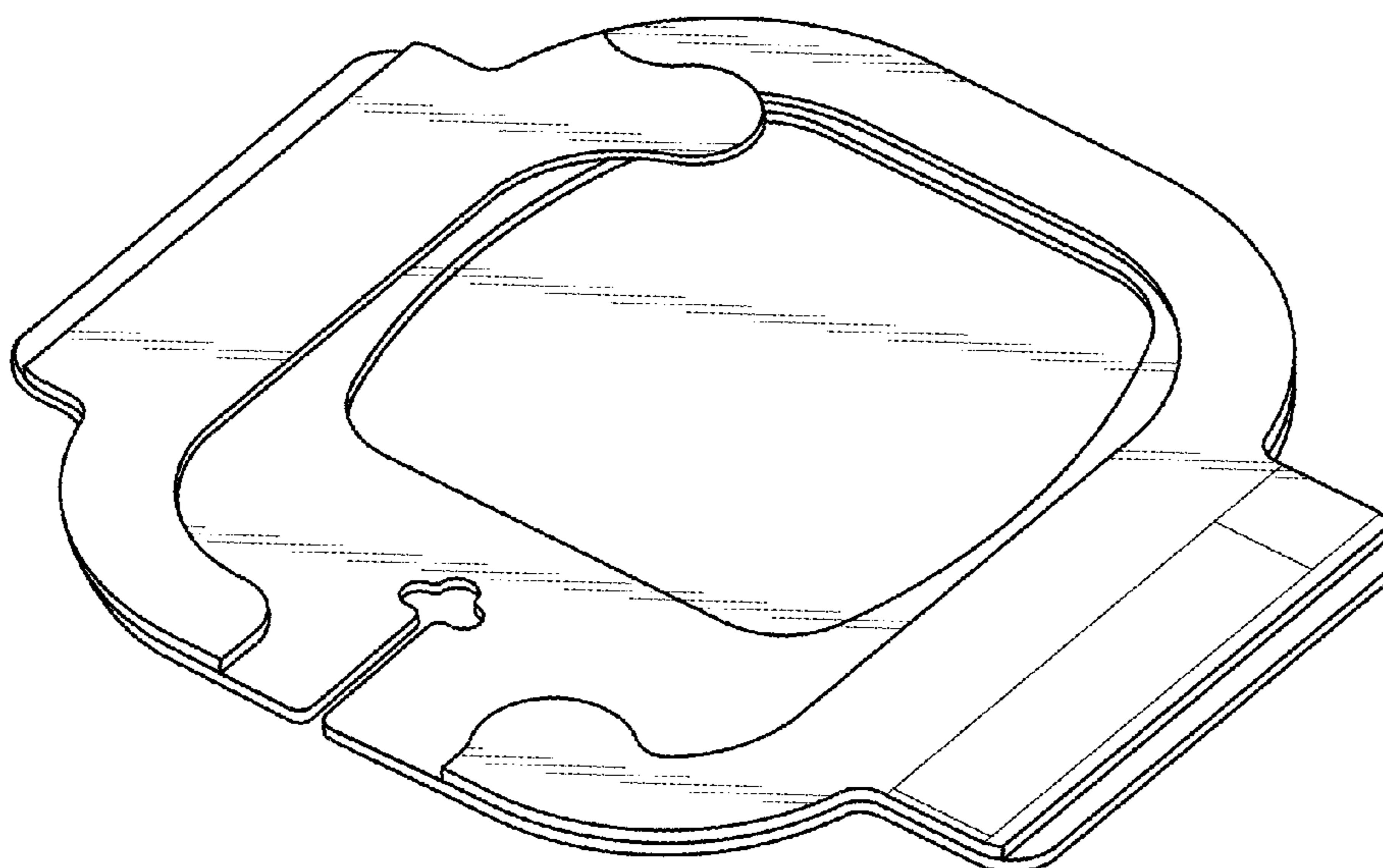

(56)

References Cited

U.S. PATENT DOCUMENTS

5,738,642 A 4/1998 Heinecke et al.  
 5,769,807 A 6/1998 Haddock et al.  
 5,849,325 A 12/1998 Heinecke et al.  
 5,885,254 A 3/1999 Matyas  
 D408,541 S 4/1999 Dunshee et al.  
 D409,754 S 5/1999 Dunshee et al.  
 5,968,000 A 10/1999 Harrison et al.  
 6,103,369 A 8/2000 Lucast et al.  
 D430,674 S 9/2000 Dunshee et al.  
 6,124,520 A 9/2000 Roberts  
 6,124,521 A 9/2000 Roberts  
 6,149,614 A 11/2000 Dunshee et al.  
 6,169,224 B1 1/2001 Heinecke et al.  
 6,187,126 B1 2/2001 Rothrum et al.  
 6,264,976 B1 7/2001 Heinecke et al.  
 D454,955 S 3/2002 Dunshee et al.  
 D457,240 S \* 5/2002 Islava ..... D24/130  
 6,420,622 B1 7/2002 Johnston et al.  
 6,436,432 B2 8/2002 Heinecke et al.  
 6,436,499 B1 8/2002 Krampe et al.  
 6,461,467 B2 10/2002 Blatchford et al.  
 6,547,229 B1 4/2003 Hanson et al.  
 6,607,799 B1 8/2003 Heinecke et al.  
 6,680,133 B2 1/2004 Sakawaki et al.  
 6,685,682 B1 2/2004 Peterson et al.  
 6,841,715 B2 1/2005 Roberts  
 6,867,342 B2 3/2005 Johnston et al.  
 6,927,315 B1 8/2005 Heinecke et al.  
 6,998,511 B2 2/2006 Worthley  
 7,025,749 B2 4/2006 Propp  
 7,090,660 B2 8/2006 Roberts et al.  
 7,232,427 B2 6/2007 Propp  
 7,294,751 B2 11/2007 Propp et al.  
 7,294,752 B1 11/2007 Propp  
 D572,824 S 7/2008 Propp  
 7,442,849 B2 10/2008 Heinecke  
 7,626,070 B2 12/2009 Propp  
 D612,504 S 3/2010 Ha et al.  
 7,674,948 B2 3/2010 Propp et al.  
 7,723,561 B2 5/2010 Propp  
 7,780,634 B2 8/2010 Propp  
 7,781,639 B2 8/2010 Johnston et al.  
 7,812,212 B2 10/2010 Propp et al.  
 D629,910 S 12/2010 Ha et al.  
 D629,911 S 12/2010 Ha et al.  
 D634,423 S 3/2011 Heinecke et al.  
 7,910,790 B2 3/2011 Johnston et al.  
 7,981,087 B2 7/2011 Gesler, III  
 8,049,057 B2 11/2011 Propp  
 8,049,058 B2 11/2011 Propp  
 8,053,623 B2 11/2011 Propp  
 8,053,624 B2 11/2011 Propp  
 8,110,710 B2 2/2012 Dai et al.  
 8,110,718 B2 2/2012 Heinecke  
 8,211,064 B2 7/2012 Sloan  
 8,212,101 B2 7/2012 Propp  
 8,372,051 B2 2/2013 Scholz et al.  
 D679,402 S 4/2013 Conrad-Vlasak et al.  
 D679,403 S 4/2013 Heinecke et al.  
 8,486,004 B1 7/2013 Propp  
 D687,555 S 8/2013 Peterson et al.  
 D688,377 S \* 8/2013 Heinecke ..... D24/189  
 D690,425 S 9/2013 Heinecke et al.  
 D695,901 S 12/2013 Heinecke et al.  
 8,968,253 B2 3/2015 Wallace et al.

9,168,180 B2 10/2015 Ha et al.  
 9,220,869 B2 12/2015 Propp  
 9,242,022 B2 1/2016 Asmus et al.  
 9,248,258 B2 2/2016 Roman et al.  
 9,457,123 B2 10/2016 Holm et al.  
 9,457,169 B2 10/2016 Peterson et al.  
 9,486,613 B2 11/2016 Dickert et al.  
 9,566,417 B1 2/2017 Propp  
 D790,714 S \* 6/2017 Addison ..... D24/189  
 D804,677 S \* 12/2017 Ramires ..... D24/189  
 D808,024 S \* 1/2018 Moore ..... D24/189  
 D808,025 S \* 1/2018 Moore ..... D24/189  
 D808,026 S \* 1/2018 Moore ..... D24/189  
 D834,201 S \* 11/2018 Heinecke ..... D24/189  
 D854,170 S \* 7/2019 Bergstrom ..... D24/189  
 D875,953 S \* 2/2020 Wang ..... D24/189  
 D895,813 S \* 9/2020 Hicken ..... D24/189  
 2010/0198161 A1 \* 8/2010 Propp ..... A61M 25/02  
 604/180  
 2013/0310754 A1 \* 11/2013 Kutsch ..... A61M 25/02  
 604/180  
 2014/0005607 A1 1/2014 Elsamahy et al.  
 2015/0086741 A1 3/2015 Karim et al.  
 2015/0141949 A1 5/2015 Decabooter et al.  
 2016/0015570 A1 1/2016 Heinecke et al.  
 2016/0030248 A1 2/2016 Potters  
 2016/0193452 A1 7/2016 Hanson et al.  
 2017/0073548 A1 3/2017 Karim et al.  
 2017/0232226 A1 8/2017 Loui et al.

OTHER PUBLICATIONS

Medline. SorbaView 2000 Window Dressings. No date specified.  
<https://www.medline.com/product/SorbaView-2000-Window-Dressings/Central-Line-Dressing-Trays/Z05-PF190971?question=&index=P6&indexCount=6> (Year: 0).\*

Iskus Health. Sorbaview Shield. 2017. <https://www.iskushealth.com/wp-content/uploads/2017/09/Sorbaview-SHIELD-Family-Brochure-IH-Leaflet-LGRS-Ref-5.4.2017.1.pdf> (Year: 2017).\*

3M, 3M Tegaderm and Tegaderm HP Transparent Dressings: The Clear Choice for Easy Application and Extended Wear Time, 2005.

3M, Tegaderm Transparent Film Dressings Product Profile, 2005, 2012, USA.

3M, 3M Tegaderm I.V. Advanced Securement Dressings Application and Removal Guide, 2011, Mar. 2014.

3M, Tegaderm I.V. Advanced Securement Dressings Product Information, 2011, 2014, USA.

Market Watch, 3M Announces Next Generation of Tegaderm I.V. Advanced Securement Dressings, Feb. 24, 2014.

3M, 3M Tegaderm Family of Transparent Film Dressings: Application and Removal Techniques, 2008.

3M, 3M Tegaderm™ I.V. Advanced Securement Dressing with Comfort Adhesive Technology, 2010.

3M, 3M Tegaderm™ IV Securement Dressing Designed for the BD Nexiva Closed IV Catheter System, 2006, 2013.

Centurion, Centurion Sorbaview Shield, 2011.

Centurion, Centurion Sorbaview Shield Peripheral Securement Solved, 2010.

Centurion, Centurion Sorbaview Shield With Adhesive Free Zone, 2010.

Notification of Transmittal of the International Search Report and the Written Opinion of the International Searching Authority, or the Declaration; International Patent Application No. PCT/US2018/053808; Medline Industries, Inc.; May 13, 2019.

\* cited by examiner

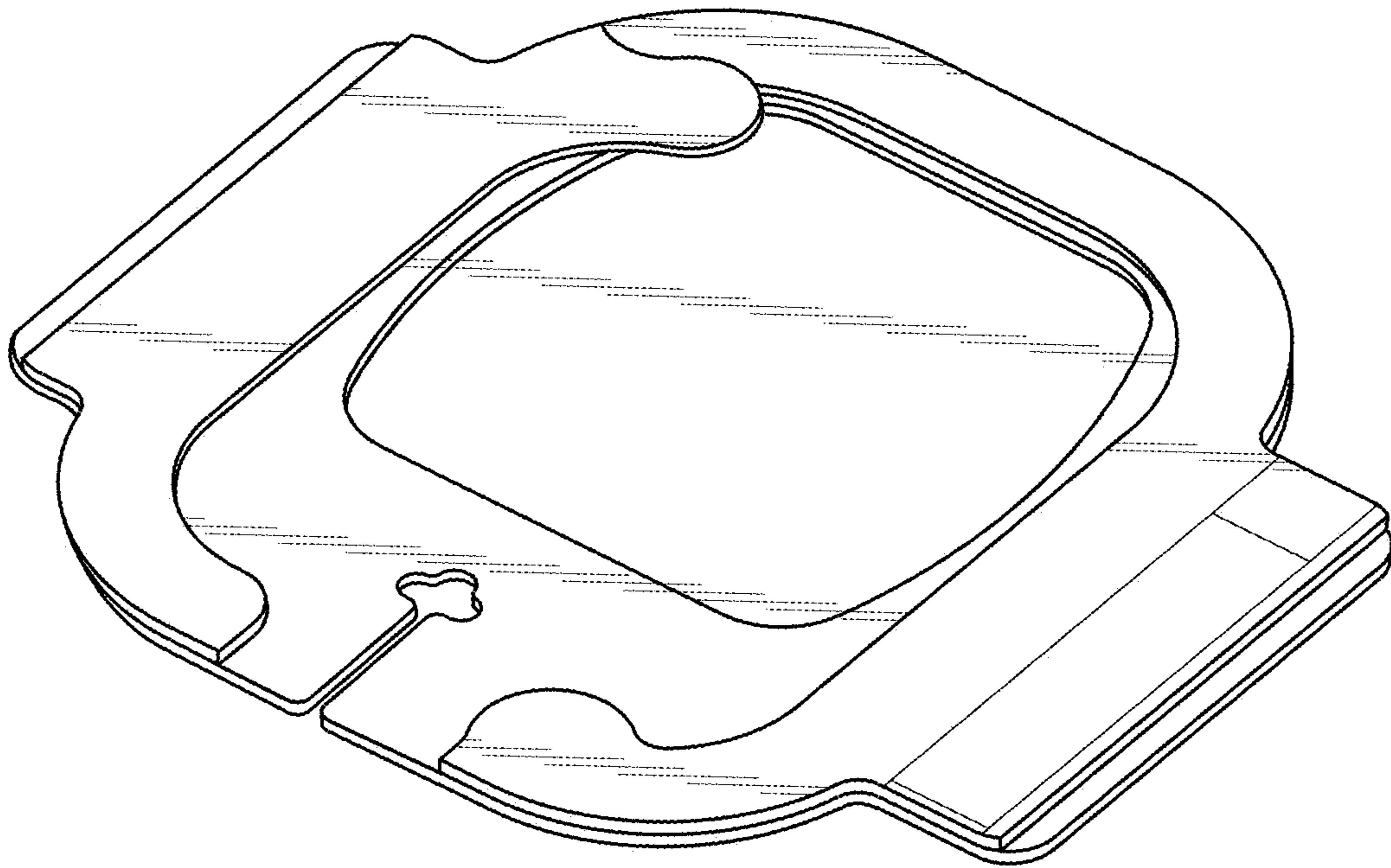

**Fig. 1**

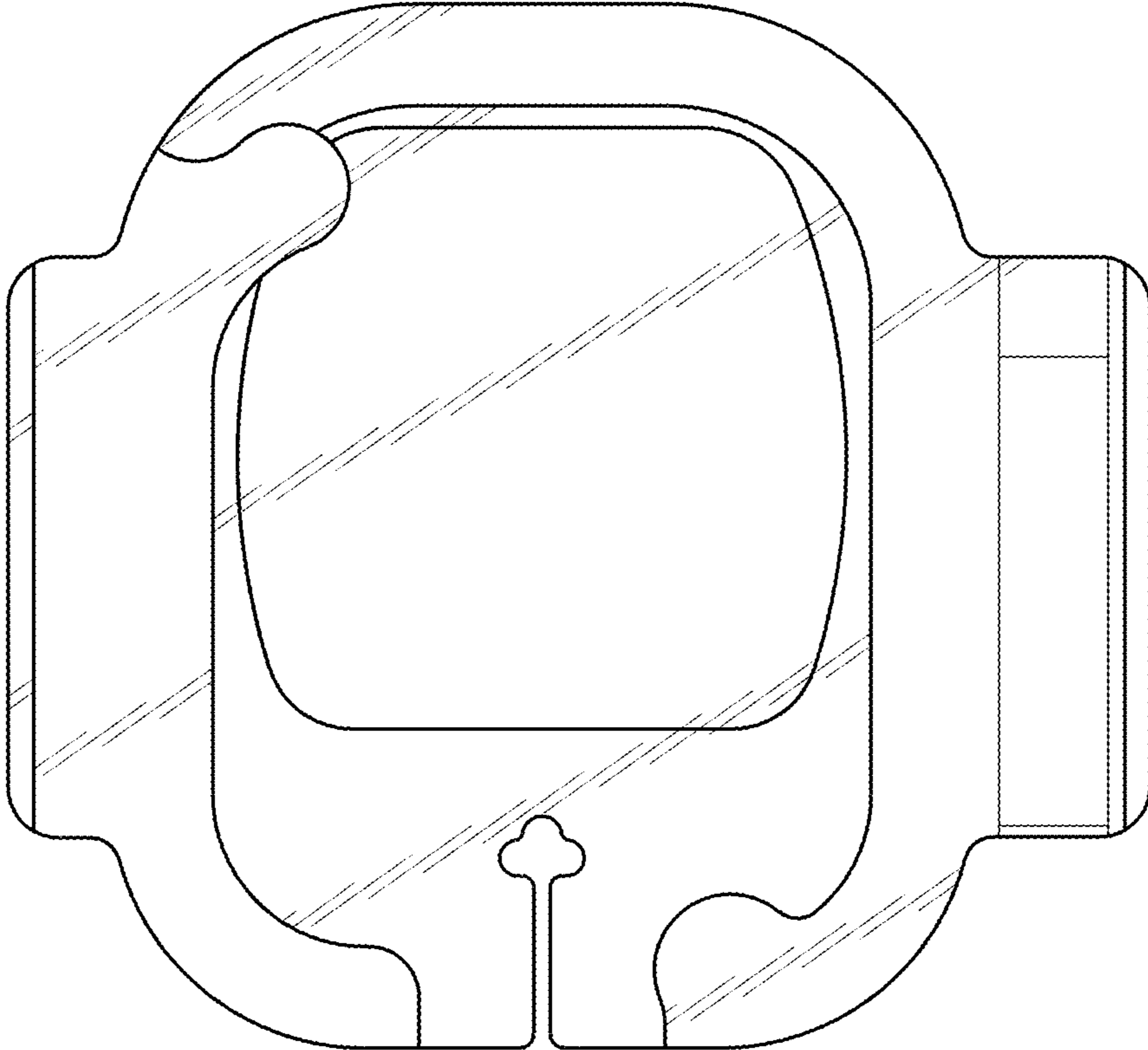

**Fig. 2**

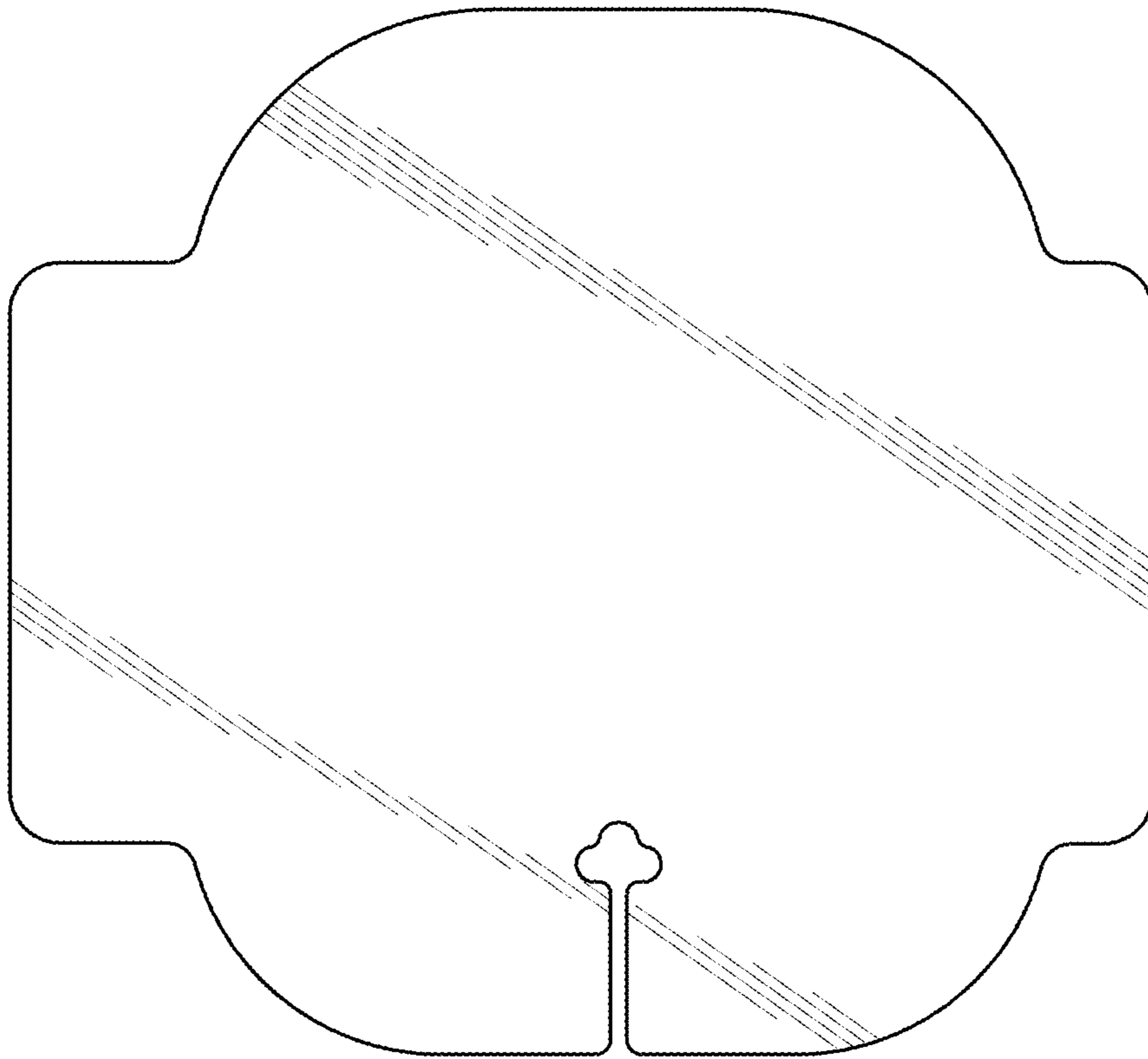

**Fig. 3**

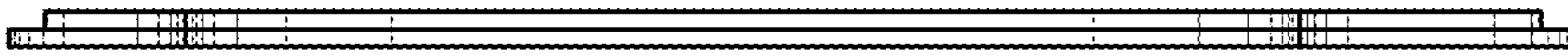

**Fig. 4**

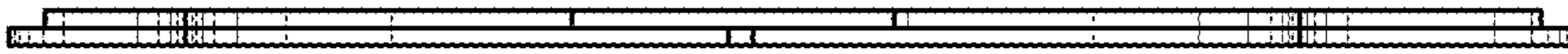

**Fig. 5**

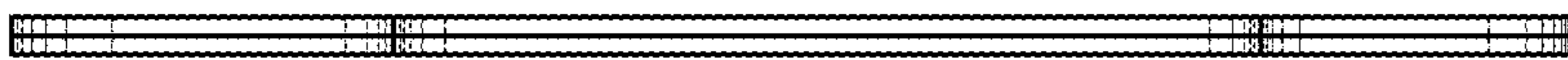

**Fig. 6**

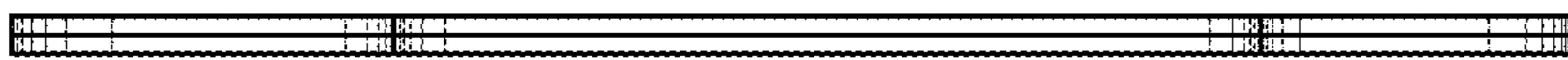

**Fig. 7**