



US00D921169S

(12) **United States Design Patent**
Cheng

(10) **Patent No.:** **US D921,169 S**
(45) **Date of Patent:** **** Jun. 1, 2021**

(54) **PROTECTOR FOR FLEXIBLE HOSE CONNECTORS**

(71) Applicant: **TOFORD PLASTIC MANUFACTURING CORP.**, Pingtung County (TW)

(72) Inventor: **Dave Cheng**, Donggang Township (TW)

(73) Assignee: **TOFORD PLASTIC MANUFACTURING CORP.**, Pingtung County (TW)

(**) Term: **15 Years**

(21) Appl. No.: **29/716,917**

(22) Filed: **Dec. 12, 2019**

(51) **LOC (13) Cl.** **23-01**

(52) **U.S. Cl.**
USPC **D23/266; D23/259**

(58) **Field of Classification Search**
USPC D23/259–262, 264–266, 213, 233, 235, D23/249; 137/551–552; 251/331, 366; 285/91, 345, 377, 388, 390, 16, 45, 285/148.22, 148.26, 244, 189, 33, 347, 285/417–418, 921; D24/112, 127, 129; D8/382, 394–396; 138/39, 96 R, 138/109–110, 118
CPC F16L 25/065; F16L 11/00; F16L 37/082; F16L 39/02; F16L 37/0915; F16L 21/06
See application file for complete search history.

(56) **References Cited**

U.S. PATENT DOCUMENTS

D98,259 S * 1/1936 Kramer D23/229
D500,475 S * 1/2005 Noro D13/133

D532,277 S * 11/2006 Shih D8/107
D567,339 S * 4/2008 Tiberghien D23/262
D567,340 S * 4/2008 Tiberghien D23/262
D583,915 S * 12/2008 Tiberghien D23/263
D616,969 S * 6/2010 Zore D23/262
D624,161 S * 9/2010 Zore D23/262
D718,846 S * 12/2014 Koskie D23/262
D719,646 S * 12/2014 Melo D23/266
D719,647 S * 12/2014 Melo D23/266
D898,881 S * 10/2020 Chapman D23/266
2017/0198844 A1 * 7/2017 Papafagos F16B 7/0413

* cited by examiner

Primary Examiner — Amy C Wierenga

(74) *Attorney, Agent, or Firm* — Leong C. Lei

(57) **CLAIM**

The ornamental design for a protector for flexible hose connectors, as shown and described.

DESCRIPTION

FIG. 1 is a perspective view of a protector for flexible hose connectors showing our new design; FIG. 2 is another perspective view thereof; FIG. 3 is a front elevational view thereof; FIG. 4 is a rear elevational view thereof; FIG. 5 is a left side elevational view thereof; FIG. 6 is a right side elevational view thereof; FIG. 7 is top plan view thereof; and, FIG. 8 is a bottom plan view thereof. The portions shown in broken lines form no part of the claimed design.

1 Claim, 7 Drawing Sheets

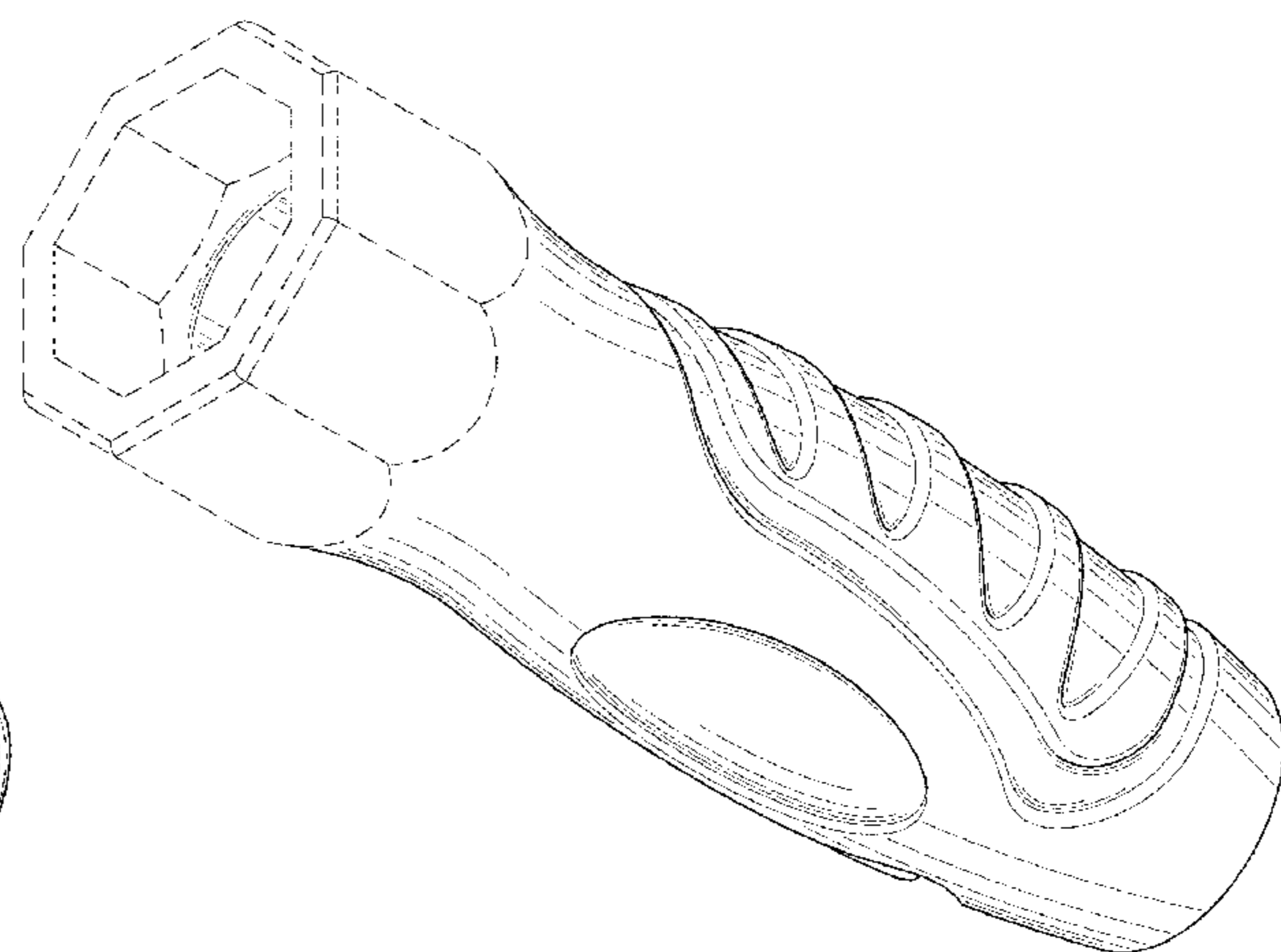
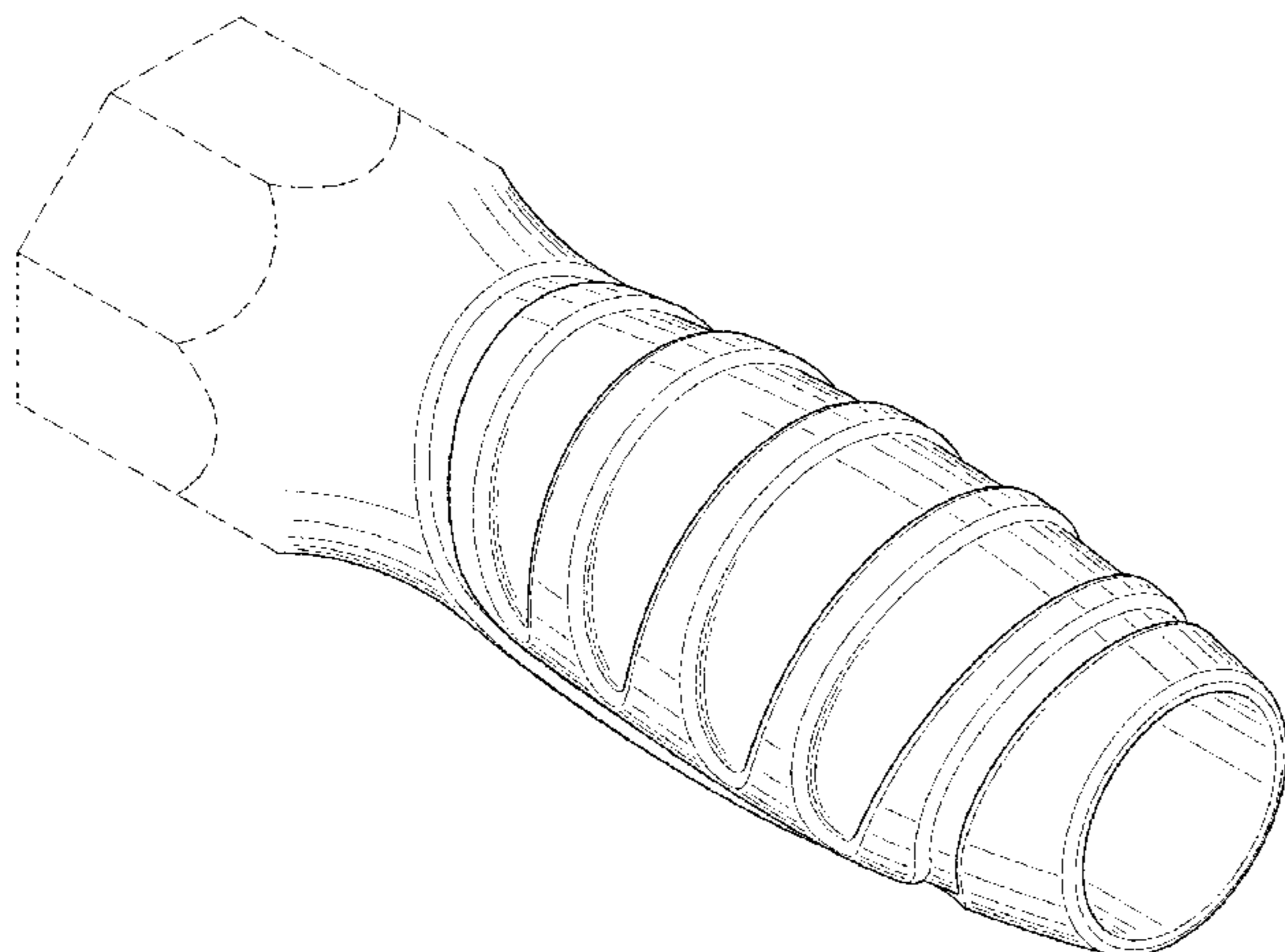

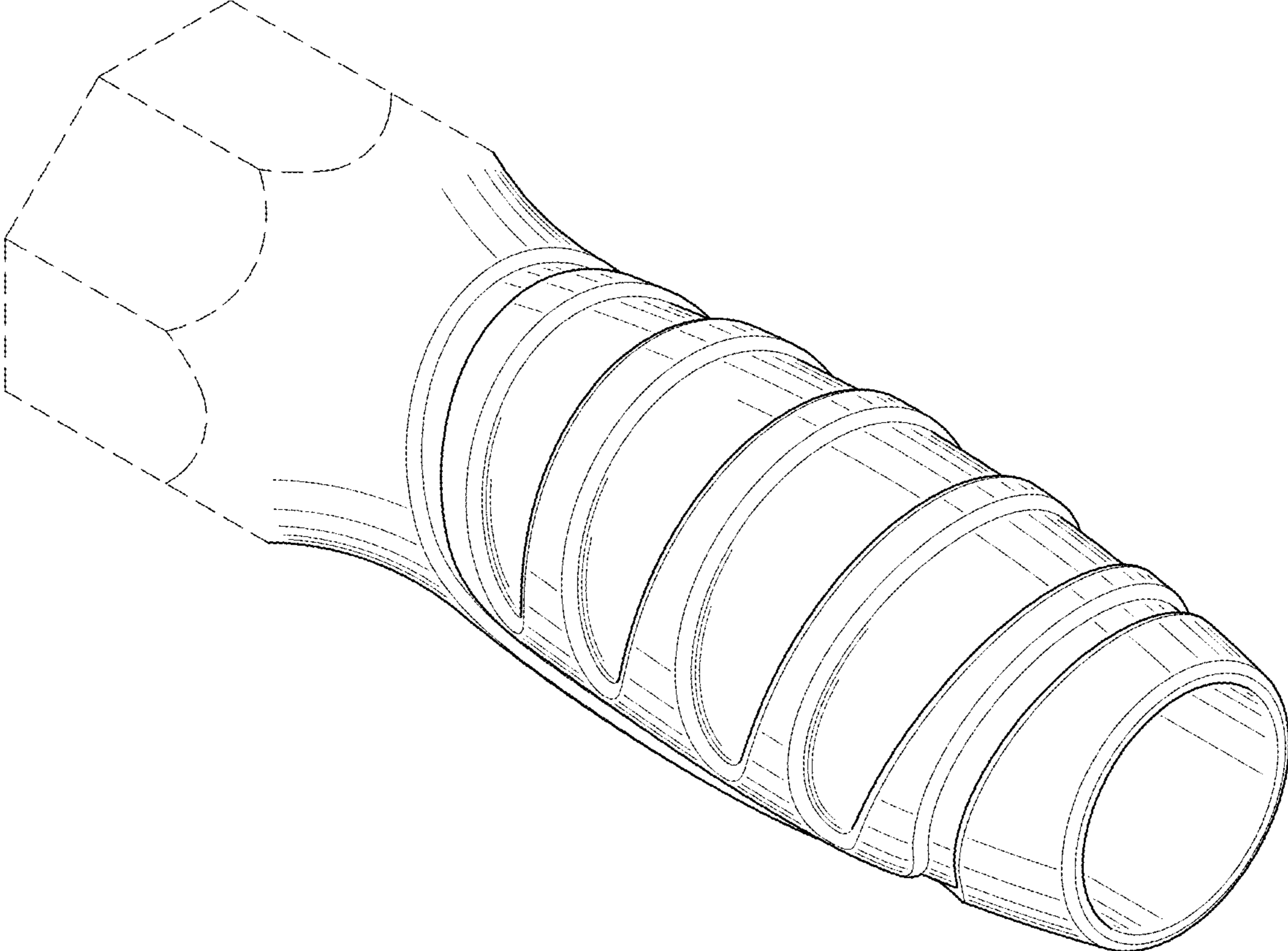

FIG. 1

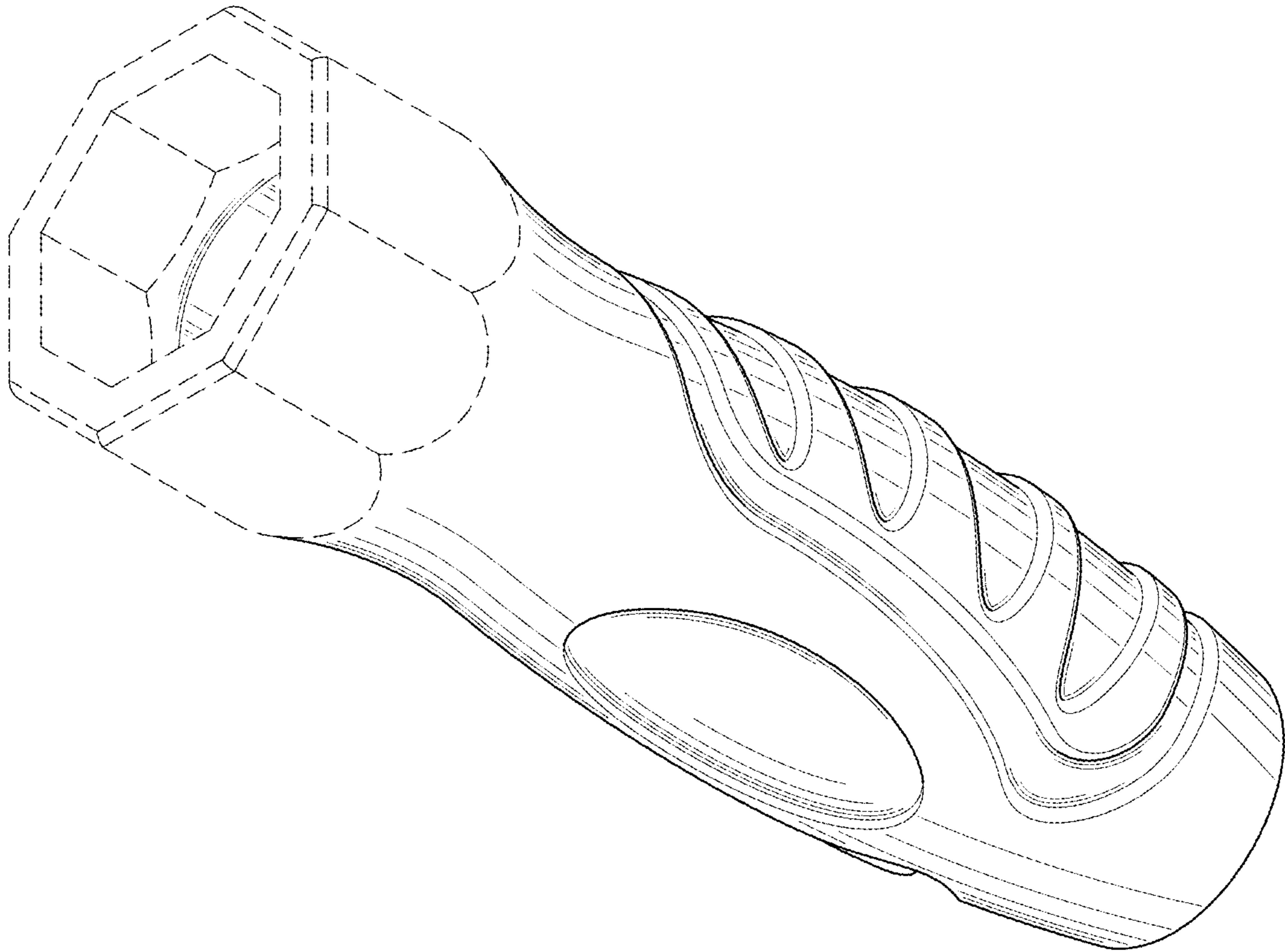

FIG. 2

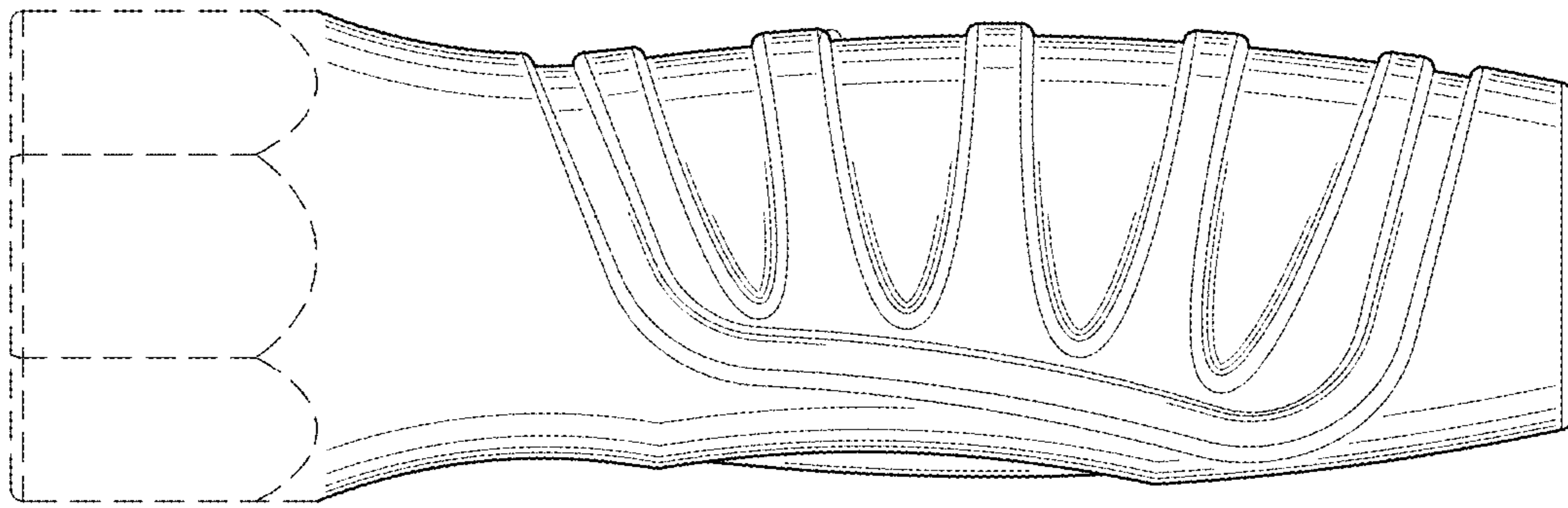

FIG. 3

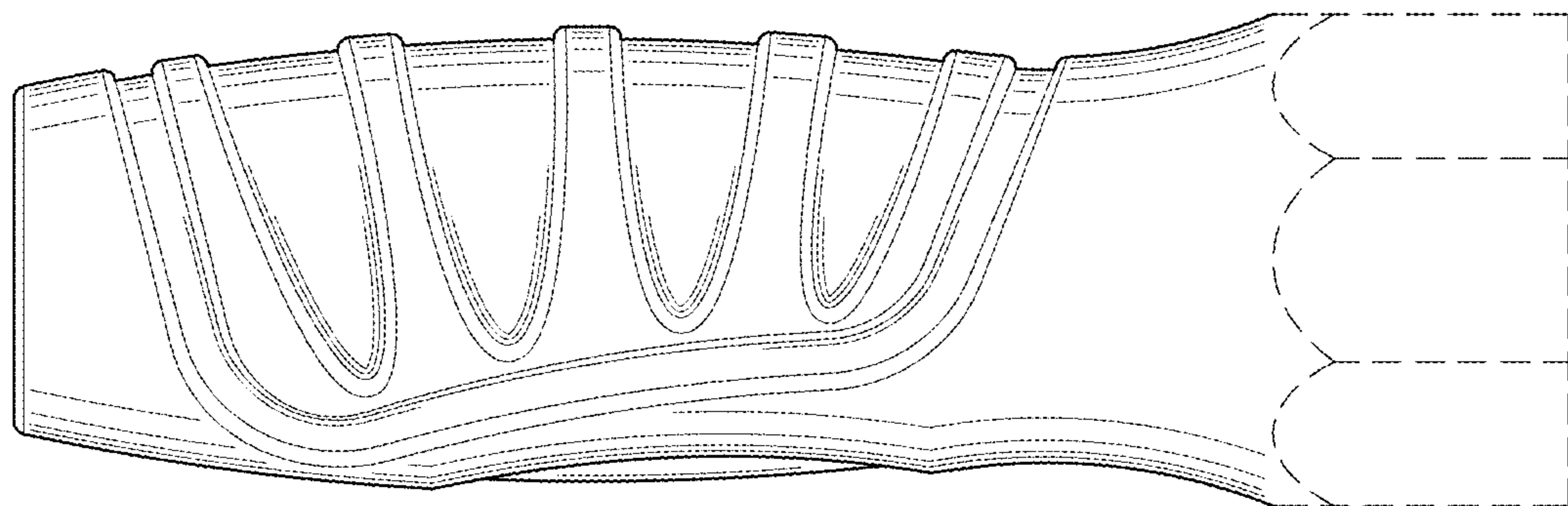

FIG. 4

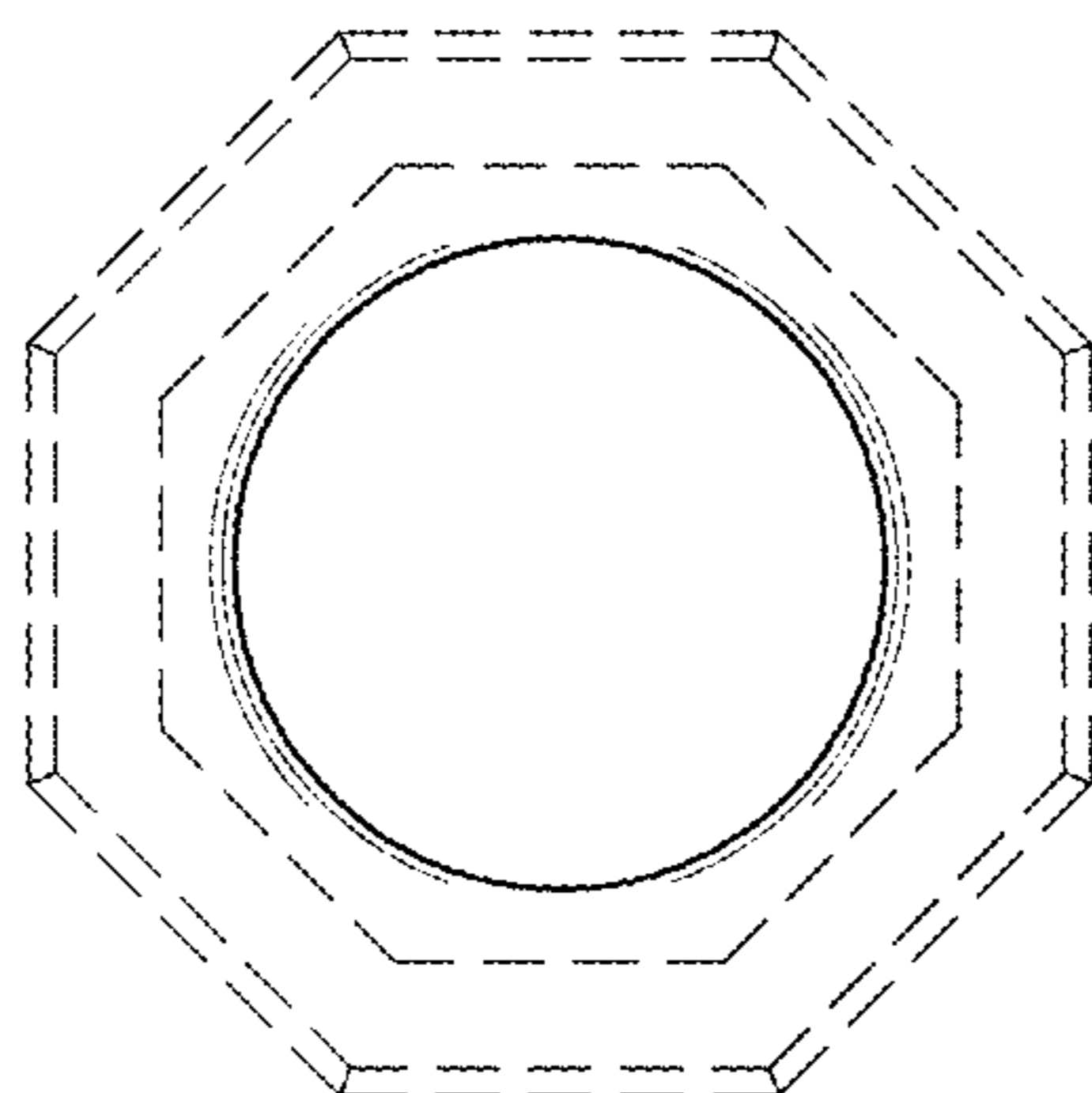

FIG. 5

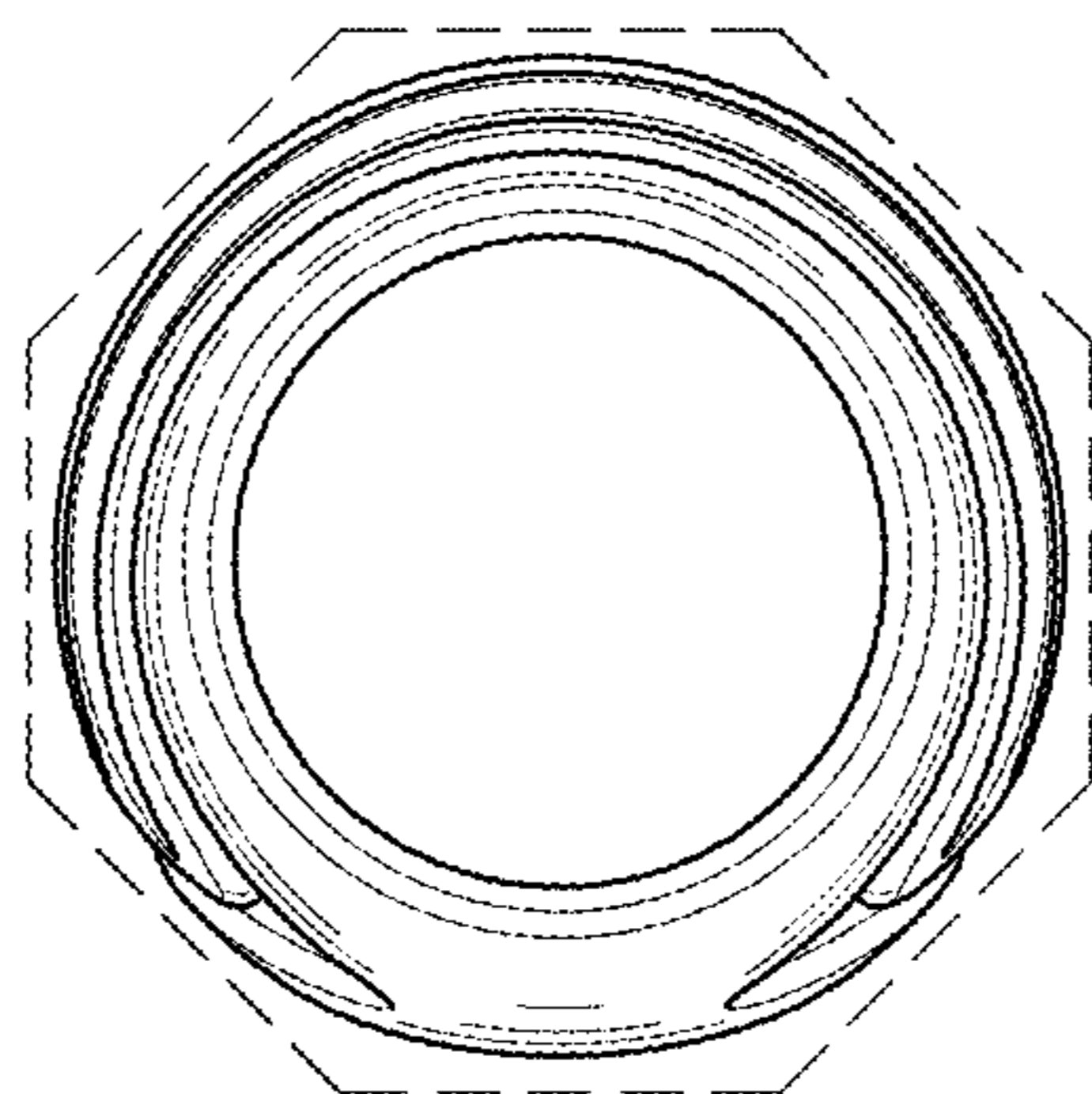

FIG. 6

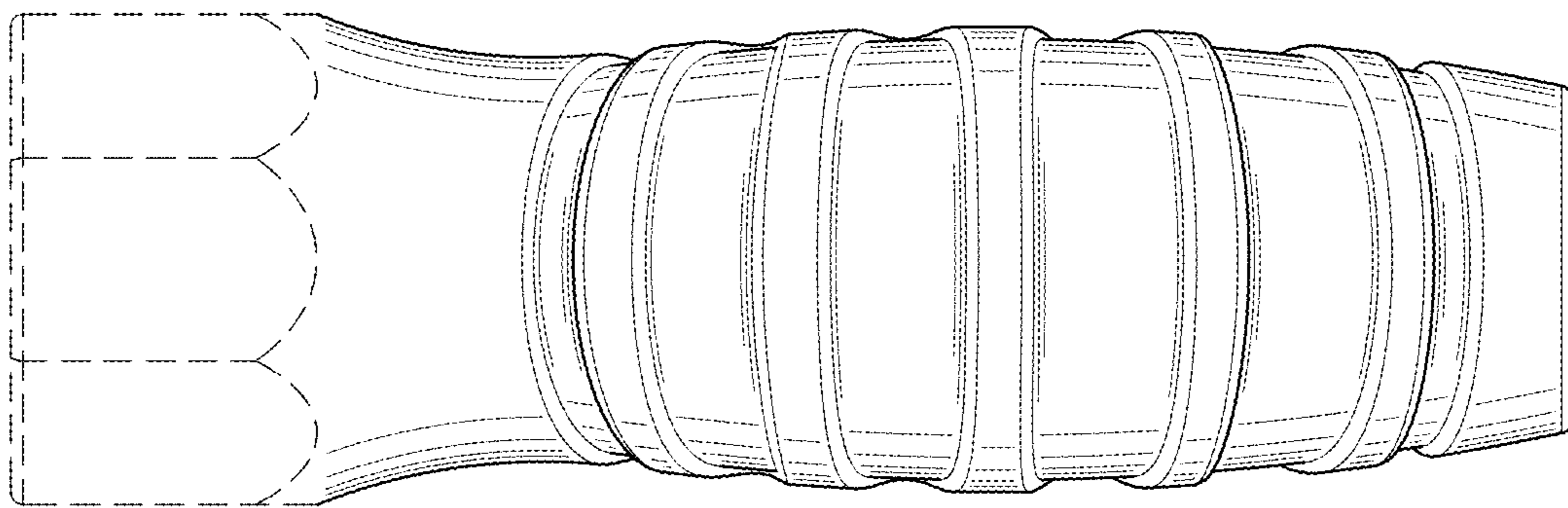

FIG. 7

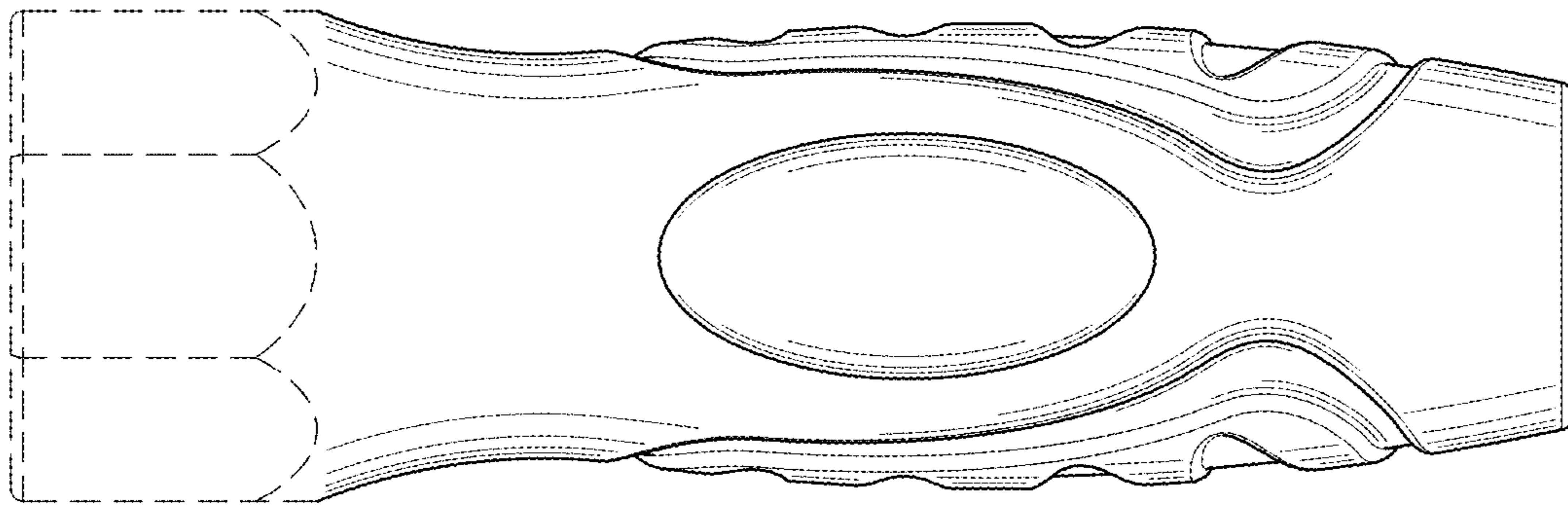

FIG. 8