



US00D921139S

(12) **United States Design Patent**  
**Wang et al.**

(10) **Patent No.:** **US D921,139 S**  
(45) **Date of Patent:** **\*\* Jun. 1, 2021**

- (54) **INFLATABLE WATERSLIDE**
- (71) Applicant: **SHENZHEN BESTWO E-COMMERCE CO., LTD**, Shenzhen (CN)
- (72) Inventors: **Shujie Wang**, Shenzhen (CN); **Zhijie Wang**, Shenzhen (CN)
- (73) Assignee: **SHENZHEN BESTWO E-COMMERCE CO., LTD**, Shenzhen (CN)
- (\*\*) Term: **15 Years**
- (21) Appl. No.: **29/761,173**
- (22) Filed: **Dec. 7, 2020**
- (51) **LOC (13) Cl.** ..... **21-03**
- (52) **U.S. Cl.**  
USPC ..... **D21/719; D21/735**
- (58) **Field of Classification Search**  
USPC ..... **D21/811, 814, 818-822, 835**  
CPC ..... **A63G 21/00-21/22; A63G 31/00; A63G 31/12**  
  
See application file for complete search history.

(56) **References Cited**

**U.S. PATENT DOCUMENTS**

D207,105 S *	3/1967	Gale	.....	D21/818
D217,486 S *	5/1970	McHugh	.....	D21/820
5,074,563 A *	12/1991	Gorman	.....	A63B 60/00 473/350
D328,326 S *	7/1992	Kuan	.....	D21/818
D336,672 S *	6/1993	Gorman	.....	D21/749
D340,965 S *	11/1993	Lee	.....	D21/818
D392,363 S *	3/1998	Jonas	.....	D21/821
D395,476 S *	6/1998	Pond	.....	D21/747
D428,959 S *	8/2000	Addleman	.....	D21/820
D429,306 S *	8/2000	Addleman	.....	D21/818

D440,622 S *	4/2001	Gourchounian	.....	D21/820
D449,866 S *	10/2001	Miller	.....	D21/747
D460,141 S *	7/2002	Gourchounian	.....	D21/820
D469,834 S *	2/2003	Saraie	.....	D21/749
D472,292 S *	3/2003	Peterson	.....	D21/818
D473,605 S *	4/2003	Petersen	.....	D21/747
6,551,200 B1 *	4/2003	Golden	.....	A63B 53/04 473/349
D476,048 S *	6/2003	Cleveland	.....	D21/747
6,648,767 B1 *	11/2003	Chen	.....	A63G 21/18 472/117
6,695,714 B1 *	2/2004	Bliss	.....	A63B 53/047 473/328
D488,201 S *	4/2004	Wahl	.....	D21/747
D522,082 S *	5/2006	Peterson	.....	D21/818
D524,899 S *	7/2006	VanDeusen	.....	D21/820
D529,980 S *	10/2006	Rieber	.....	A63G 21/10 D21/821
D531,688 S *	11/2006	Frame	.....	D21/747
D533,610 S *	12/2006	Cleveland	.....	D21/747
D536,052 S *	1/2007	Han	.....	D21/822
D540,413 S *	4/2007	McKee	.....	D21/818
D556,287 S *	11/2007	Robinson	.....	D21/819
D556,288 S *	11/2007	Robinson	.....	D21/815

(Continued)

*Primary Examiner* — Mitchell I. Siegel

(57) **CLAIM**

The ornamental design for an inflatable waterslide, as shown and described.

**DESCRIPTION**

FIG. 1 is a perspective view of an inflatable waterslide showing our new design;  
FIG. 2 is another perspective view thereof;  
FIG. 3 is a front elevational view thereof;  
FIG. 4 is a rear elevational view thereof;  
FIG. 5 is a left side elevational view thereof;  
FIG. 6 is a right side elevational view thereof; and,  
FIG. 7 is a top plan view thereof.

**1 Claim, 7 Drawing Sheets**



(56)

References Cited

U.S. PATENT DOCUMENTS

7,300,354 B2 *	11/2007	Field	.....	A63G 31/12	D773,575 S *	12/2016	Nicolette	.....	D21/747
				472/117	D815,709 S *	4/2018	Wang	.....	D21/818
D557,368 S *	12/2007	Berenson	.....	D21/818	D816,787 S *	5/2018	Nicolette	.....	D21/747
D557,369 S *	12/2007	Robinson	.....	D21/818	D822,782 S *	7/2018	Wang	.....	D21/820
D577,408 S *	9/2008	Ketcherside	.....	D21/821	D823,418 S *	7/2018	Bagumyan	.....	D21/833
D587,327 S *	2/2009	Ines	.....	D21/747	D824,471 S *	7/2018	Bagumyan	.....	D21/818
D589,110 S *	3/2009	Ketcherside	.....	D21/818	D825,016 S *	8/2018	Wang	.....	D21/818
D595,801 S *	7/2009	Boulton	.....	D21/819	D832,965 S *	11/2018	Keller	.....	D21/818
D597,163 S *	7/2009	Boulton	.....	D21/819	D857,830 S *	8/2019	Wang	.....	D21/818
D597,624 S *	8/2009	Boulton	.....	D21/819	D860,358 S *	9/2019	Stokke	.....	D21/747
D600,769 S *	9/2009	Xiao	.....	D21/820	D861,095 S *	9/2019	Wolfe	.....	D21/759
D600,770 S *	9/2009	Xiao	.....	D21/820	D861,107 S *	9/2019	Whincup	.....	D21/811
7,878,877 B2 *	2/2011	Scherba	.....	A63G 9/00	D861,819 S *	10/2019	Whincup	.....	D21/811
				446/220	D862,627 S *	10/2019	Wang	.....	D21/818
7,976,396 B2 *	7/2011	Boretskin	.....	A63G 31/12	D862,628 S *	10/2019	Wang	.....	D21/818
				472/134	D863,481 S *	10/2019	Shimahara	.....	D21/759
D647,587 S *	10/2011	Perlman	.....	D21/818	D866,698 S *	11/2019	Wu	.....	D21/818
D716,391 S *	10/2014	Roche	.....	D21/759	D895,756 S *	9/2020	Whincup	.....	D21/818
D719,627 S *	12/2014	Wieland	.....	D21/759	D900,262 S *	10/2020	Jacobson	.....	D21/747
D723,120 S *	2/2015	Nicolette	.....	D21/747	2007/0167246 A1 *	7/2007	McKee	.....	A63G 31/007
D726,265 S *	4/2015	Nicolette	.....	D21/747					472/116
D730,469 S *	5/2015	Chen	.....	D21/819	2015/0231458 A1 *	8/2015	Petersen	.....	A63B 53/047
D730,470 S *	5/2015	Chen	.....	D21/819					473/332
D773,574 S *	12/2016	Oliveiro	.....	D21/747	2017/0028271 A1 *	2/2017	Petersen	.....	A63B 60/54
					2017/0080300 A1 *	3/2017	Milleman	.....	A63B 53/047
					2019/0299069 A1 *	10/2019	Maenaka	.....	A63B 53/042

\* cited by examiner



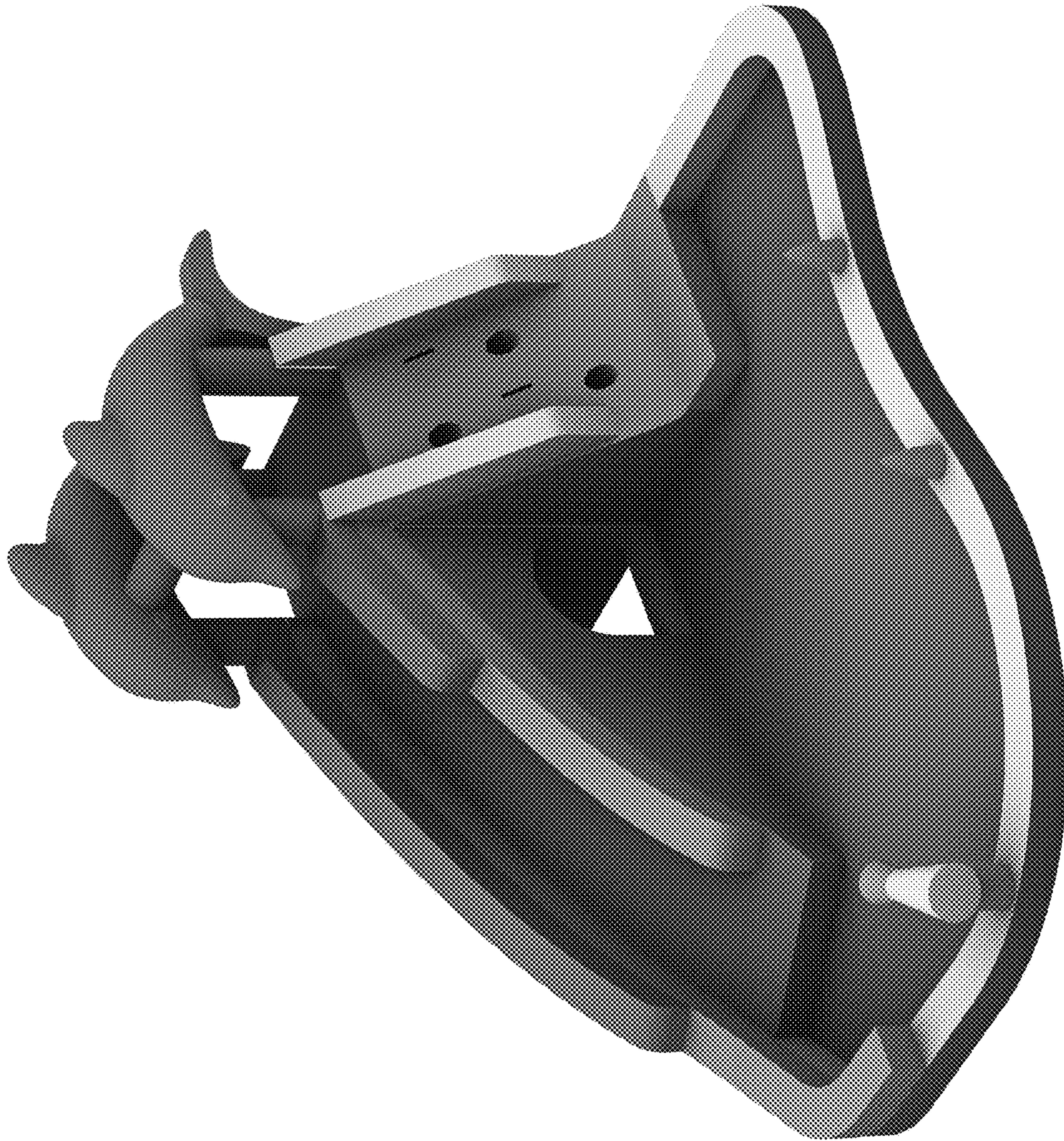

FIG. 1



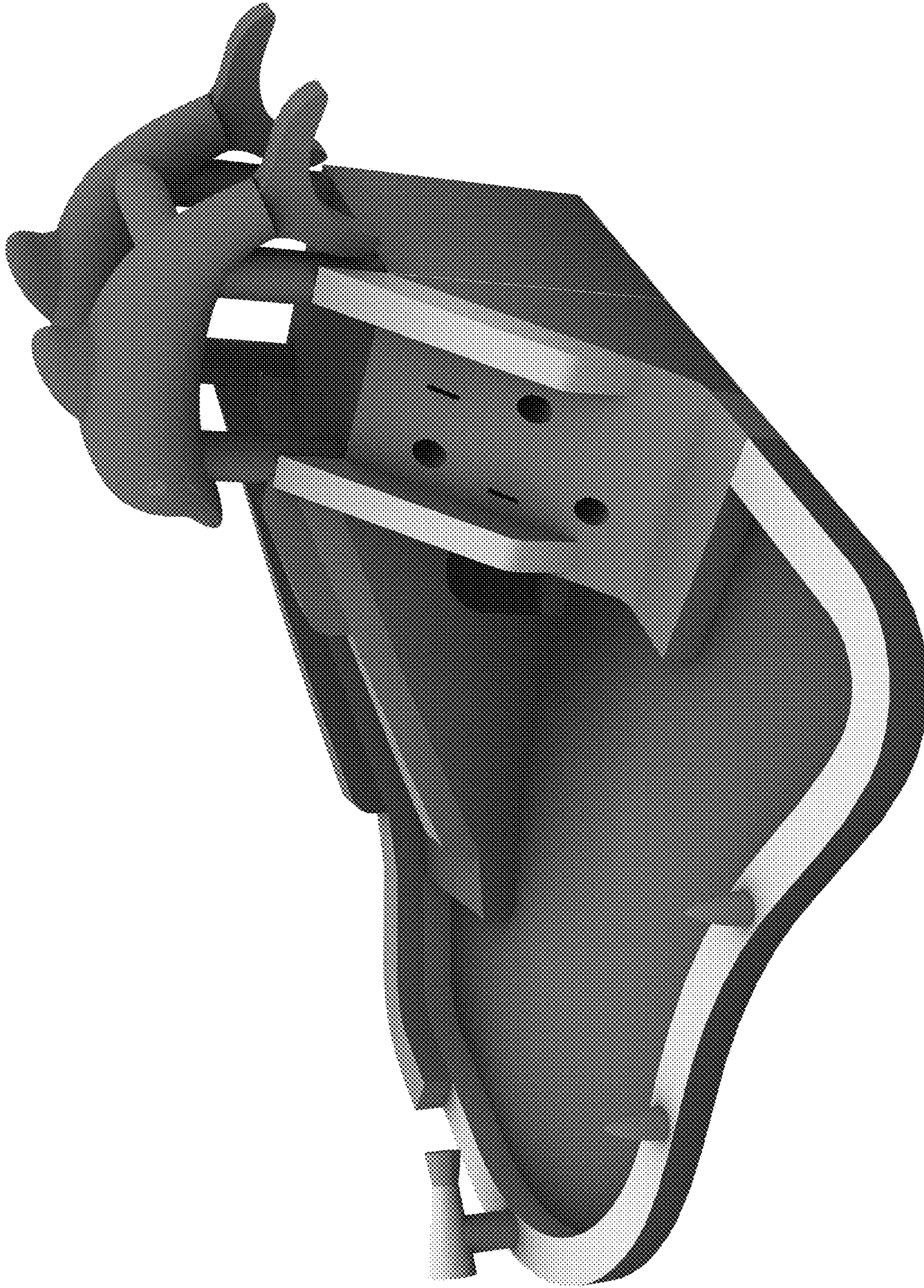

FIG. 2



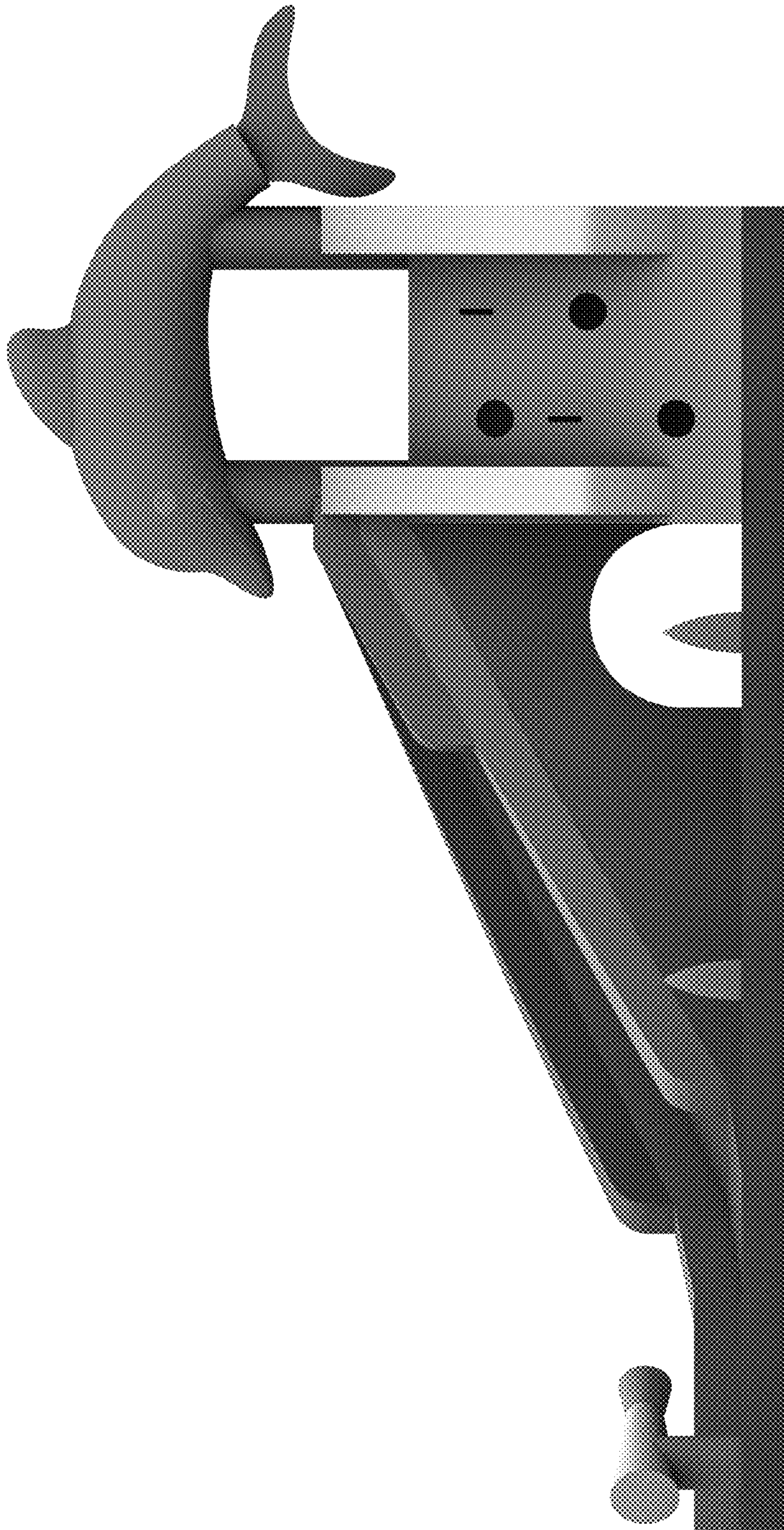

FIG. 3



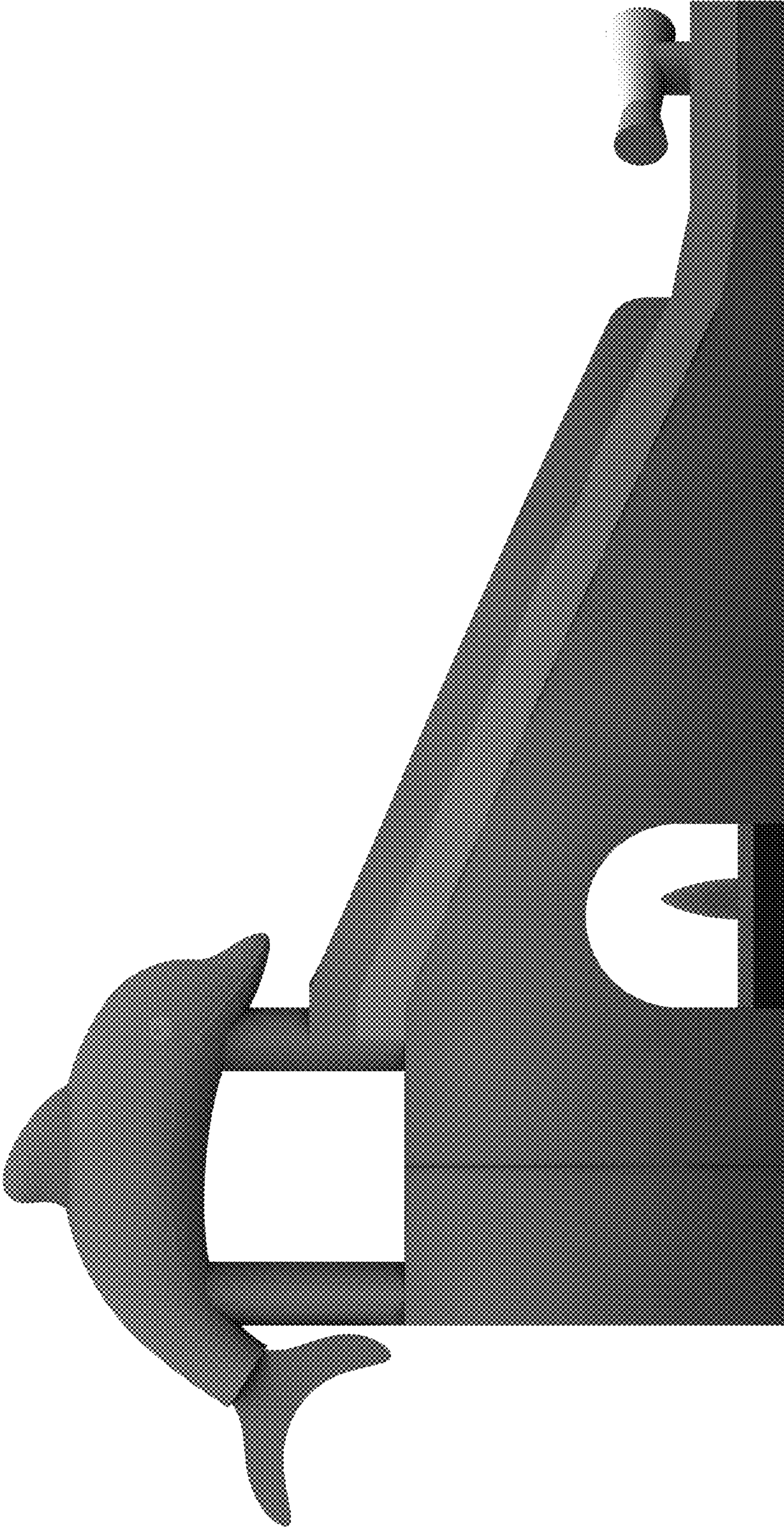

FIG. 4



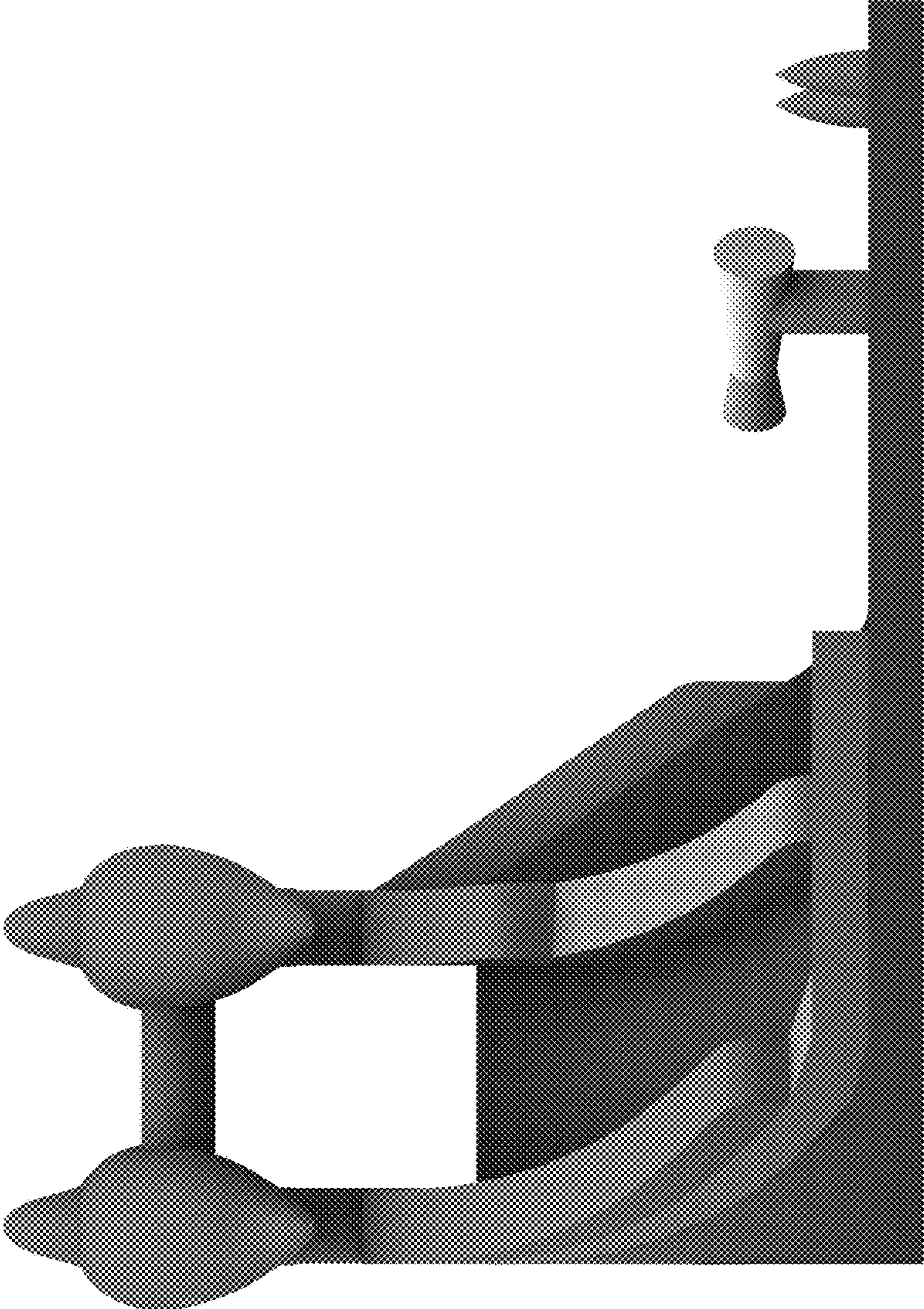

FIG. 5

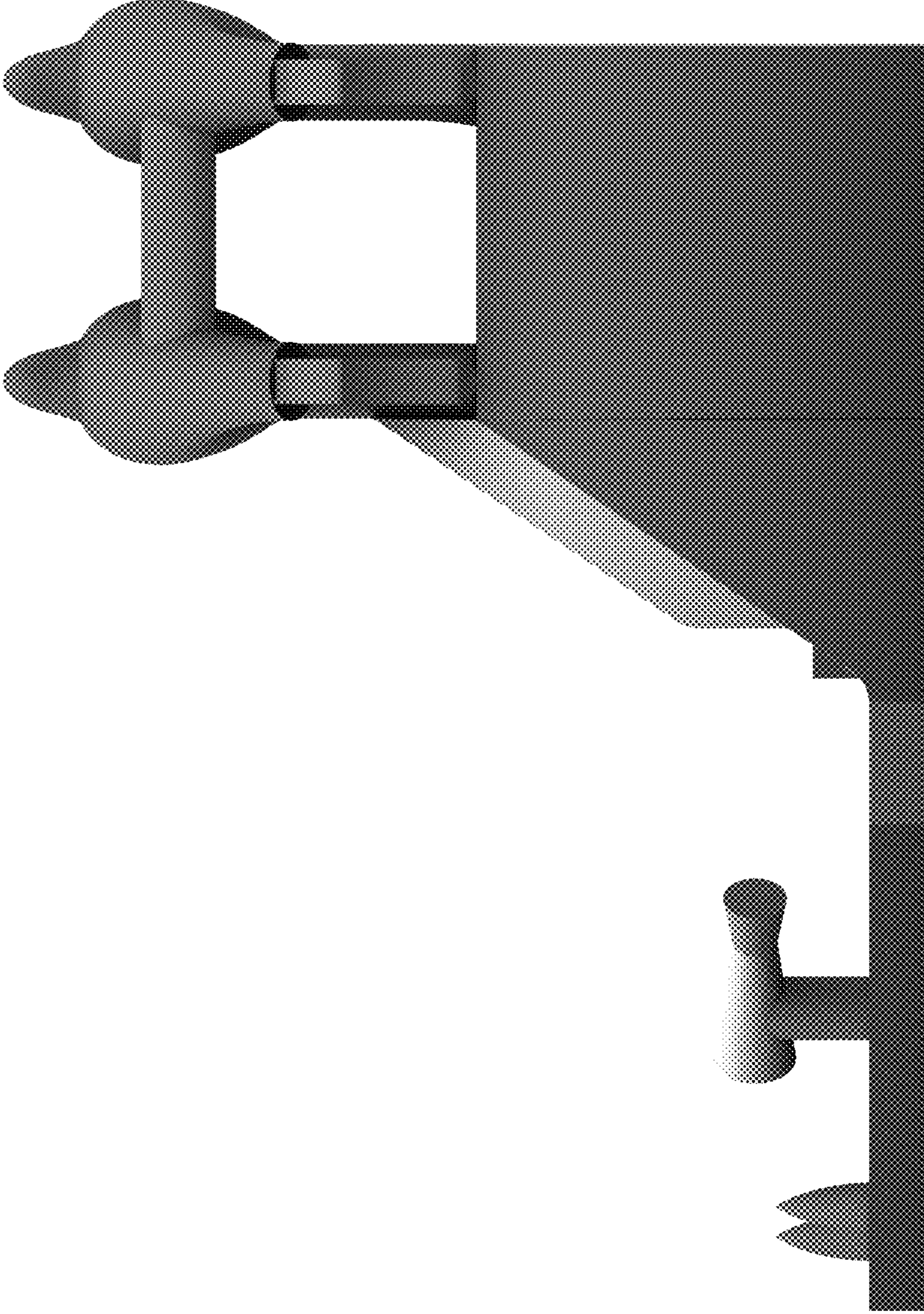

FIG. 6



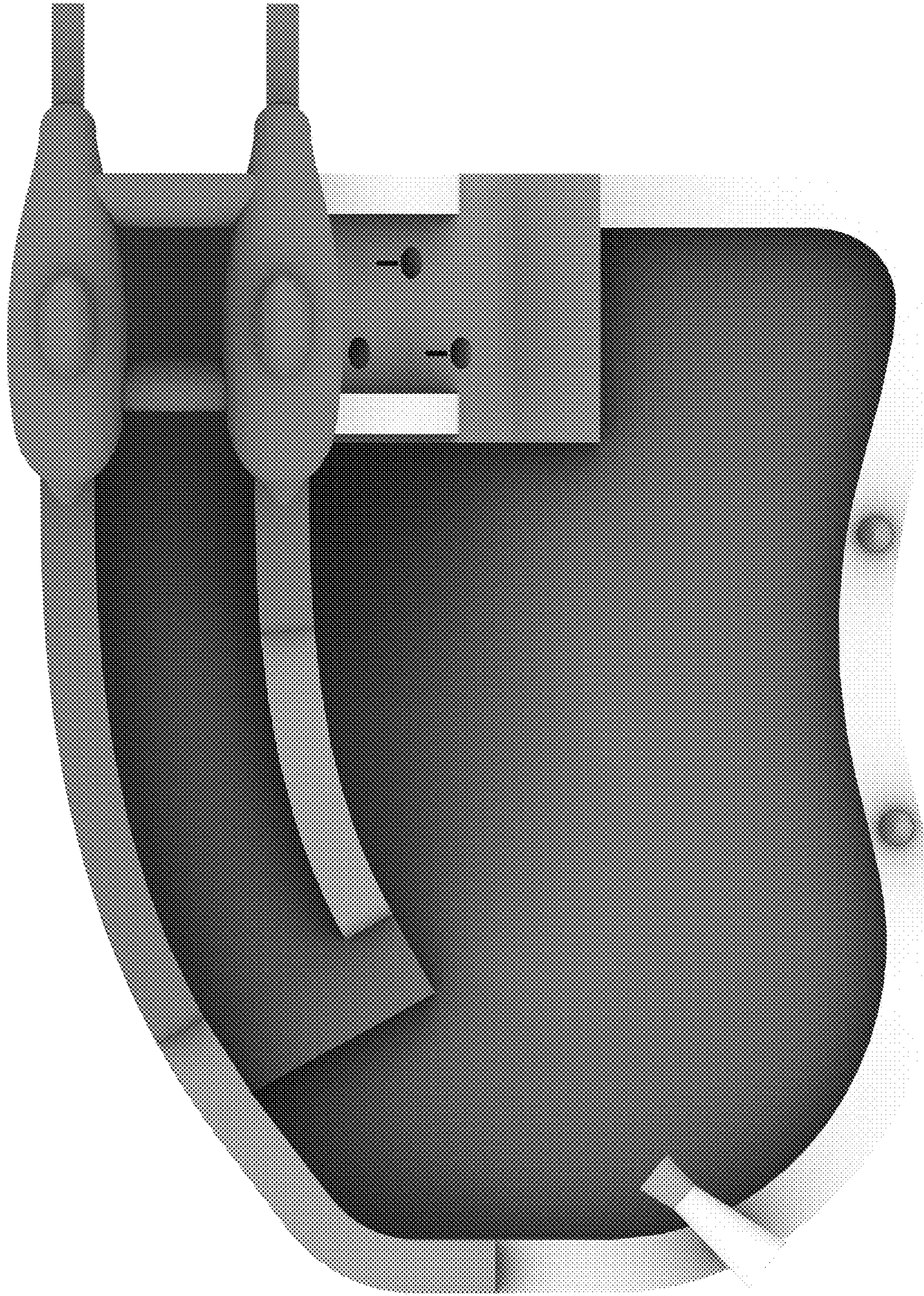

FIG. 7