



US00D921091S

(12) **United States Design Patent**
Wu

(10) **Patent No.:** **US D921,091 S**
(45) **Date of Patent:** **** Jun. 1, 2021**

(54) **PROJECTOR**

(71) Applicant: **Zhipeng Wu**, Shenzhen (CN)

(72) Inventor: **Zhipeng Wu**, Shenzhen (CN)

(**) Term: **15 Years**

(21) Appl. No.: **29/762,996**

(22) Filed: **Dec. 21, 2020**

(51) **LOC (13) Cl.** **16-02**

(52) **U.S. Cl.**
USPC **D16/230**

(58) **Field of Classification Search**
USPC D16/221, 225, 230-231, 234; D21/514
CPC G03B 21/145; G03B 21/14; G03B 21/16;
G03B 21/00; G03B 21/003; G03B 21/12
See application file for complete search history.

(56) **References Cited**

U.S. PATENT DOCUMENTS

D472,571 S *	4/2003	Williams	D16/230
D487,903 S	3/2004	Panasewicz et al.		
D494,994 S	8/2004	Salvatori et al.		
D711,452 S *	8/2014	Song	D16/230
D828,431 S *	9/2018	Gan	D16/230
D831,727 S *	10/2018	Xu	D16/225
D850,517 S *	6/2019	Li	D16/230
D850,518 S *	6/2019	Gan	D16/230

D859,505 S *	9/2019	Wang	D16/230
D865,033 S *	10/2019	Cheng	D16/230
D871,489 S *	12/2019	Wan	D16/230
D896,299 S *	9/2020	Ou	D16/230

* cited by examiner

Primary Examiner — Wan Laymon

(57) **CLAIM**

The ornamental design for a projector, as shown and described.

DESCRIPTION

FIG. 1 is a perspective view of a projector showing my new design;
FIG. 2 is another perspective view thereof;
FIG. 3 is a front elevational view thereof;
FIG. 4 is a rear elevational view thereof;
FIG. 5 is a left side elevational view thereof;
FIG. 6 is a right side elevational view thereof;
FIG. 7 is a top plan view thereof;
FIG. 8 is a bottom plan view thereof; and,
FIG. 9 is an enlarged view of portion 9 shown in FIG. 2.
The broken lines in the drawings depict portions of the projector that form no part of the claimed design.

1 Claim, 9 Drawing Sheets

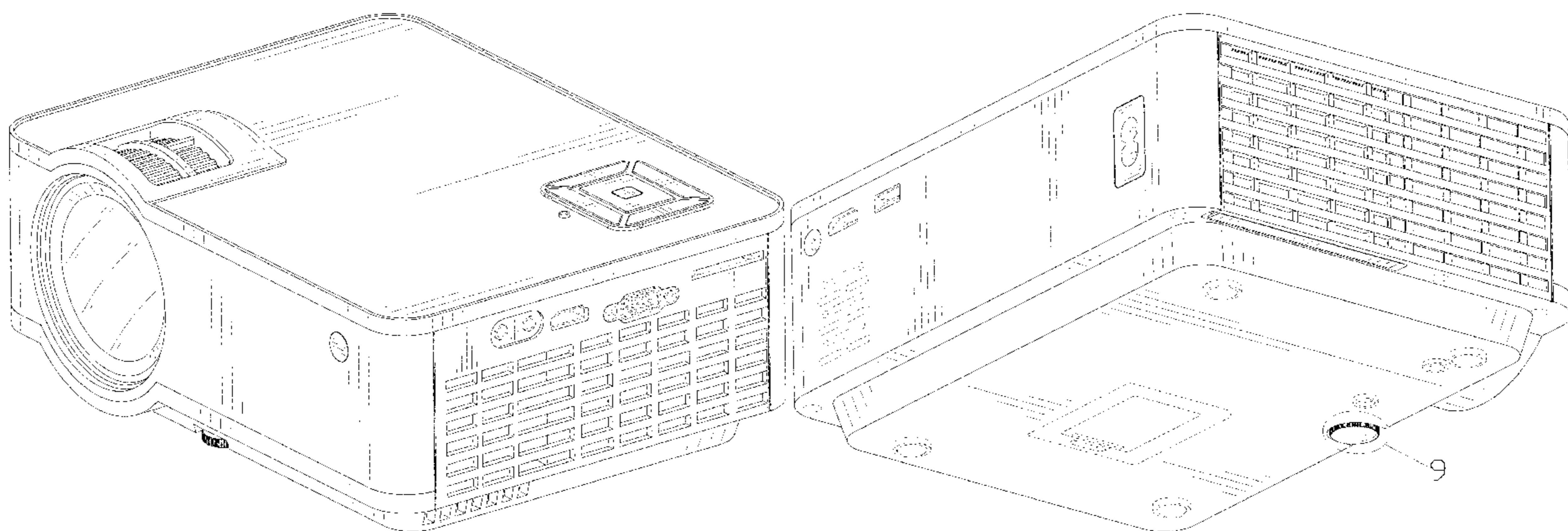

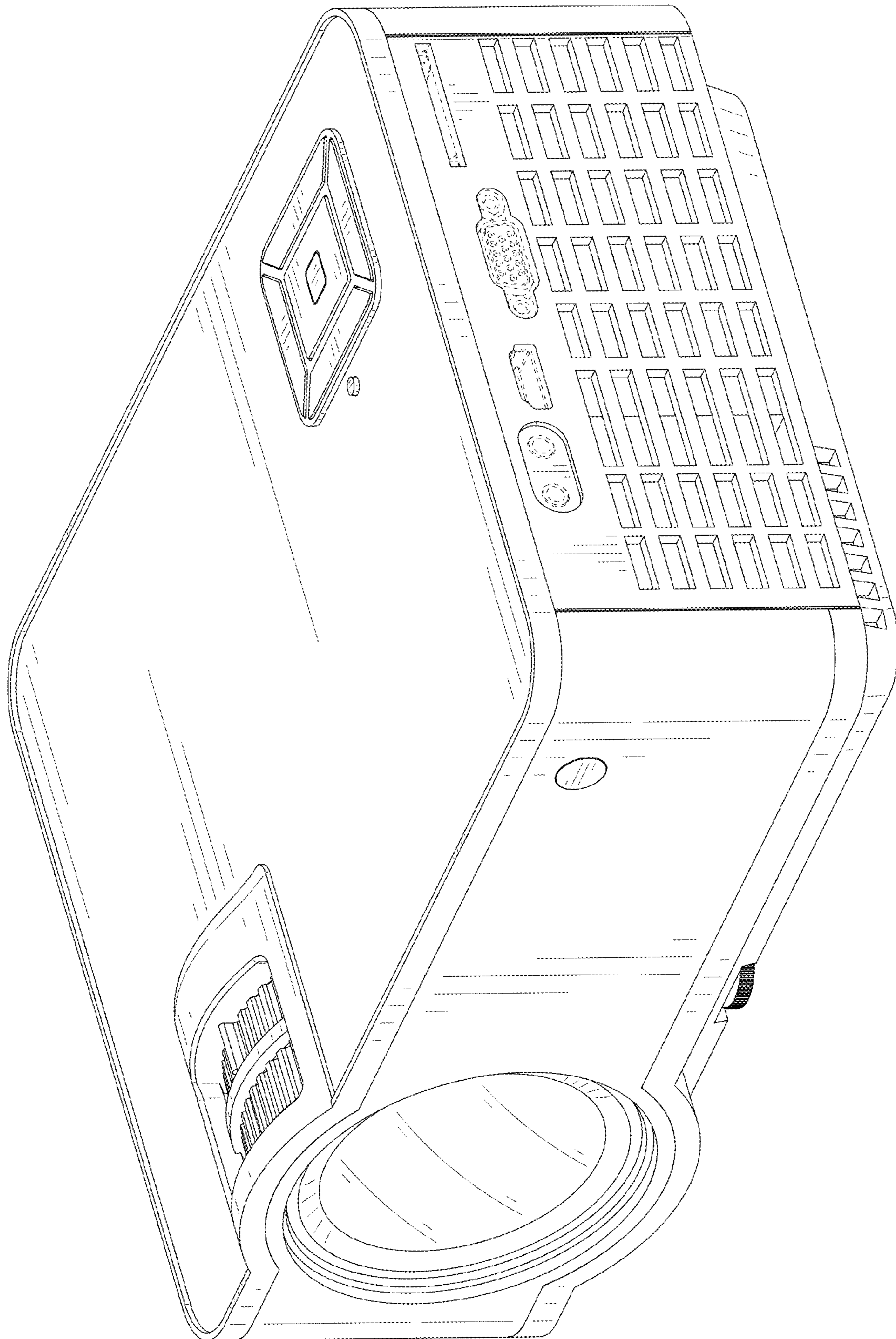

FIG. 1

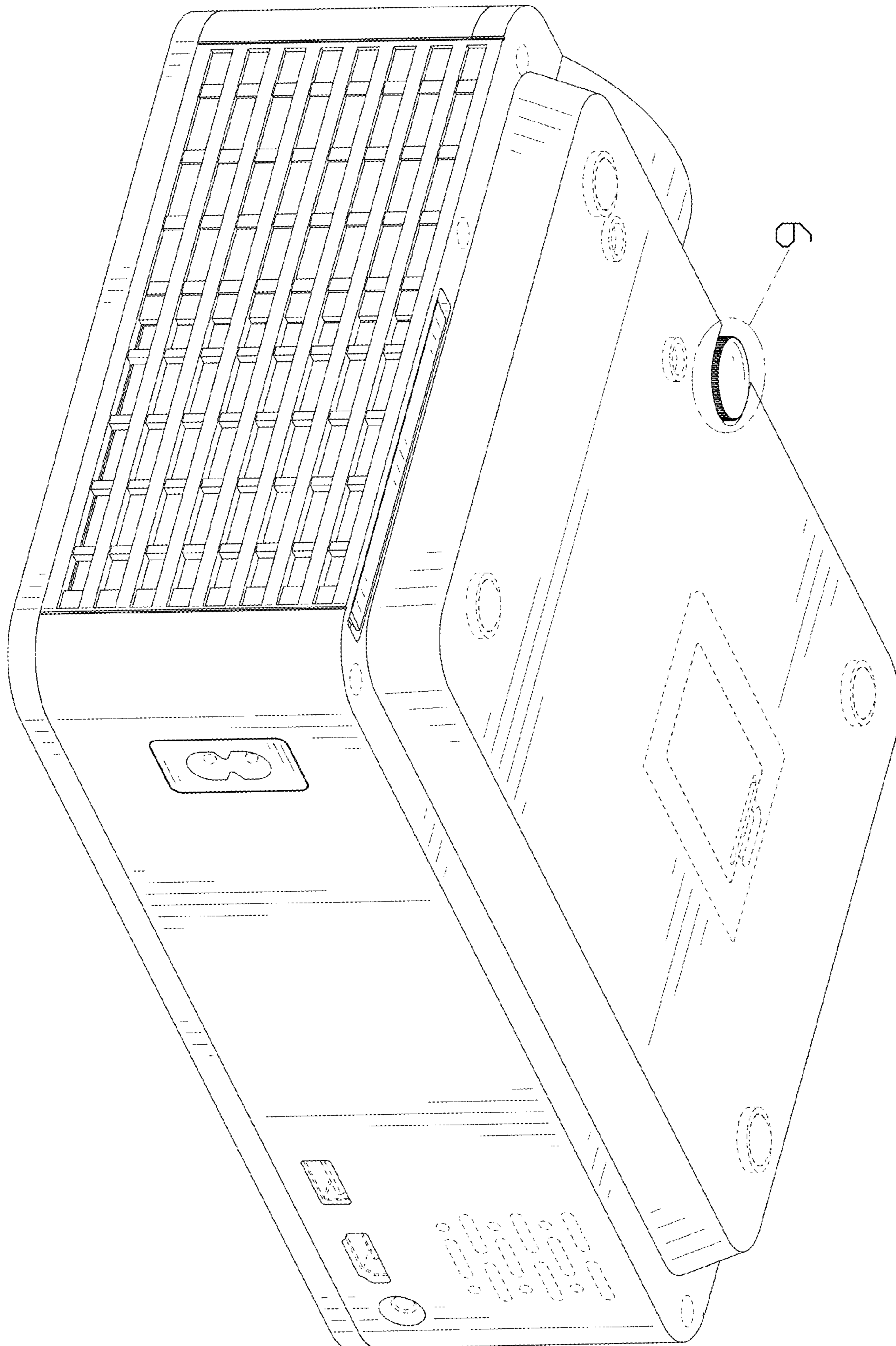

FIG. 2

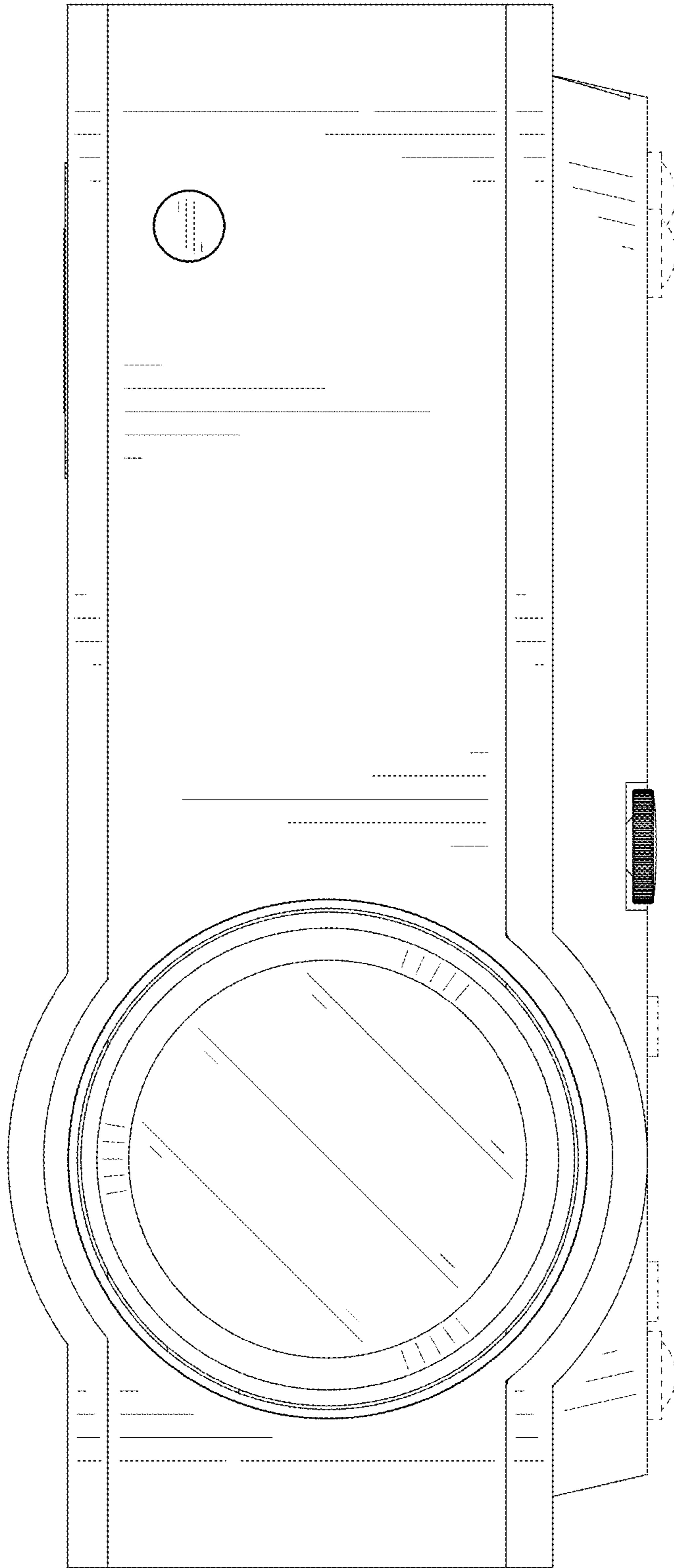

FIG. 3

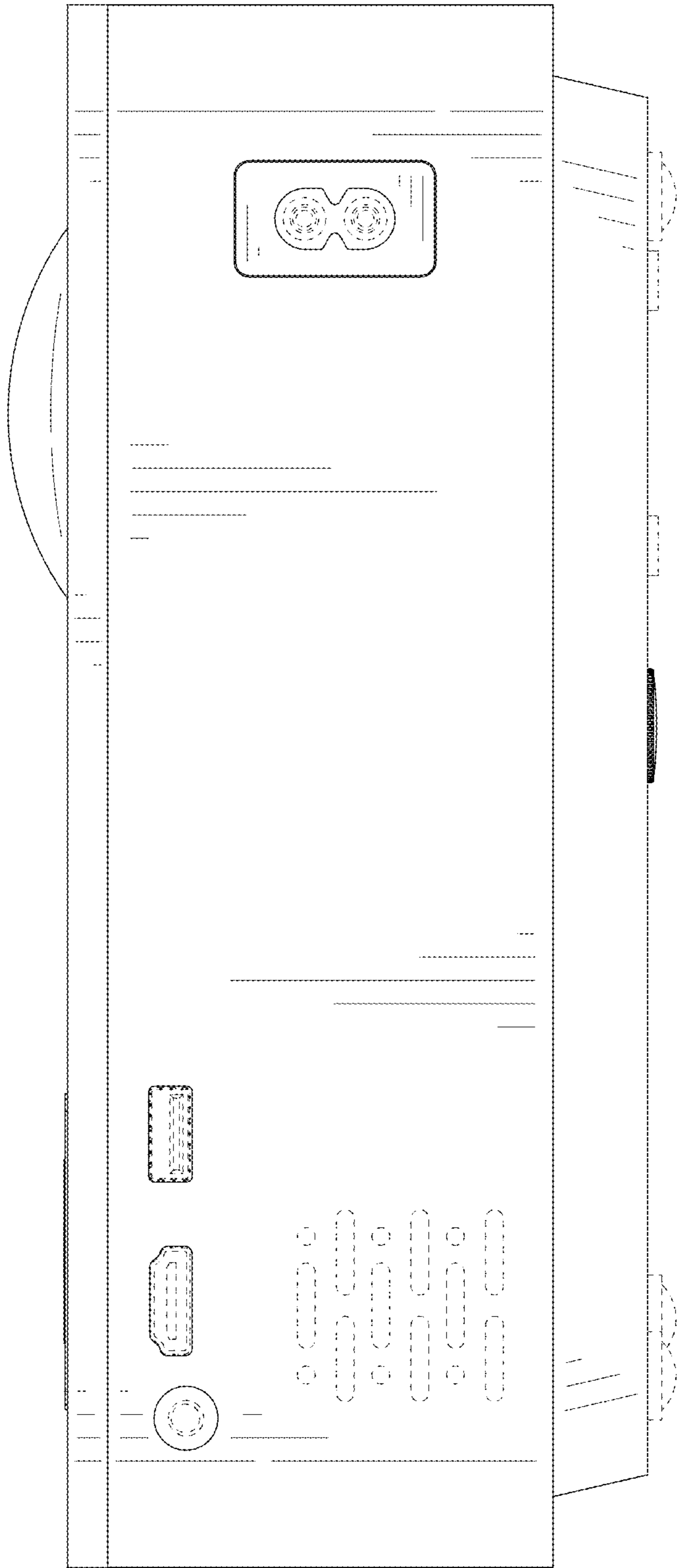

FIG. 4

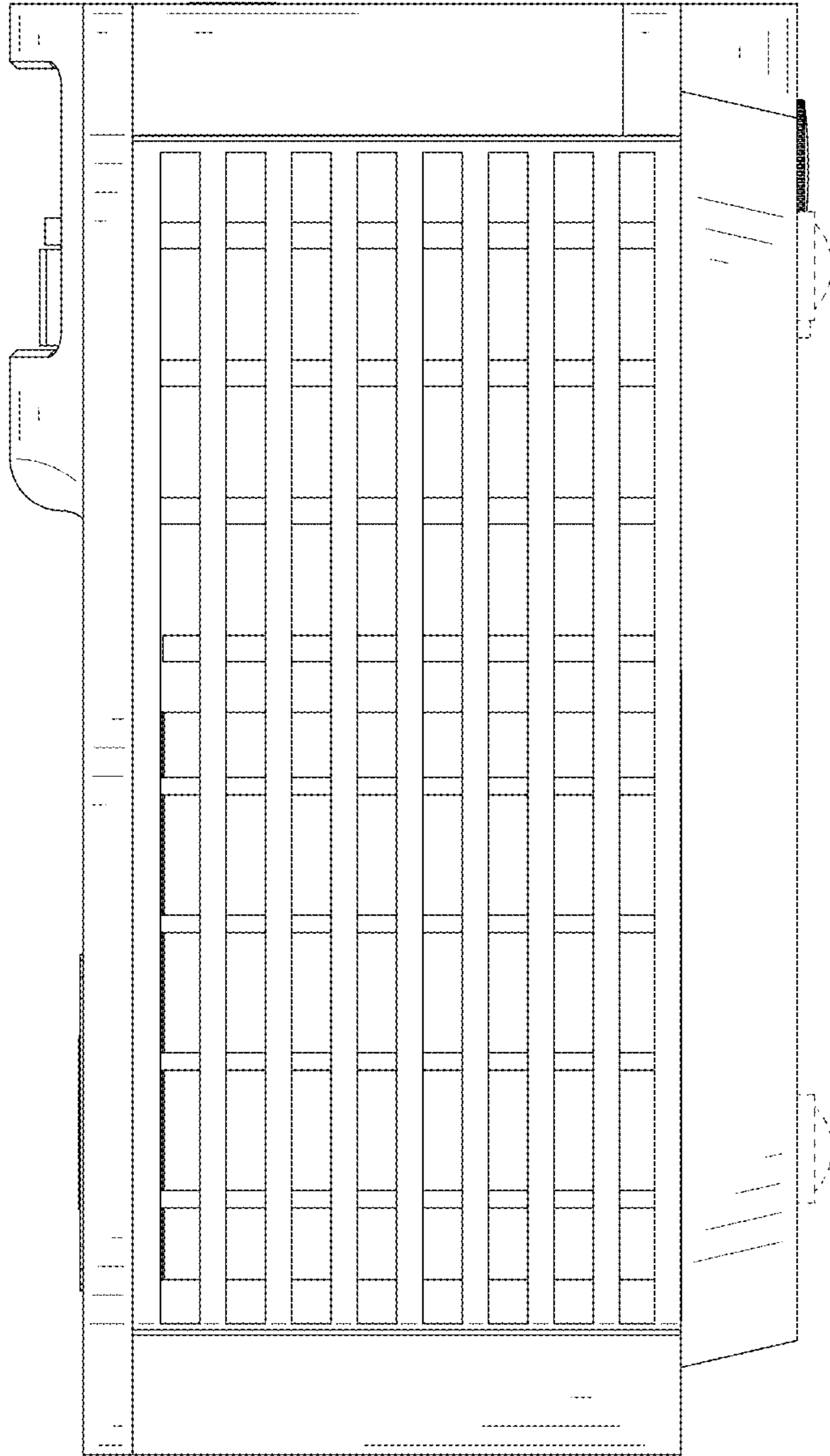

FIG. 5

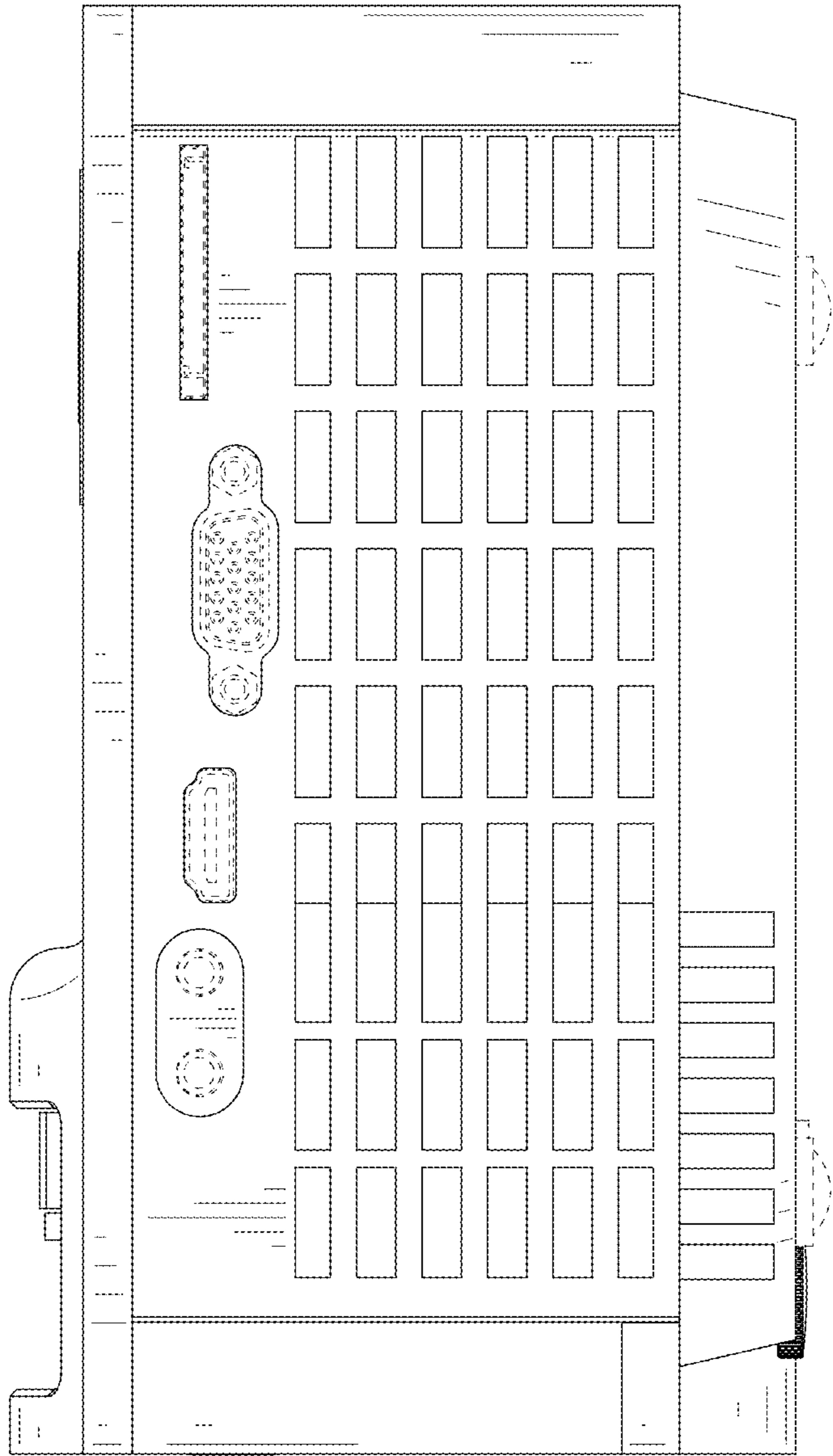

FIG. 6

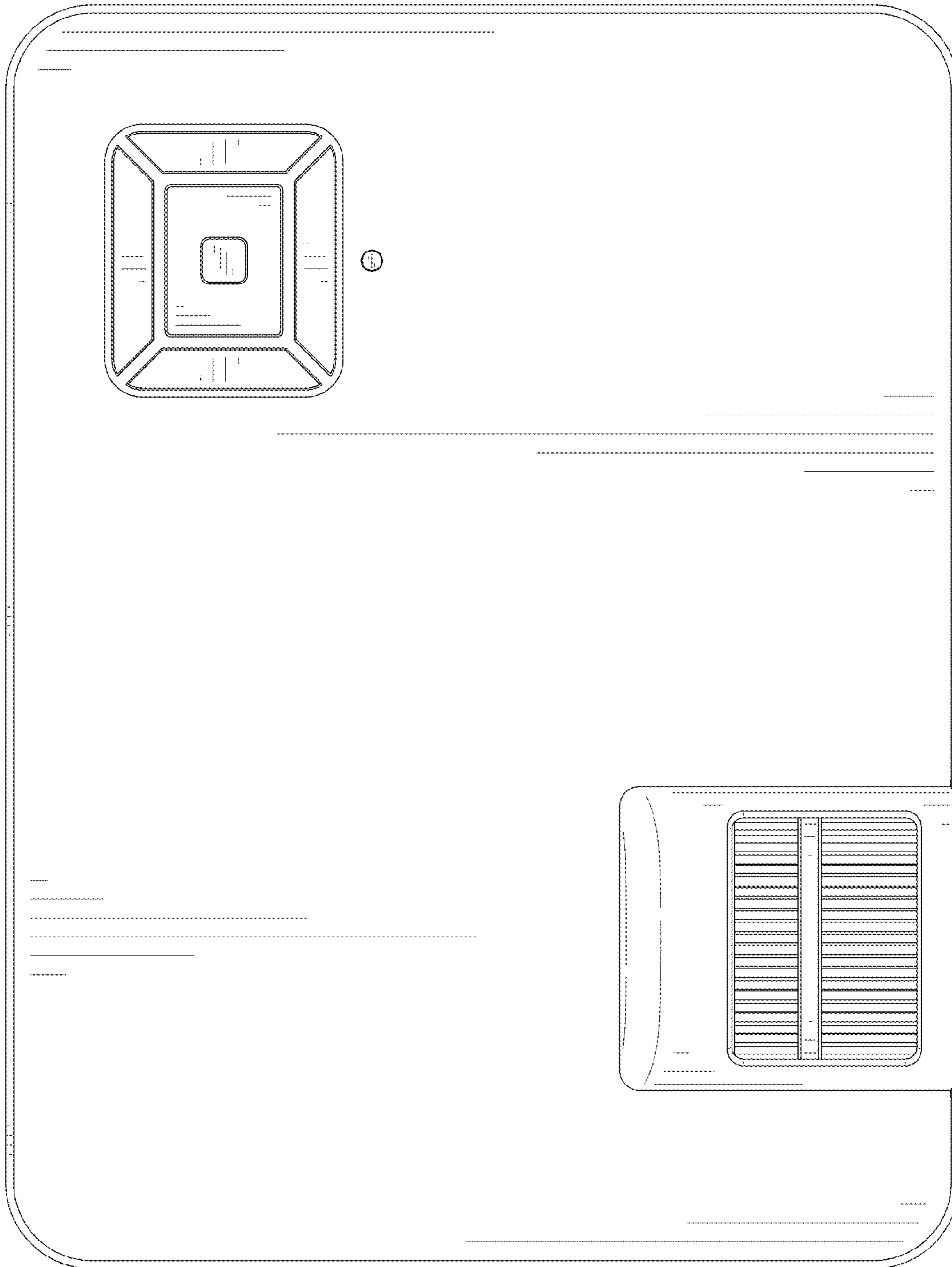

FIG. 7

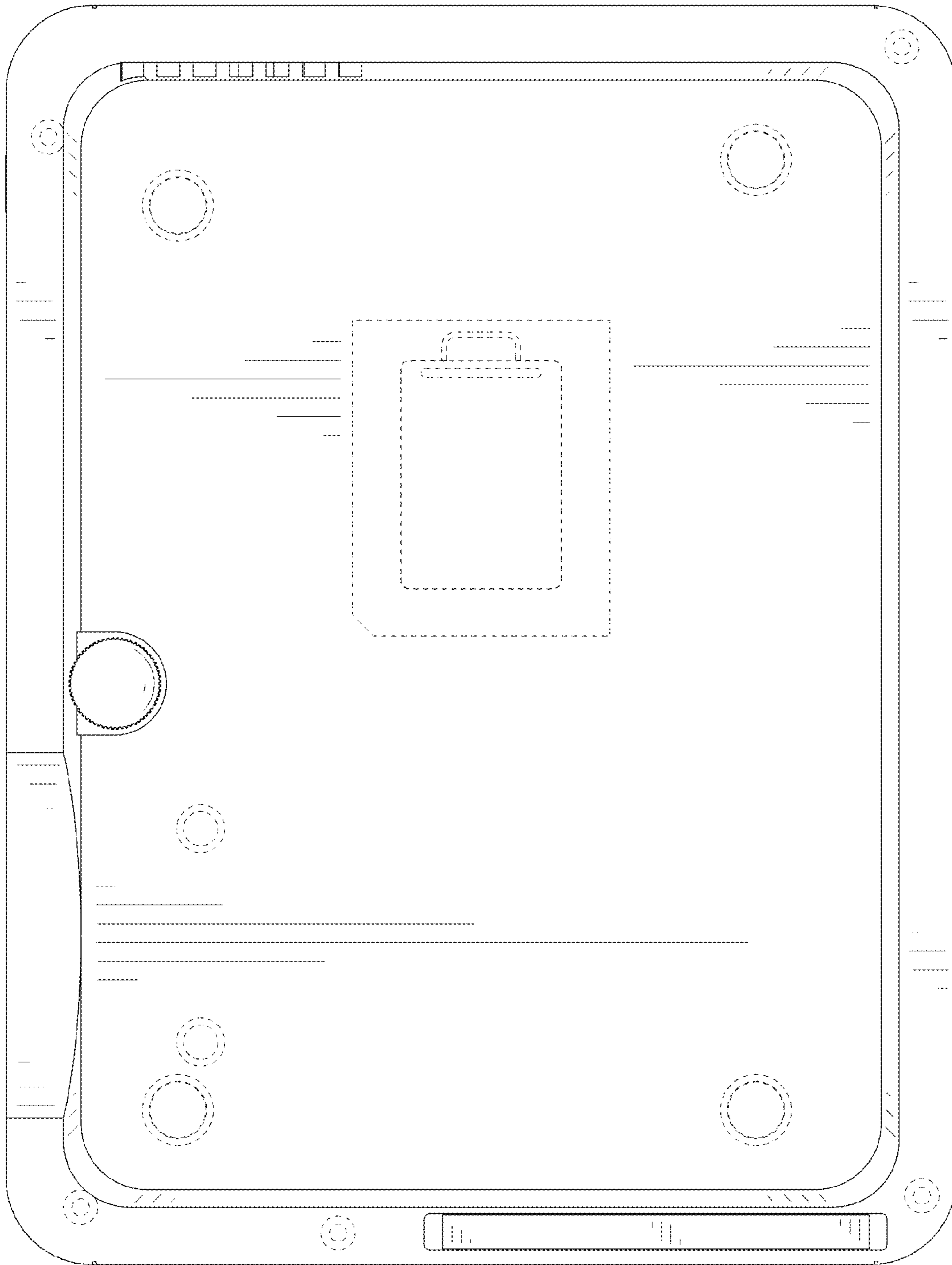

FIG. 8

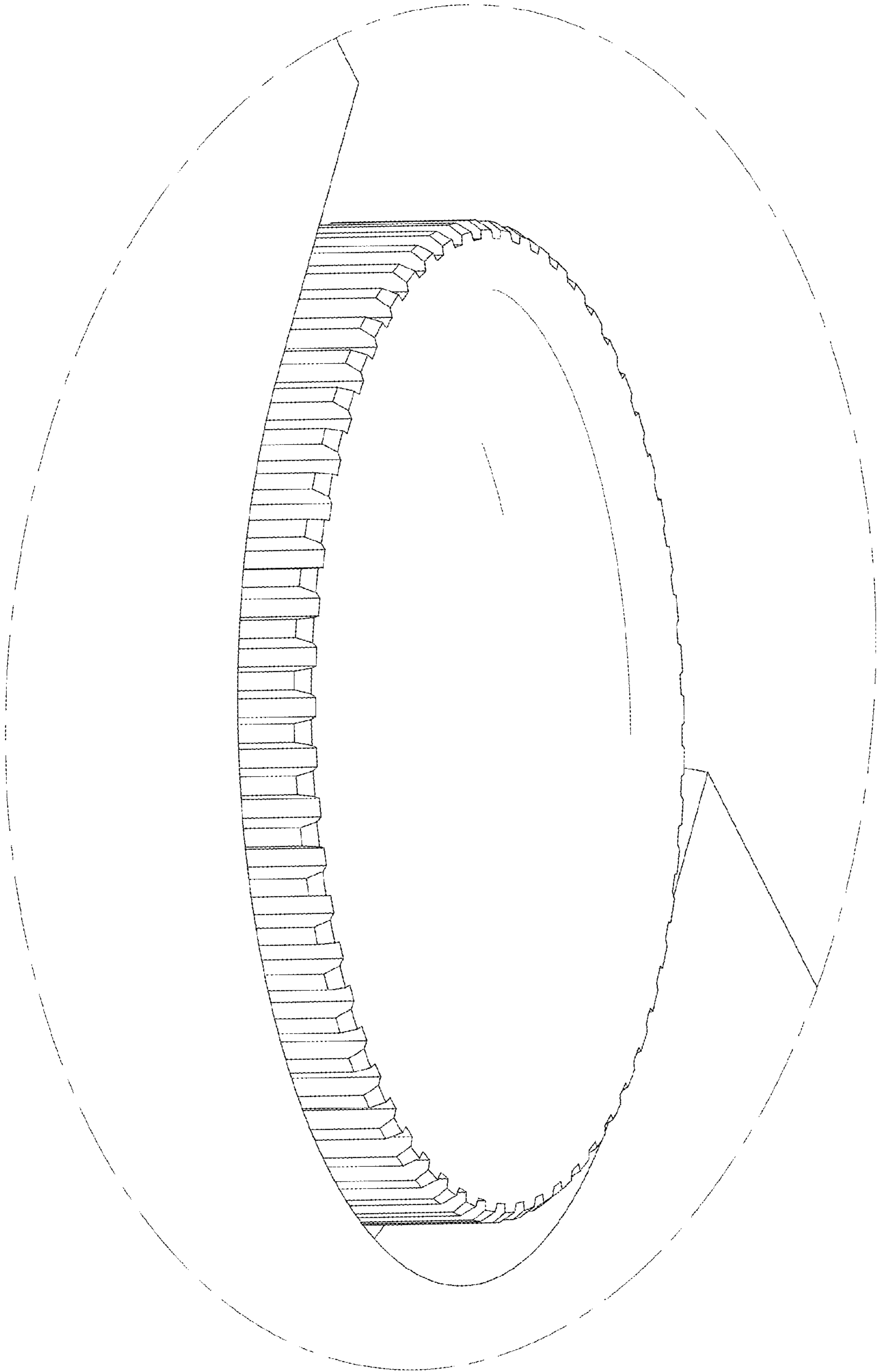

FIG. 9