



US00D920927S

(12) **United States Design Patent**
Tachibana et al.

(10) **Patent No.:** **US D920,927 S**
(45) **Date of Patent:** **** Jun. 1, 2021**

(54) **SIGNAL RELAY DEVICE**

(71) Applicant: **Mitsubishi Electric Corporation,**
Tokyo (JP)

(72) Inventors: **Atsuki Tachibana,** Tokyo (JP); **Atsushi Kondo,** Tokyo (JP); **Takayuki Miyazaki,** Tokyo (JP)

(73) Assignee: **Mitsubishi Electric Corporation,**
Tokyo (JP)

(**) Term: **15 Years**

(21) Appl. No.: **29/698,165**

(22) Filed: **Jul. 15, 2019**

(30) **Foreign Application Priority Data**

Mar. 1, 2019 (JP) 2019-004298

(51) **LOC (13) Cl.** **13-03**

(52) **U.S. Cl.**
USPC **D13/159**

(58) **Field of Classification Search**
USPC D13/101, 107, 110, 118, 120, 123, 133,
D13/134, 146, 147, 150–155, 158–163,
D13/173, 175, 177, 184, 199; D14/240,
D14/256, 300–302, 349, 356, 358, 433,
D14/432, 435, 438; D10/46, 104.1
CPC .. G06F 3/067; G06F 11/1076; G06F 11/2094;
G06F 11/3072; G06F 13/1668; G06F
3/0604; G06N 20/00; G05B 19/05; G05B
2219/35458; G05B 2219/35001
See application file for complete search history.

(56) **References Cited**

U.S. PATENT DOCUMENTS

D553,579 S * 10/2007 Takahashi D13/162.1
D758,365 S * 6/2016 Shimano D14/358

D772,820 S * 11/2016 Shimano D13/159
D773,427 S * 12/2016 Kondo D14/155
D774,016 S * 12/2016 Kondo D14/155
D775,102 S * 12/2016 Kondo D14/155
D776,077 S * 1/2017 Kondo D14/155
D790,480 S * 6/2017 Shimano D13/159
9,882,310 B2 * 1/2018 Takahashi H01R 13/514
D856,931 S * 8/2019 Takahashi D13/123
D857,636 S * 8/2019 Ueda D13/162.1
D869,404 S * 12/2019 Ueda D13/162.1
D897,294 S * 9/2020 Kato D13/162.1
2013/0113349 A1 * 5/2013 Miyazaki H05K 5/0247
312/223.1

* cited by examiner

Primary Examiner — Brett Miller

Assistant Examiner — Landon Thomas Cassell

(74) *Attorney, Agent, or Firm* — Stuebaker & Brackett
PC

(57) **CLAIM**

The ornamental design for a signal relay device, as shown and described.

DESCRIPTION

FIG. 1. is a front perspective view of the front, right, and top sides of a signal relay device showing our new design;
FIG. 2. is a rear perspective view of the rear, left, and bottom sides thereof;
FIG. 3. is a front view thereof;
FIG. 4. is a rear view thereof;
FIG. 5. is a top plan view thereof;
FIG. 6. is a bottom plan view thereof;
FIG. 7. is a right side view thereof;
FIG. 8. is a left side view thereof; and,
FIG. 9. is a front view in a state where a cover is opened.
The equal length broken lines in the drawings depict portions of the signal relay device that form no part of the claimed design.

1 Claim, 9 Drawing Sheets

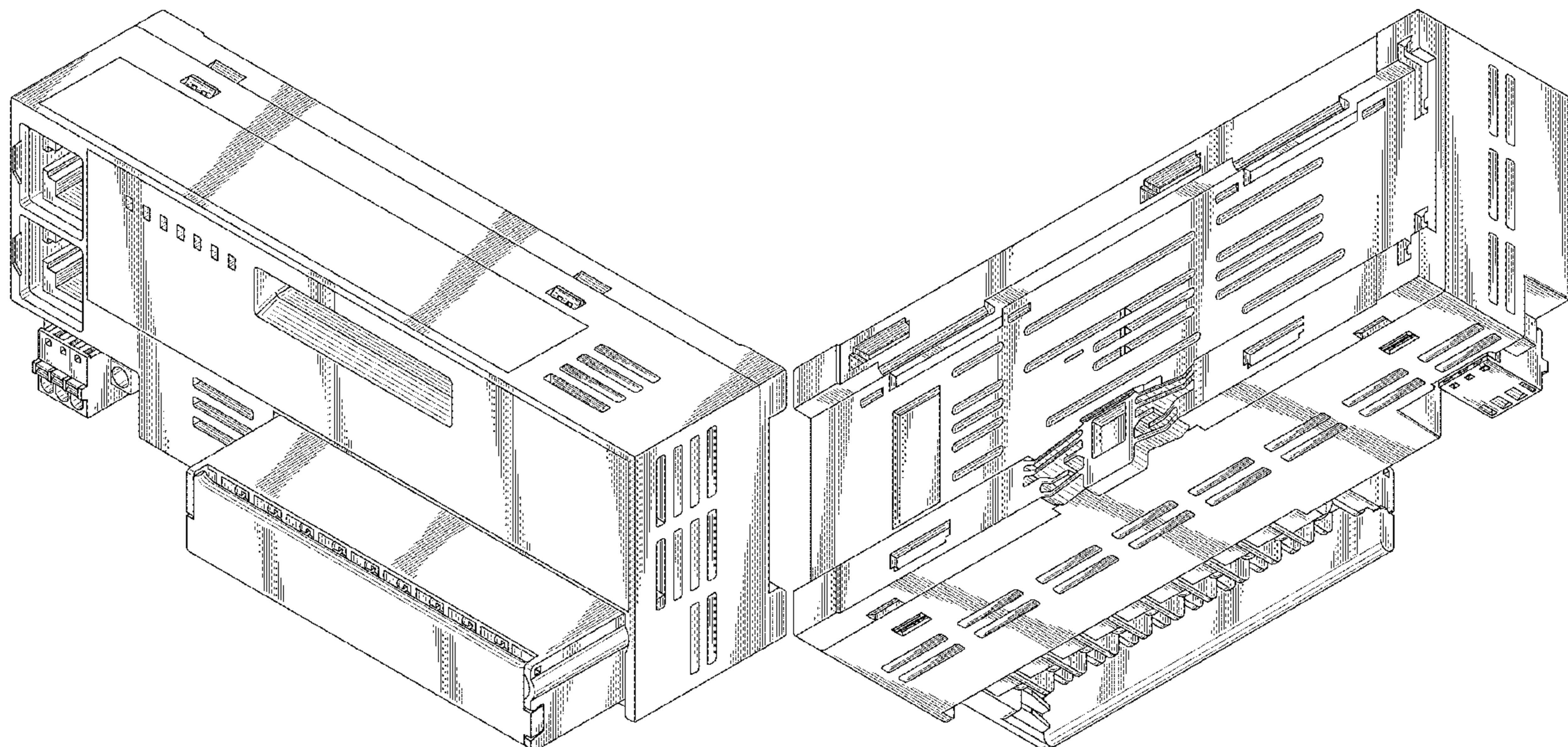
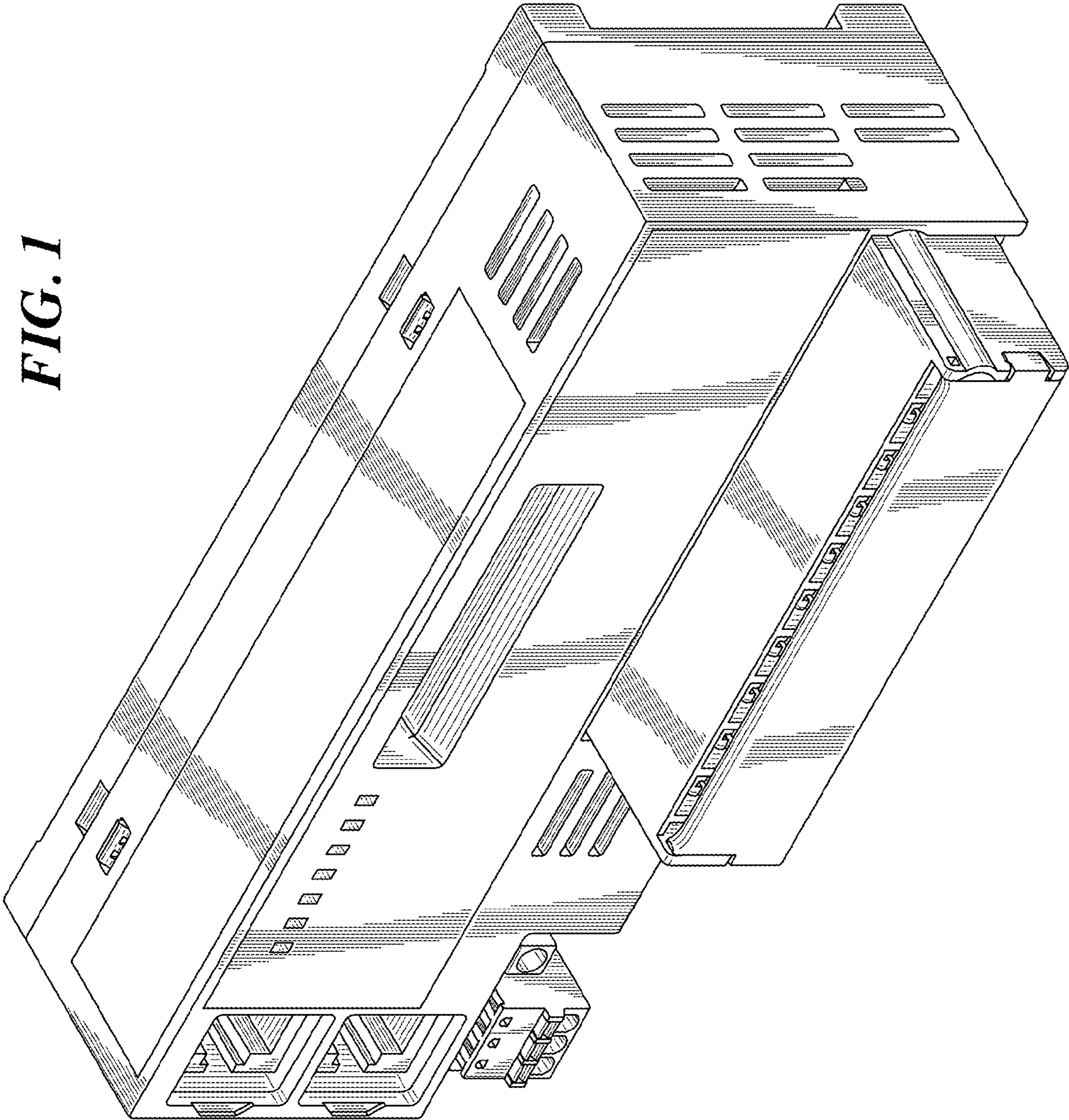

FIG. 1



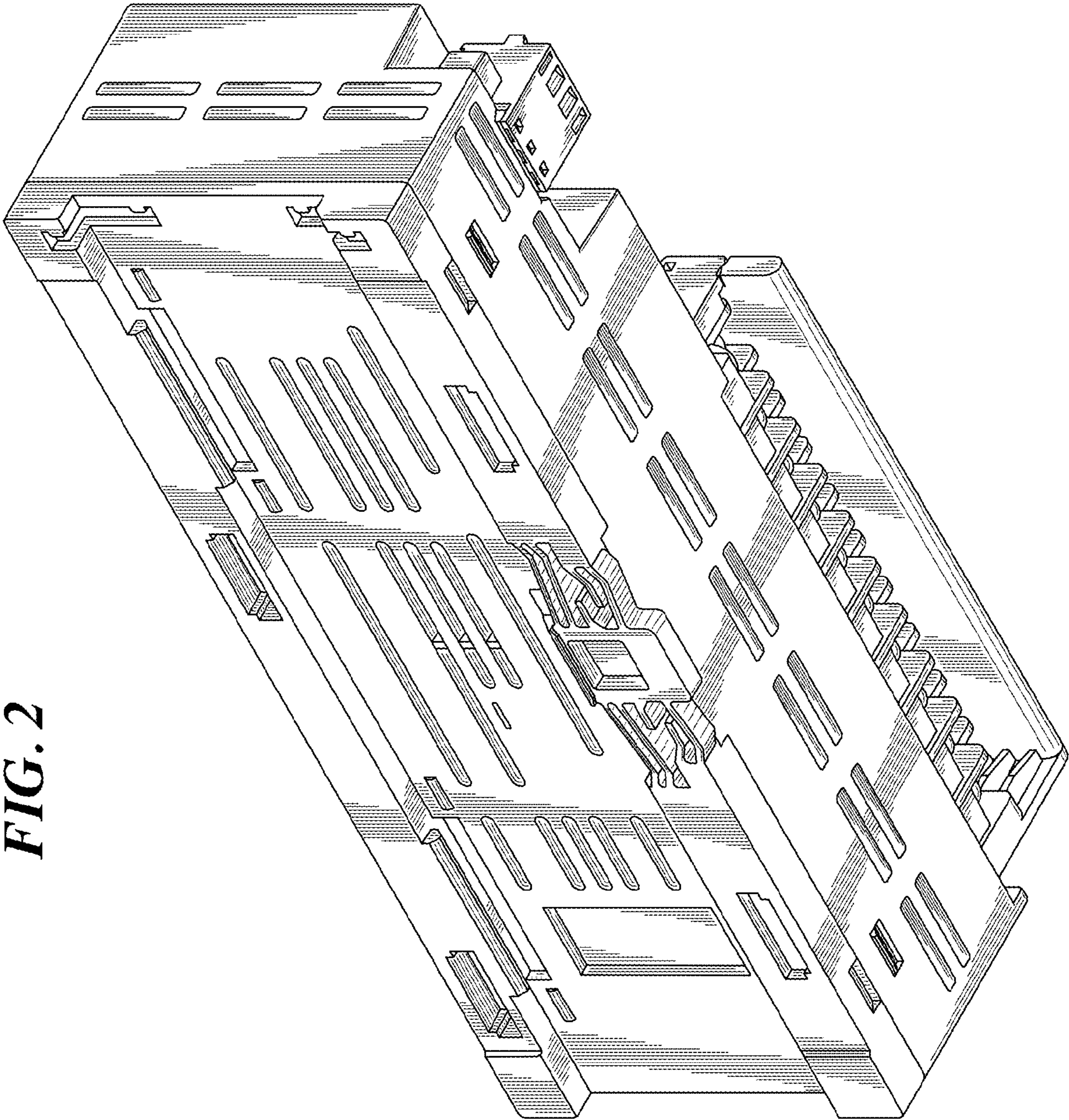

FIG. 2

FIG. 3

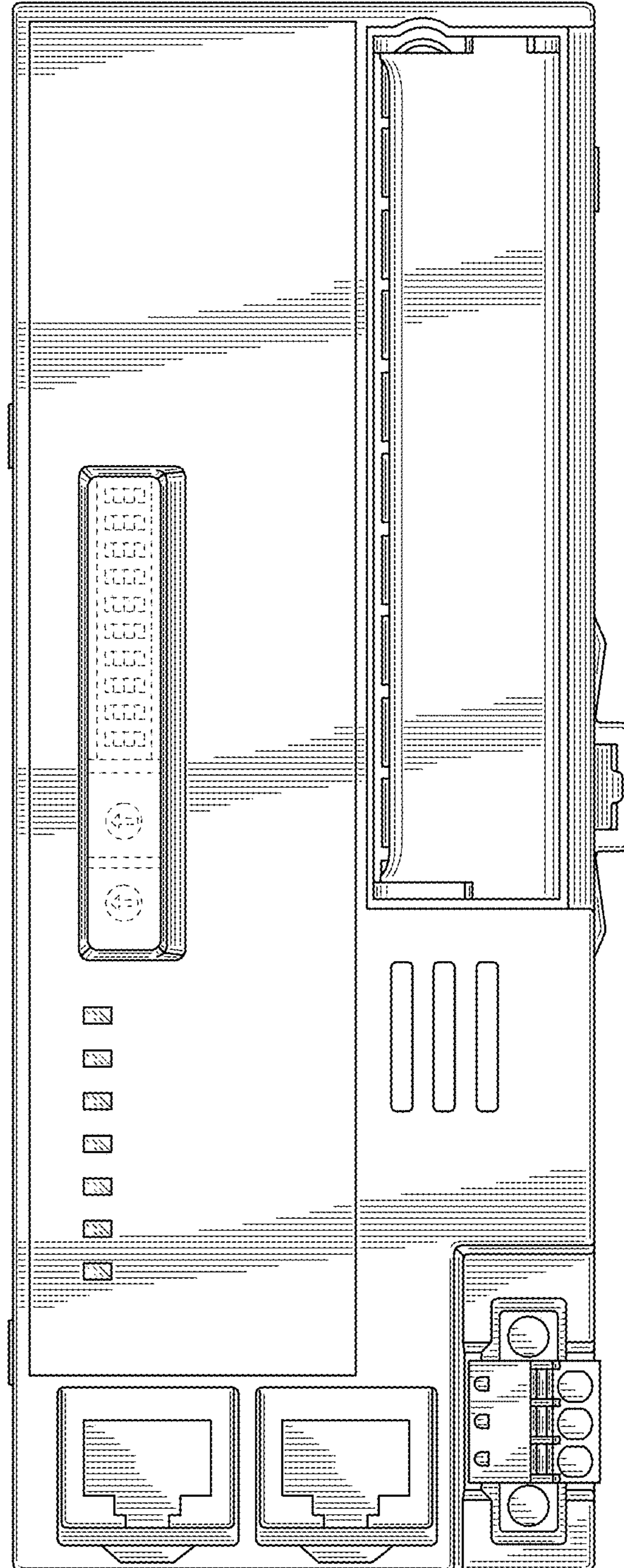

FIG. 4

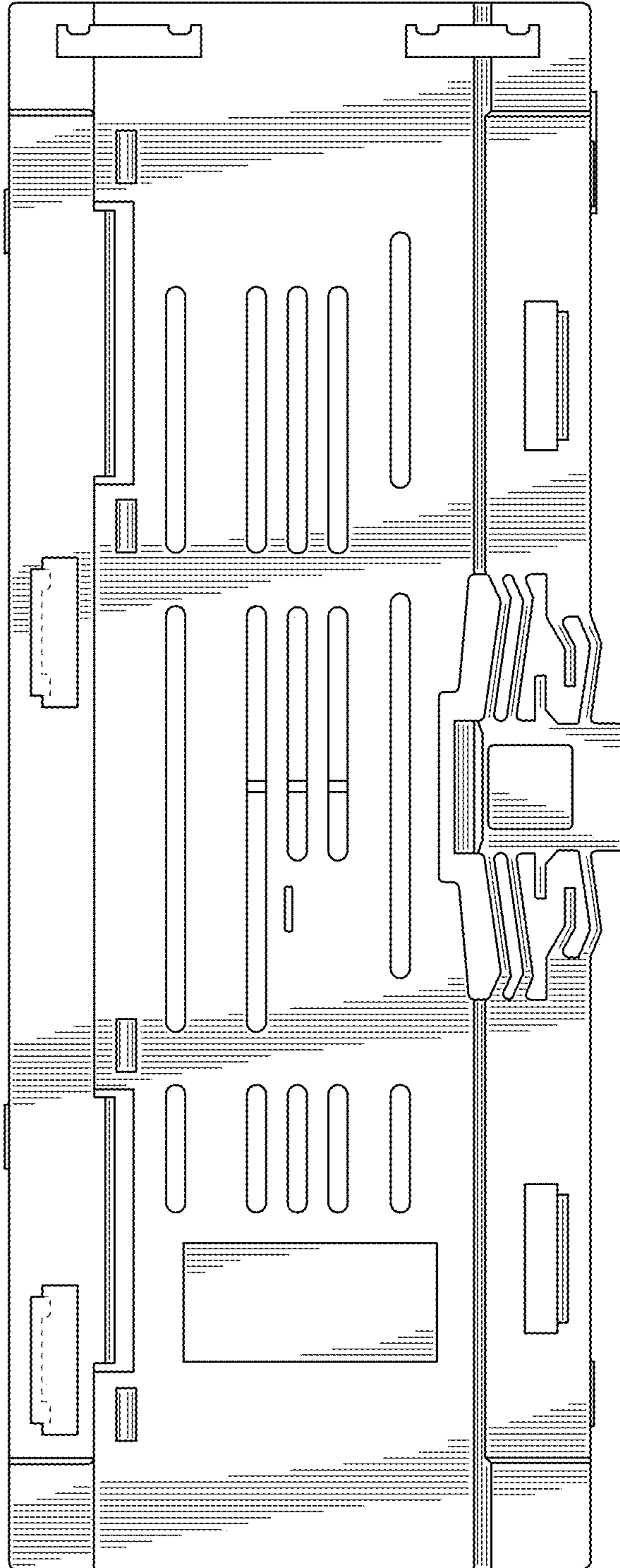

FIG. 5

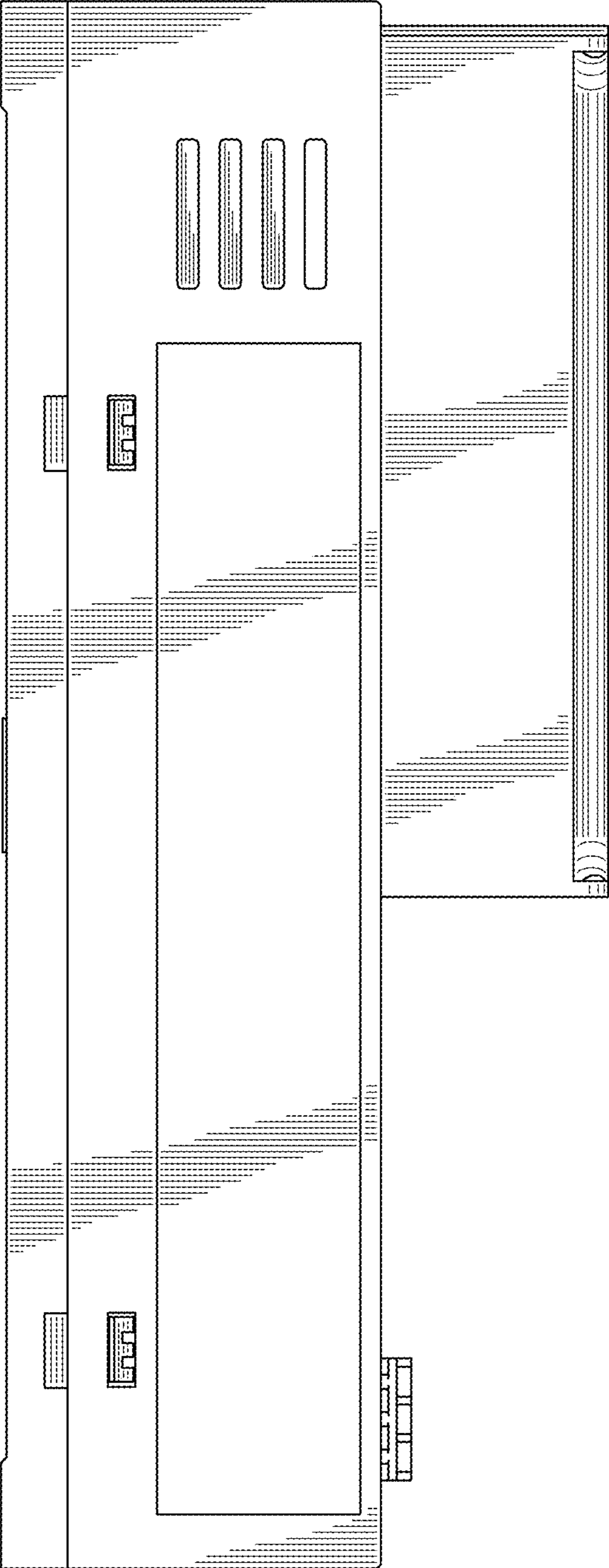

FIG. 6

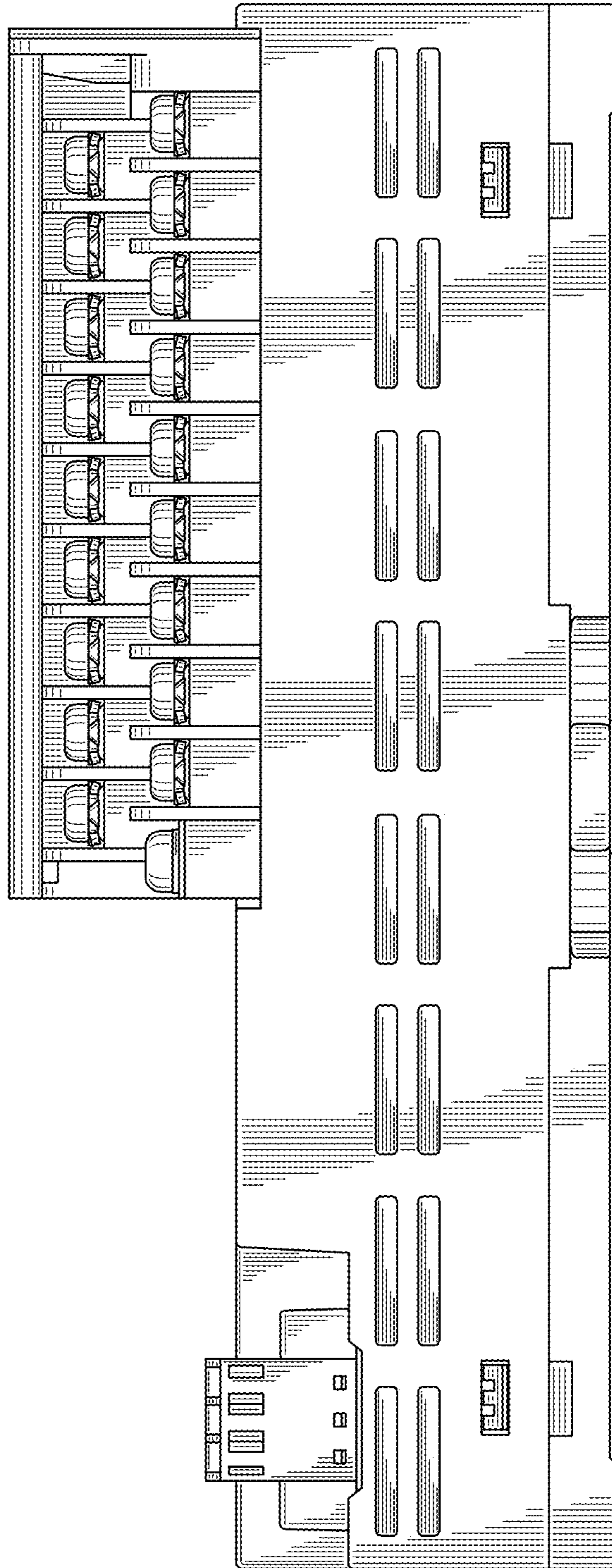

FIG. 7

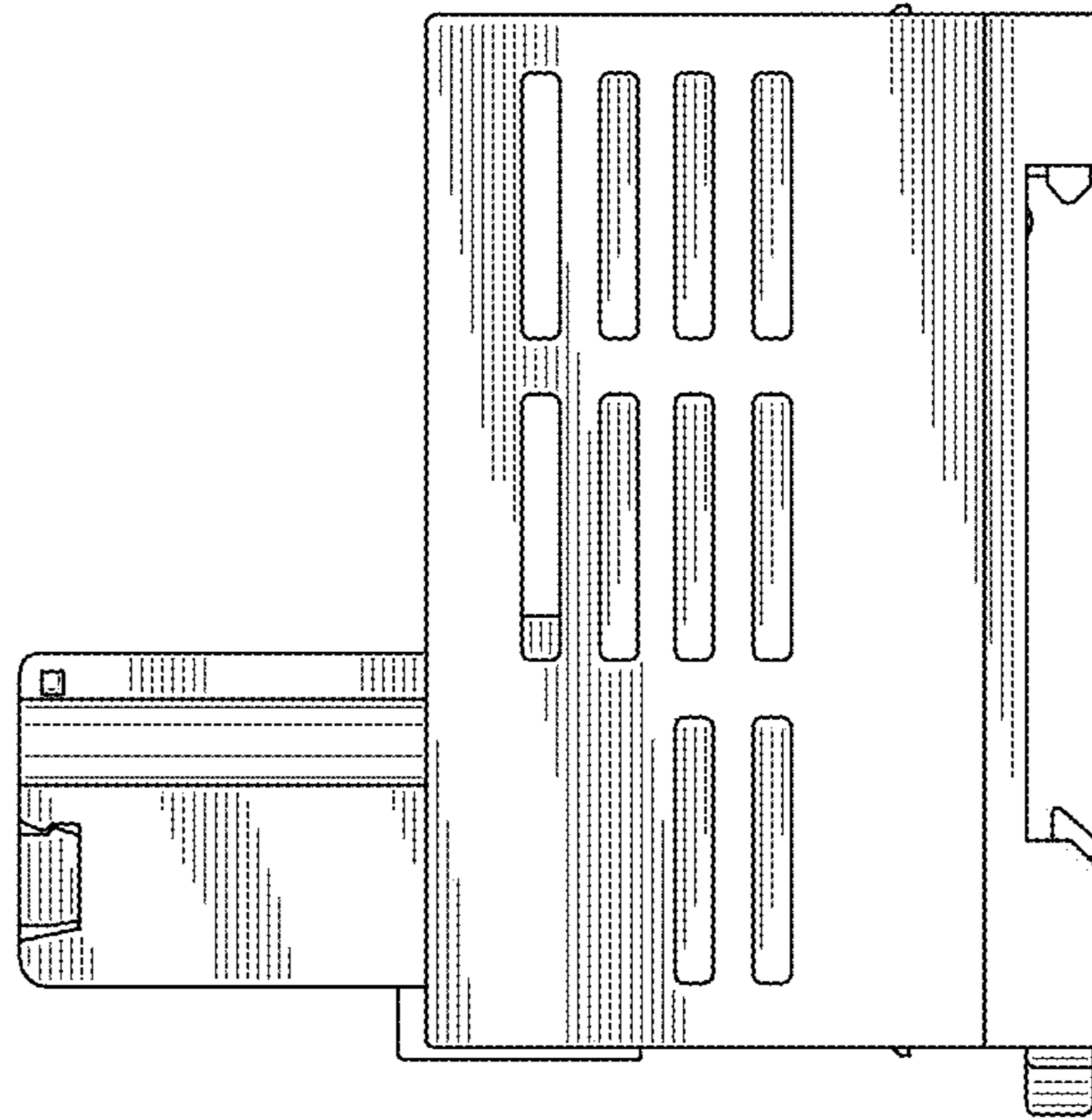

FIG. 8

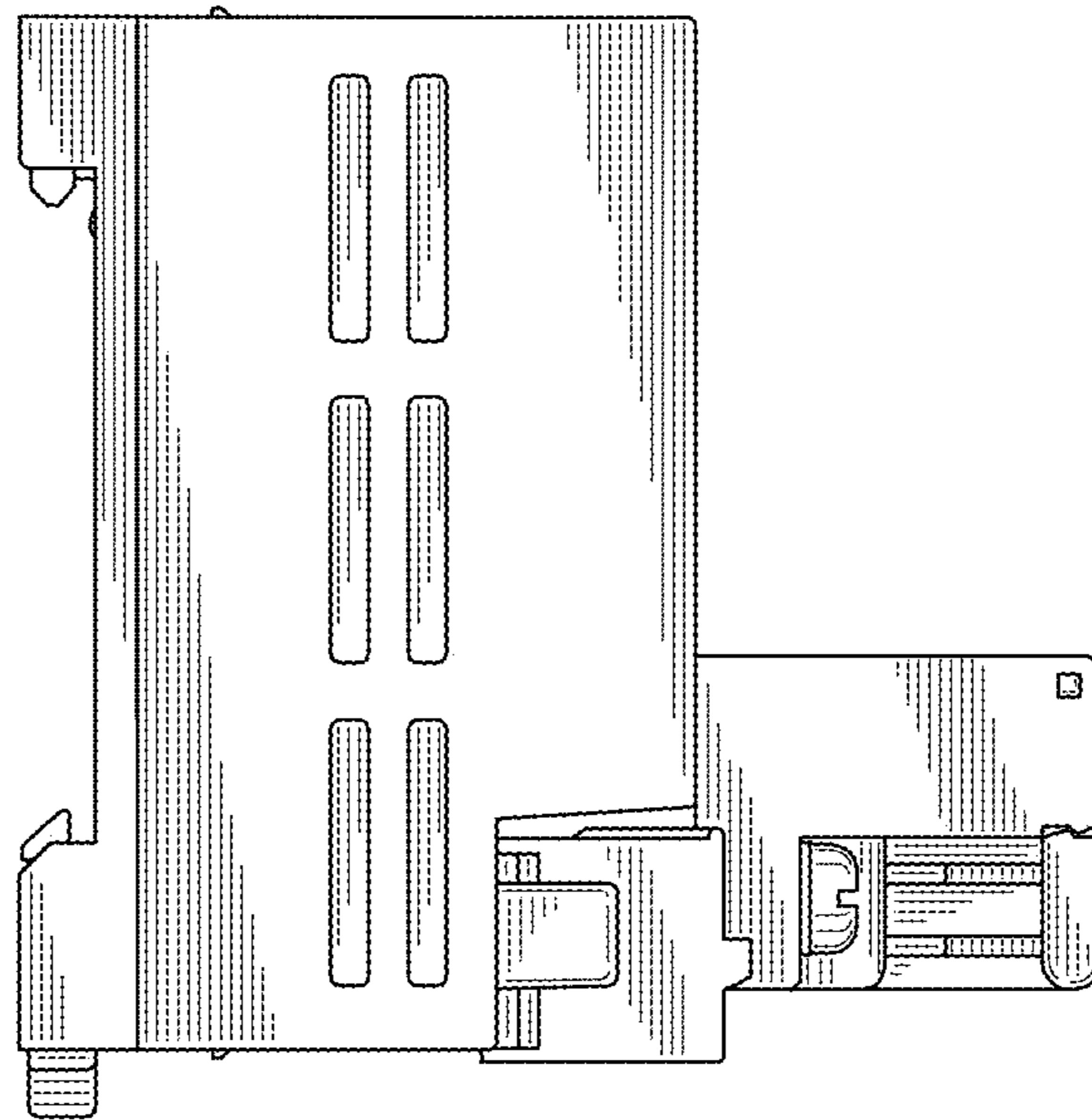

FIG. 9

