



US00D920805S

(12) **United States Design Patent**
Hawry et al.

(10) **Patent No.:** **US D920,805 S**
(45) **Date of Patent:** **** Jun. 1, 2021**

(54) **CONTAINER WITH PUMP ACTUATOR**

DESCRIPTION

(71) Applicant: **Berlin Packaging, LLC**, Chicago, IL (US)
(72) Inventors: **Liam Hawry**, Chicago, IL (US); **Brett Niggel**, Chicago, IL (US)
(73) Assignee: **Berlin Packaging, LLC**, Chicago, IL (US)
(**) Term: **15 Years**
(21) Appl. No.: **29/693,060**
(22) Filed: **May 30, 2019**
(51) **LOC (13) Cl.** **09-01**
(52) **U.S. Cl.**
USPC **D9/689**
(58) **Field of Classification Search**
USPC D9/501, 503, 504, 505, 682, 684, 686,
D9/688-692; D28/76, 77, 86, 88, 89,
D28/91.1

(Continued)

(56) **References Cited**

U.S. PATENT DOCUMENTS

D111,591 S * 10/1938 Rosenberg D28/91.1
D215,698 S * 10/1969 Jordan et al. D9/688
(Continued)

FOREIGN PATENT DOCUMENTS

CN 301740726 * 11/2011
CN 303529085 * 12/2015
(Continued)

Primary Examiner — Catherine A Tuttle

(74) *Attorney, Agent, or Firm* — Adam K. Sacharoff;
Much Shelist, P.C.

(57) **CLAIM**

The ornamental design for the container with pump actuator,
as shown and described.

FIG. 1 is a top, right and front perspective view showing our new design for a container with a pump actuator illustrated in a locked position;
FIG. 2 is a top, left and rear perspective view thereof;
FIG. 3 is a top and front perspective view thereof
FIG. 4 is a bottom and rear perspective view thereof;
FIG. 5 is a front elevation view thereof;
FIG. 6 is a rear elevation view thereof;
FIG. 7 is a left side elevation view thereof;
FIG. 8 is a front and left elevation view thereof;
FIG. 9 is a right side view thereof;
FIG. 10 is a top plan view thereof;
FIG. 11 is a bottom plan view thereof;
FIG. 12 is a top, right and front perspective view shown illustrated in an unlocked and unpressed position;
FIG. 13 is a top, left and rear perspective view thereof;
FIG. 14 is a top, front and left perspective view thereof;
FIG. 15 is a bottom, left and front perspective view thereof;
FIG. 16 is a front elevation view thereof;
FIG. 17 is a rear elevation view thereof;
FIG. 18 is a left side elevation view thereof;
FIG. 19 is a front and left elevation view thereof;
FIG. 20 is a right side view thereof;
FIG. 21 is a top plan view thereof; and
FIG. 22 is a bottom plan view thereof.
FIG. 23 is a top, right and front perspective view shown in an unlocked and depressed position;
FIG. 24 is a top, left and rear perspective view thereof;
FIG. 25 is a top, front and left perspective view thereof;
FIG. 26 is a bottom, left and front perspective view thereof;
FIG. 27 is a front elevation view thereof;
FIG. 28 is a rear elevation view thereof;
FIG. 29 is a left side elevation view thereof;
FIG. 30 is an a front and left elevation view thereof;
FIG. 31 is a right side view thereof;
FIG. 32 is a top plan view thereof; and,
FIG. 33 is a bottom plan view thereof.
The dashed lice circle shown in FIGS. 4, 11, 15, 22, 26, and 33 depicts a portion of the container with pump actuator that forms no part of the claimed design.

1 Claim, 33 Drawing Sheets

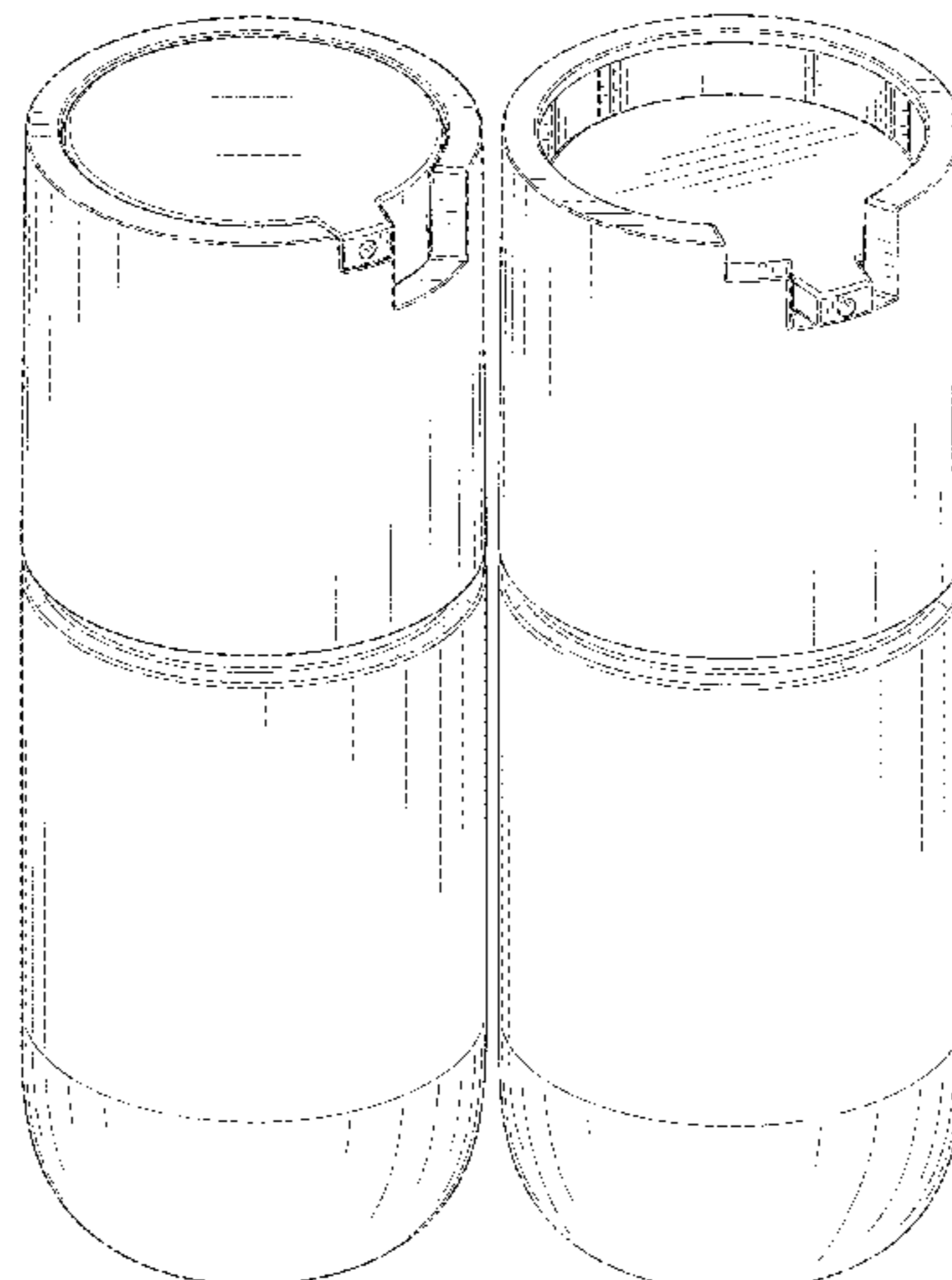

(58) **Field of Classification Search**

CPC .. B05B 11/00-3098; B65D 83/14-759; A45D 34/00; A45D 34/02; A45D 34/04; A45D 34/06; A45D 2034/002; A45D 2034/005; A45D 2034/007; A45D 2200/054-058; A45D 40/00; A45D 40/26

See application file for complete search history.

(56) **References Cited**

U.S. PATENT DOCUMENTS

3,484,023 A 12/1969 Meshberg
 4,162,746 A 7/1979 Anderson et al.
 4,572,410 A 2/1986 Brunet
 4,836,423 A 6/1989 Hayes et al.
 4,848,595 A 7/1989 Foster et al.
 4,889,262 A 12/1989 Toms
 4,991,746 A 2/1991 Schultz
 5,115,980 A 5/1992 Skorka
 D327,009 S * 6/1992 Poore D9/503
 5,314,093 A 5/1994 Gross et al.
 5,335,830 A 8/1994 Cater
 5,388,730 A 2/1995 Abbott et al.
 5,445,299 A 8/1995 Harriman
 D365,020 S * 12/1995 Dinand D9/503
 5,772,080 A 6/1998 De Pous et al.
 5,878,916 A 3/1999 Dejonge
 5,899,363 A 5/1999 Bliss, III et al.
 6,196,423 B1 3/2001 Erxleben
 6,604,656 B1 8/2003 Tseng
 6,691,896 B2 2/2004 Meshberg
 6,932,244 B2 8/2005 Meshberg
 7,014,068 B1 3/2006 Cohen et al.
 7,168,594 B2 1/2007 Law et al.
 D561,024 S 2/2008 Altonen et al.
 7,510,101 B2 3/2009 Foster et al.
 D608,655 S 1/2010 Brewer et al.
 D613,614 S 4/2010 Rodriguez et al.
 7,735,688 B2 6/2010 Foster et al.
 7,775,402 B2 8/2010 Yoshida et al.
 7,874,461 B2 1/2011 Bae
 D661,192 S * 6/2012 Hwang D9/504
 8,292,124 B2 10/2012 Guenther
 8,292,532 B2 10/2012 Nasu et al.
 8,308,029 B2 11/2012 Ki
 8,439,230 B2 5/2013 Hagen
 8,490,837 B2 7/2013 Michaux et al.
 D696,962 S 1/2014 Chen
 D699,047 S 2/2014 Lissoni
 8,662,775 B1 3/2014 Liu
 8,695,852 B2 4/2014 Bertin et al.
 D704,070 S * 5/2014 Pires D9/689
 D708,524 S * 7/2014 White D9/504
 8,777,061 B1 7/2014 Meshberg
 8,863,988 B2 10/2014 Kang
 D721,283 S * 1/2015 Lawrance D9/689
 8,978,933 B2 3/2015 Muller et al.
 9,010,581 B2 4/2015 Presche
 D736,095 S * 8/2015 Brochado D9/689
 9,180,475 B2 11/2015 Cho
 9,186,689 B2 11/2015 Kim
 D750,885 S * 3/2016 Chazel D3/203.2
 9,277,797 B2 3/2016 Chen
 D758,879 S 6/2016 Chen
 9,598,225 B2 3/2017 Patil et al.

9,745,117 B2 8/2017 Kim et al.
 9,789,502 B2 10/2017 Maddy
 9,839,929 B2 12/2017 Deman
 9,894,980 B2 2/2018 Kim
 D812,486 S * 3/2018 Newson D9/690
 9,937,509 B2 4/2018 Dejong
 9,937,511 B2 4/2018 Goettke
 10,010,897 B2 7/2018 Espinoza
 10,138,971 B1 11/2018 Deman et al.
 10,220,401 B2 3/2019 Puviland et al.
 10,232,393 B2 3/2019 Dumont et al.
 D891,867 S * 8/2020 Faria D7/510
 2003/0010793 A1 1/2003 Ritsche
 2009/0071985 A1 * 3/2009 Ki B05B 11/0027
 222/309
 2009/0302062 A1 * 12/2009 Maddy B05B 11/3059
 222/183
 2010/0284725 A1 * 11/2010 Zhang A45D 34/042
 401/171
 2012/0282010 A1 * 11/2012 Albers A45D 34/042
 401/129
 2013/0026186 A1 * 1/2013 Jenkins B05B 11/3025
 222/153.13
 2015/0090741 A1 4/2015 Laffey
 2018/0361413 A1 12/2018 Ruan
 2019/0054486 A1 2/2019 Deman
 2019/0118205 A1 4/2019 Knight
 2019/0275827 A1 * 9/2019 Nguyen B43K 5/1818

FOREIGN PATENT DOCUMENTS

CN 107051774 A 8/2017
 CN 304649802 * 5/2018
 CN 208746628 A 4/2019
 DE 102019102718 A1 * 8/2020 B05B 11/3008
 EP 1674162 A1 4/2008
 EP 2859957 A1 4/2015
 EP 2893833 B1 9/2016
 FR 2983046 A3 3/2014
 JP 5394288 B2 1/2014
 KR 200440940 Y1 7/2008
 KR 200459801 Y1 4/2012
 KR 200470941 Y1 1/2014
 KR 300734752.0000 * 3/2014
 KR 300799586.0000 * 6/2015
 WO 2008072833 A1 6/2008
 WO 2008150810 A1 12/2008
 WO 2009030428 A1 3/2009
 WO 071390 S 9/2009
 WO 2011071301 A2 11/2011
 WO 2012074162 A1 6/2012
 WO 2012074163 A1 6/2012
 WO WO-2012074163 A1 * 6/2012 B05B 11/3059
 WO 201305976 A1 3/2013
 WO 2013068188 A1 5/2013
 WO 2014111252 A1 7/2014
 WO 2014111253 A1 7/2014
 WO 2014128007 A1 8/2014
 WO 2015143828 A1 10/2015
 WO 2017073920 A1 5/2017
 WO 2017211585 A1 12/2017
 WO 2018048998 A1 3/2018
 WO 2018126397 A1 7/2018
 WO 2018215659 A1 11/2018
 WO WO-2020061402 A1 * 3/2020 B05B 11/3008

* cited by examiner

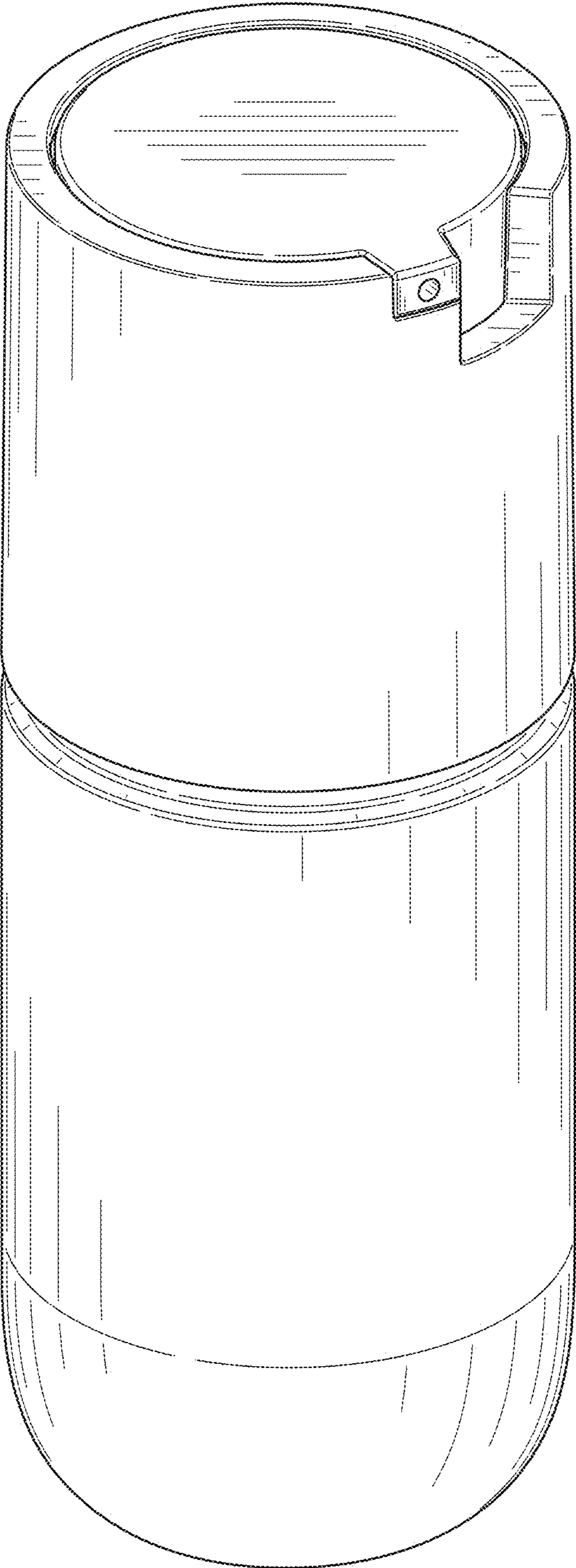

FIG. 1

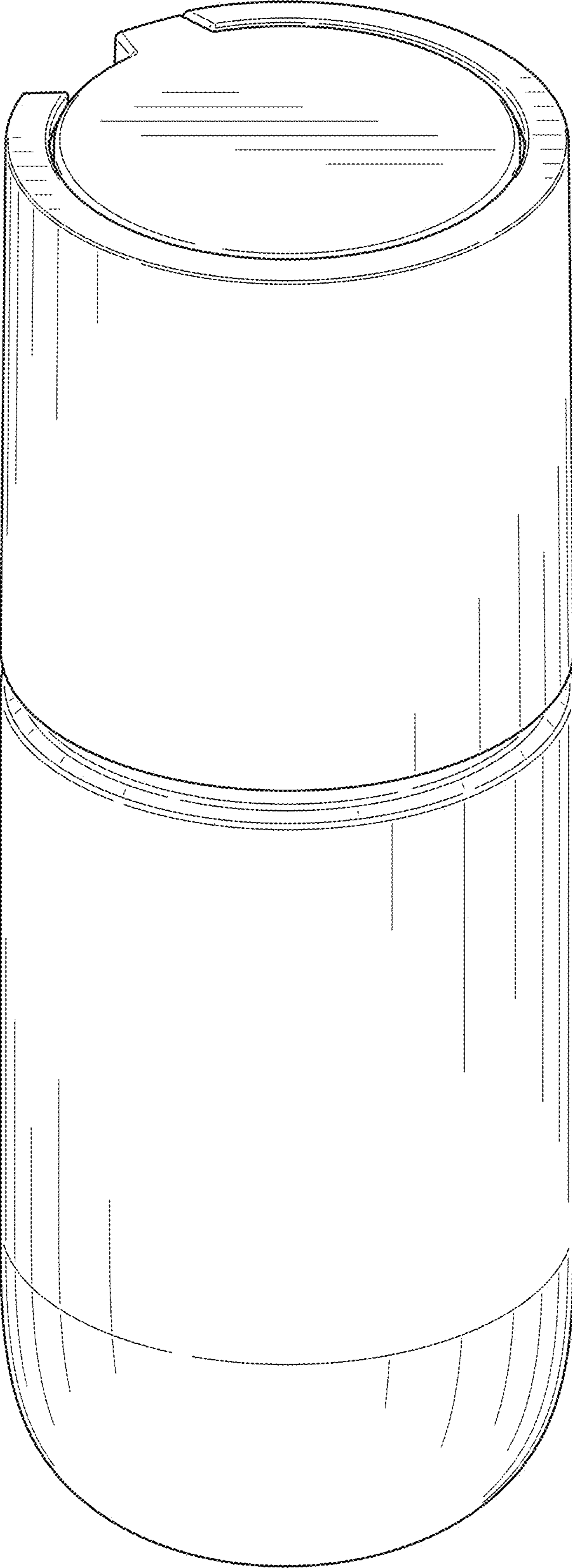

FIG. 2

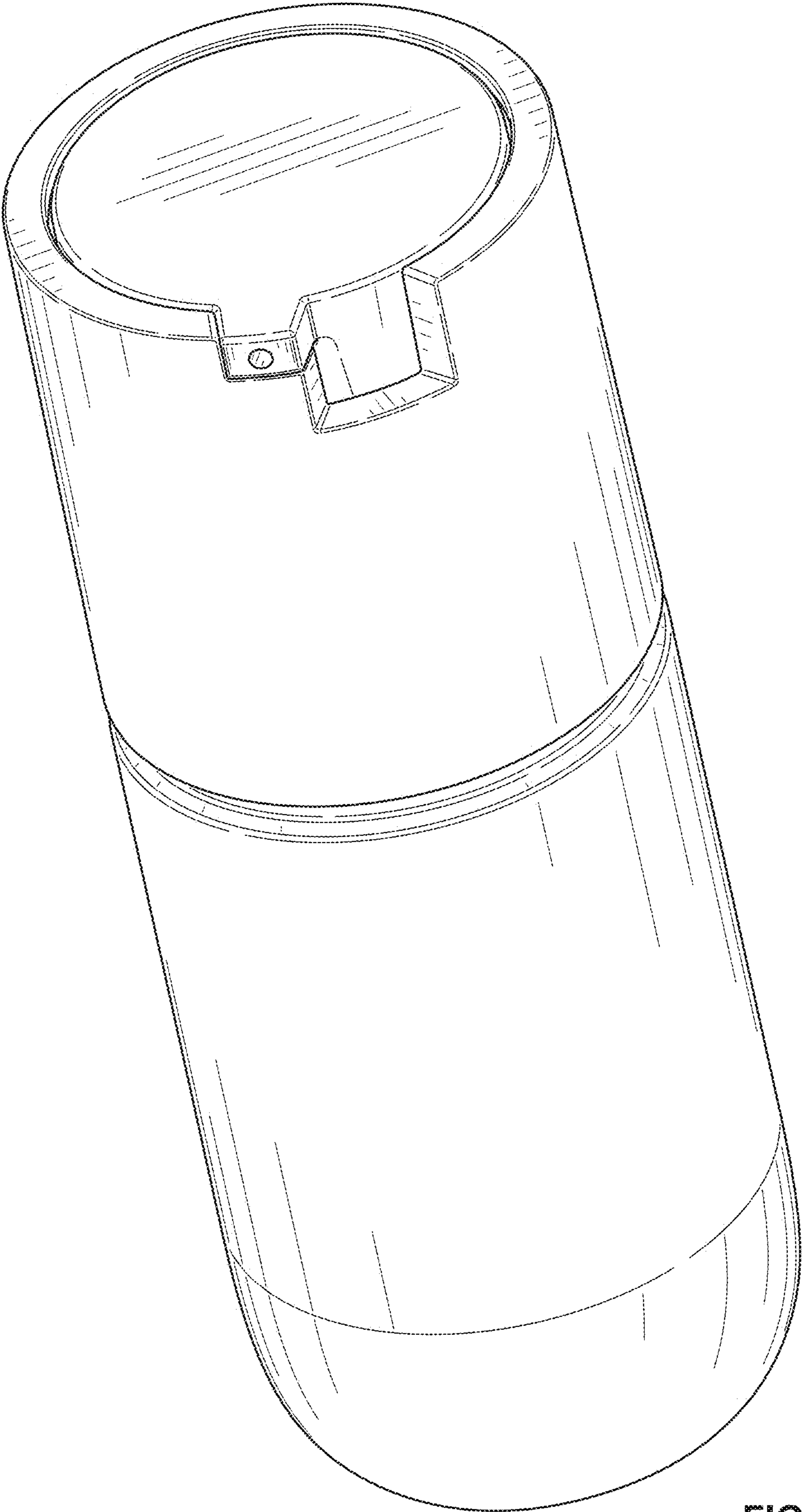

FIG. 3

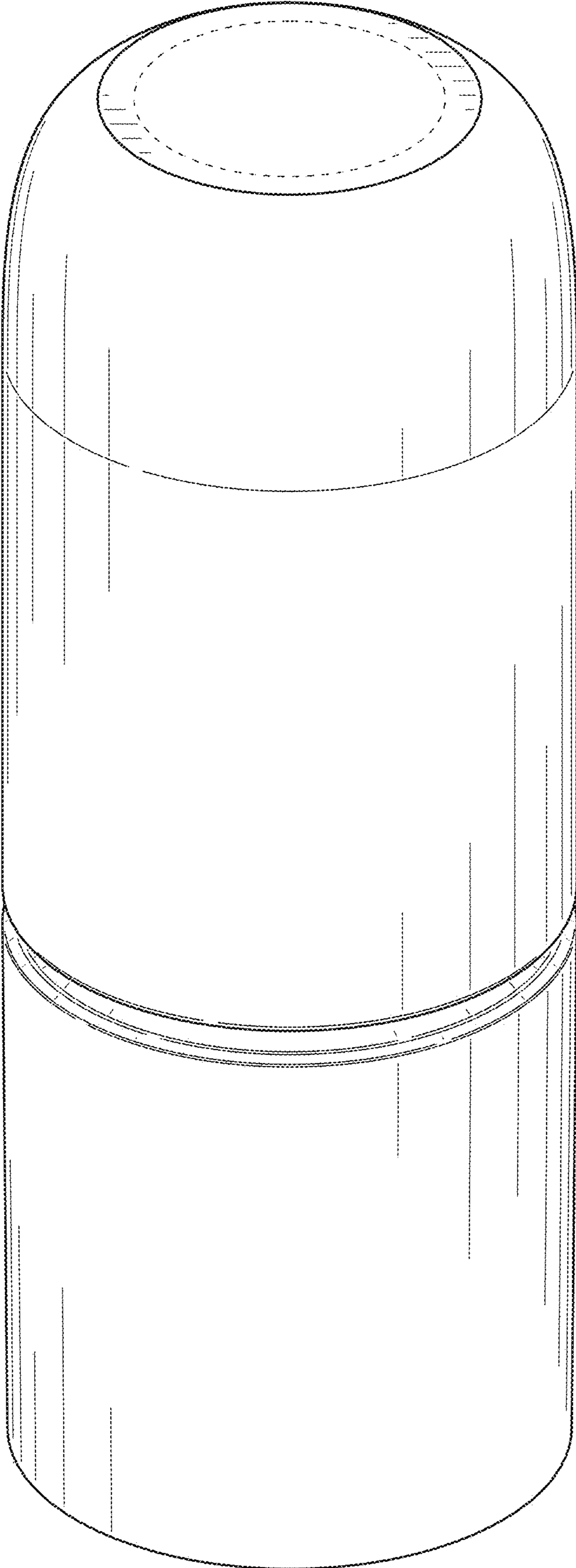

FIG. 4

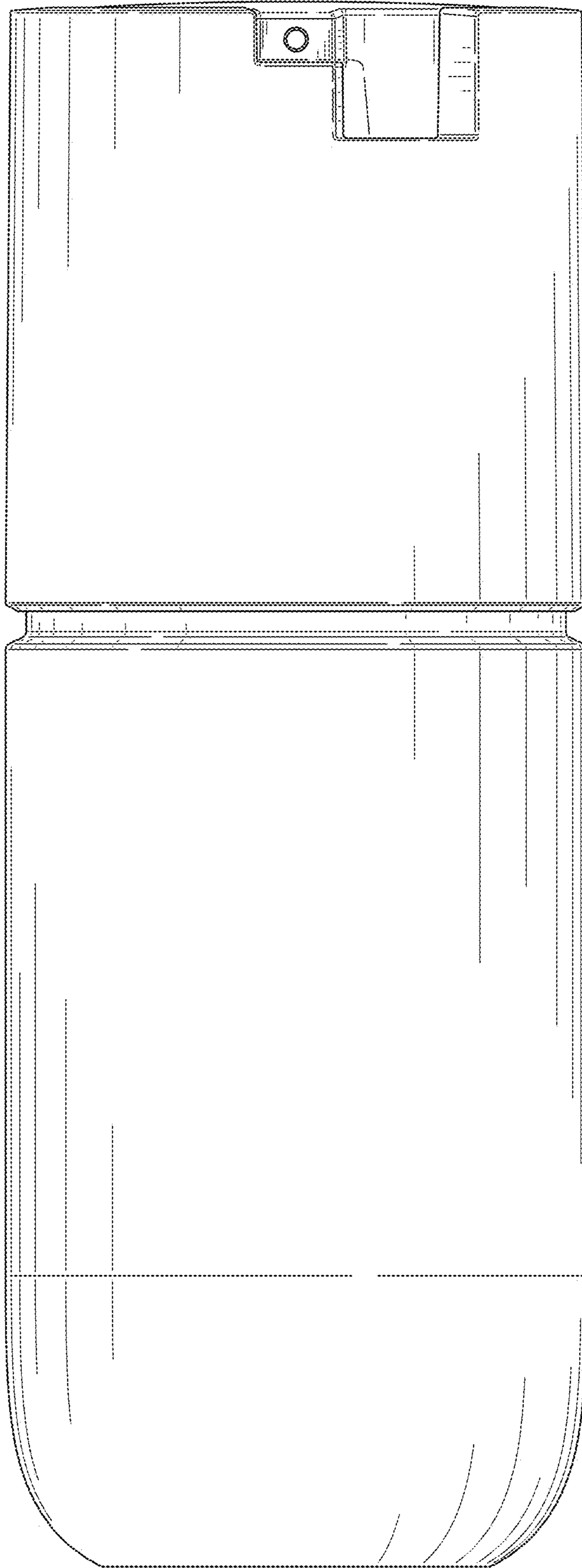

FIG. 5

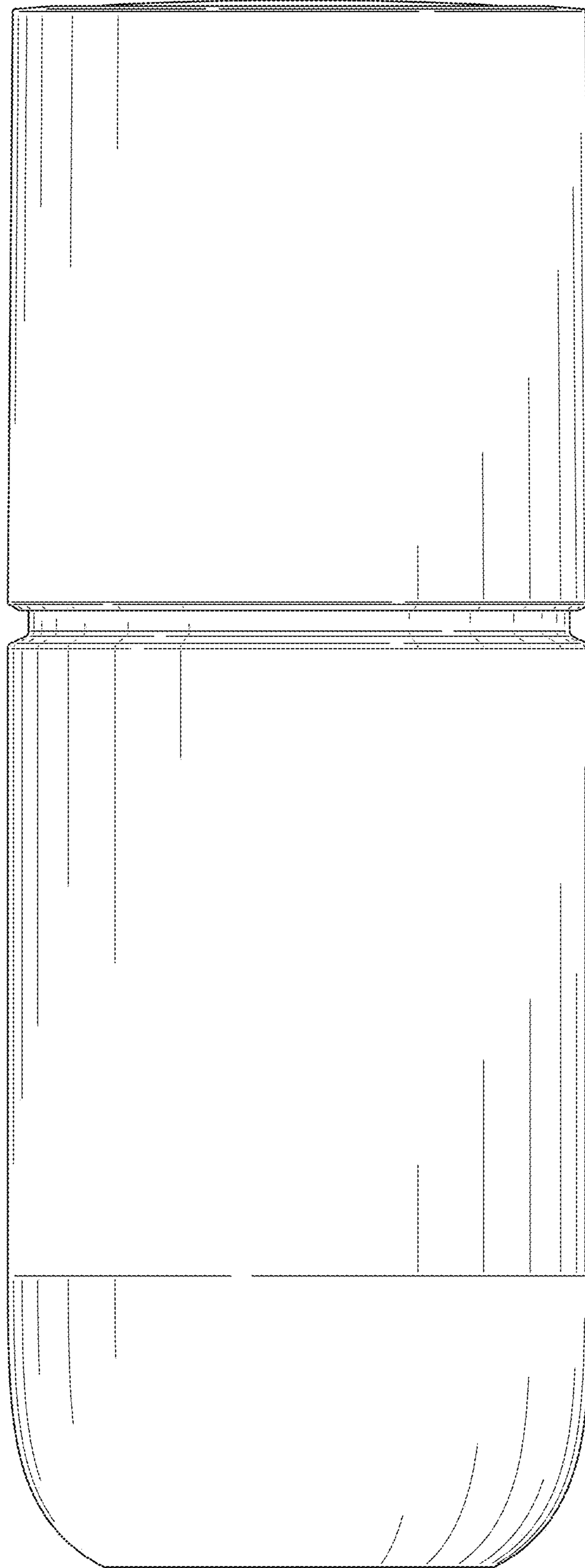

FIG. 6

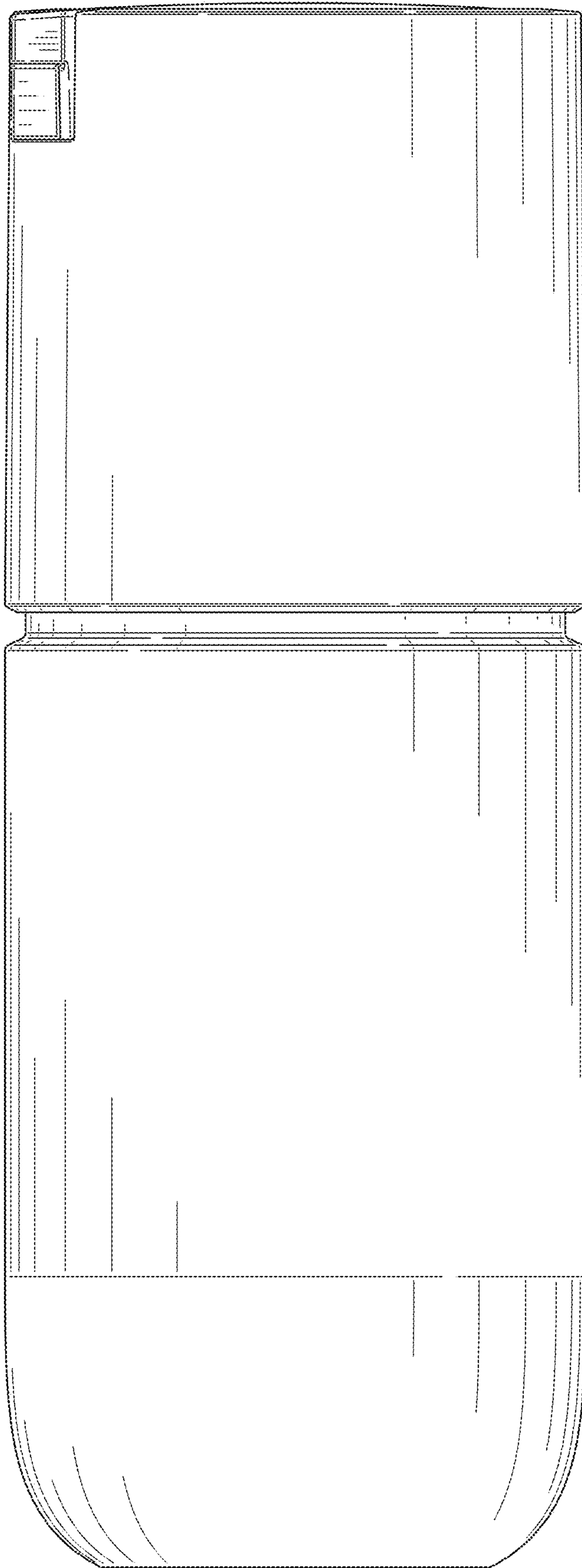

FIG. 7

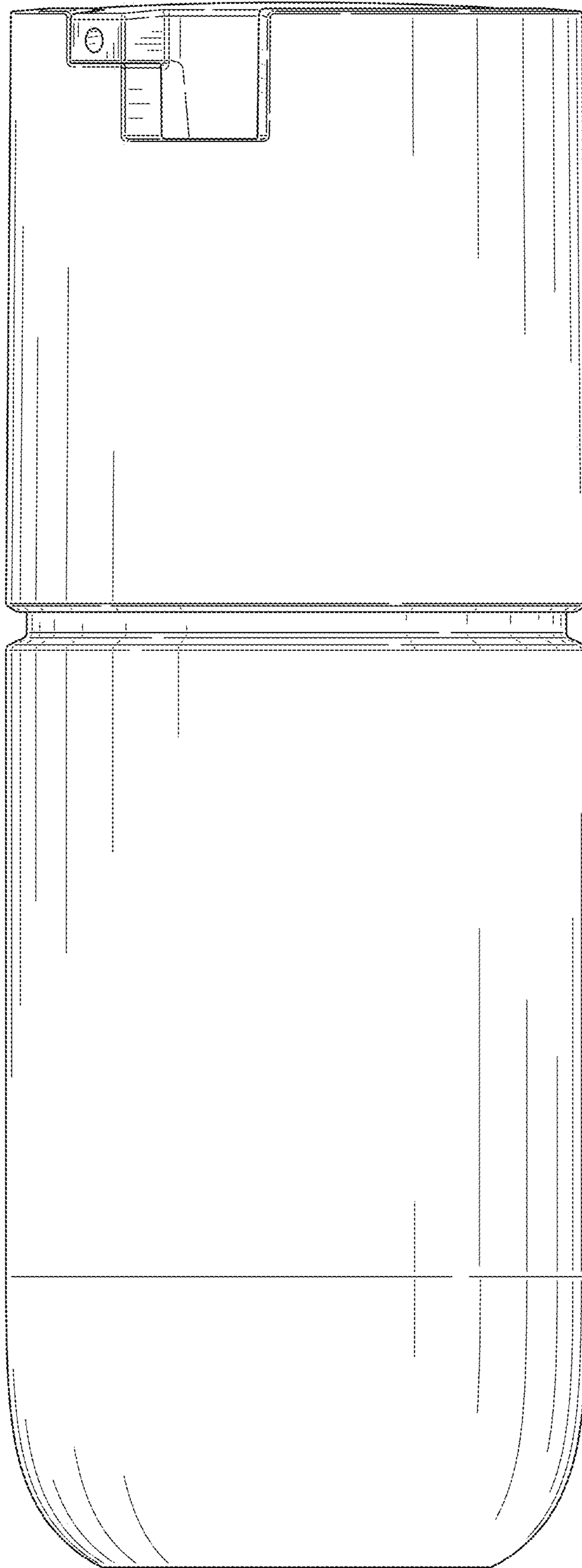

FIG. 8

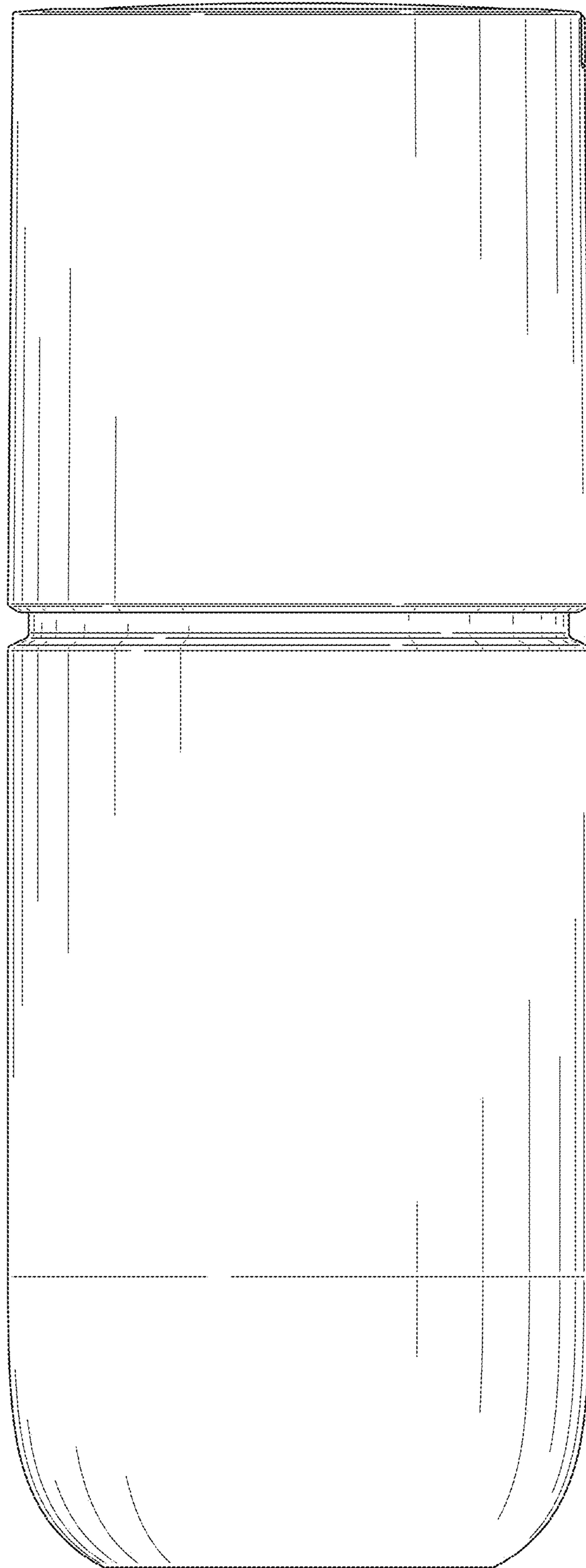

FIG. 9

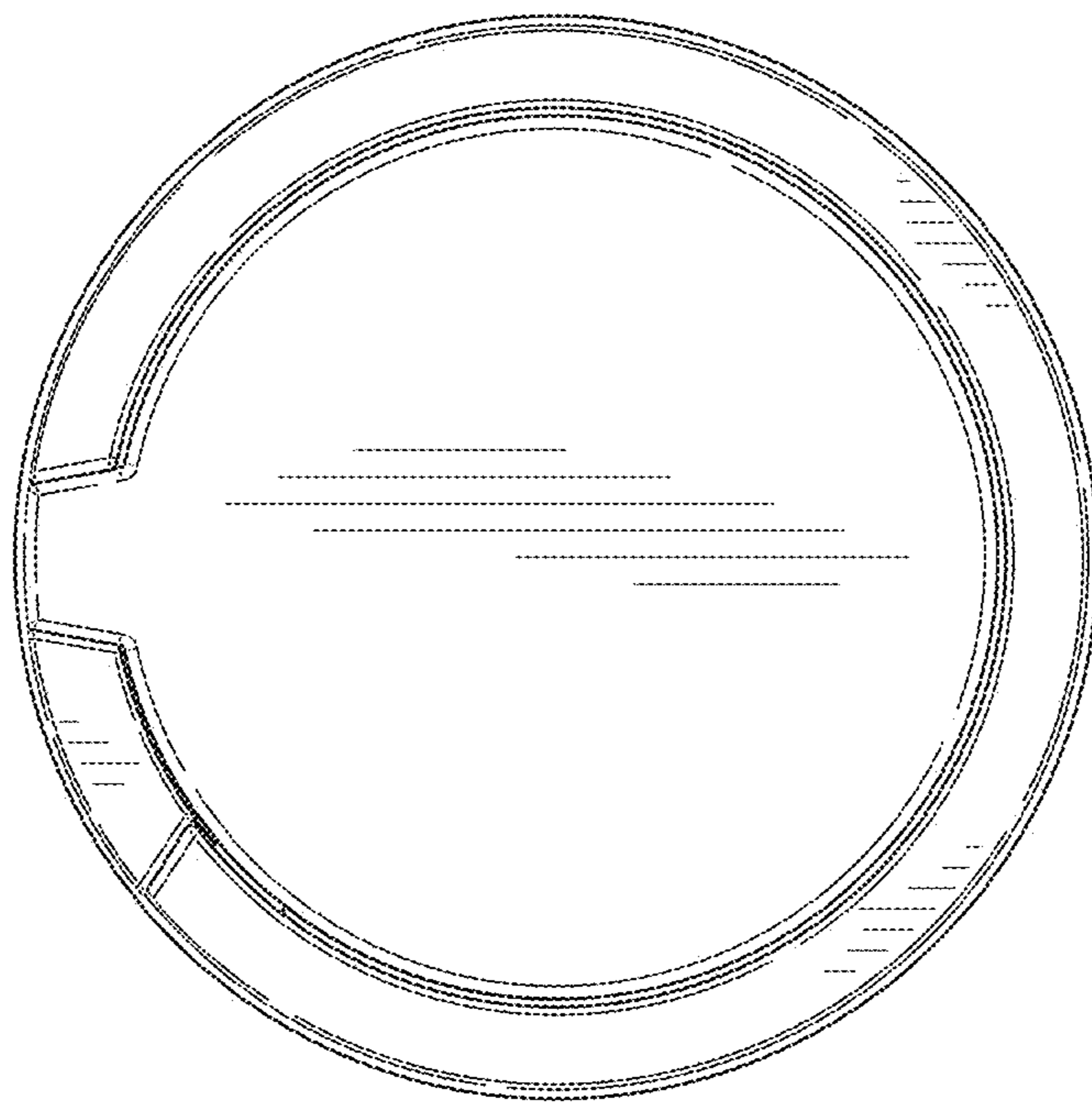

FIG. 10

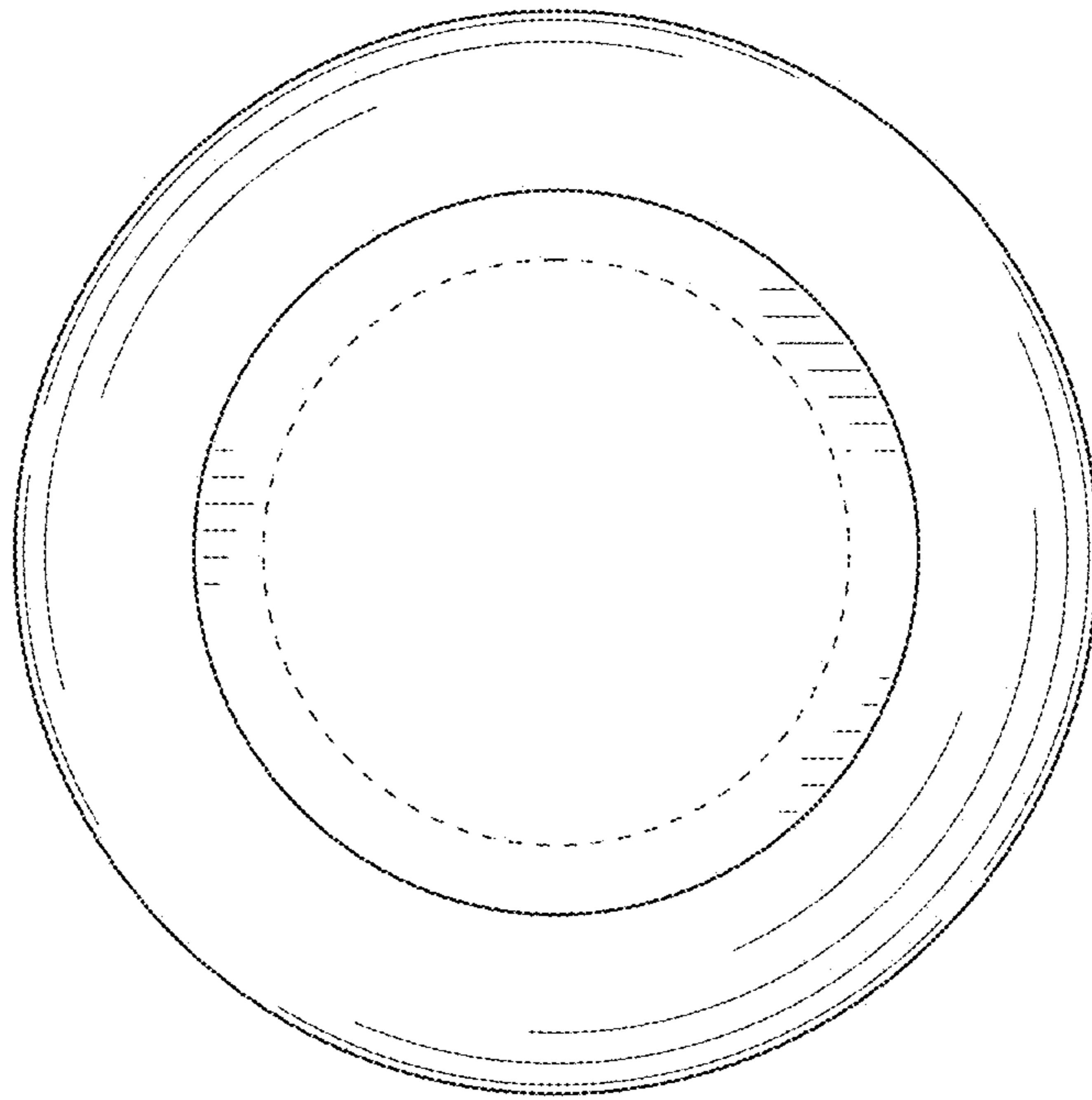

FIG. 11

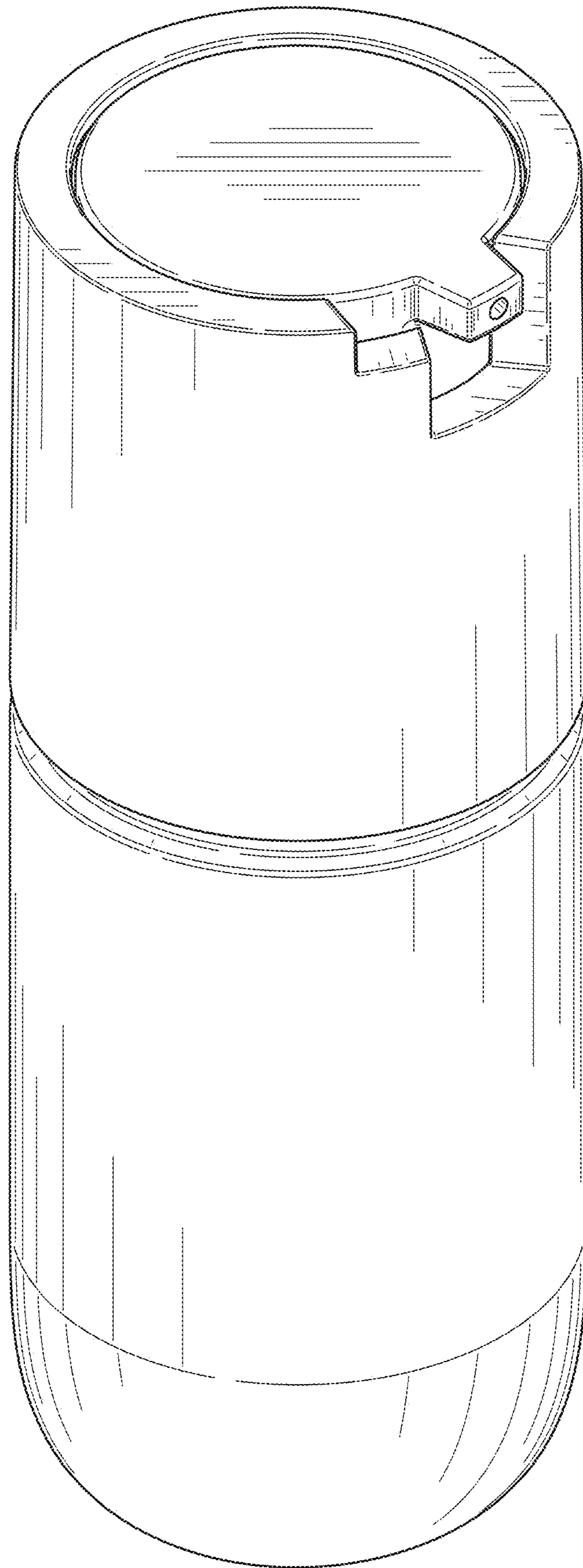

FIG. 12

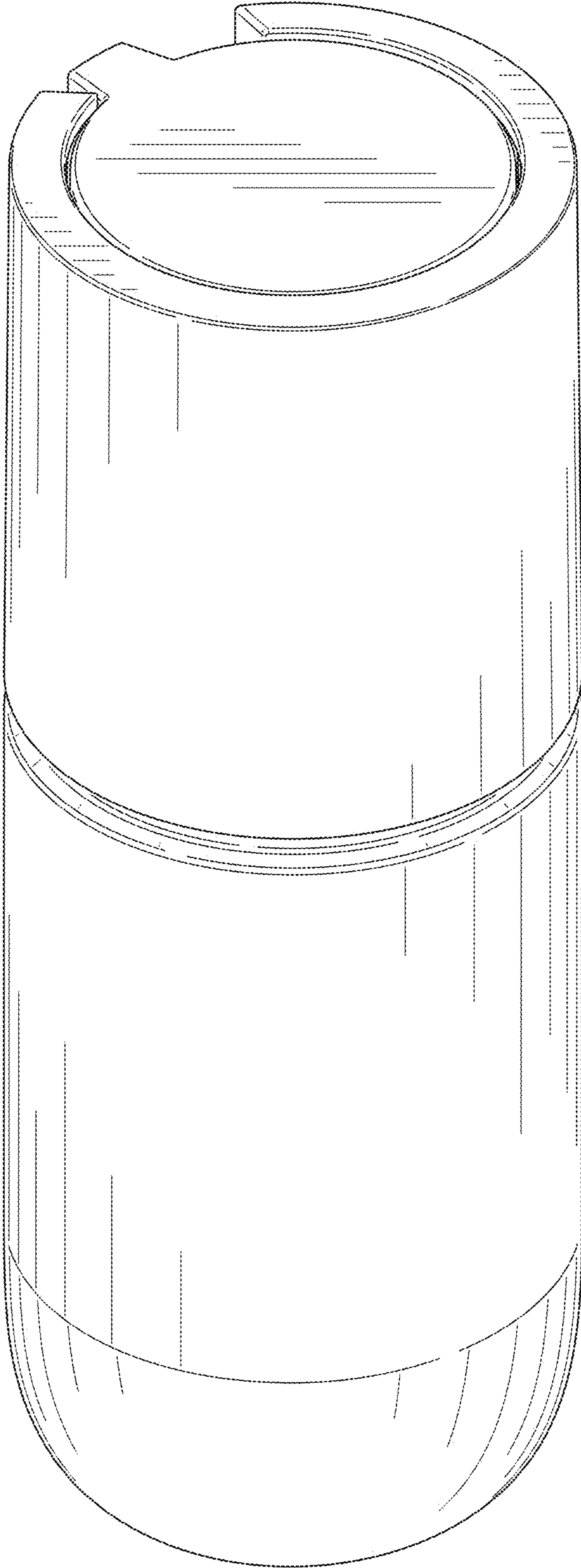

FIG. 13

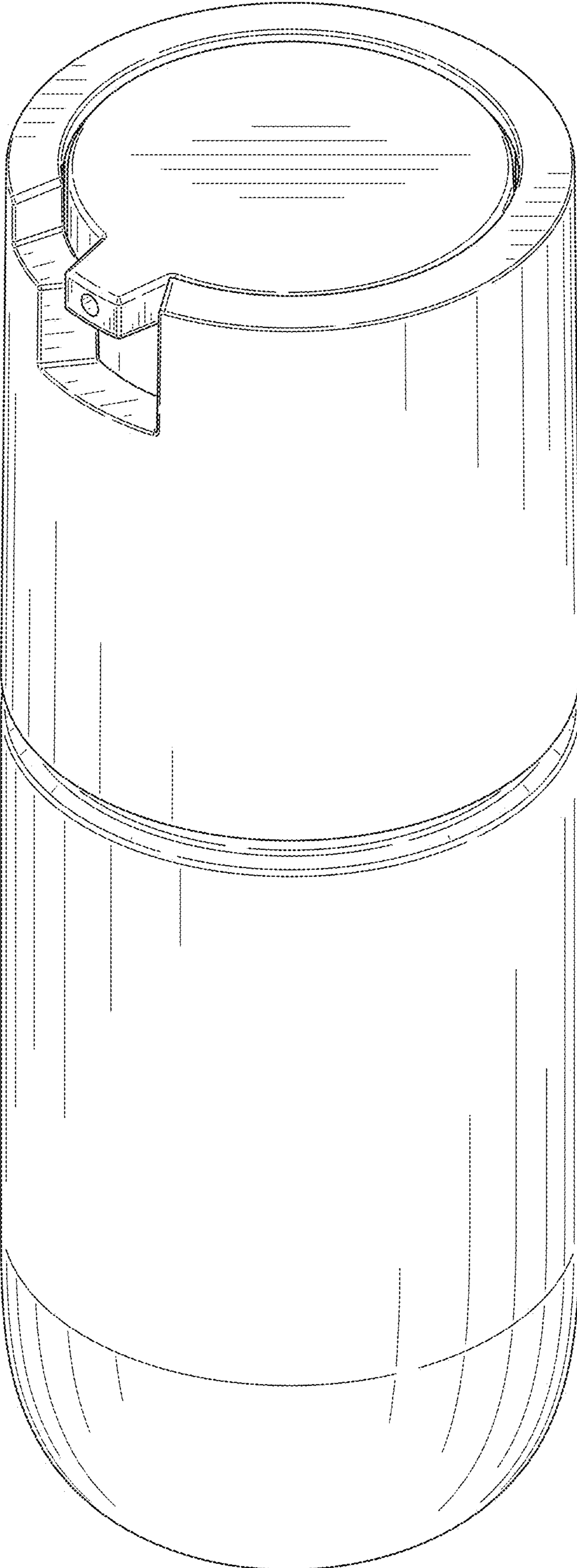

FIG. 14

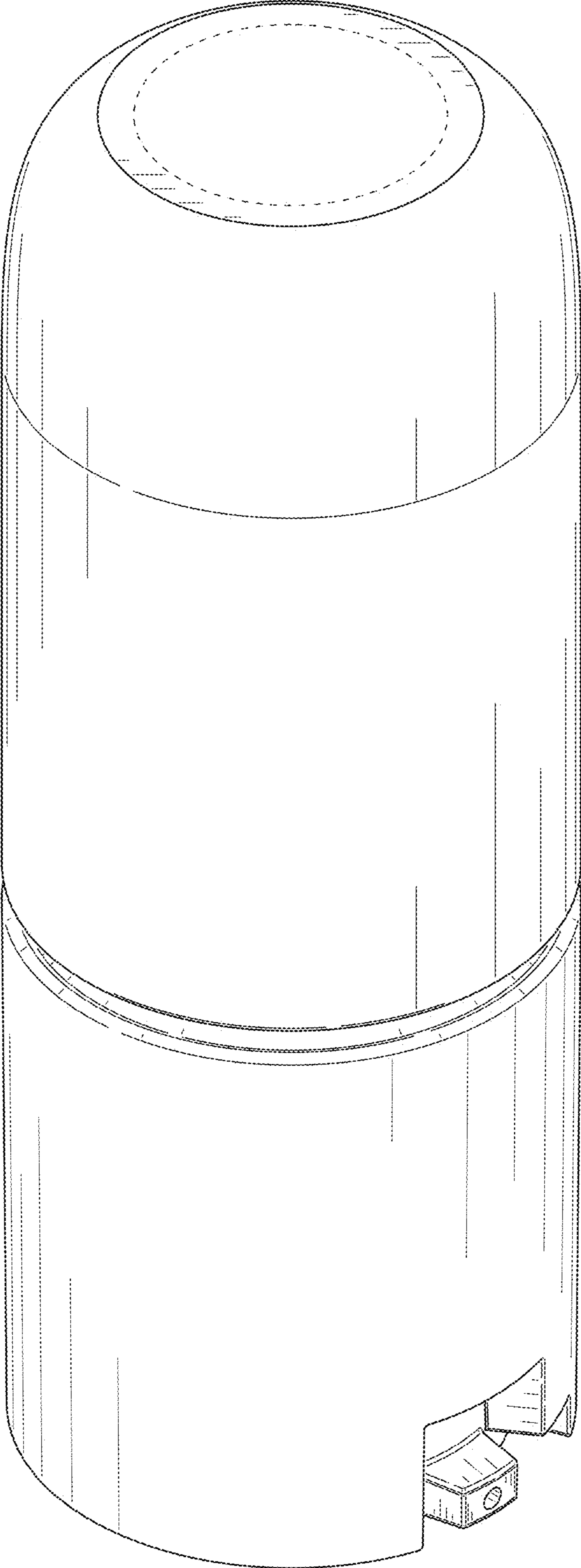

FIG. 15

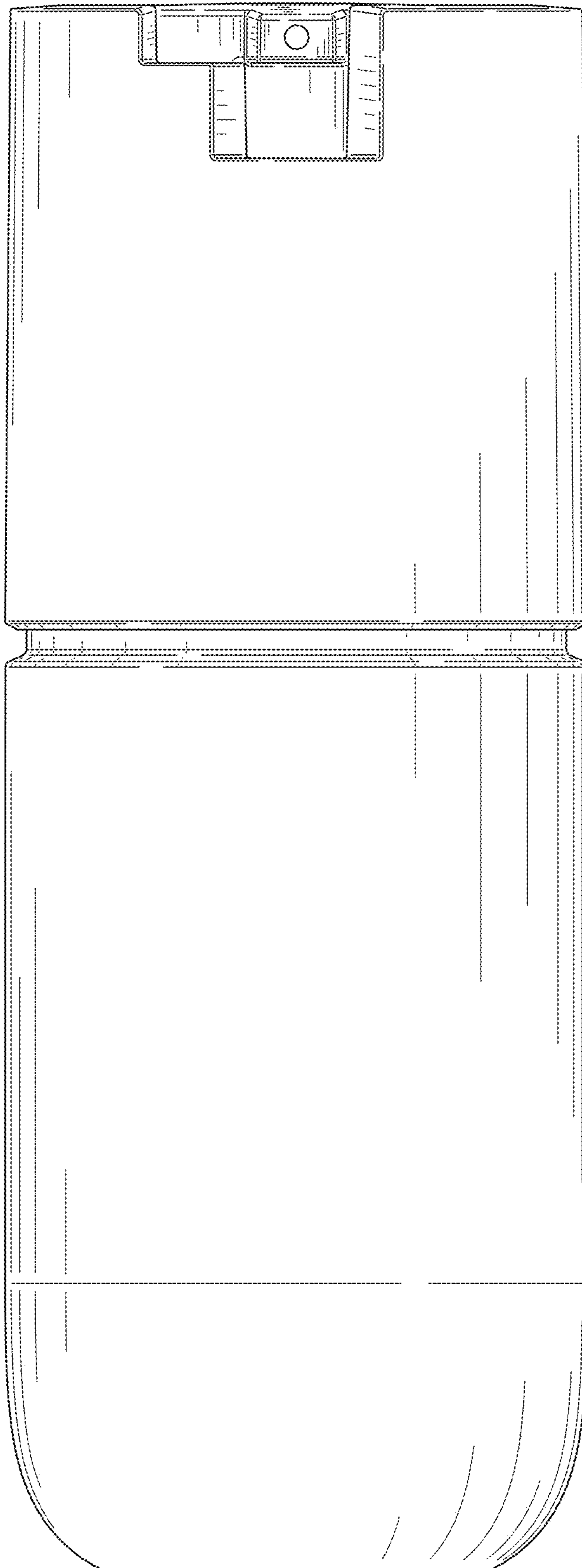

FIG. 16

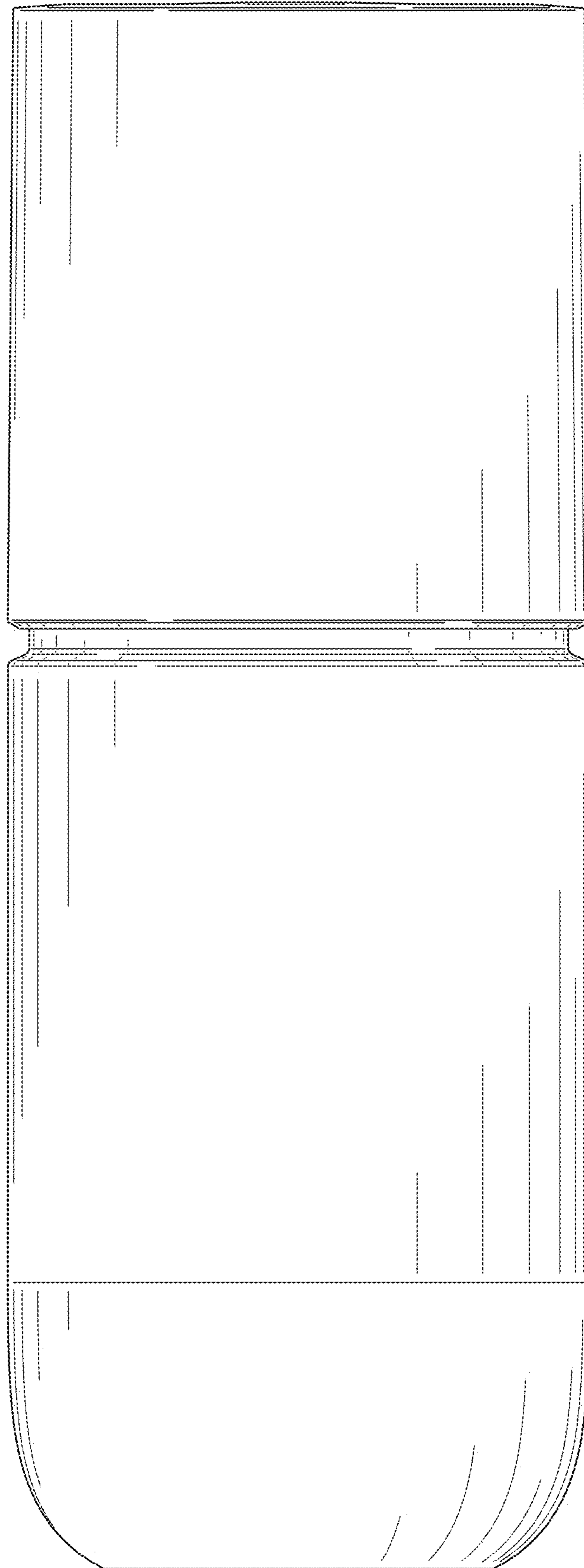

FIG. 17

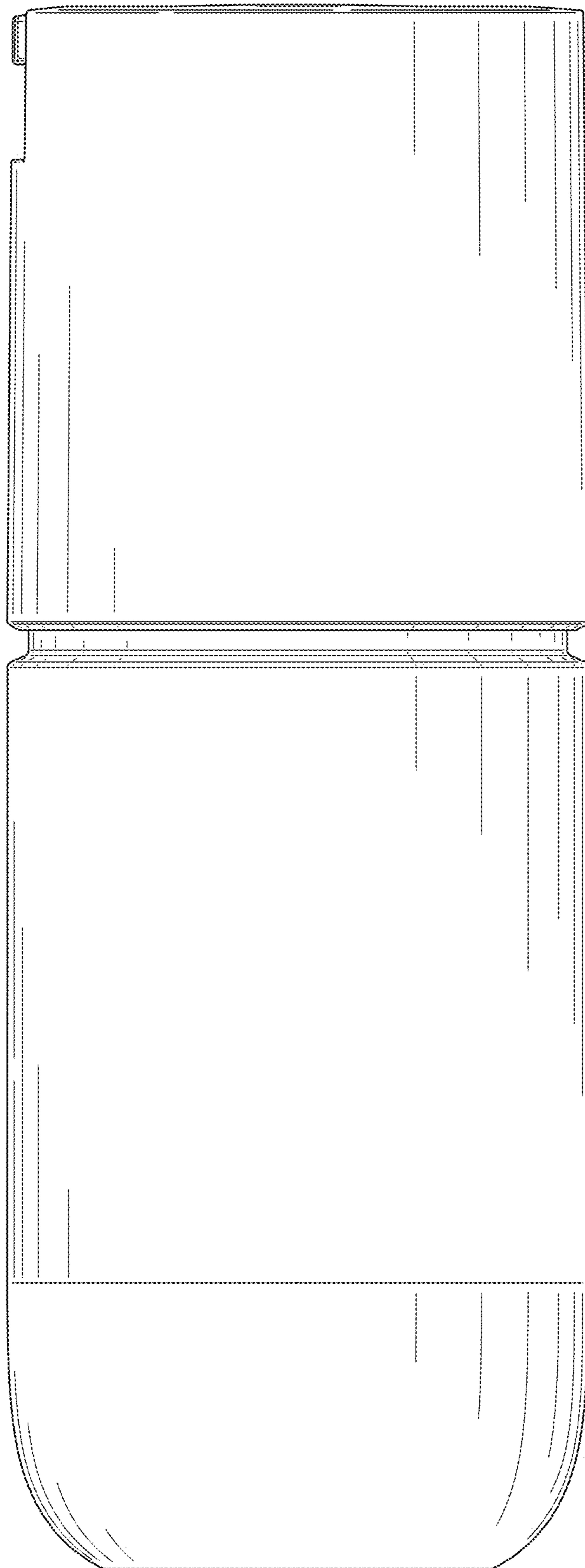

FIG. 18

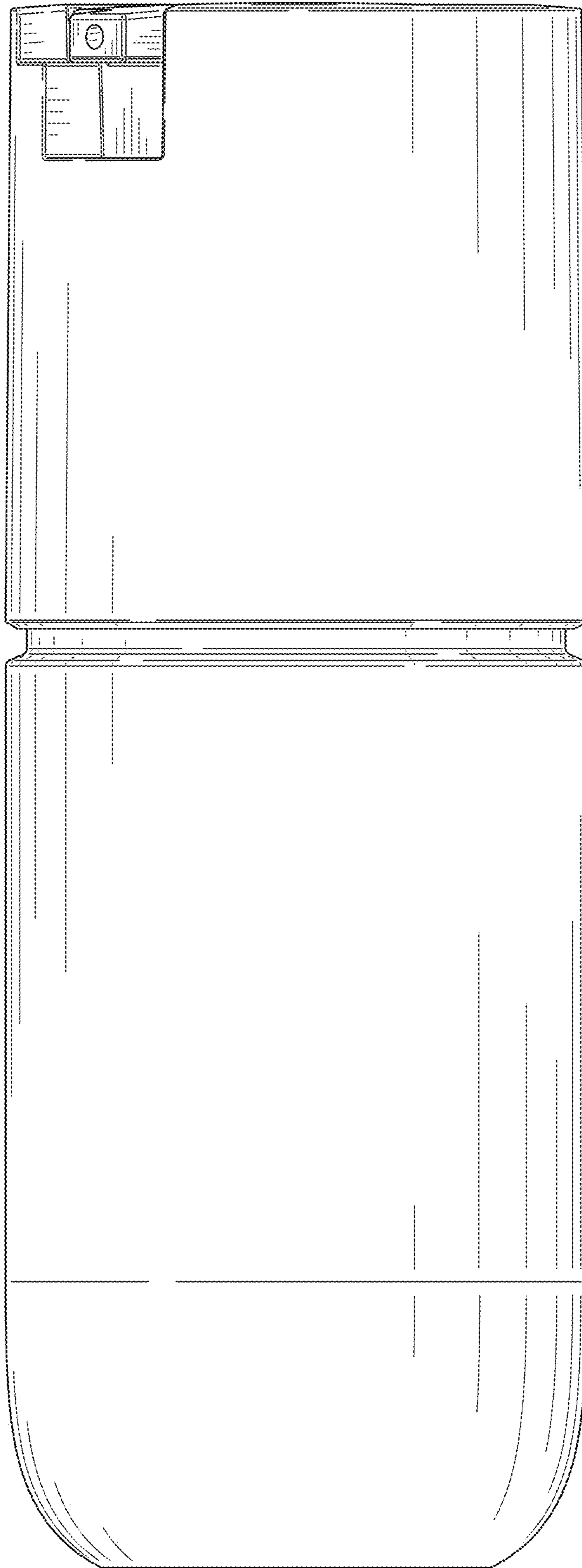

FIG. 19

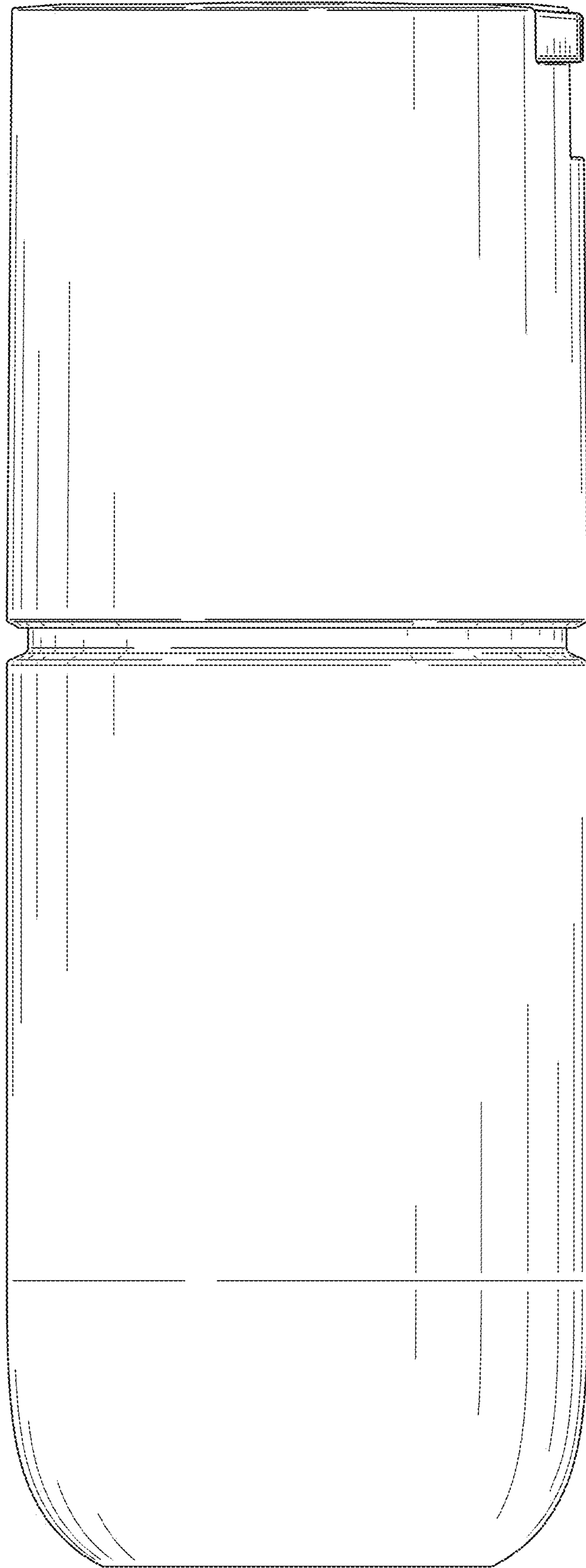

FIG. 20

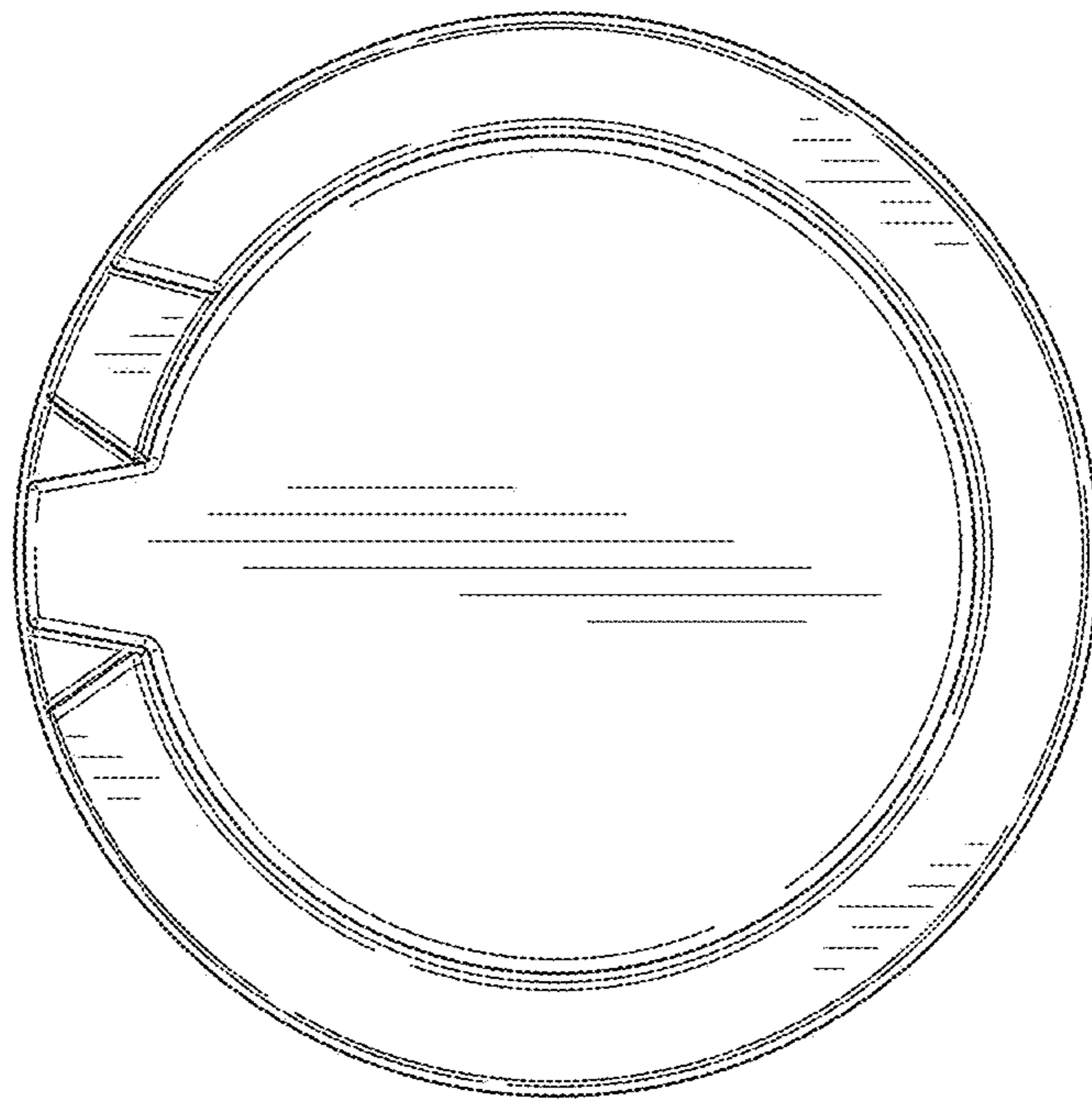

FIG. 21

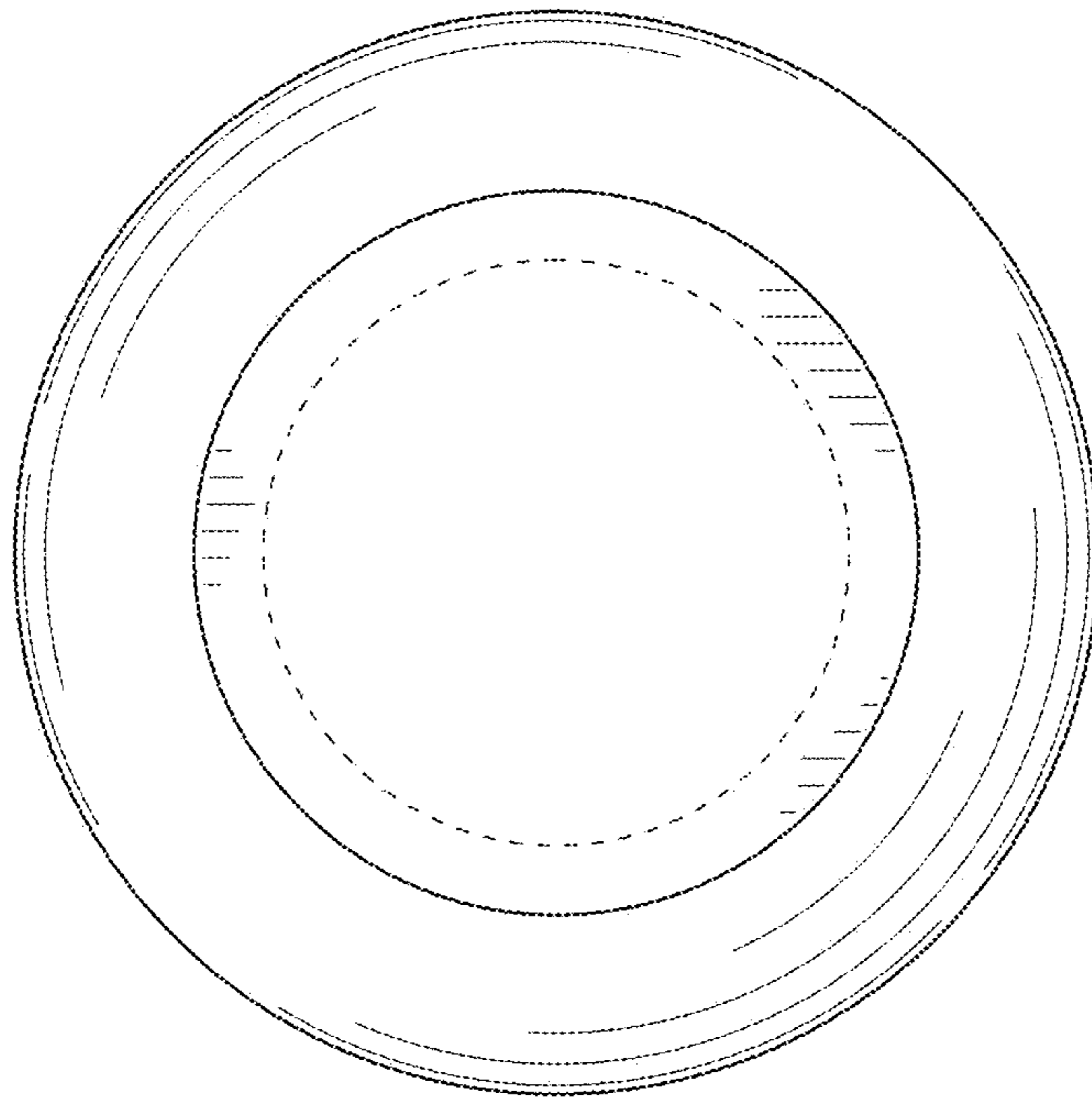

FIG. 22

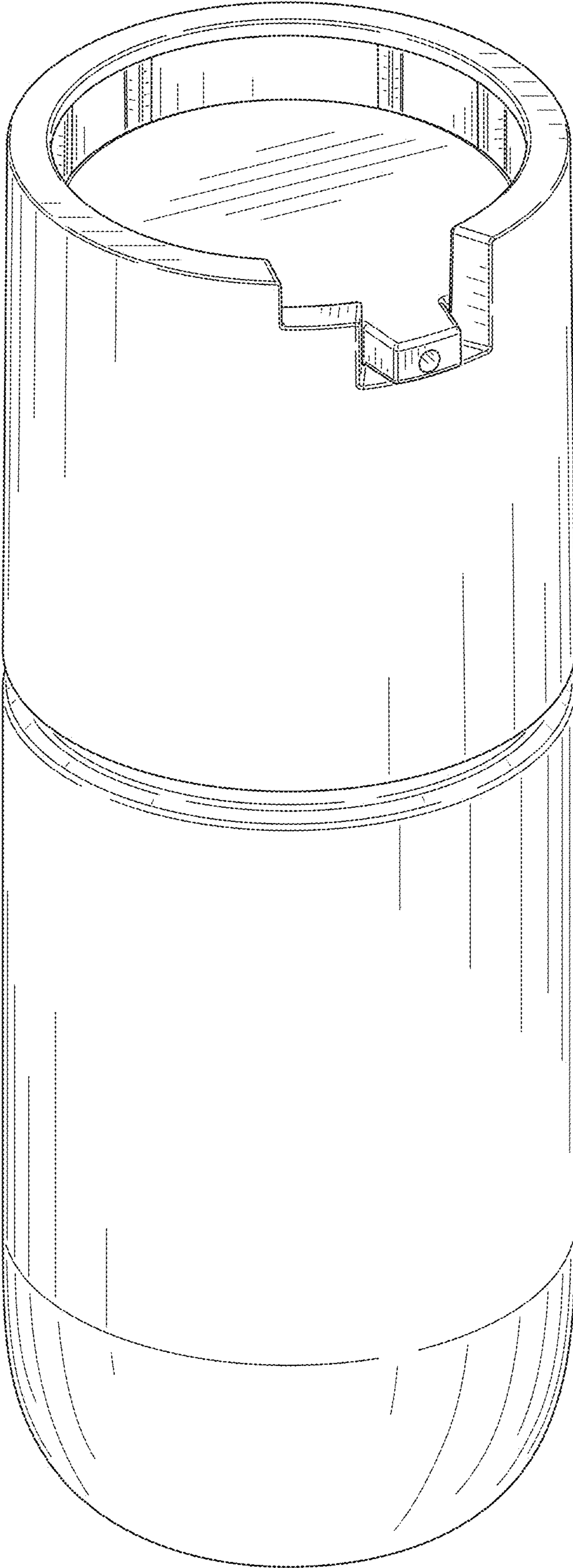

FIG. 23

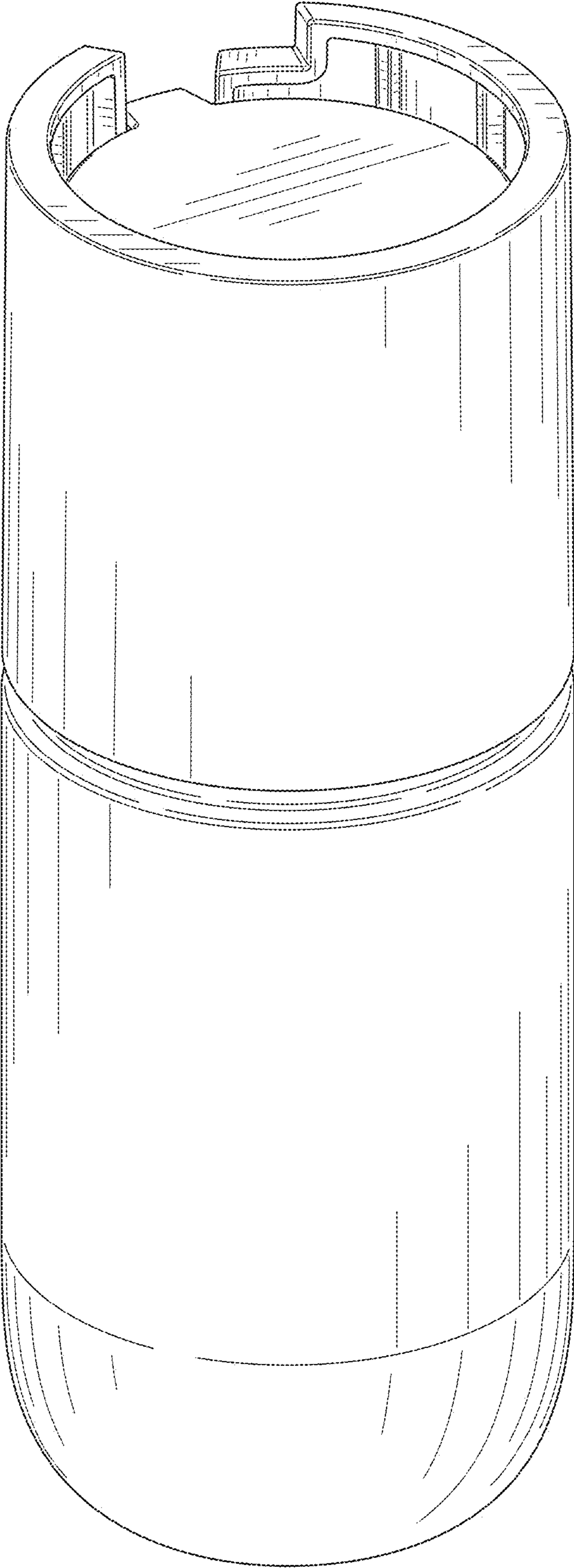

FIG. 24

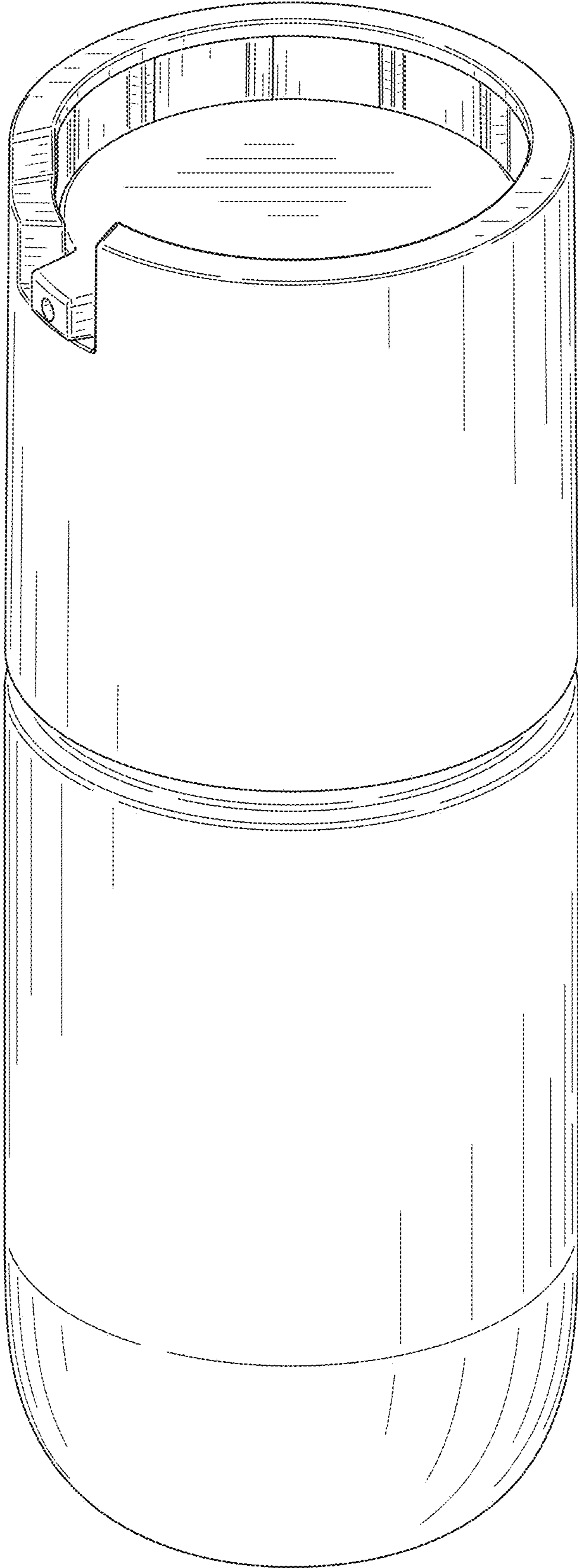

FIG. 25

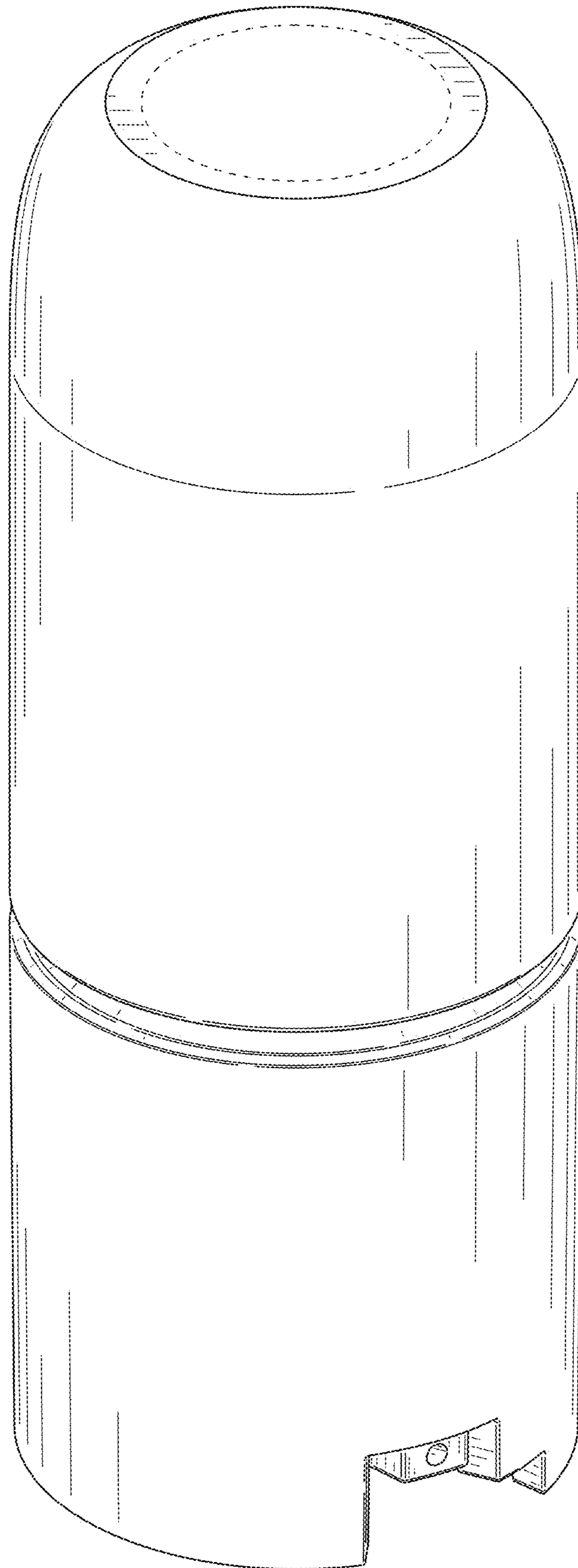

FIG. 26

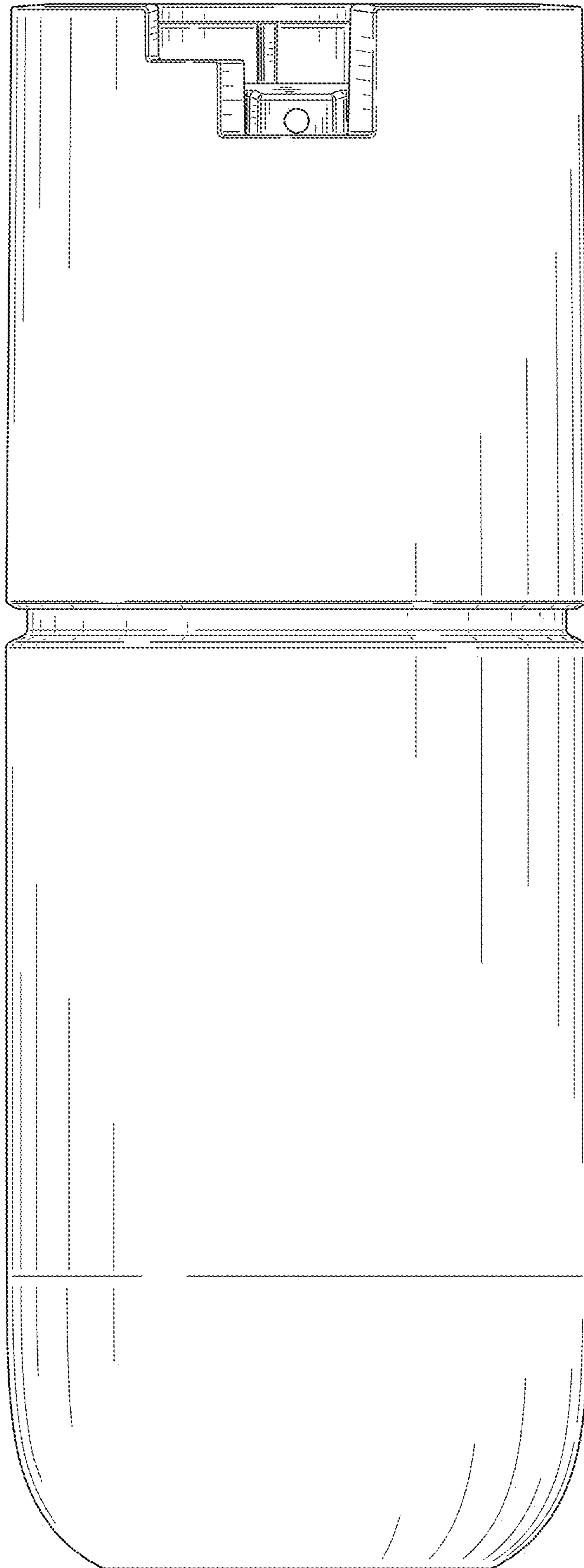

FIG. 27

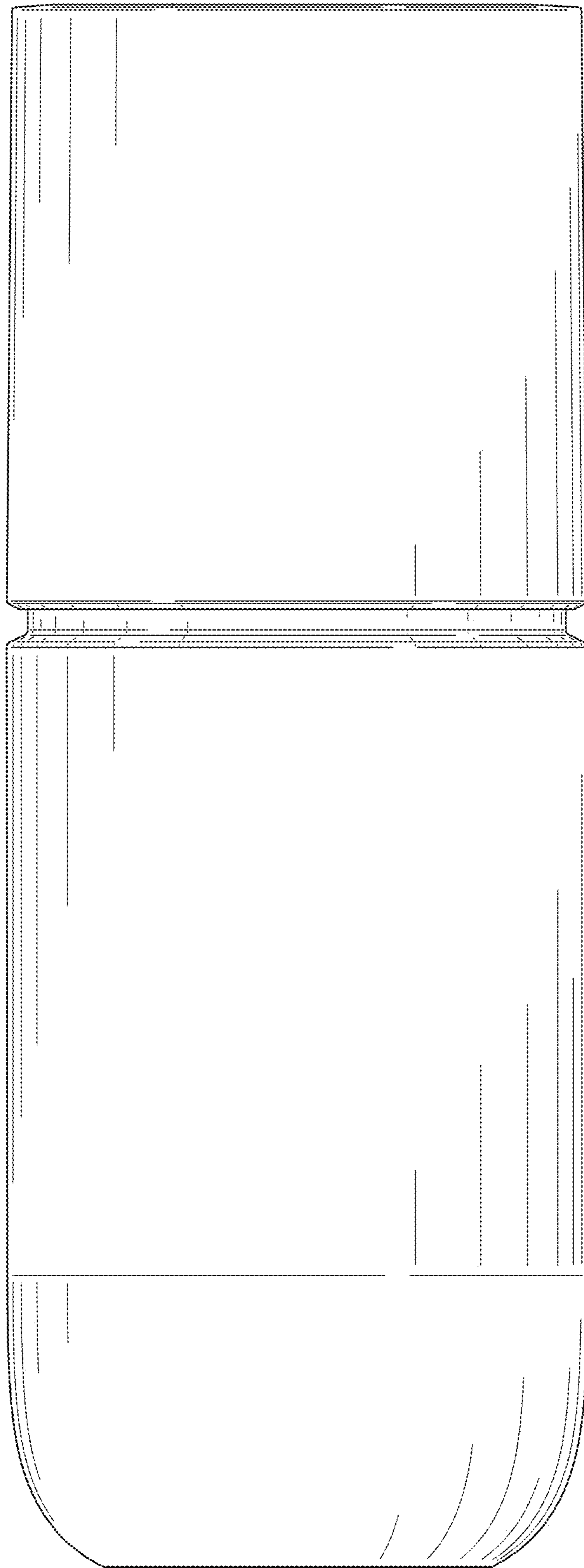

FIG. 28

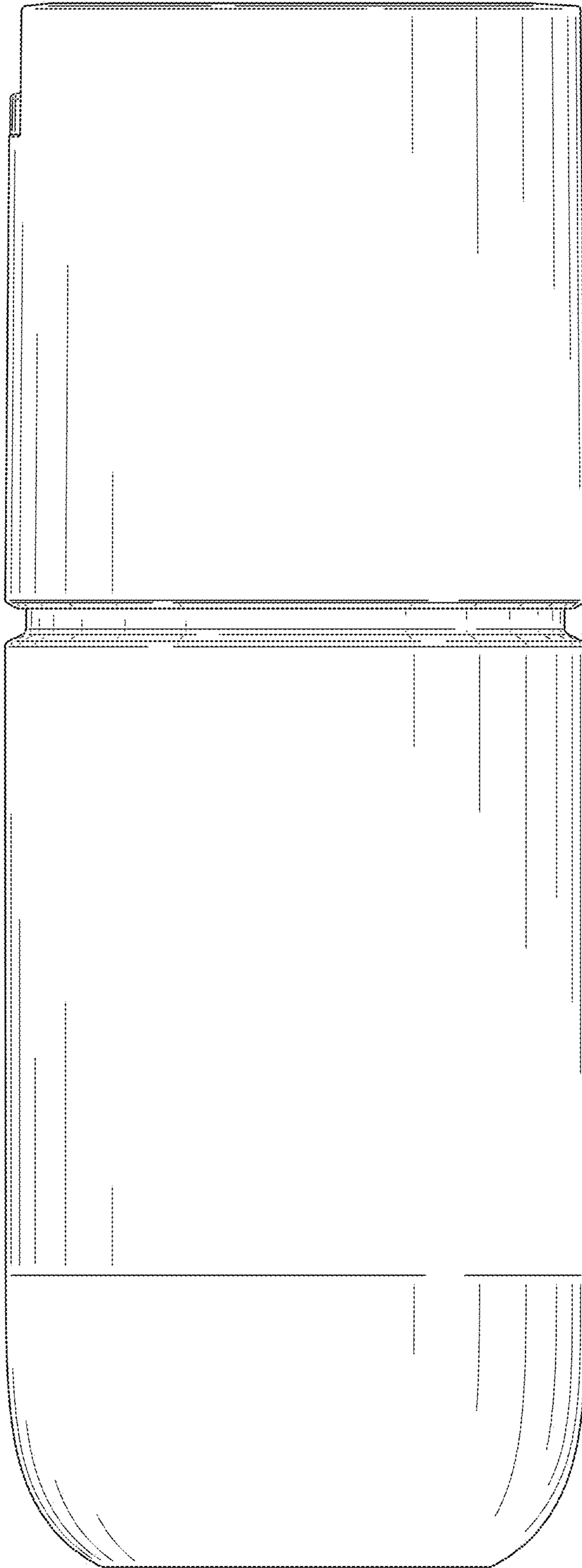

FIG. 29

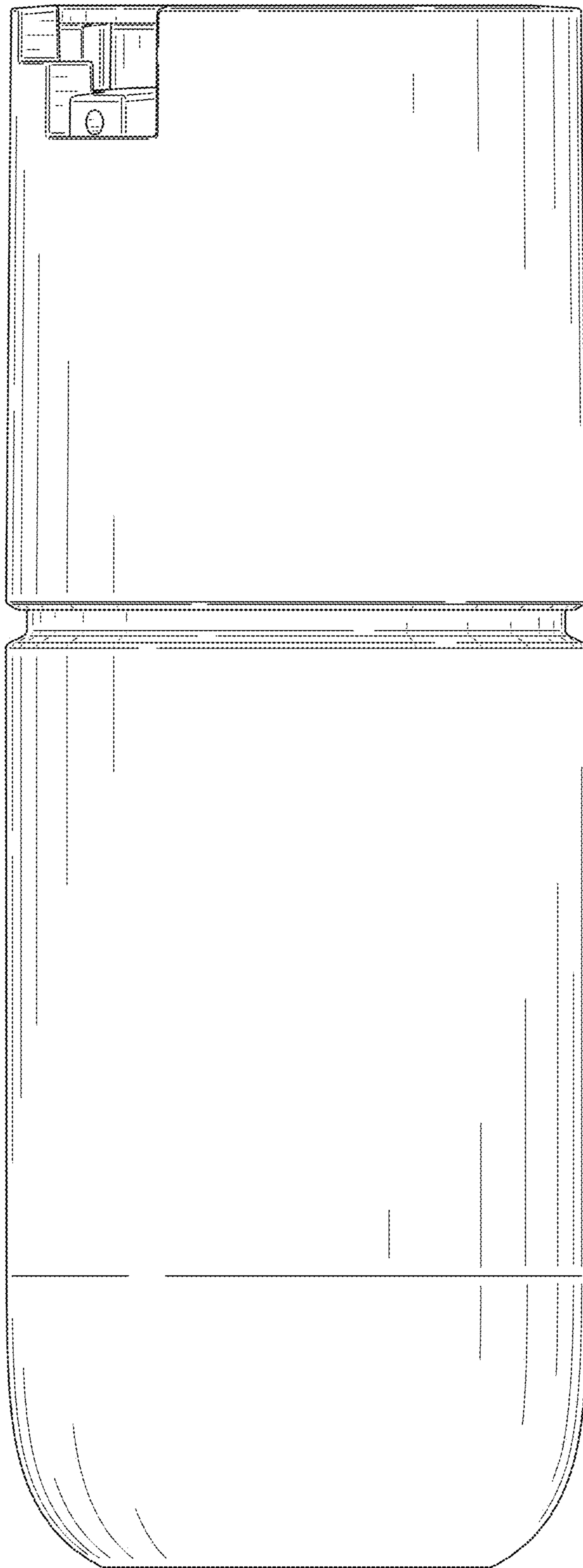

FIG. 30

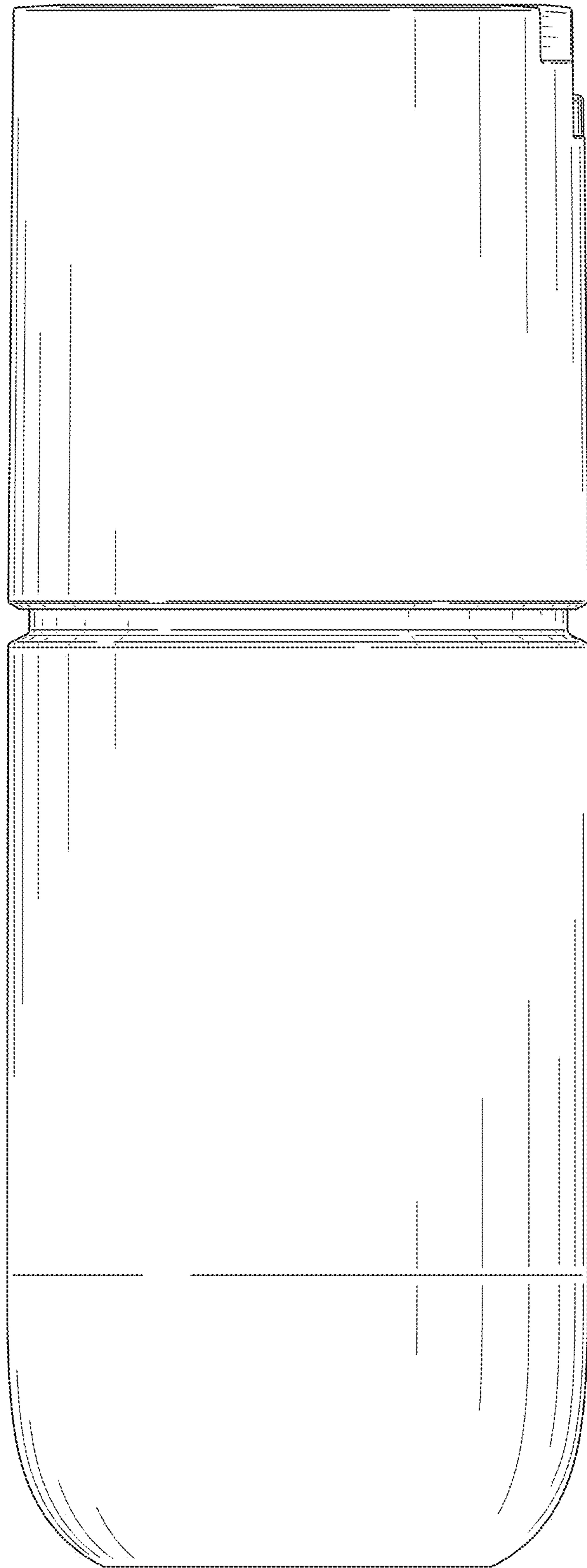

FIG. 31

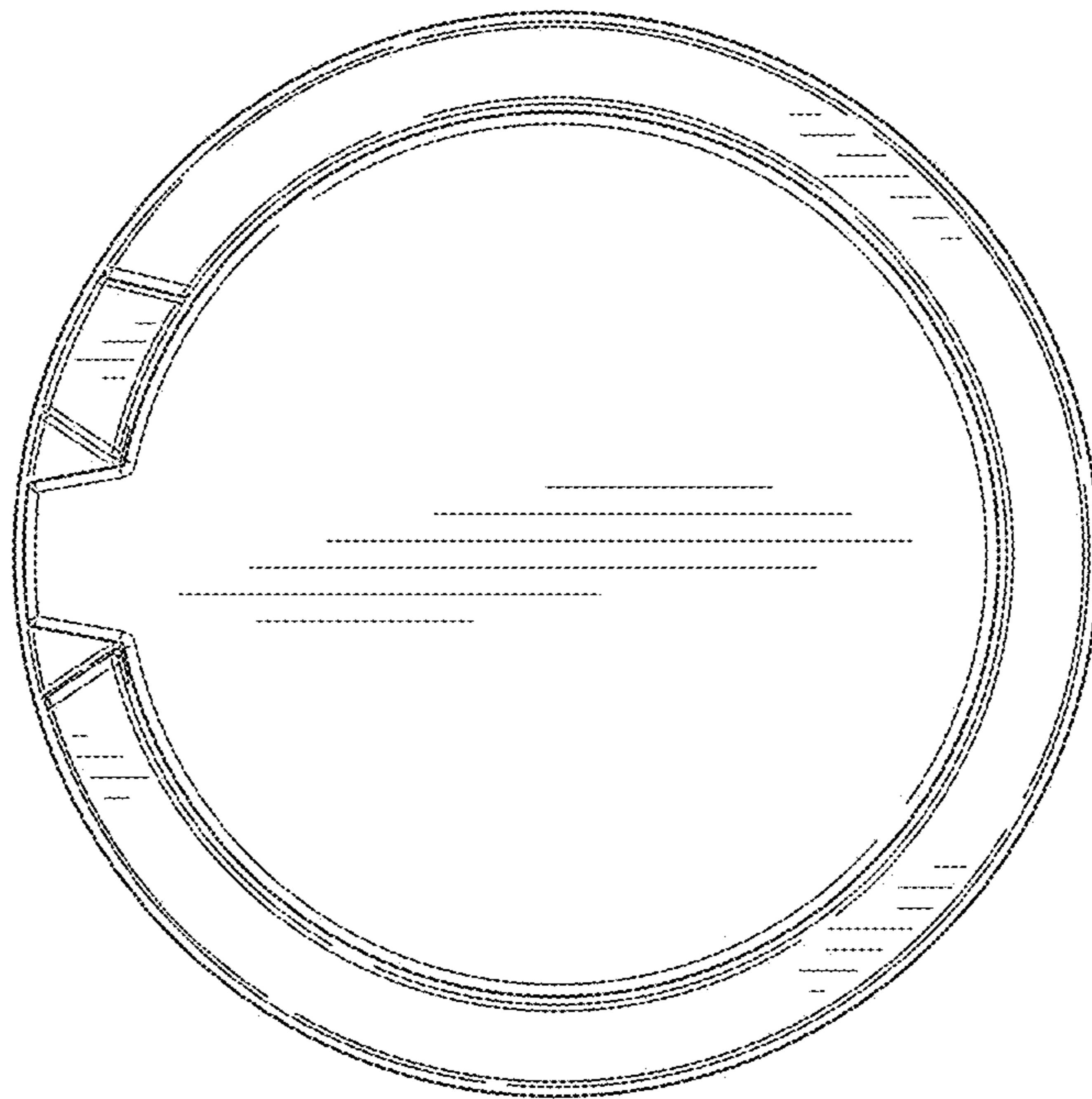

FIG. 32

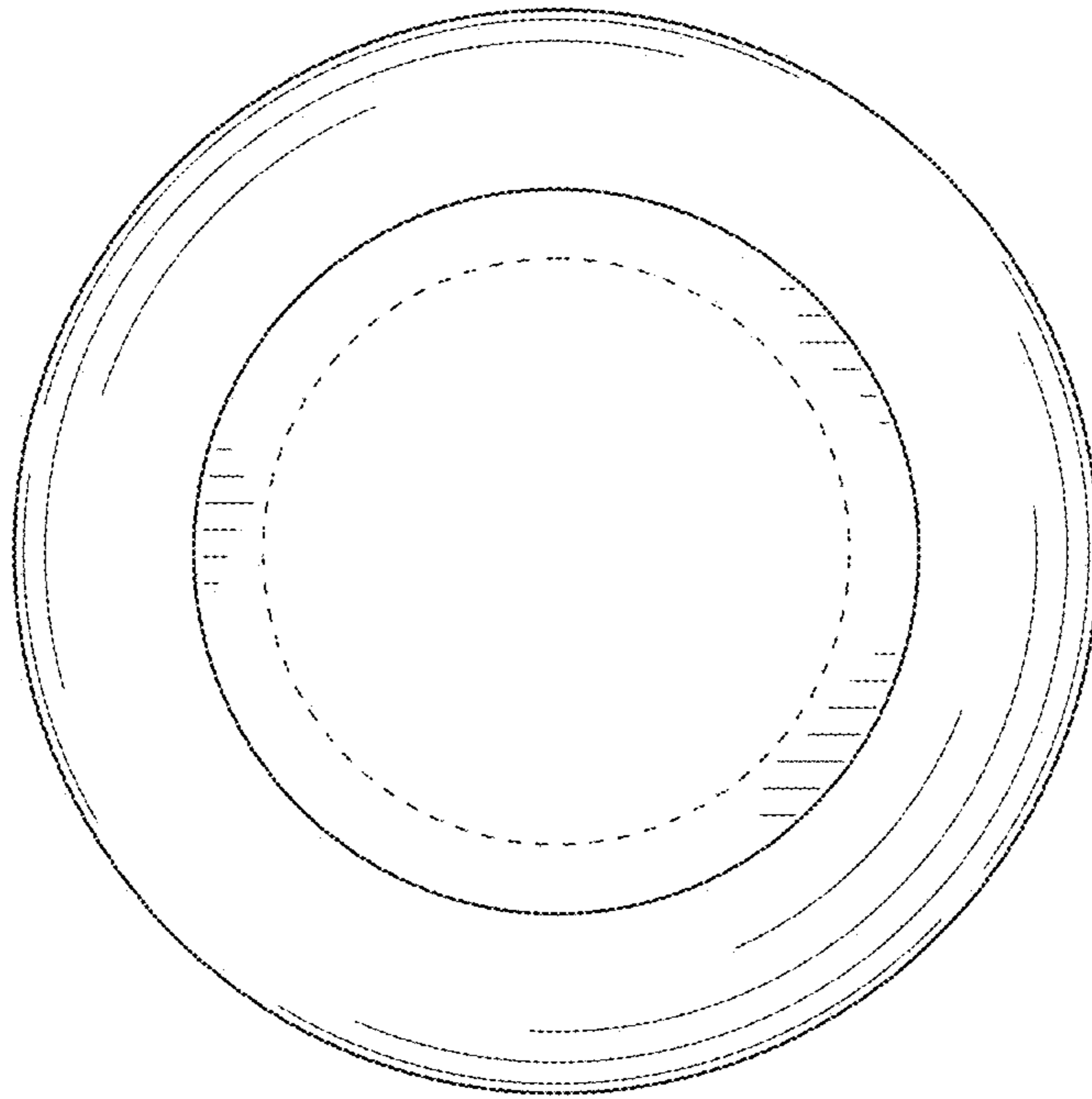

FIG. 33