



US00D920802S

(12) **United States Design Patent**  
**Davis**

(10) **Patent No.:** **US D920,802 S**  
(45) **Date of Patent:** **\*\* \*Jun. 1, 2021**

(54) **DISPENSER**

FOREIGN PATENT DOCUMENTS

(71) Applicant: **S.C. JOHNSON & SON, INC.**,  
Racine, WI (US)

CA 134046 A 9/2010  
CN 302980101 10/2014

(Continued)

(72) Inventor: **Brian T. Davis**, Burlington, WI (US)

OTHER PUBLICATIONS

(73) Assignee: **S. C. Johnson & Son, Inc.**, Racine, WI  
(US)

Airless Bottles <<http://www.airlessbottles.com/airlessbottles.html>>  
2014 (5 pages).

(\*) Notice: This patent is subject to a terminal disclaimer.

(Continued)

(\*\*) Term: **15 Years**

*Primary Examiner* — Catherine A Tuttle

(74) *Attorney, Agent, or Firm* — Quarles & Brady LLP

(21) Appl. No.: **29/722,096**

(57) **CLAIM**

(22) Filed: **Jan. 27, 2020**

The ornamental design for a dispenser, as shown and described.

**Related U.S. Application Data**

**DESCRIPTION**

(63) Continuation-in-part of application No. 29/710,489,  
filed on Oct. 23, 2019.

(51) **LOC (13) Cl.** ..... **09-01**

(52) **U.S. Cl.**

USPC ..... **D9/571; D9/575**

(58) **Field of Classification Search**

USPC ..... D9/682–694, 516, 517, 520–523, 529,  
D9/549–558, 563, 565, 567, 571–575,  
D9/434–436, 445, 448

CPC .. B65D 1/0223; B65D 1/0246; B65D 1/0261;  
B65D 1/09; B65D 1/40; B65D  
2501/0081; B65D 41/62; B05B 11/0027;  
B05B 11/0037

See application file for complete search history.

FIG. 1 is an isometric view of the top, front, and right side of the dispenser embodying my new design; FIG. 2 is a front elevational view thereof; FIG. 3 is a rear elevational view thereof; FIG. 4 is a left side elevational view thereof; FIG. 5 is a right side elevational view thereof; FIG. 6 is a top plan view thereof; FIG. 7 is an isometric view of the top, front, and right side of an alternate embodiment of my design for a dispenser; FIG. 8 is a front elevational view thereof; FIG. 9 is a rear elevational view thereof; FIG. 10 is a left side elevational view thereof; FIG. 11 is a right side elevational view thereof; and, FIG. 12 is a top plan view thereof.

The dash-dash-dash lines are included for the purpose of illustrating portions of the dispenser that form no part of the claimed design. The dash-dot-dash lines are included for the purpose of illustrating boundary lines that form no part of the claimed design.

(56) **References Cited**

**U.S. PATENT DOCUMENTS**

D158,800 S 7/1948 Robb  
D195,772 S 7/1963 Sanders et al.  
(Continued)

**1 Claim, 10 Drawing Sheets**

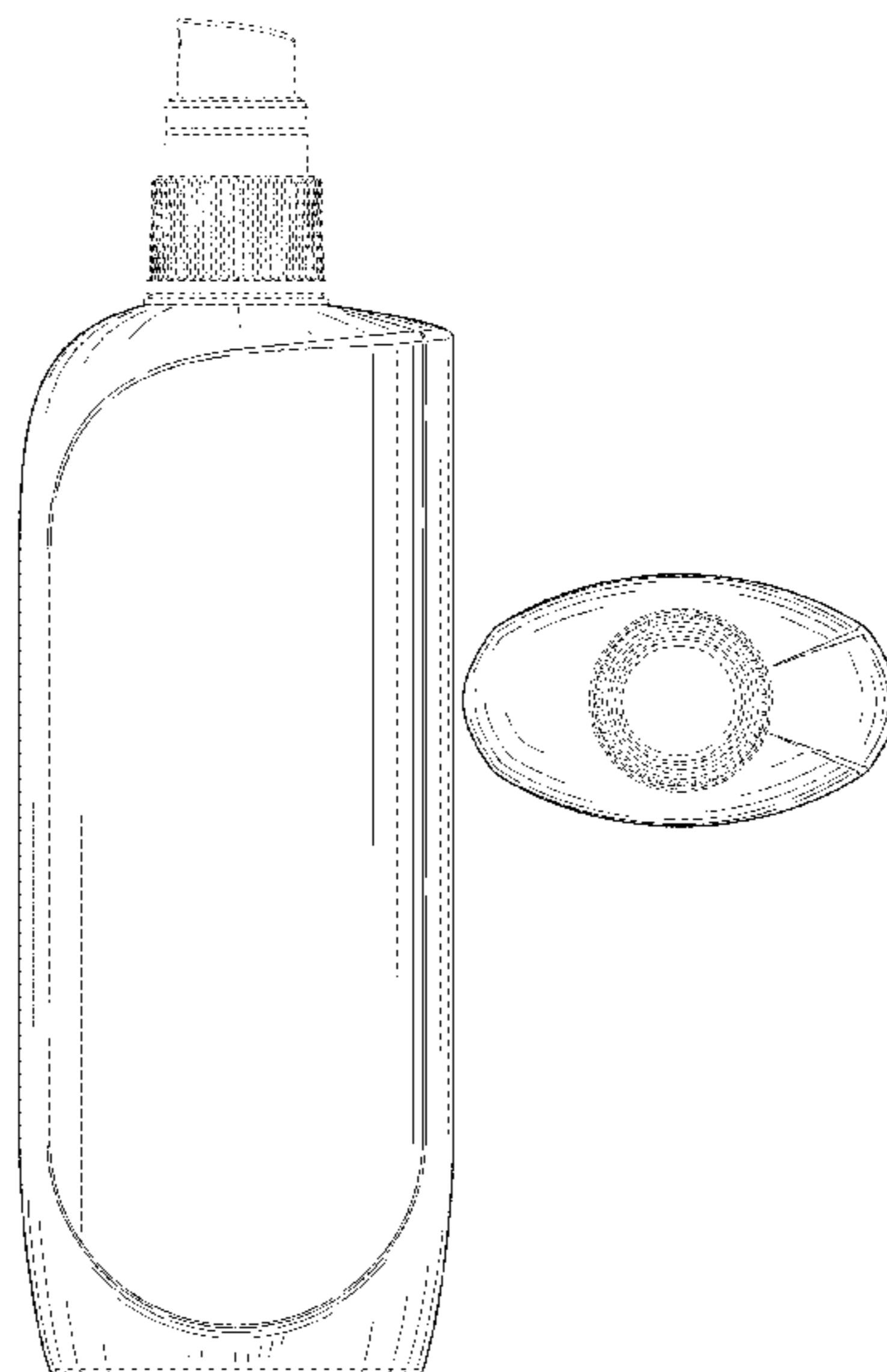

(56)

References Cited

U.S. PATENT DOCUMENTS

D198,593 S *	7/1964	Johns	D9/574	D399,130 S	10/1998	Monaghan	
D213,305 S *	2/1969	O'Brien et al.	D9/524	5,954,213 A *	9/1999	Gerhart	B65D 81/3288 206/514
D215,269 S *	9/1969	Landor	D9/558	D417,624 S	12/1999	Herrmann et al.	
D225,830 S *	1/1973	Hill	D9/694	D418,064 S	12/1999	Pritchard et al.	
D233,653 S *	11/1974	Pardo	D9/686	D419,455 S *	1/2000	Macauley	D9/523
D245,759 S	9/1977	Pardo		D422,509 S	4/2000	Luzzi et al.	
D246,893 S *	1/1978	Eron	D9/689	D424,378 S	5/2000	Bacon et al.	
D246,953 S	1/1978	Britt		D424,925 S	5/2000	Lamb	
4,087,028 A	5/1978	Lang		D424,944 S	5/2000	Mohary et al.	
D250,248 S	11/1978	Grip		D427,073 S	6/2000	Gaffney et al.	
D251,111 S *	2/1979	Furlong	D9/516	D427,520 S	7/2000	Crawford	
D253,032 S	10/1979	White		D434,311 S *	11/2000	Gavin	D9/693
D256,432 S *	8/1980	Beeman	D9/563	D437,775 S	2/2001	Dalmau	
D263,373 S *	3/1982	Howard	D9/563	D440,875 S	4/2001	Sagel	
D263,804 S	4/1982	Kondo et al.		D446,725 S	8/2001	Lloyd	
D264,051 S	4/1982	Perales		D451,009 S	11/2001	Davis	
D264,937 S	6/1982	Groark		D451,402 S	12/2001	Kokenge et al.	
D269,594 S	7/1983	Gurolnick		D453,113 S	1/2002	Feen et al.	
D272,723 S	2/1984	Baker		D458,149 S	6/2002	Cummings	
D281,861 S	12/1985	Jones et al.		D459,650 S	7/2002	Gagnon	
D283,479 S	4/1986	Swett et al.		D460,694 S	7/2002	Llusca	
D284,548 S	7/1986	Rosen		D461,718 S	8/2002	Brozell	
D304,550 S	11/1989	Demarest		D463,747 S	10/2002	Peon et al.	
D304,996 S	12/1989	Hollenberg et al.		D464,874 S	10/2002	Tune et al.	
D305,300 S	1/1990	Kraft		D465,409 S	11/2002	Marandin	
D308,023 S	5/1990	Dinand		D467,183 S	12/2002	Chew	
D308,483 S	6/1990	Weckman		D467,815 S	12/2002	Cummings	
D309,714 S	8/1990	Biesecker		D468,423 S	1/2003	Renfrew	
D310,723 S	9/1990	Su		D471,820 S	3/2003	Faillant-Dumas	
D310,964 S	10/1990	Weckman		D472,154 S *	3/2003	Peon	D9/543
4,969,581 A	11/1990	Seifert et al.		D474,408 S	5/2003	Rennie et al.	
D312,777 S *	12/1990	Courreges	D9/523	D476,902 S	7/2003	Snyder	
D314,139 S	1/1991	Ambasz		D477,535 S	7/2003	Thorpe	
D314,330 S	2/1991	Ambasz		D478,816 S	8/2003	Joubert	
D315,299 S	3/1991	Gerardiello		D482,285 S	11/2003	Desouza	
D316,224 S *	4/1991	Gray	D9/435	D486,006 S	2/2004	Ricci	
D317,253 S	6/1991	Seager		D486,065 S	2/2004	Hutchinson et al.	
D317,261 S	6/1991	Brown et al.		D486,737 S	2/2004	Oates	
D317,832 S	7/1991	Demarest		D489,006 S	4/2004	Guerrero Vallejo	
D321,131 S *	10/1991	Wiseman	D9/552	D489,257 S	5/2004	Braaten et al.	
D321,321 S *	11/1991	Wilgus	D9/523	D489,267 S	5/2004	Rennie et al.	
D322,216 S	12/1991	Zogg et al.		D489,271 S	5/2004	Soomar	
D323,293 S	1/1992	Gutkowski		D490,314 S	5/2004	Wadsworth et al.	
D323,982 S	2/1992	Geiger		D491,064 S	6/2004	Miller et al.	
D324,332 S	3/1992	Seifert et al.		D491,815 S	6/2004	Crawford	
D324,333 S	3/1992	Griffin et al.		D497,038 S	10/2004	Tsai	
D324,338 S	3/1992	Geiger		D498,979 S	11/2004	Bhavnani	
D327,010 S	6/1992	Spiegel		D501,141 S	1/2005	Bakic	
D329,592 S *	9/1992	Crawford	D9/529	D501,637 S *	2/2005	Ferguson	D9/563
D329,983 S	10/1992	Griffin et al.		D502,402 S	3/2005	Schmedes	
D333,433 S *	2/1993	Segati	D9/531	D506,930 S	7/2005	Cauwood et al.	
D333,619 S	3/1993	Lemahieu		D508,407 S	8/2005	Busch et al.	
D333,789 S *	3/1993	Reif	D9/453	D510,527 S	10/2005	Tune	
5,192,005 A	3/1993	Zimmerman		D512,637 S	12/2005	De Monclin	
D346,112 S	4/1994	Alcindor		D515,938 S	2/2006	Shurtleff et al.	
D346,740 S	5/1994	Charet et al.		D517,733 S	3/2006	Tsai	
D348,217 S	6/1994	Le Prince		D519,383 S	4/2006	Stolle	
D351,105 S	10/1994	Grip		D520,374 S	5/2006	Herrmann et al.	
D352,242 S	11/1994	Crawford et al.		D526,204 S	8/2006	Stolle	
D353,332 S	12/1994	Behm et al.		D526,570 S	8/2006	Bakic	
D357,184 S	4/1995	Keith et al.		D526,908 S	8/2006	Blasko et al.	
D357,870 S *	5/1995	O'Neill	D9/516	D527,277 S	8/2006	Blasko et al.	
D361,937 S	9/1995	Maxwell et al.		D528,700 S	9/2006	Oh	
D369,559 S	5/1996	Vilval		D529,812 S	10/2006	Ratzlaff	
D376,103 S	12/1996	Knickerbocker		D530,222 S	10/2006	McConville et al.	
D379,933 S	6/1997	Lambrecht		D531,037 S	10/2006	Mongeon et al.	
D381,895 S	8/1997	Cheng		D531,038 S	10/2006	Mongeon et al.	
D382,803 S	8/1997	Gavin		D531,904 S	11/2006	Sillett et al.	
D382,813 S	8/1997	Lambrecht		D531,906 S	11/2006	Mongeon et al.	
D387,992 S	12/1997	Kotoucek		D532,309 S	11/2006	Stolle	
D388,330 S *	12/1997	Zimmer	D9/543	D532,698 S	11/2006	Pridmore et al.	
D392,896 S	3/1998	Weber		D533,066 S	12/2006	Mongeon et al.	
D392,898 S	3/1998	Butler et al.		D533,074 S	12/2006	Mongeon et al.	
D397,038 S *	8/1998	Estrin	D9/523	D533,784 S	12/2006	Bakic	
D398,534 S	9/1998	Verdura, Jr. et al.		D535,567 S *	1/2007	Snyder	D9/551
				D537,355 S	2/2007	Brauner et al.	
				D541,163 S	4/2007	Altonen et al.	
				D541,657 S	5/2007	Mongeon et al.	

(56)

References Cited

U.S. PATENT DOCUMENTS

D541,671 S	5/2007	Stick et al.	D660,160 S	5/2012	Bouma et al.
D542,660 S	5/2007	Thomas et al.	D660,707 S	5/2012	Bouma et al.
D543,113 S	5/2007	Mongeon et al.	D660,708 S	5/2012	Bridgman et al.
D543,114 S	5/2007	Mongeon et al.	D665,261 S	8/2012	Mazurkiewicz et al.
D543,119 S	5/2007	McConville et al.	D669,790 S	10/2012	Powers et al.
D543,461 S	5/2007	Mongeon et al.	D673,812 S	1/2013	Hauser
D543,864 S	6/2007	Cho et al.	D674,282 S	1/2013	Baldrige et al.
D543,865 S	6/2007	Walters et al.	D677,165 S	3/2013	Kersten
D555,877 S	11/2007	Reinoso	D678,069 S	3/2013	Redmond
D558,049 S	12/2007	Eaton et al.	D679,603 S	4/2013	Winn
D558,579 S	1/2008	Blasko et al.	D683,226 S	5/2013	Baldrige et al.
D558,585 S	1/2008	Sheppard et al.	D685,233 S	7/2013	Wong
D563,225 S	3/2008	Mongeon et al.	D686,510 S	7/2013	Zerba et al.
D563,232 S	3/2008	Mongeon et al.	D686,511 S	7/2013	Jung
D565,424 S *	4/2008	Moriya ..... D9/682	D688,134 S	8/2013	ODowd
D566,558 S	4/2008	Bakic	D695,620 S	12/2013	Karekar
D577,590 S	9/2008	Ulicny	D696,140 S	12/2013	Servaire
D578,892 S	10/2008	Bridgman et al.	D704,562 S	5/2014	Nukuto et al.
D581,276 S	11/2008	Kuzma et al.	D705,608 S	5/2014	Wolhender
D582,292 S	12/2008	Short et al.	D706,637 S	6/2014	James
D584,148 S	1/2009	Stolle	D708,481 S	7/2014	Lin
D584,159 S	1/2009	Domoy et al.	D713,728 S	9/2014	Brewer et al.
D584,949 S	1/2009	Mongeon et al.	D714,153 S	9/2014	Brewer et al.
D584,960 S	1/2009	Sherwood	D714,647 S	10/2014	Kersten
D586,220 S	2/2009	Bridgman et al.	D714,648 S	10/2014	Kersten
D587,121 S	2/2009	Mongeon et al.	D715,149 S	10/2014	Brewer et al.
D587,973 S	3/2009	Romano	D716,662 S	11/2014	Brewer et al.
D588,920 S	3/2009	ODonahue	D716,663 S	11/2014	Brewer et al.
D588,923 S	3/2009	Mongeon et al.	D717,175 S	11/2014	Brewer et al.
D589,057 S	3/2009	Azuma	D717,178 S	11/2014	Brewer et al.
D590,259 S	4/2009	Kunesh et al.	D718,144 S	11/2014	Brewer et al.
D598,295 S	8/2009	Miceli et al.	D720,623 S	1/2015	Bunce et al.
D598,769 S	8/2009	Toh et al.	D722,272 S	2/2015	Brewer et al.
D601,027 S	9/2009	Courtaigne Delalande	D724,956 S	3/2015	Johansson
D602,364 S	10/2009	Mongeon et al.	D726,541 S	4/2015	Xu et al.
D602,365 S	10/2009	Willows et al.	D726,542 S	4/2015	Xu et al.
D603,708 S	11/2009	Handy	D728,368 S	5/2015	Alschbach
D605,521 S	12/2009	Mongeon et al.	D728,369 S	5/2015	Bos et al.
D606,411 S	12/2009	Mongeon et al.	D729,627 S	5/2015	Sumida et al.
D606,867 S	12/2009	Fugate et al.	D730,189 S	5/2015	Haile
D607,726 S	1/2010	Wisniewski	D730,737 S	6/2015	Bunce et al.
D608,640 S	1/2010	Carreno	D731,894 S	6/2015	Meyer
D608,647 S	1/2010	Toh et al.	D732,398 S	6/2015	Landrum et al.
D610,021 S	2/2010	Kinoshita et al.	D734,158 S	7/2015	Sumida et al.
D610,402 S	2/2010	Carreno	D734,661 S	7/2015	Sumida et al.
D611,348 S	3/2010	Handy	D735,042 S	7/2015	Simon et al.
D614,494 S *	4/2010	Palmer ..... D9/516	D736,090 S	8/2015	Kikuchi
D617,198 S	6/2010	Lee et al.	D737,685 S	9/2015	Landrum et al.
D617,202 S	6/2010	Kuzma et al.	D737,686 S	9/2015	Landrum et al.
D618,102 S	6/2010	Toh et al.	D738,219 S	9/2015	Landrum et al.
D618,114 S	6/2010	Lee et al.	D740,665 S	10/2015	Becker et al.
D619,893 S	7/2010	Fiore et al.	D740,666 S	10/2015	Corradini et al.
D622,606 S	8/2010	Masotti et al.	D740,677 S	10/2015	Kuzma et al.
D623,540 S	9/2010	Vepuri	D740,680 S	10/2015	Christian
D624,424 S	9/2010	Fiore et al.	D741,190 S	10/2015	Rodriguez et al.
D624,641 S	9/2010	Boclet	D742,228 S	11/2015	Dyer et al.
D626,843 S	11/2010	Oates et al.	D748,483 S	2/2016	Snyder
D626,858 S *	11/2010	Oates ..... D9/682	D748,497 S	2/2016	Cruz
D627,232 S	11/2010	Toh et al.	D750,487 S	3/2016	Marina et al.
D629,302 S	12/2010	Toh et al.	D752,987 S	4/2016	Dyer et al.
D632,585 S	2/2011	Jebb et al.	D756,215 S	5/2016	Noguchi et al.
D632,970 S	2/2011	Drake et al.	D756,235 S	5/2016	Dyer et al.
D633,390 S	3/2011	Toh et al.	D758,737 S	6/2016	Tan et al.
D644,106 S	8/2011	Almstead, Jr. et al.	D758,877 S	6/2016	Vaughn-Batiz
D644,107 S	8/2011	Hirst et al.	D764,309 S	8/2016	Yakos et al.
D644,109 S	8/2011	Hirst et al.	D773,305 S	12/2016	Toh et al.
D647,248 S	10/2011	Somers et al.	D773,306 S	12/2016	Toh et al.
D649,465 S	11/2011	Oates et al.	D778,097 S	2/2017	Muspratt-Williams et al.
D652,715 S	1/2012	Quinter et al.	D778,727 S	2/2017	Landrum et al.
D653,554 S	2/2012	Kitazawa et al.	D786,681 S	5/2017	Toh et al.
D658,070 S	4/2012	Lanz	D788,594 S	6/2017	Elkouby
D659,002 S	5/2012	Jebb et al.	D790,969 S	7/2017	Eastcott et al.
D660,157 S	5/2012	Bouma et al.	D790,976 S	7/2017	Eastcott et al.
D660,158 S	5/2012	Bouma et al.	D790,977 S	7/2017	Landrum et al.
D660,159 S	5/2012	Bouma et al.	D792,232 S	7/2017	Miller et al.
			D796,961 S	9/2017	Klein et al.
			D801,820 S	11/2017	Mefford

# US D920,802 S

(56)

## References Cited

### U.S. PATENT DOCUMENTS

D807,195 S     1/2018 Richmond  
 D823,686 S     7/2018 Beaudouin et al.  
 D844,443 S     4/2019 Miller et al.

### FOREIGN PATENT DOCUMENTS

DM	020671	11/1991
DM	024296	12/1992
DM	034464	12/1995
DM	040449	8/1997
DM	040450	8/1997
DM	041759	12/1997
DM	041760	12/1997
DM	042547	3/1998
DM	043402	5/1998
DM	043537	6/1998
DM	055667	12/2000
DM	063106	4/2003
DM	074610	6/2010
DM	073282	9/2010
DM	077585	2/2012
DM	083616	3/2014
DM	093563	4/2017
EM	000018957-0004	10/2003
EM	000018957-0007	10/2003
EM	000023114-0002	10/2003
EM	000055207-0001	11/2003
EM	000061635-0001	11/2003
EM	000061031-0001	12/2003
EM	000086707-0001	1/2004
EM	000091244-0001	3/2004
EM	000126859-0002	4/2004
EM	000124243-0010	6/2004
EM	000133574-0001	6/2004
EM	000145446-0004	6/2004
EM	000145446-0014	6/2004
EM	000171079-0003	7/2004
EM	000173018-0001	7/2004
EM	000192935-0002	8/2004
EM	000227608-0011	12/2004
EM	000238027-0001	12/2004
EM	000239934-0003	12/2004
EM	000248745-0014	2/2005
EM	000329123-0005	6/2005
EM	000343041-0001	7/2005
EM	000343066-0001	7/2005
EM	000343090-0001	7/2005
EM	000343116-0001	7/2005
EM	000340542-0001	9/2005
EM	000391255-0001	10/2005
EM	000434014-0001	1/2006
EM	000447958-0002	1/2006
EM	000447958-0003	1/2006
EM	000466115-0001	2/2006
EM	000453147-0001	4/2006
EM	000493242-0001	5/2006
EM	000493242-0002	5/2006
EM	000493242-0003	5/2006
EM	000176953-0001	7/2006
EM	000510276-0002	7/2006
EM	000552997-0003	8/2006
EM	000576335-0001	9/2006
EM	000576335-0004	9/2006
EM	000576335-0006	9/2006
EM	000576335-0007	9/2006
EM	000576335-0010	9/2006
EM	000576335-0022	9/2006
EM	000576335-0023	9/2006
EM	000576335-0024	9/2006
EM	000576335-0025	9/2006
EM	000576335-0026	9/2006
EM	000576335-0027	9/2006
EM	000598164-0001	10/2006
EM	000598164-0002	10/2006
EM	000598966-0003	11/2006

EM	000598966-0007	11/2006
EM	000636717-0001	1/2007
EM	000642244-0001	1/2007
EM	000678677-0004	3/2007
EM	000718184-0001	6/2007
EM	000718184-0002	6/2007
EM	000718184-0003	6/2007
EM	000761135-0001	8/2007
EM	000766654-0008	8/2007
EM	000766654-0016	8/2007
EM	000766654-0017	8/2007
EM	000766654-0018	8/2007
EM	000766654-0019	8/2007
EM	000378641-0001	9/2007
EM	000378641-0002	9/2007
EM	000378641-0003	9/2007
EM	000378641-0004	9/2007
EM	000378641-0005	9/2007
EM	000378641-0006	9/2007
EM	000378641-0007	9/2007
EM	000378641-0009	9/2007
EM	000378641-0010	9/2007
EM	000378641-0012	9/2007
EM	000378641-0013	9/2007
EM	000378641-0014	9/2007
EM	000378641-0015	9/2007
EM	000378641-0016	9/2007
EM	000378641-0017	9/2007
EM	000378641-0018	9/2007
EM	000378658-0001	9/2007
EM	000378658-0002	9/2007
EM	000378658-0003	9/2007
EM	000378658-0004	9/2007
EM	000378658-0005	9/2007
EM	000378658-0006	9/2007
EM	000378658-0007	9/2007
EM	000378658-0008	9/2007
EM	000378658-0009	9/2007
EM	000378658-0010	9/2007
EM	000378658-0011	9/2007
EM	000378658-0012	9/2007
EM	000378658-0013	9/2007
EM	000378658-0014	9/2007
EM	000378658-0015	9/2007
EM	000378658-0016	9/2007
EM	000780416-0004	9/2007
EM	000780416-0006	9/2007
EM	000780416-0009	9/2007
EM	000780416-0015	9/2007
EM	000777818-0001	11/2007
EM	000807656-0001	11/2007
EM	000862388-0001	2/2008
EM	000858360-0001	3/2008
EM	000864863-0039	4/2008
EM	000911136-0001	5/2008
EM	000522073-0001	6/2008
EM	000522073-0002	6/2008
EM	000522073-0003	6/2008
EM	000522073-0004	6/2008
EM	000522073-0005	6/2008
EM	000522073-0006	6/2008
EM	000522073-0007	6/2008
EM	000522073-0008	6/2008
EM	000522073-0009	6/2008
EM	000522073-0010	6/2008
EM	000522073-0011	6/2008
EM	000522073-0012	6/2008
EM	000522073-0013	6/2008
EM	000522073-0014	6/2008
EM	000522073-0015	6/2008
EM	000522073-0016	6/2008
EM	000522073-0017	6/2008
EM	000522073-0018	6/2008
EM	000522073-0019	6/2008
EM	000522073-0020	6/2008
EM	000522073-0021	6/2008
EM	000522073-0022	6/2008
EM	000522073-0023	6/2008
EM	000522073-0024	6/2008

(56)

## References Cited

FOREIGN PATENT DOCUMENTS			EM		
EM	000522073-0025	6/2008	EM	002696310-0021	5/2015
EM	000522073-0026	6/2008	EM	002696310-0029	5/2015
EM	000522073-0027	6/2008	EM	002697953-0001	5/2015
EM	000522073-0032	6/2008	EM	002713370-0002	6/2015
EM	000522073-0033	6/2008	EM	002714121-0001	8/2015
EM	000948005-0001	6/2008	EM	002744607-0003	10/2015
EM	001046353-0001	1/2009	EM	002744607-0004	10/2015
EM	001055107-0001	3/2009	EM	002914911-0004	1/2016
EM	001077929-0003	3/2009	EM	003105840-0009	5/2016
EM	001084453-0001	3/2009	EM	003235878-0002	8/2016
EM	001544396-0001	7/2009	EM	003378314-0005	9/2016
EM	001599630-0001	10/2009	EM	002738252-0001	10/2016
EM	001599630-0002	10/2009	EM	002738252-0002	10/2016
EM	001599630-0003	10/2009	EM	003422724-0001	10/2016
EM	001650433-0002	2/2010	EM	003780469-0001	3/2017
EM	001670761-0001	2/2010	EM	003780469-0002	3/2017
EM	001684010-0009	3/2010	EM	003780469-0003	3/2017
EM	001690157-0005	4/2010	EM	003780469-0004	3/2017
EM	001212617-0002	6/2010	EM	003780469-0005	3/2017
EM	001216121-0005	6/2010	EM	003780469-0006	3/2017
EM	001714999-0001	6/2010	EM	003780469-0007	3/2017
EM	001740291-0012	8/2010	EM	003780469-0008	3/2017
EM	001744848-0006	10/2010	EM	003780469-0009	3/2017
EM	001795584-0001	12/2010	EM	003780469-0010	3/2017
EM	001846189-0001	4/2011	EM	003780469-0011	3/2017
EM	001846189-0002	4/2011	EM	003780469-0012	3/2017
EM	001846189-0003	4/2011	EM	003780469-0013	3/2017
EM	001846189-0004	4/2011	EM	003780469-0014	3/2017
EM	001896929-0003	8/2011	EM	003780469-0015	3/2017
EM	001903949-0001	10/2011	EM	003780469-0016	3/2017
EM	001309678-0002	2/2012	EM	003877653-0028	5/2017
EM	001309678-0003	2/2012	EM	004002418-0001	5/2017
EM	001311161-0007	2/2012	EM	004030690-0003	6/2017
EM	001317481-0001	3/2012	EM	004549251-0001	1/2018
EM	001317481-0002	3/2012	EM	004549251-0002	1/2018
EM	001286561-0001	4/2012	EM	003037092-0003	2/2018
EM	001286561-0002	4/2012	EM	005249661-0005	5/2018
EM	001286561-0005	4/2012	EM	005249661-0006	5/2018
EM	001286561-0008	4/2012	GB	4012163	8/2009
EM	001286561-0011	4/2012	JP	1411259	4/2011
EM	001286561-0013	4/2012	WO	D011584-001	10/1988
EM	001286561-0014	4/2012	WO	D015326-001	2/1990
EM	002040071-0002	5/2012	WO	D016160-001	5/1990
EM	001310015-0001	6/2012	WO	D016449-001	6/1990
EM	001351258-0008	2/2013	WO	D020306-001	10/1991
EM	001351258-0013	2/2013	WO	D028814-001	4/1994
EM	002185926-0003	2/2013	WO	D033265-001	8/1995
EM	001364202-0015	3/2013	WO	D040449-008	8/1997
EM	002215426-0001	5/2013	WO	D040450-006	8/1997
EM	002115113-0002	6/2013	WO	D040922-001	9/1997
EM	002255745-0001	6/2013	WO	D040933-008	9/1997
EM	001372833-0001	7/2013	WO	D041759-004	12/1997
EM	002231258-0001	7/2013	WO	D041760-002	12/1997
EM	002282459-0005	11/2013	WO	D041760-003	12/1997
EM	002191742-0001	12/2013	WO	D043040-001	4/1998
EM	002345496-0002	2/2014	WO	D043402-001	5/1998
EM	002405829-0001	2/2014	WO	D043402-003	5/1998
EM	002442434-0019	4/2014	WO	D043537-003	6/1998
EM	002502880-0001	7/2014	WO	D049443-001	12/1999
EM	002478214-0001	8/2014	WO	D052764-001	10/2000
EM	002535211-0001	9/2014	WO	D053361-011	12/2000
EM	002555136-0001	10/2014	WO	D059495-002	5/2002
EM	002555813-0001	10/2014	WO	D061136-002	10/2002
EM	002572354-0003	11/2014	WO	D061647-001	10/2002
EM	001423537-0001	12/2014	WO	D062039-001	12/2002
EM	002581264-0020	1/2015	WO	D064636-001	11/2003
EM	002633602-0003	2/2015	WO	D064851-002	1/2004
EM	002586347-0003	3/2015	WO	D065058-012	3/2004
EM	002664839-0006	3/2015	WO	D065798-002	2/2005
EM	001432124-0006	4/2015	WO	D066664-001	6/2005
EM	002648642-0003	4/2015	WO	D067872-002	11/2006
EM	002641282-0001	5/2015	WO	D069538-001	6/2008
EM	002642579-0002	5/2015	WO	D073259-002	7/2010
EM	002693580-0004	5/2015	WO	D073778-004	9/2010
EM	002696310-0010	5/2015	WO	D076069-005	11/2011
			WO	D078145-002	5/2012
			WO	D077916-008	9/2012
			WO	D080018-002	2/2013
			WO	D079538-003	11/2013

(56)

**References Cited**

FOREIGN PATENT DOCUMENTS

WO	D084134-001	8/2014
WO	D085569-002	2/2015
WO	D085574-001	2/2015
WO	D087151-001	8/2015
WO	D094687-001	2/2017
WO	D092875-001	3/2017
WO	D096643-001	7/2017
WO	D097433-001	9/2017

OTHER PUBLICATIONS

Sell Lotion Bottle, Triangle Shape; Zhejiang Jinsheng Packaging Co., Ltd., China <<https://www.zj-jinsheng.com/>> Registration Date: Apr. 22, 2011 (1 page).

Off! Deep Woods Insect & Mosquito Repellent VII, Insect Repelling Bottle; [online: <https://www.amazon.com/OFF-Deep-Woods-Insect-Repellent/dp/B003AOA3UU>] Accessed Oct. 5, 2018 (10 pages).

Lancaster Sun Bottle, [online: <https://www.amazon.com/Lancaster-Beauty-Velvet-Sublime-Ounce/dp/B0076VXA94>] (earliest available date: Oct. 19, 2015) Retrieved online on: Feb. 1, 2021 (7 pages).

Talcum Powder Bottles, [online URL: <http://www.plastopackindustries.com/talcum-powder-bottles.html#talcum-powder-bottles>] Accessed/ Published Date: Oct. 10, 2017 (1 page).

Wet n Wild Nail Polish Bottle [online [https://www.amazon.com/Black-0-41o-Wet-Wild-0-41fl/dp/B015BV9K44/ref=pd\\_sbs\\_3?pd\\_rd\\_w=jgrpK&pf\\_rd\\_p=c52600a3-624a-4791-b4c4-3b112e19fbbc&pf\\_rd\\_r=XB7QFQZGMSQWH9MVRZ2S&pd\\_rd\\_r=1d6475fd-526d-4941-85c8-9c0fd98c384a&pd\\_rd\\_wg=w5GF2&pd\\_rd\\_i=B015BV9K44&pvc=1](https://www.amazon.com/Black-0-41o-Wet-Wild-0-41fl/dp/B015BV9K44/ref=pd_sbs_3?pd_rd_w=jgrpK&pf_rd_p=c52600a3-624a-4791-b4c4-3b112e19fbbc&pf_rd_r=XB7QFQZGMSQWH9MVRZ2S&pd_rd_r=1d6475fd-526d-4941-85c8-9c0fd98c384a&pd_rd_wg=w5GF2&pd_rd_i=B015BV9K44&pvc=1)] (earliest available date: Sep. 15, 2016) [Retrieved online on: Jan. 26, 2021] (8 pages).

Lotion pump bottle, [online: <https://www.indiamart.com/proddetail/lotion-pump-bottle-4550677748.html>] Accessed/ Published Date: Oct. 11, 2017 (1 page).

HDPE Mars Bottle [online: <https://dir.indiamart.com/impcat/plastic-lotion-bottle.html>] Accessed/ Published Date: Oct. 11, 2017 (1 page).

Shampoo bottle, [online: <https://www.shutterstock.com/image-photo/shampoo-577734331?src=dh90Wy41IDFW0o9-0q6ISA-3-44>] Accessed/ Published Date: Oct. 11, 2017 (1 page).

Acrylic Lotion Bottles, Triangle plastic lotion bottle, Sunrise Packaging [online: <http://www.sunrisepkg.com/products.asp?sclassid=16>] Accessed/ Published Date: Oct. 11, 2017 (1 page).

60ml Gold Triangle Shape Press Pump Lotion Bottle, cosmetic container, press pump bottle, cosmetic bottle cosmetic packaging [online: <https://www.aliexpress.com/item/32218799966.html>] Accessed/ Published date: Oct. 11, 2017 (1 page).

L080 SRS White Color Acrylic 15ml, 30ml and 50ml Plastic Bottle with Lotion Pump, Triangle Lotion Bottle, [online: [https://www.diytrade.com/china/pd/5757221/triangle\\_lotion\\_bottle.html](https://www.diytrade.com/china/pd/5757221/triangle_lotion_bottle.html)] Accessed/ Published Date: Oct. 11, 2017 [Retrieved online on: Jan. 25, 2021] (4 pages).

\* cited by examiner

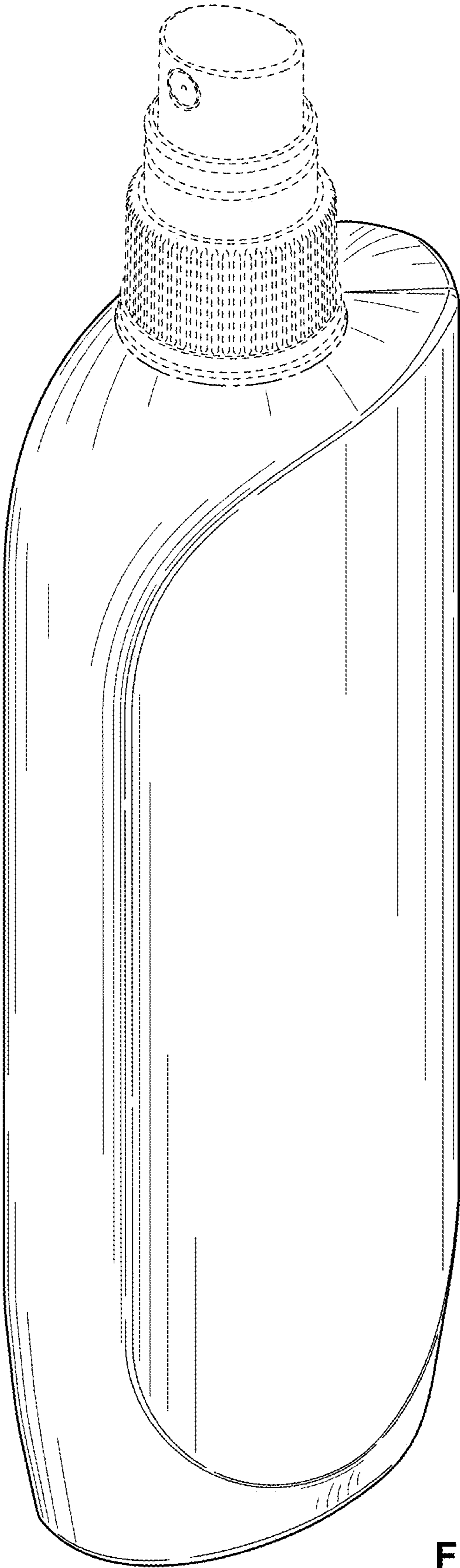

FIG. 1

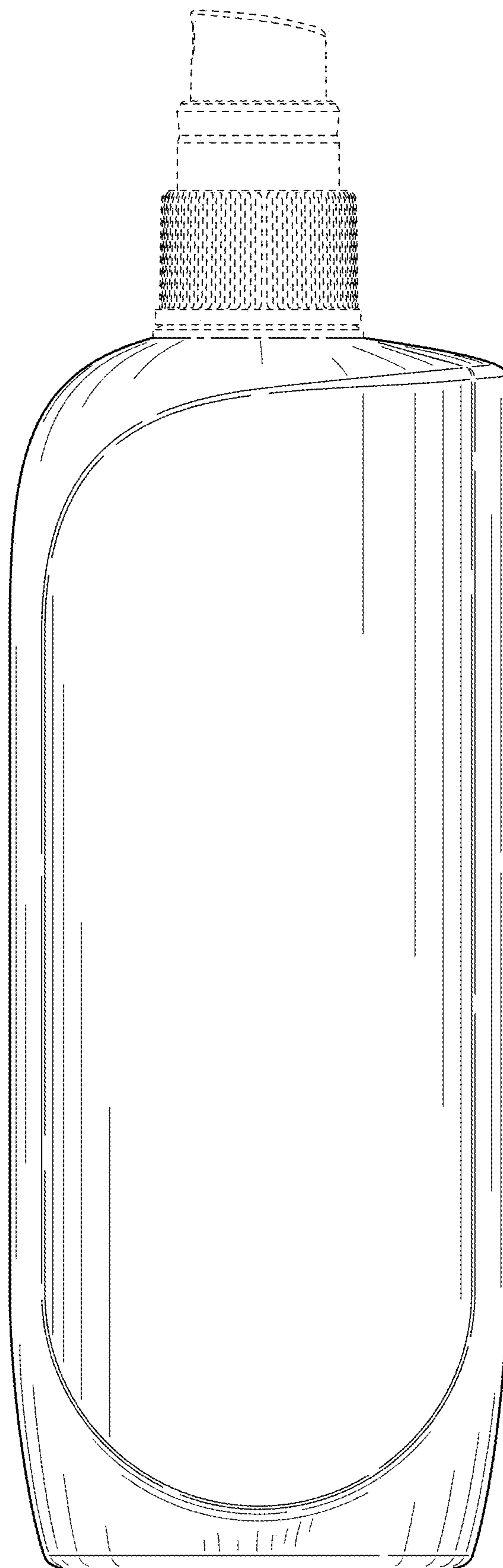

FIG. 2



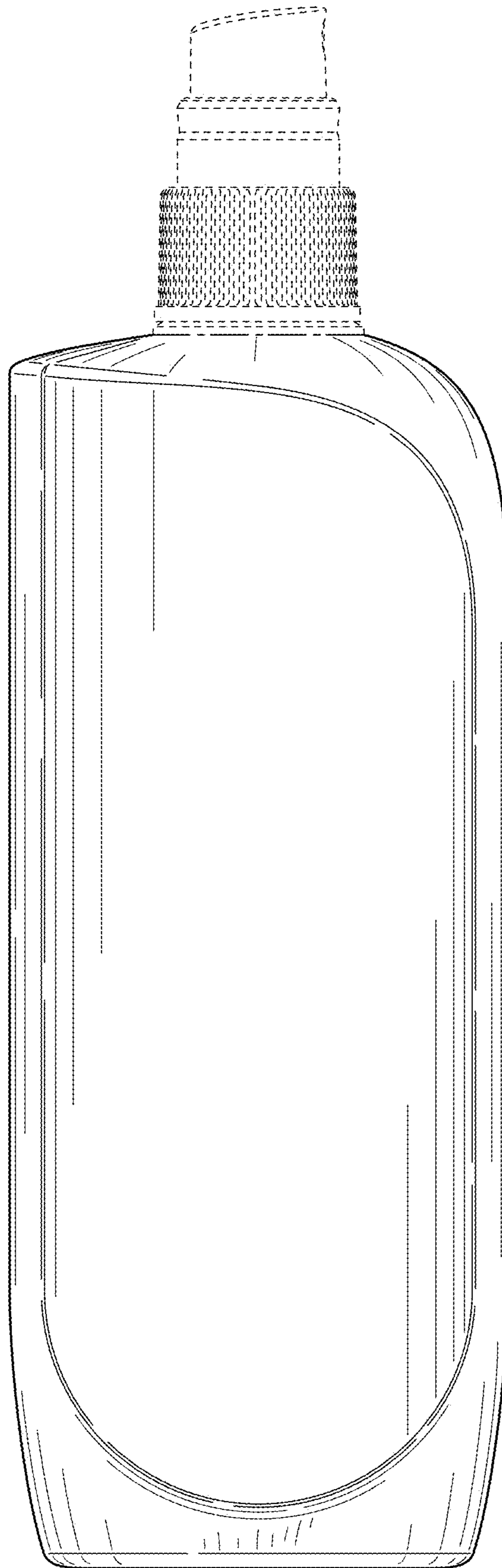

FIG. 3

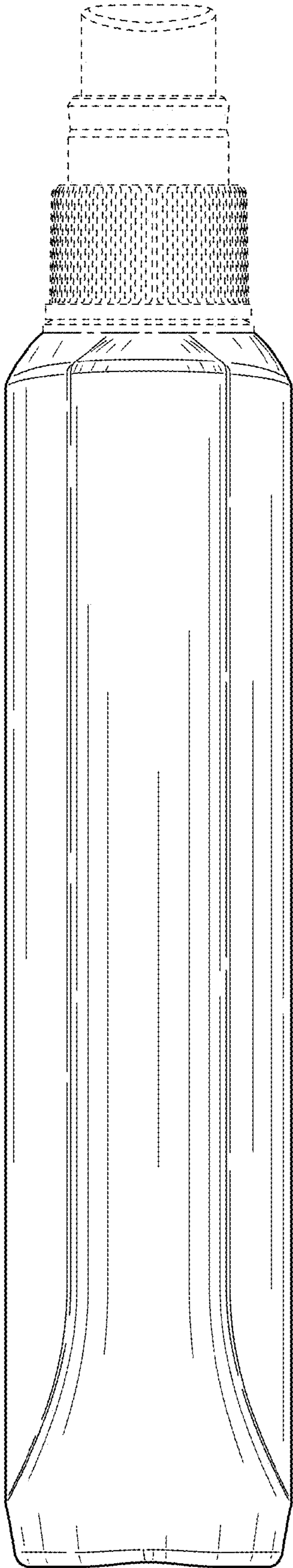

FIG. 4

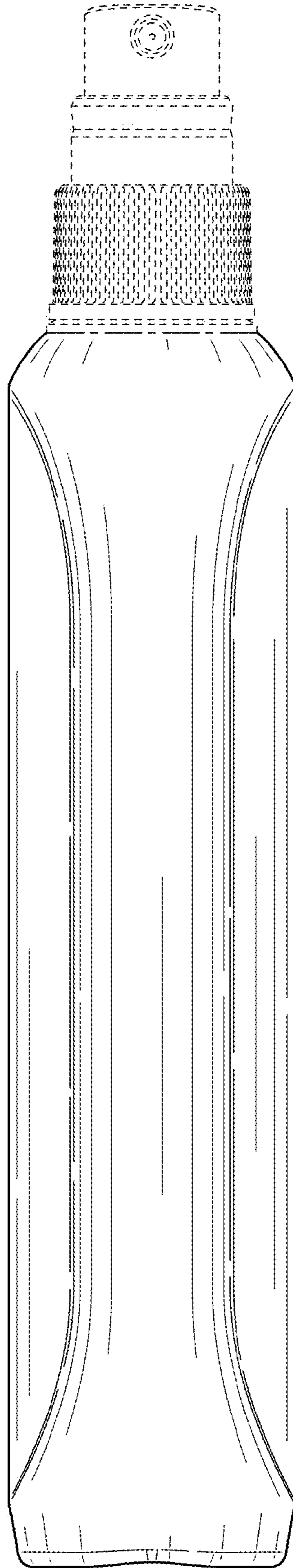
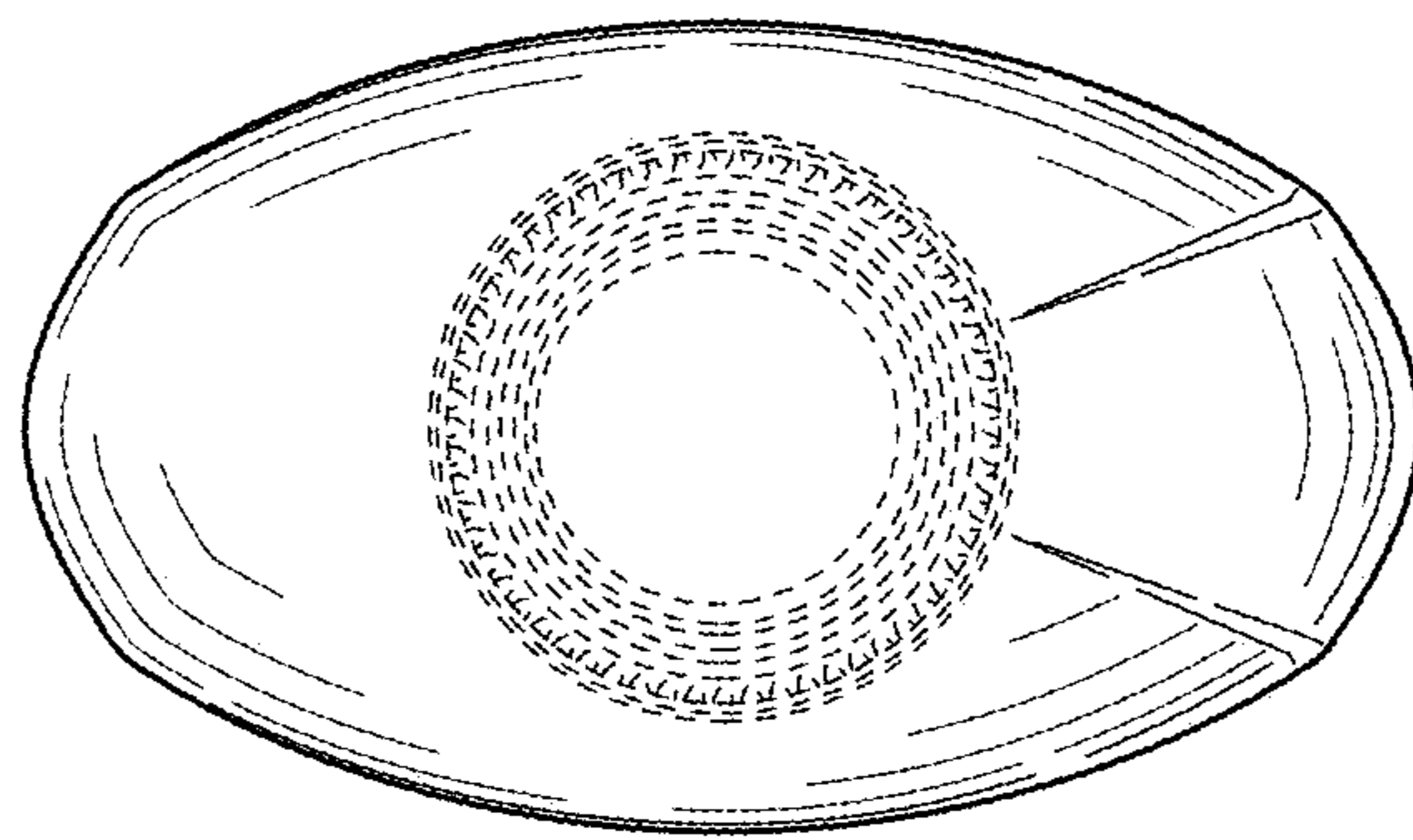

FIG. 5



**FIG. 6**

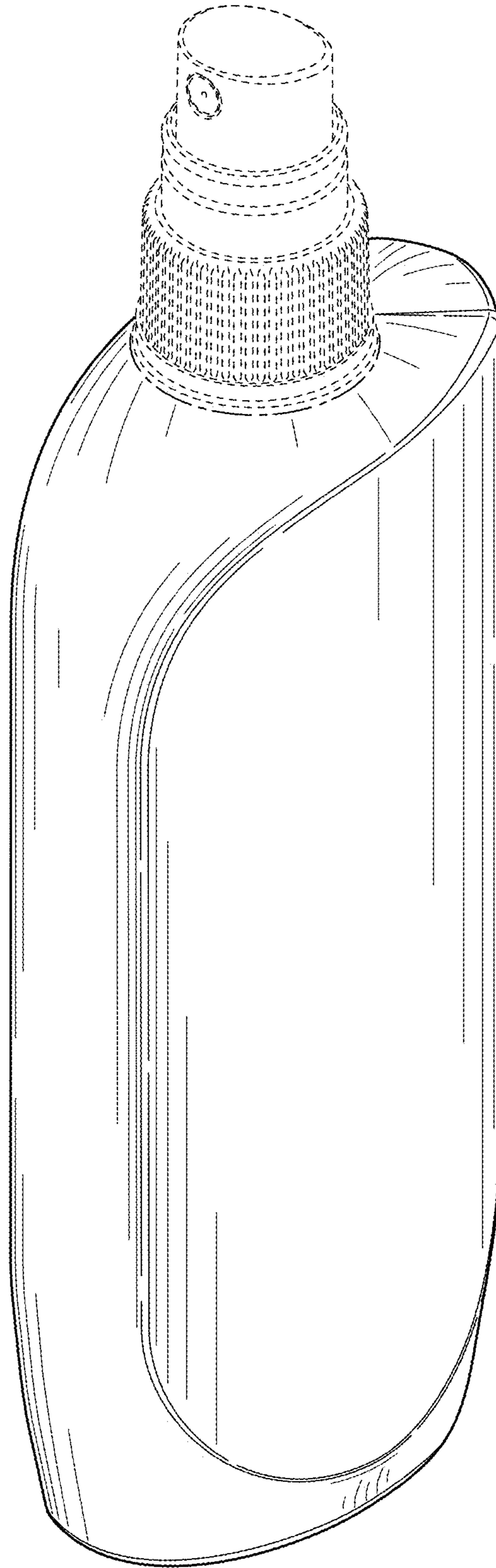

FIG. 7

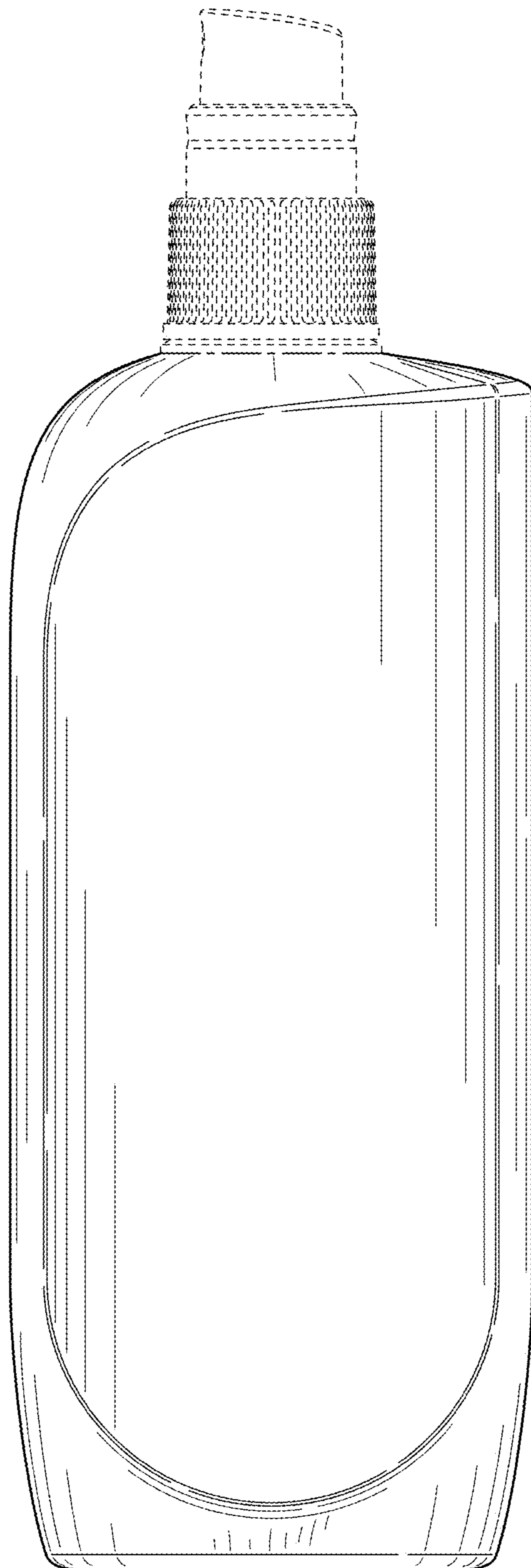

FIG. 8

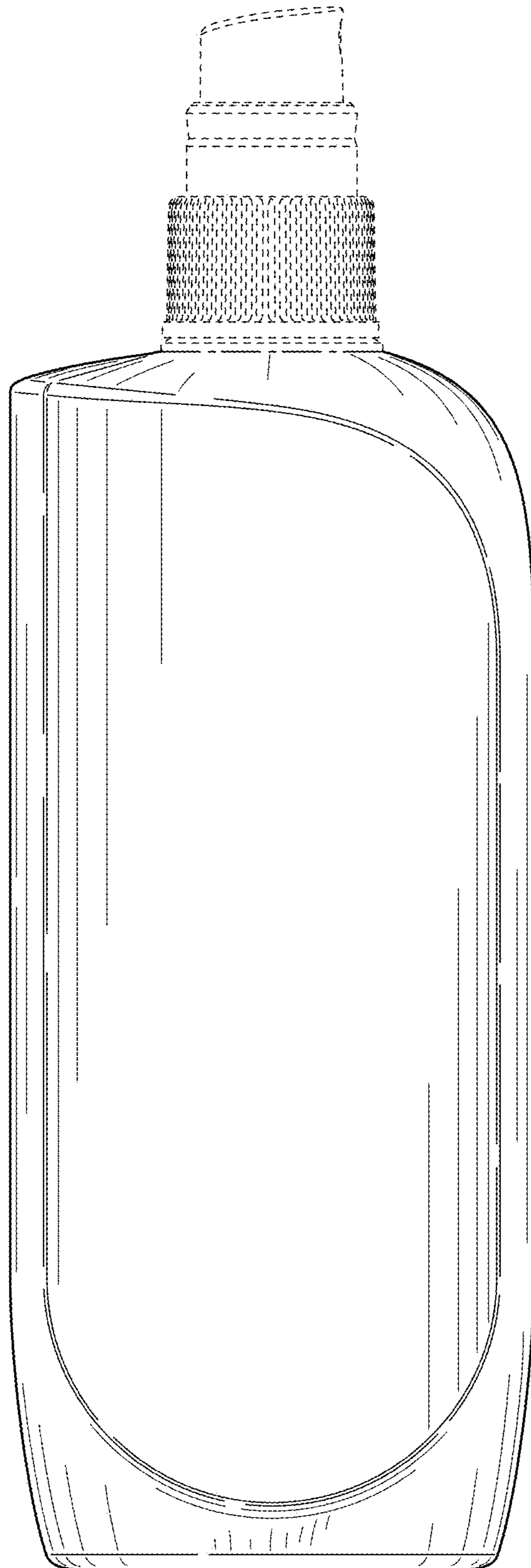

FIG. 9

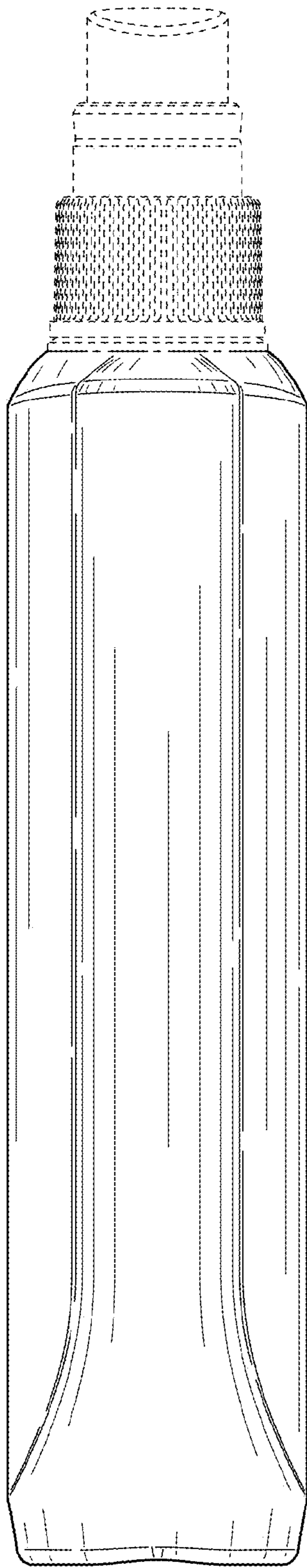

FIG. 10

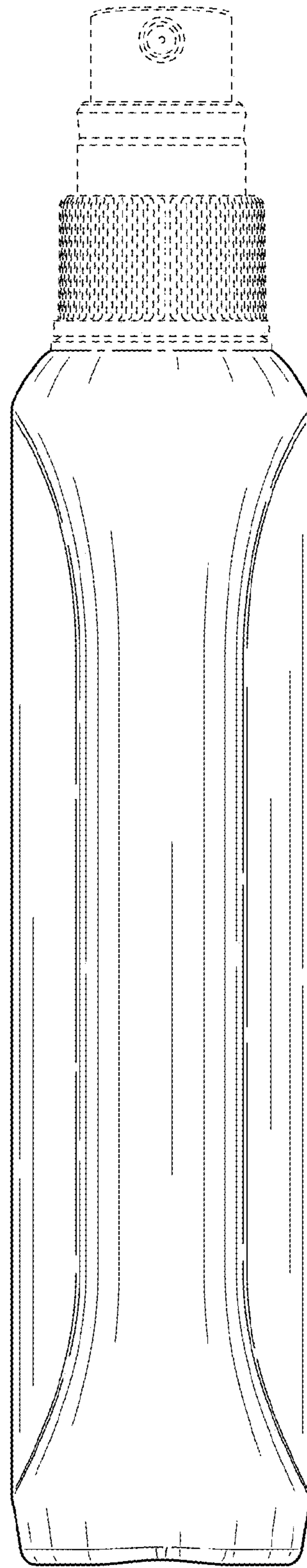

FIG. 11

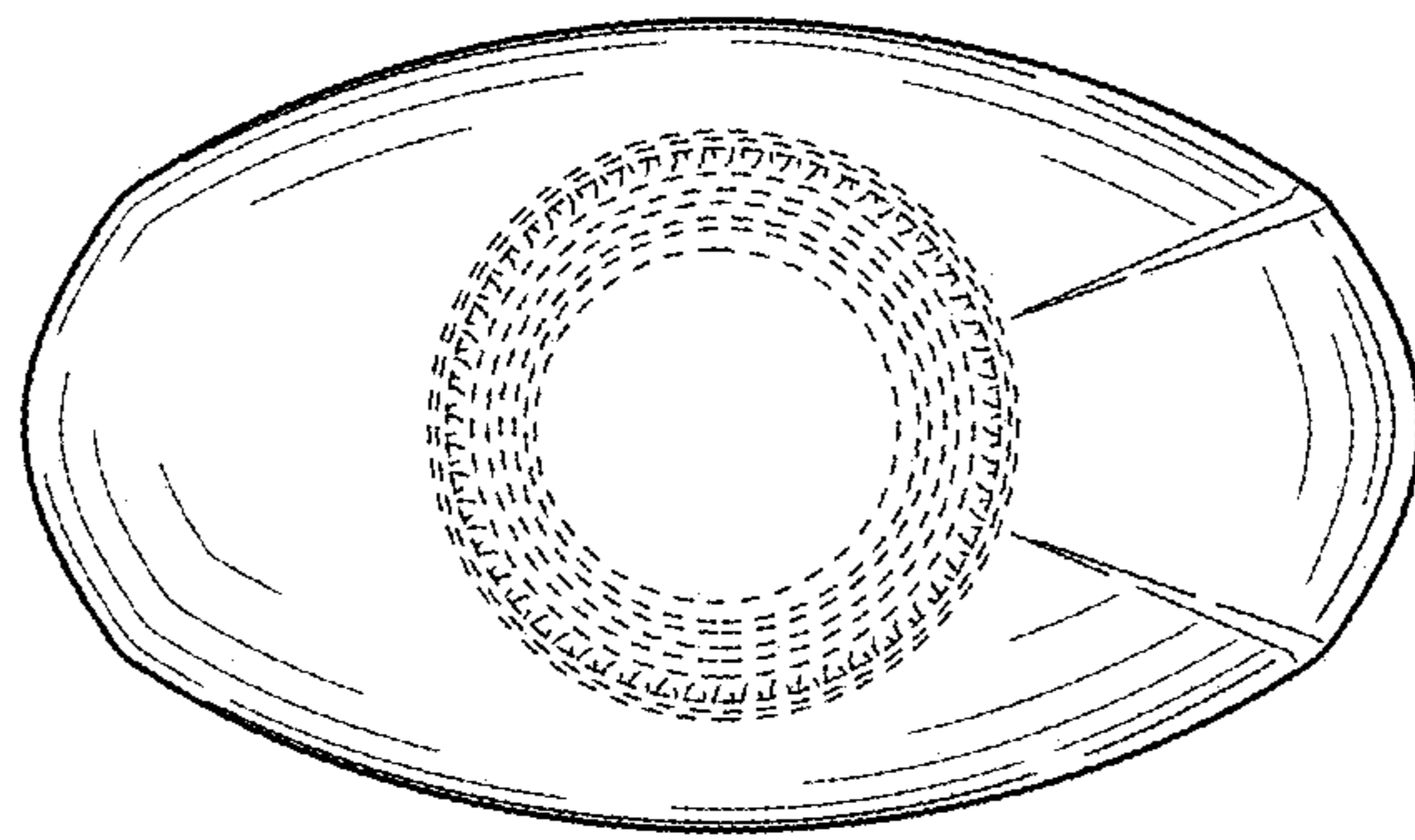

FIG. 12