



US00D920736S

(12) **United States Design Patent**
Bock

(10) **Patent No.:** **US D920,736 S**

(45) **Date of Patent:** **** Jun. 1, 2021**

(54) **BLENDER BASE**

(71) Applicant: **Hamilton Beach Brands, Inc.**, Glen Allen, VA (US)

(72) Inventor: **Brian Bock**, Midlothian, VA (US)

(73) Assignee: **Hamilton Beach Brands, Inc.**, Glen Allen, VA (US)

(**) Term: **15 Years**

(21) Appl. No.: **29/725,884**

(22) Filed: **Feb. 27, 2020**

(51) **LOC (13) Cl.** **31-00**

(52) **U.S. Cl.**

USPC **D7/386; D7/376; D7/378; D7/413**

(58) **Field of Classification Search**

USPC **D7/372, 374, 376–386, 412–413, 602, D7/607, 629, 665–666, 669, 679, D7/693–694**

CPC **A21C 1/02; A21C 1/04; A23N 1/00; A23N 1/02; A47B 77/08; A47J 27/04; A47J 36/321; A47J 43/04; A47J 43/25; A47J 43/27; A47J 43/042; A47J 43/044; A47J 43/046; A47J 43/075; A47J 43/0716; A47J 43/0722; A47J 43/0727; B01F 3/00; B01F 3/0807; B01F 3/0853; B01F 11/0008; B01F 13/0059; B01F 13/0064; B02C 1/08; B02C 2/04; B02C 4/42; B02C 4/142; B02C 4/143; B02C 4/423; B02C 13/1835; B28C 5/10; B28C 5/12; B28C 5/14; B28C 5/16**

See application file for complete search history.

(56) **References Cited**

U.S. PATENT DOCUMENTS

D533,395 S	*	12/2006	Drees	D7/378
D552,412 S	*	10/2007	Steiner	D7/378
D577,537 S	*	9/2008	Lee	D7/378
D605,462 S	*	12/2009	Picozza	D7/378
D644,480 S	*	9/2011	Czach	D7/384
D755,003 S	*	5/2016	Palermo	D7/386
D758,787 S	*	6/2016	Ou	D7/378
D765,465 S	*	9/2016	Du	D7/386
D771,999 S	*	11/2016	Kettavong	D7/386
D788,520 S	*	6/2017	Blaise	D7/378
D809,333 S	*	2/2018	Lee	D7/386

* cited by examiner

Primary Examiner — Ricky Pham

(74) *Attorney, Agent, or Firm* — Alexander D. Raring

(57) **CLAIM**

The ornamental design for a blender base, as shown and described.

DESCRIPTION

FIG. 1 is a perspective view of the claimed design as seen from the top, front and right side of a blender base; FIG. 2 is front view thereof; FIG. 3 is a rear view thereof; FIG. 4 is a left side view thereof; FIG. 5 is a right side view thereof; FIG. 6 is a top view thereof; FIG. 7 is a bottom view thereof; and, FIG. 8 is an additional perspective view thereof. The broken lines in the drawings are included for illustrative purposes only and form no part of the claimed design.

1 Claim, 8 Drawing Sheets

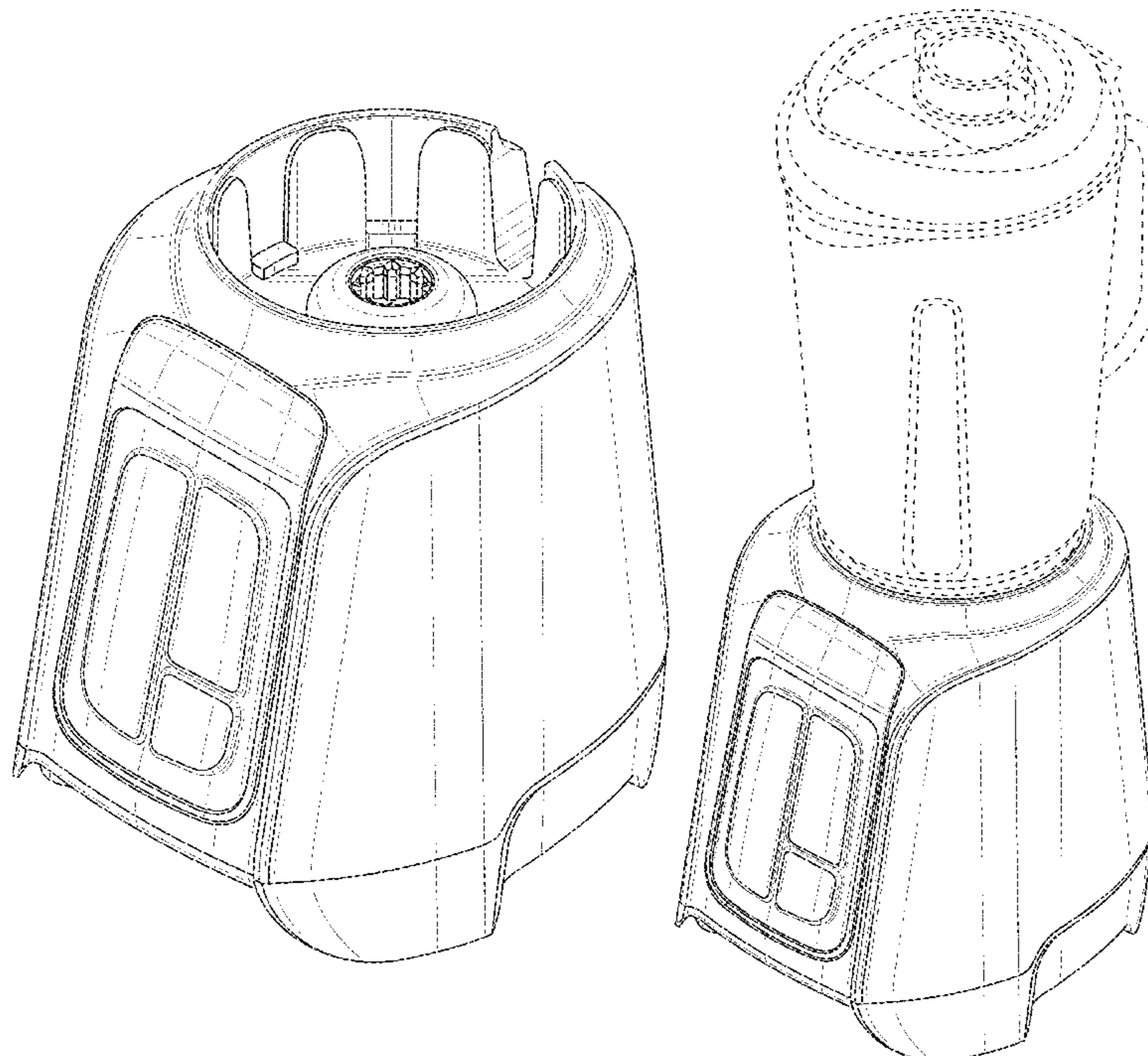

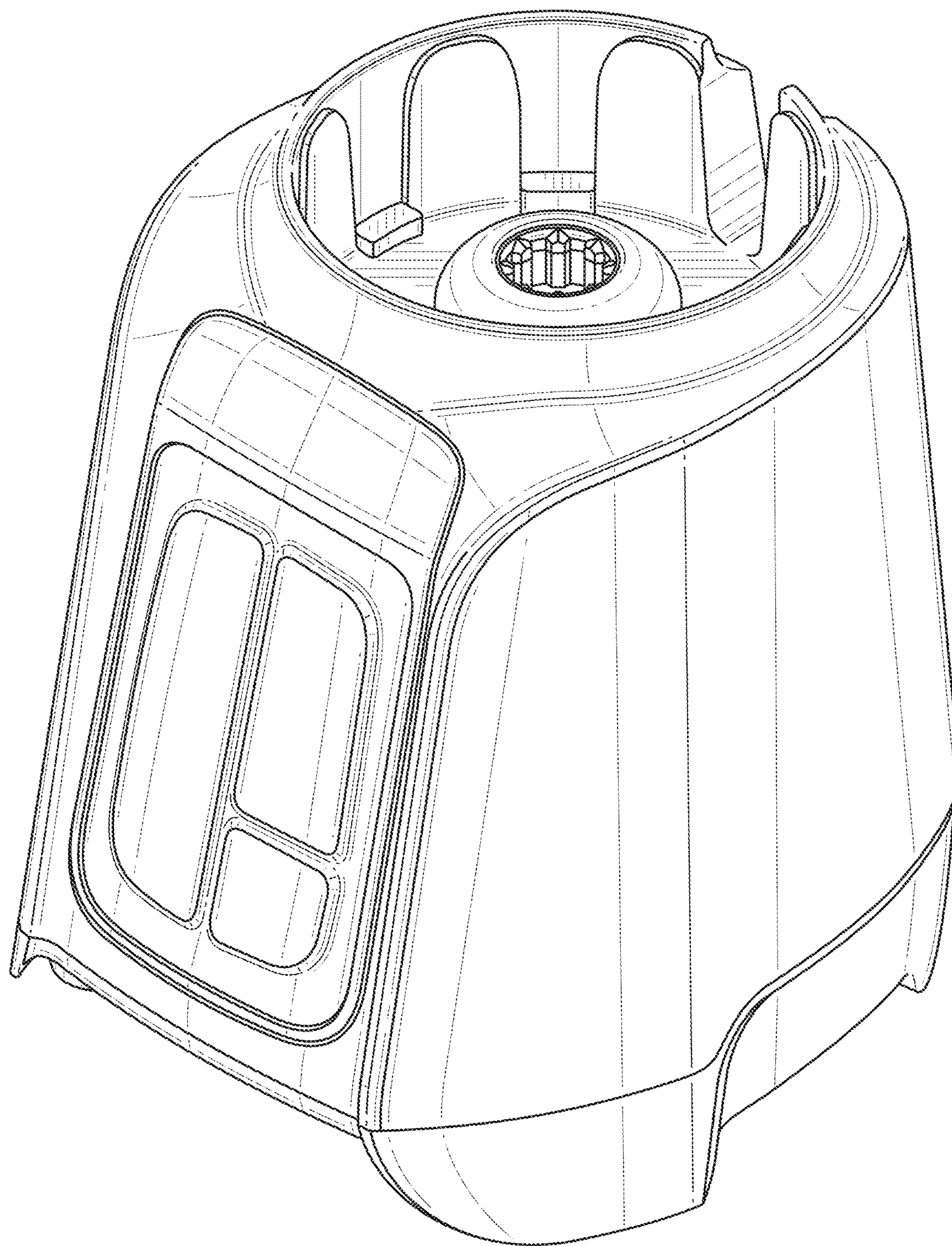

FIG. 1

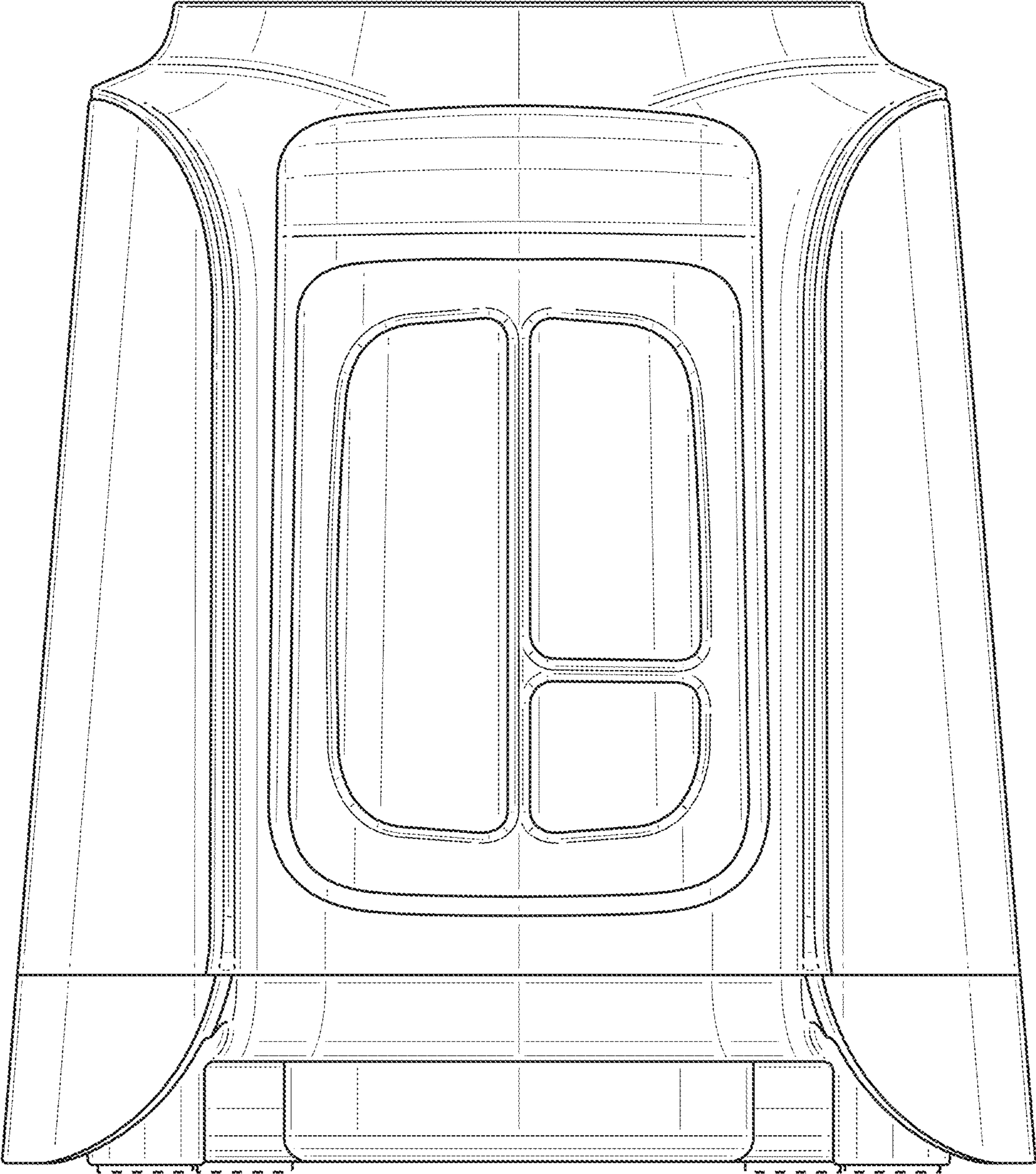

FIG. 2

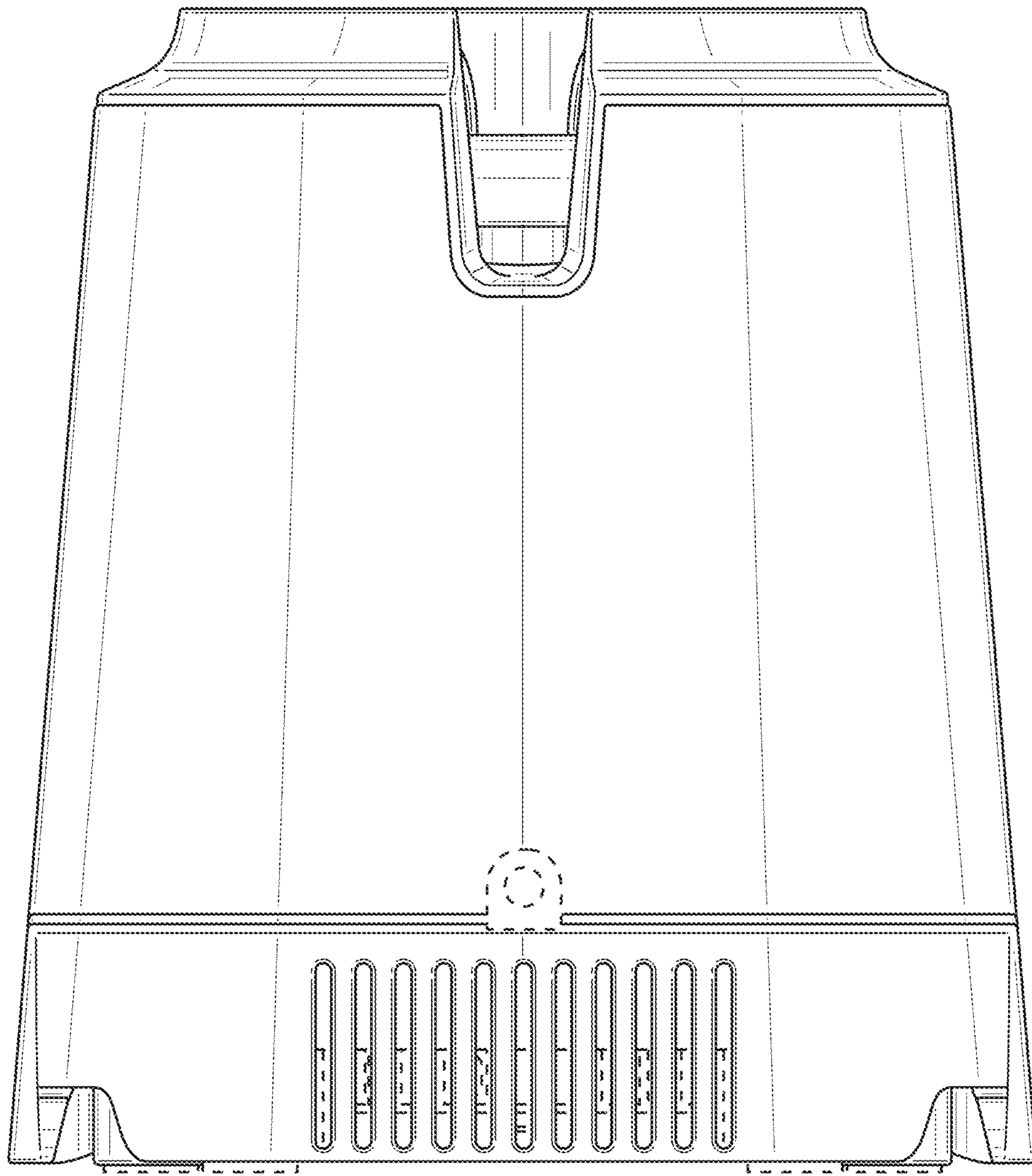

FIG. 3

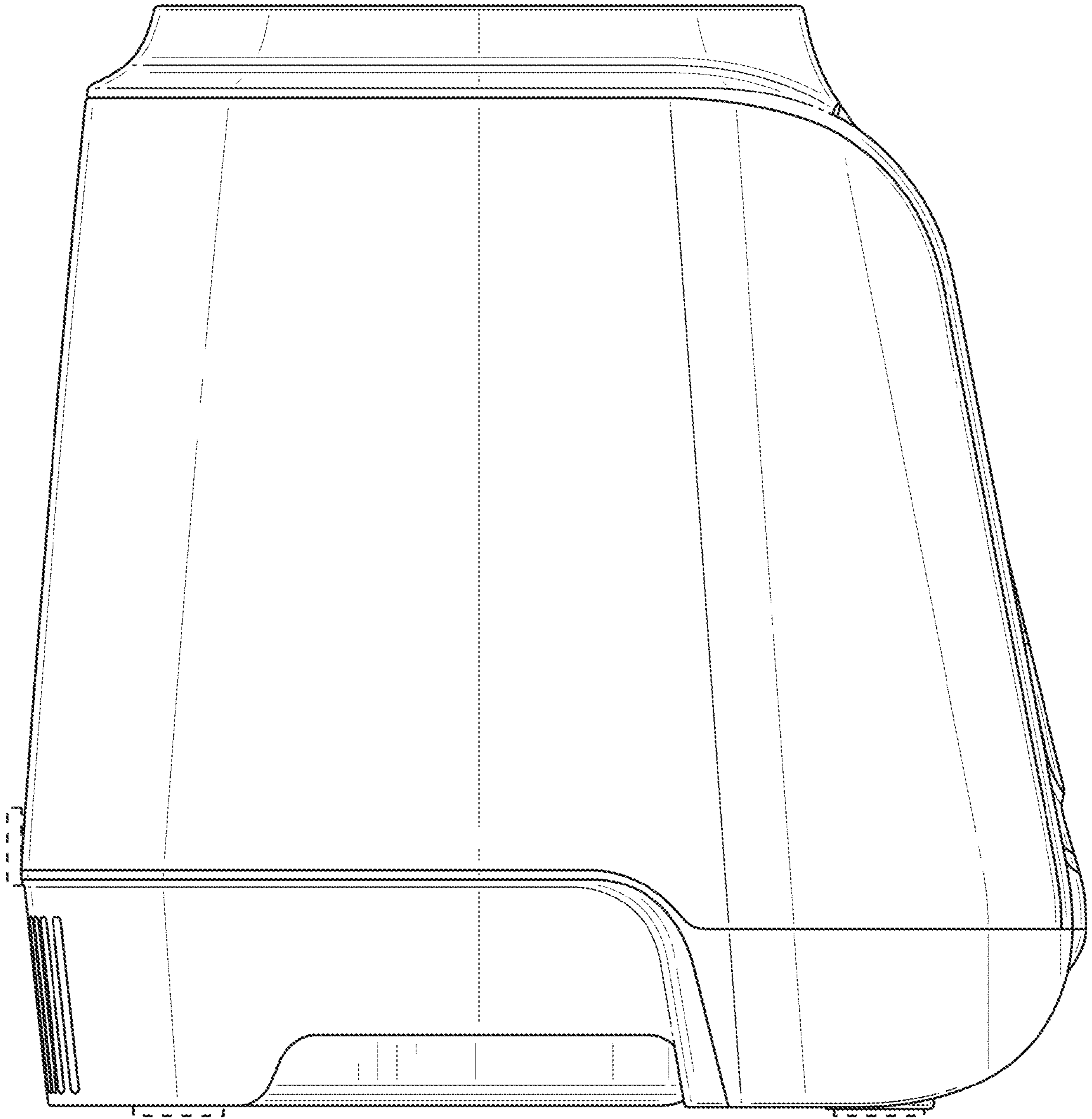

FIG. 4

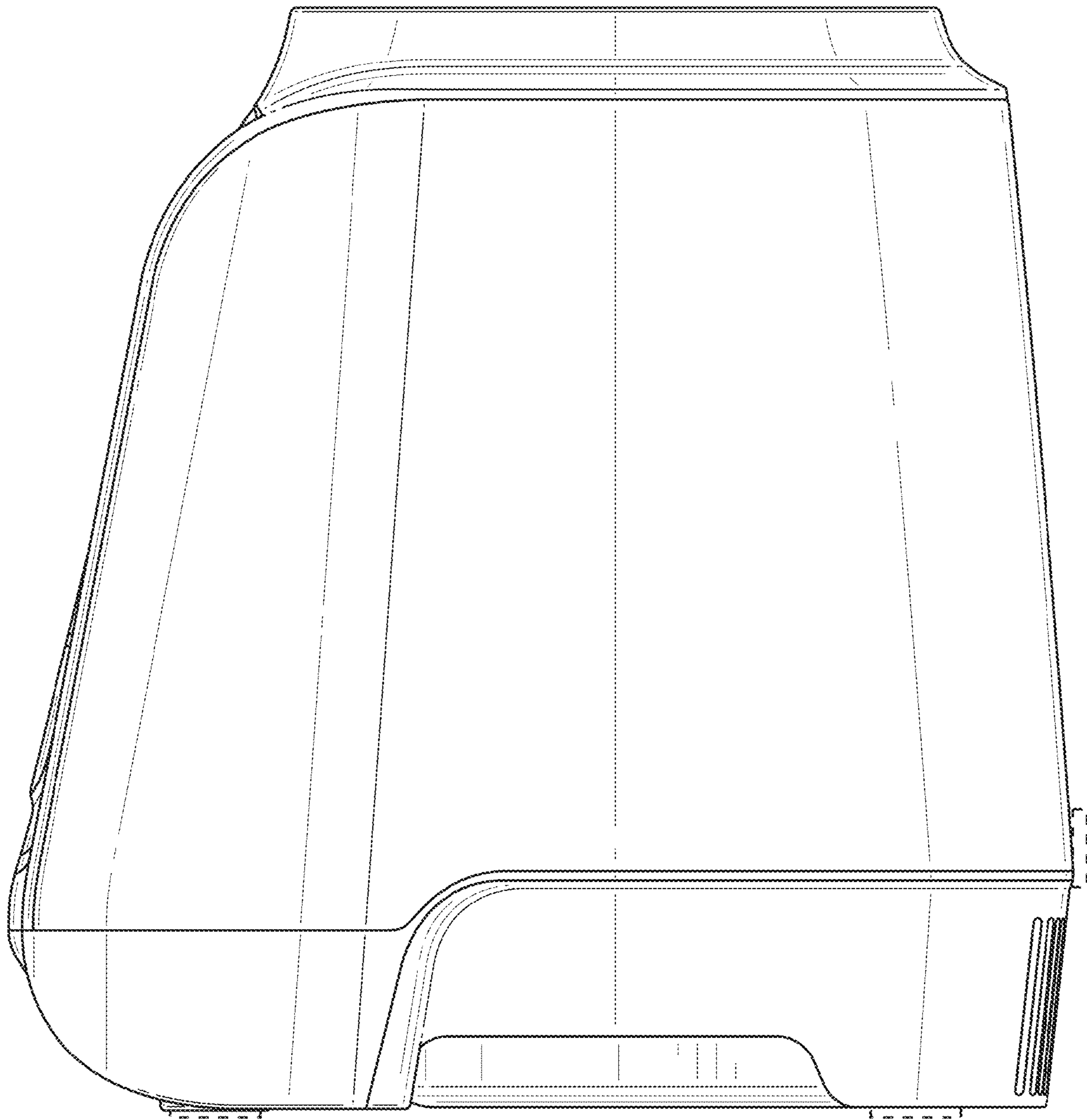

FIG. 5

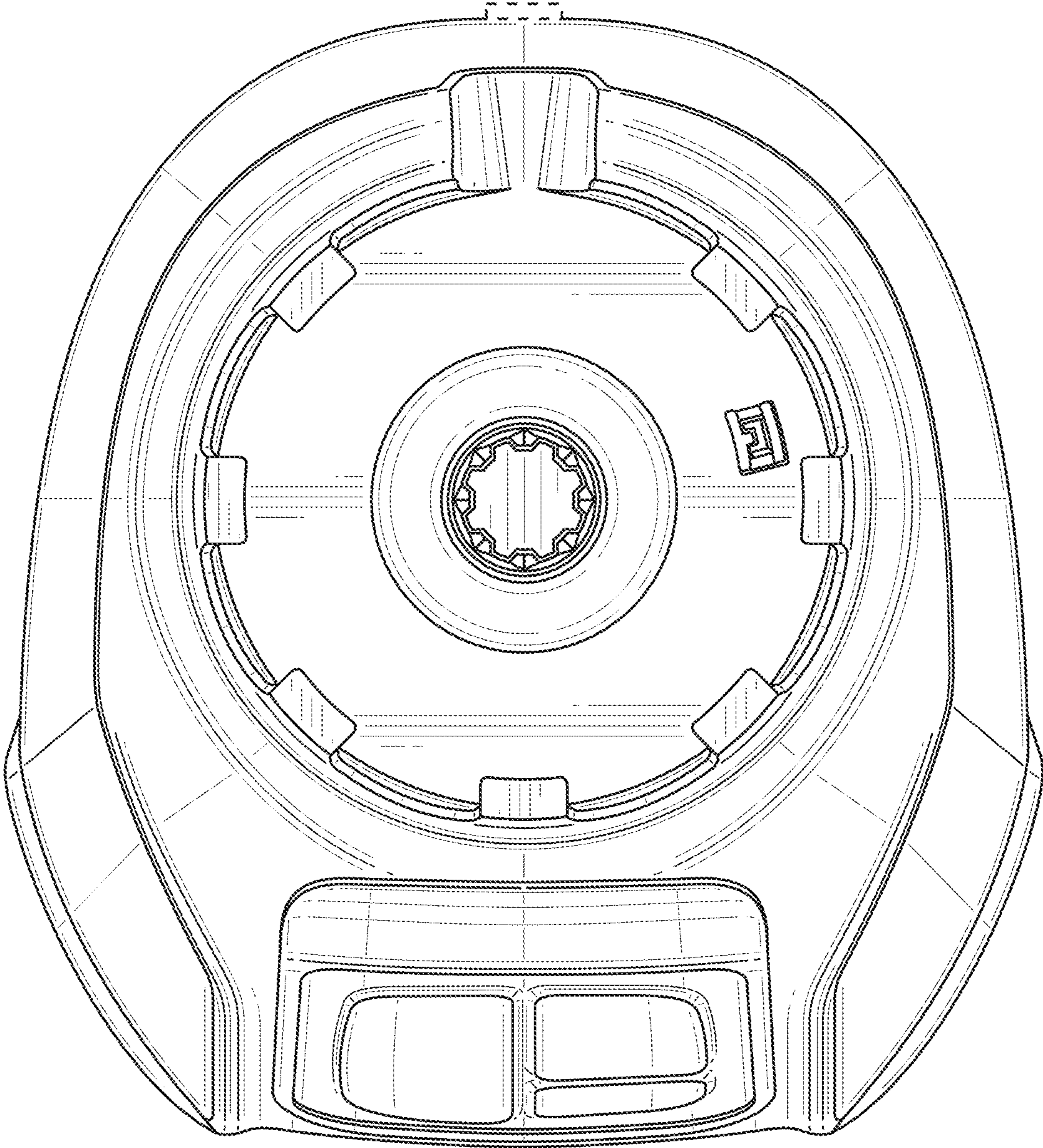

FIG. 6

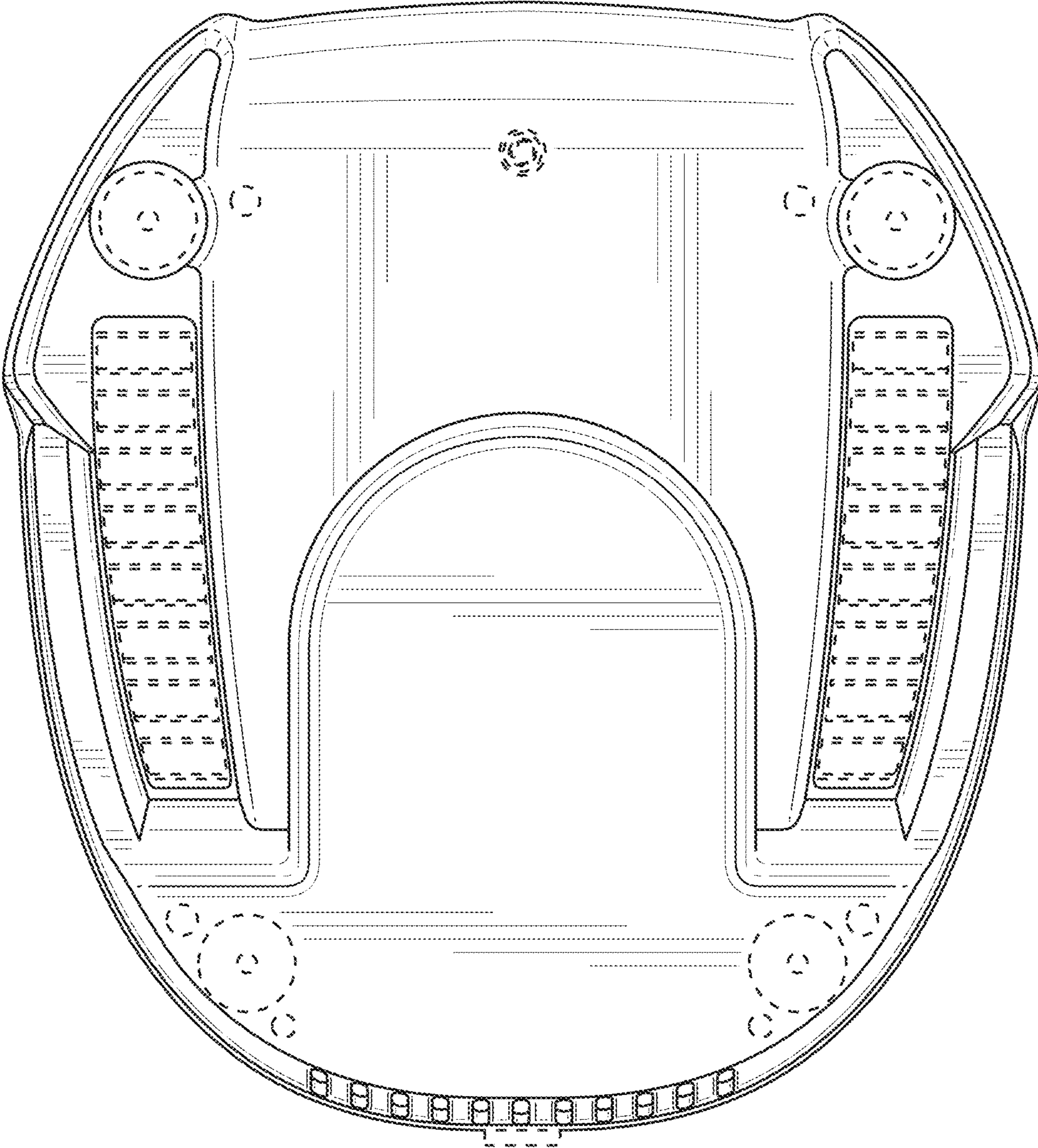

FIG. 7

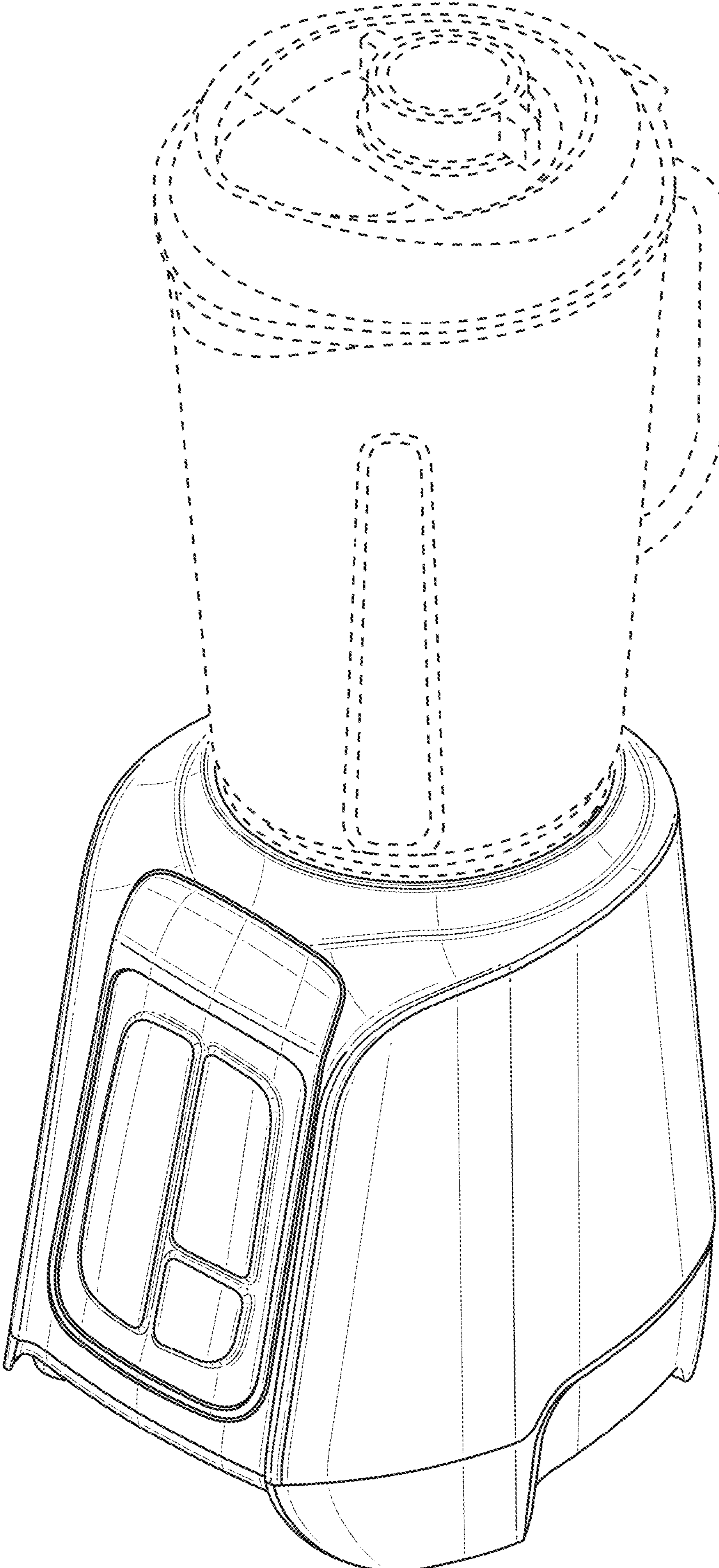

FIG. 8